

H
655-2

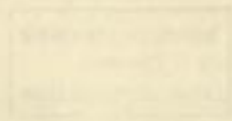

32
655
Atlas





Handwritten text, possibly a signature or date, written vertically in the center of the page.



Technische Universität
Chemnitz
Universitätsbibliothek

WA H655-2



SLUB

Wir führen Wissen.

<http://digital.slub-dresden.de/id446692875/4>



TECHNISCHE UNIVERSITÄT
CHEMNITZ

*Heften nicht mehr möglich.
statt dessen
F = 1,235 SW
SW = 1,4 d + 1 mm*

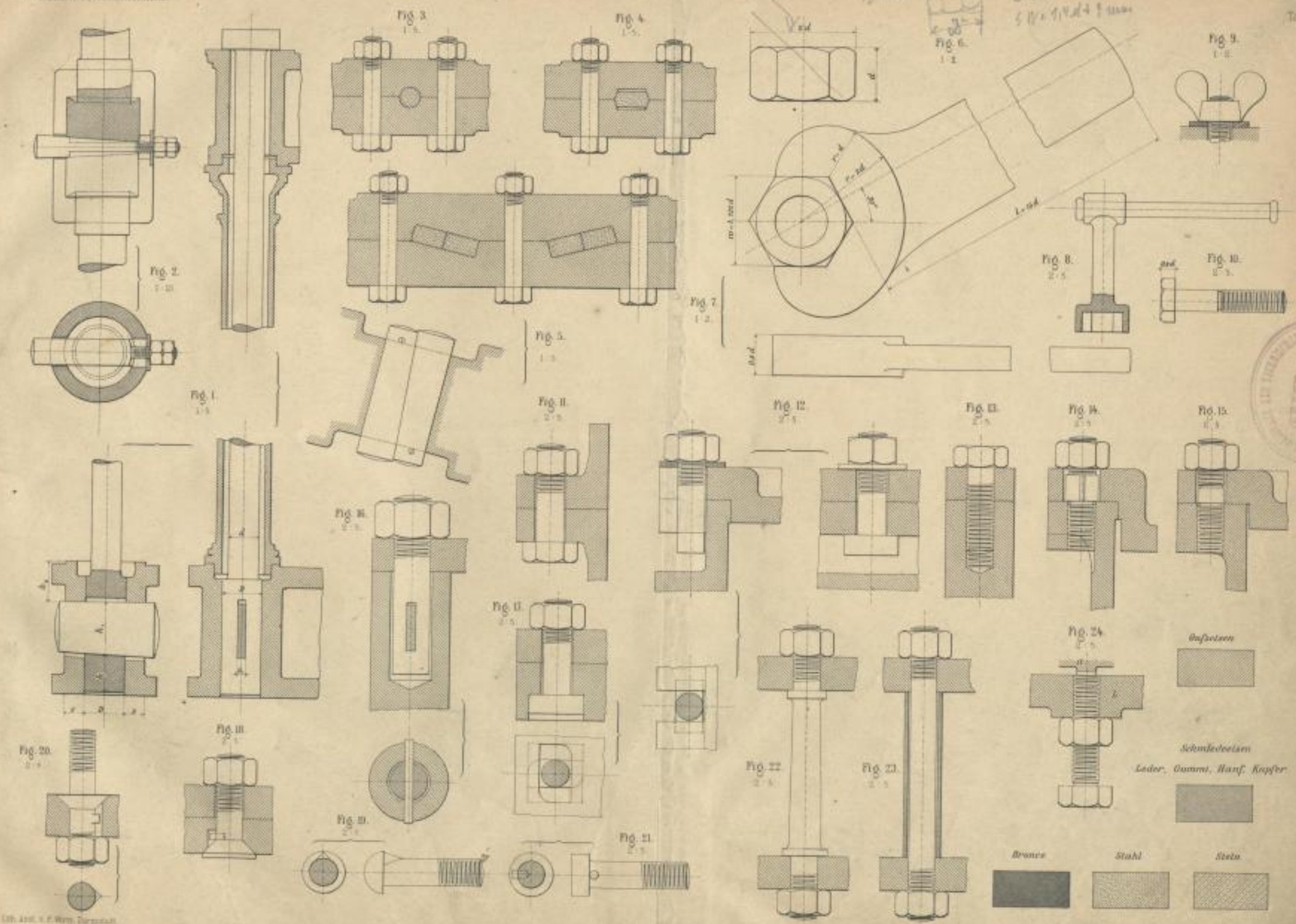

Dr. Ing. v. P. W. W. W. W.

Alles



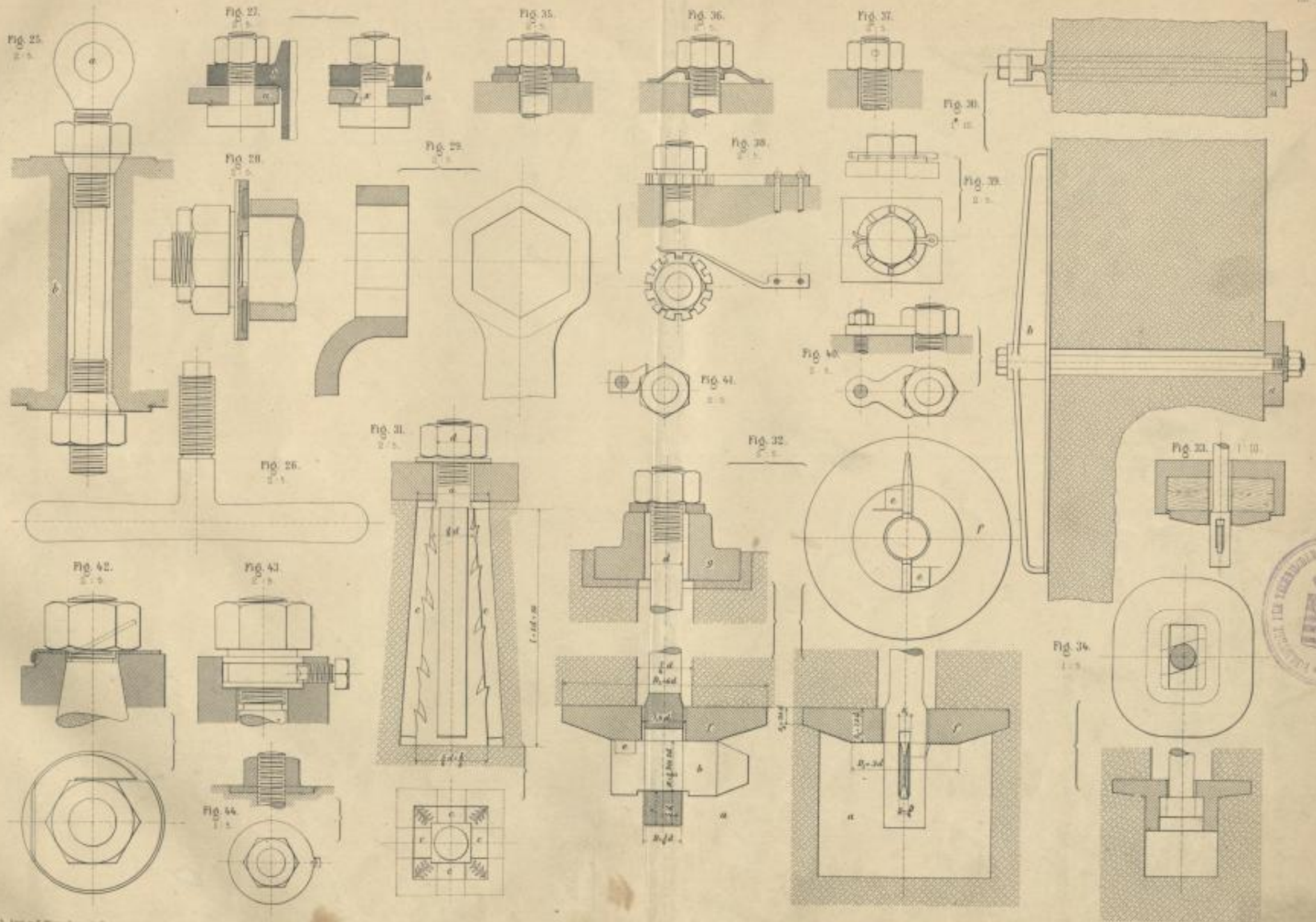

Lab. Ann. v. F. Wenz, Darmstadt



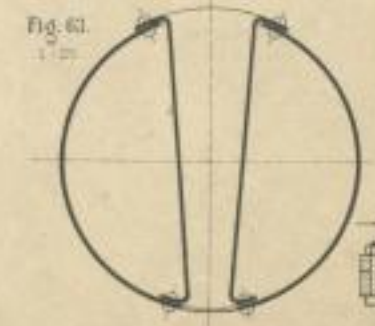
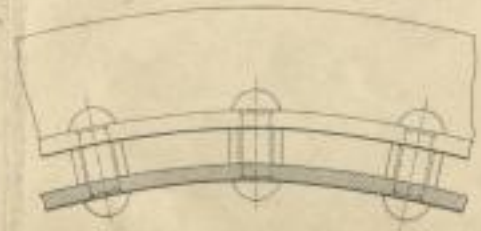
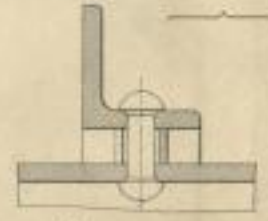
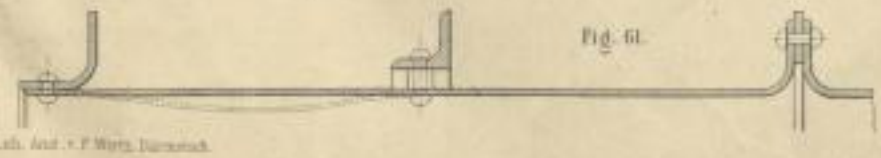
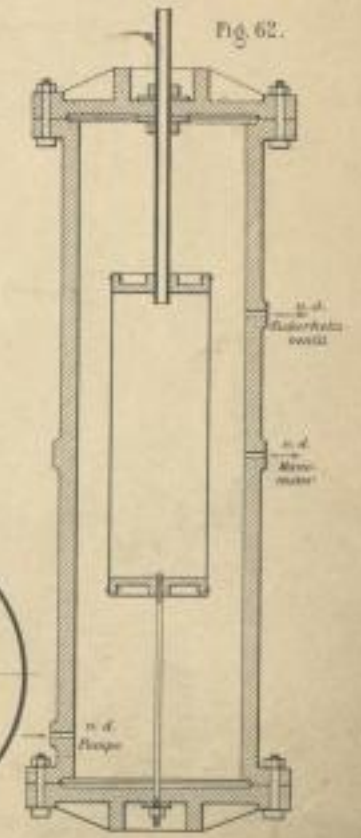
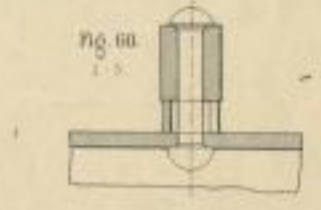
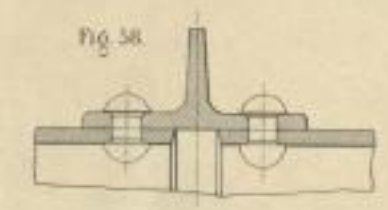
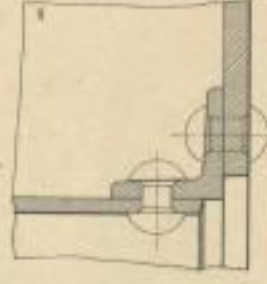
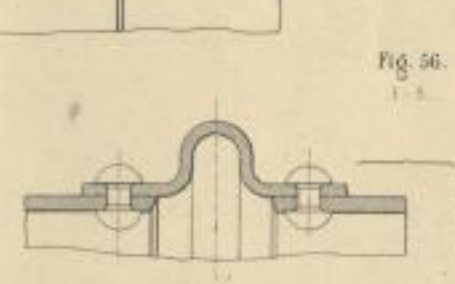
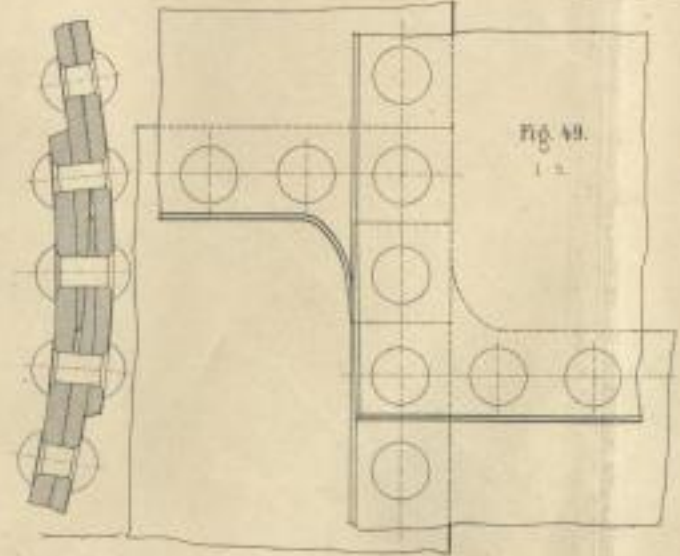
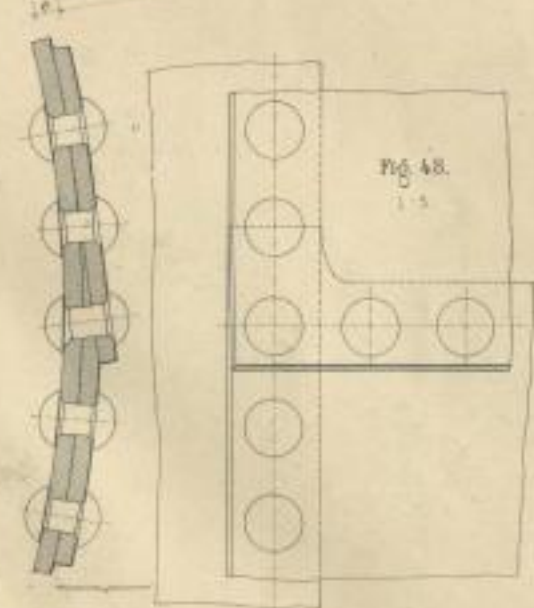
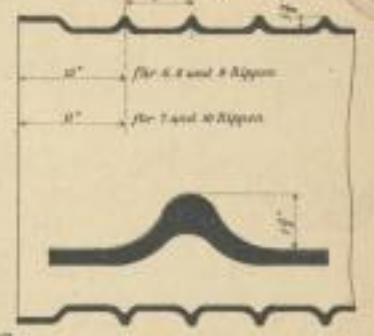
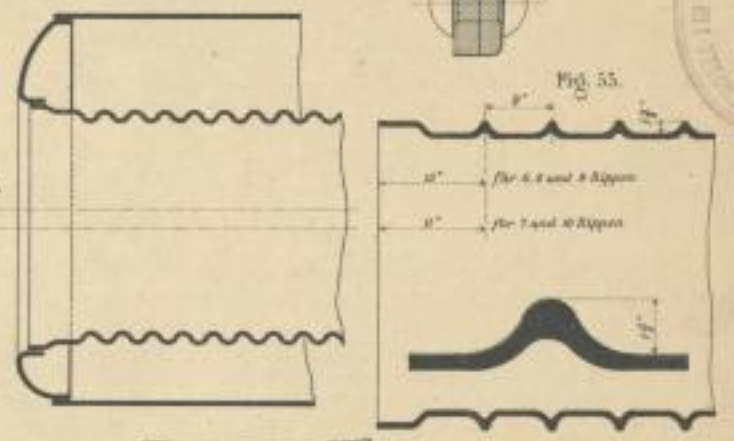
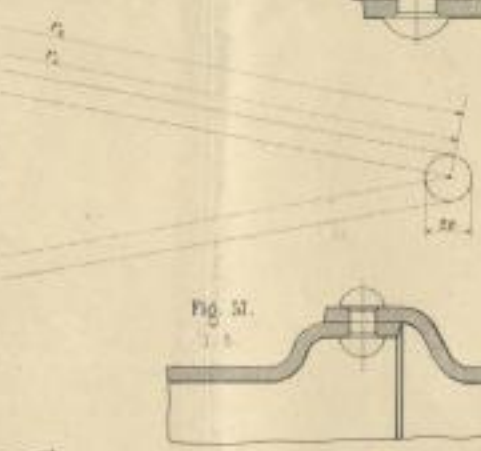
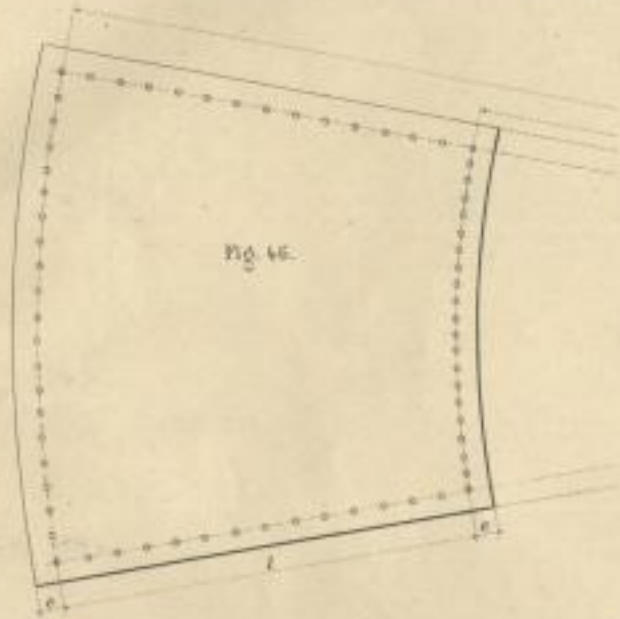
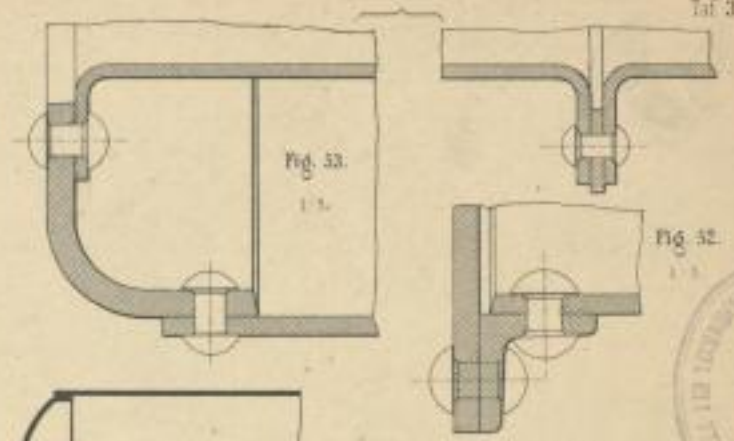
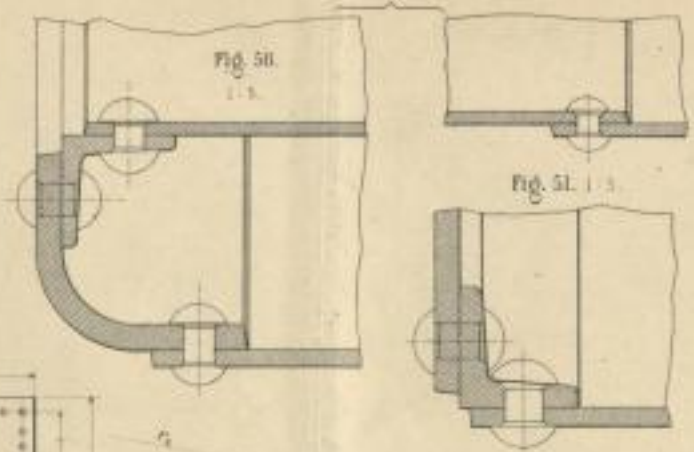

Lab. Anst. v. F. Witt, Darmstadt



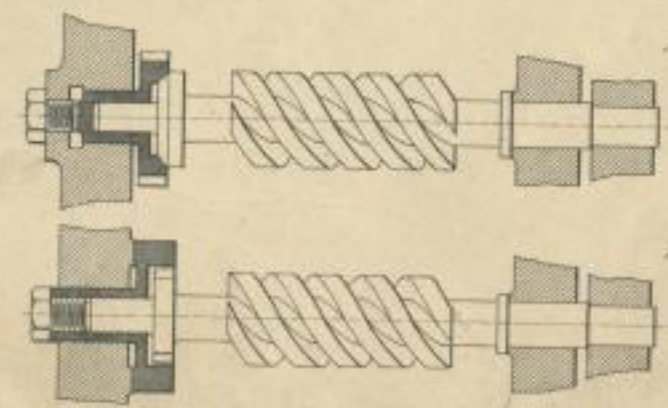
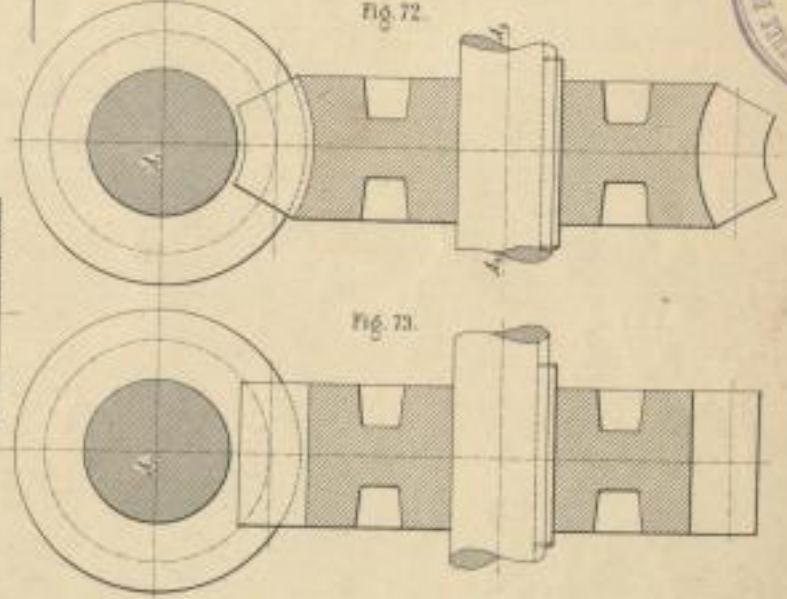
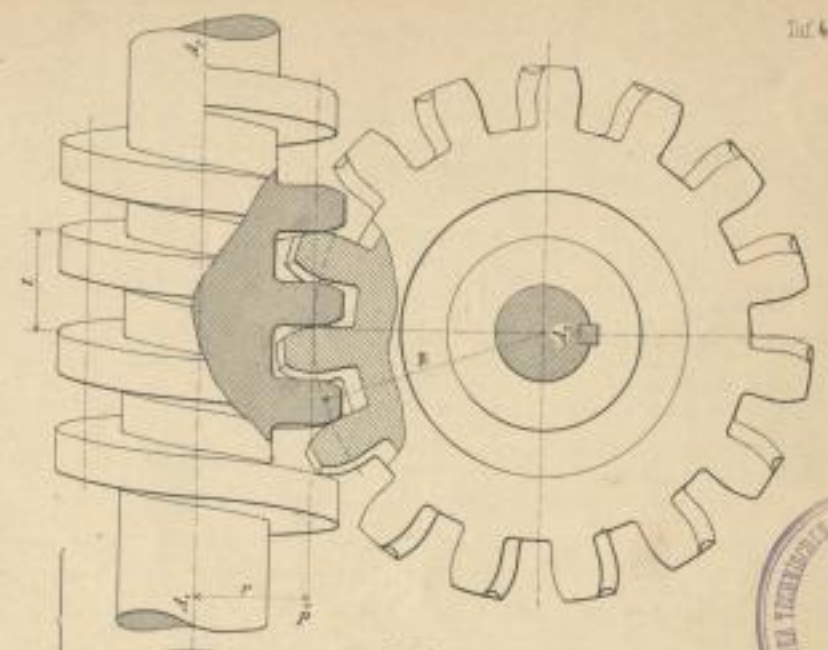
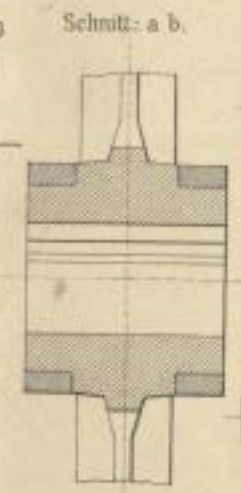
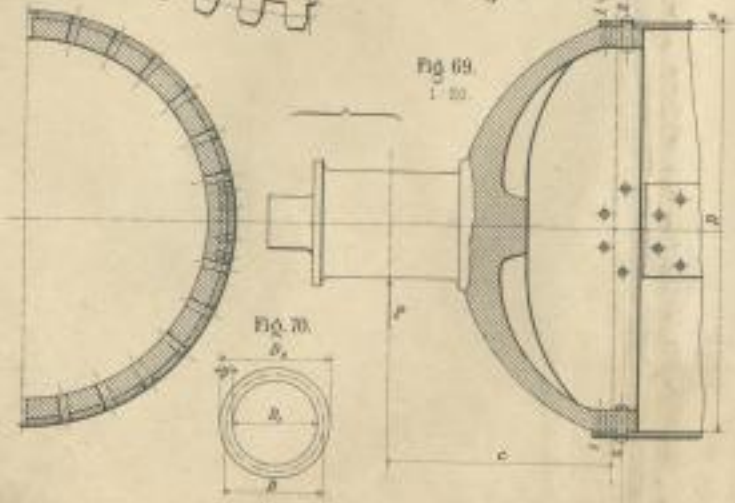
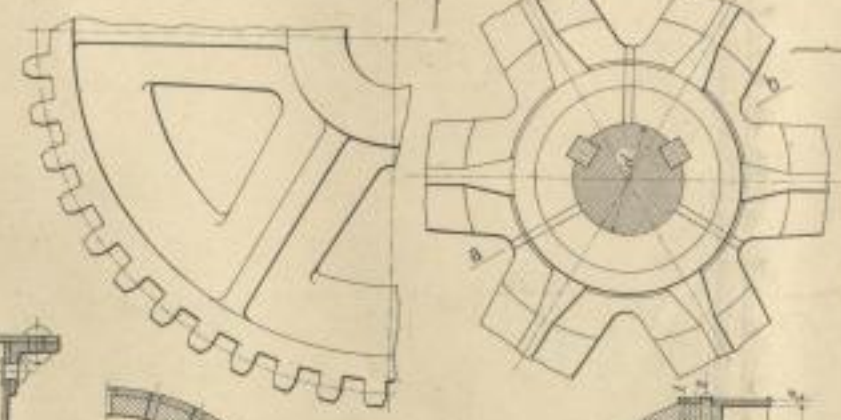
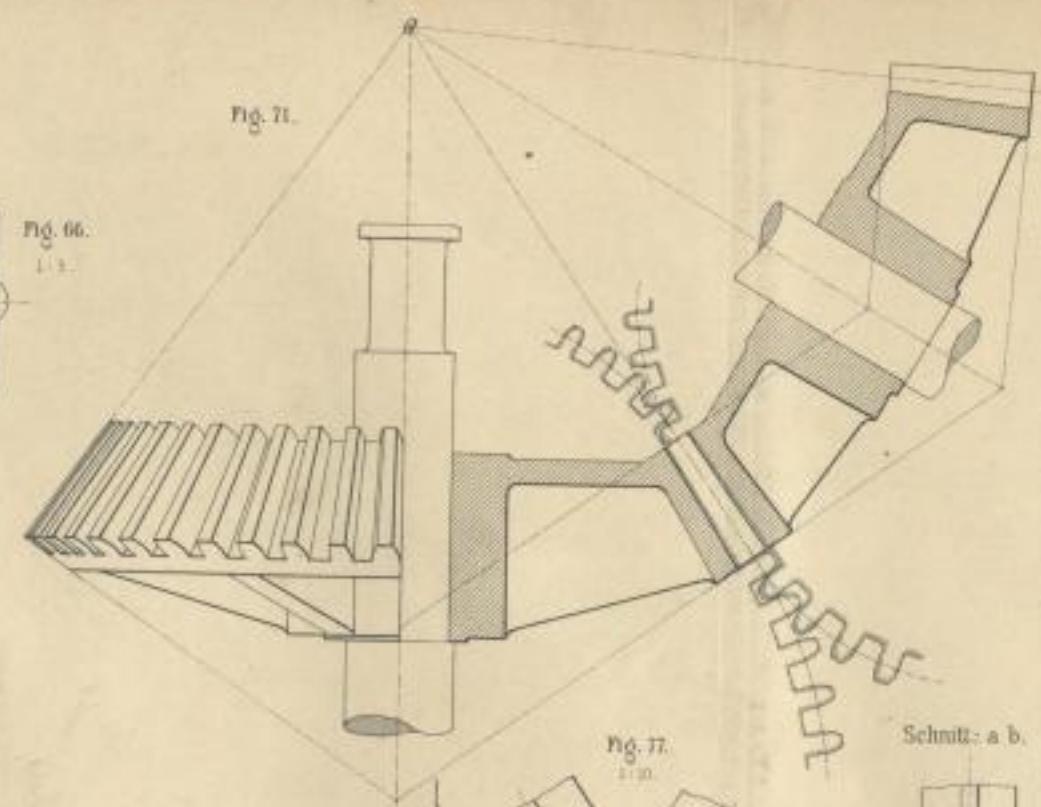
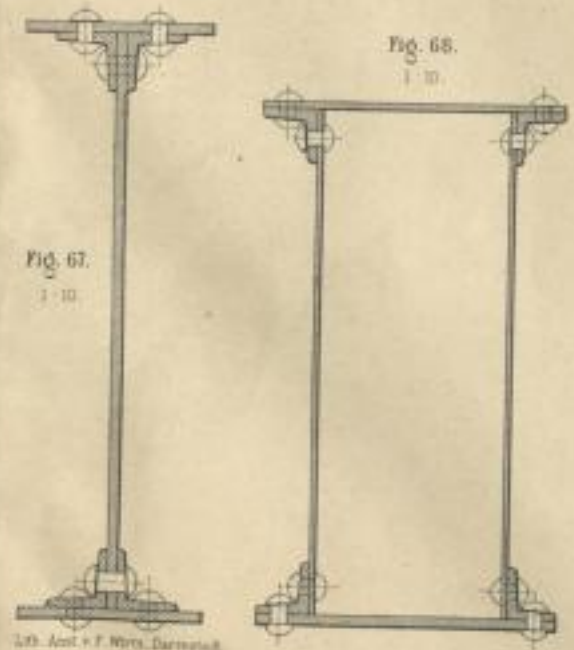
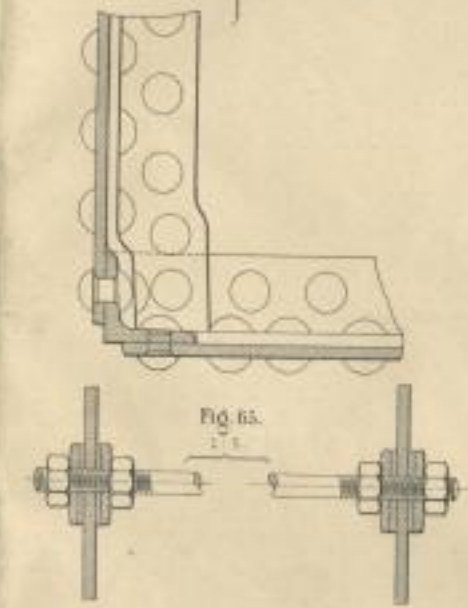
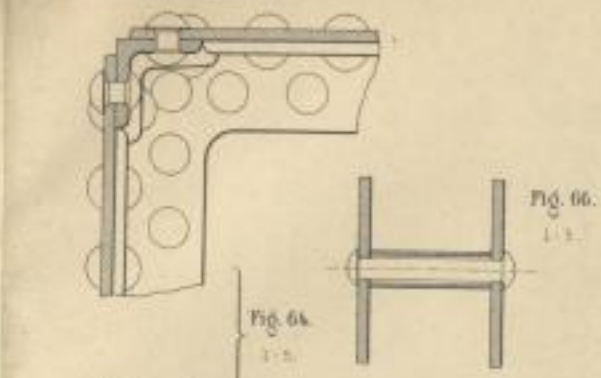

Lith. Anst. v. F. Weyl, Darmstadt.

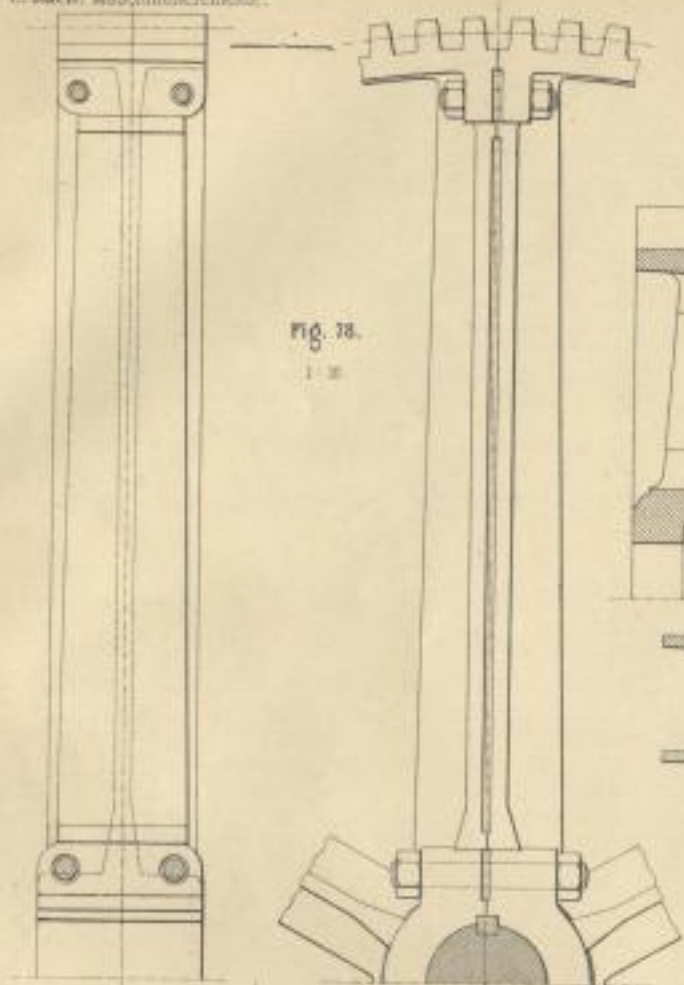

Fig. 76.
1:10

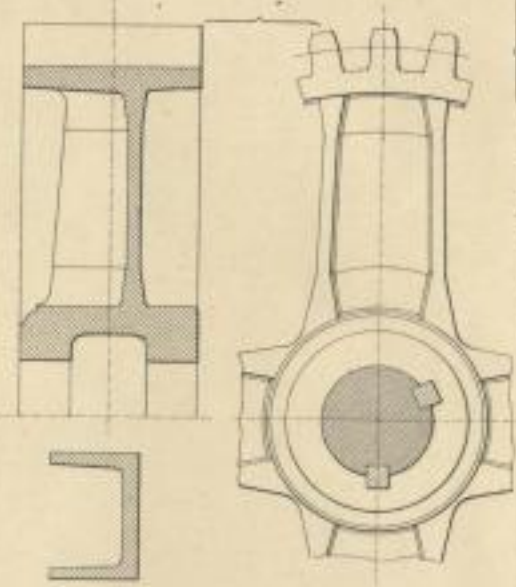

Fig. 80.



Fig. 86.

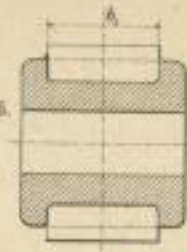

Fig. 79.

1:10.

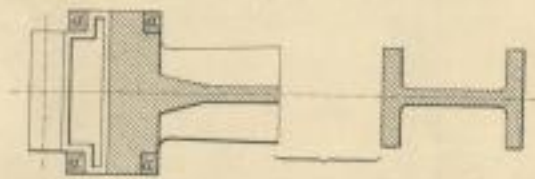

Fig. 81.

1:10.

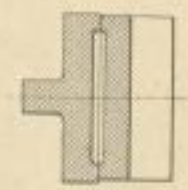

Fig. 82.

1:10.

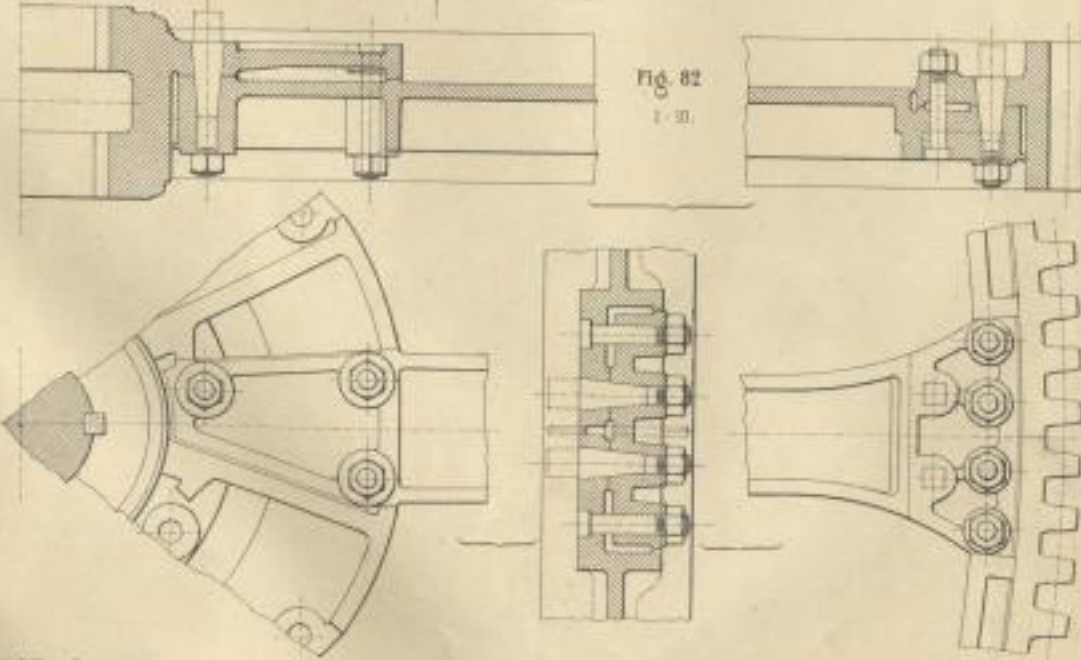

Fig. 90.
1:2.

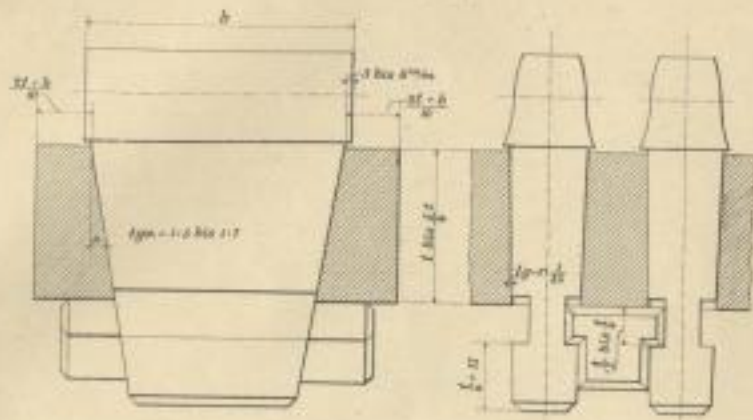

Fig. 91.
1:2.

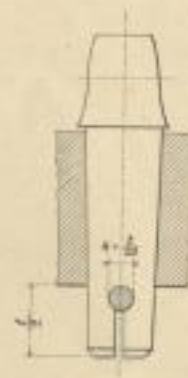

Fig. 95.
1:2.

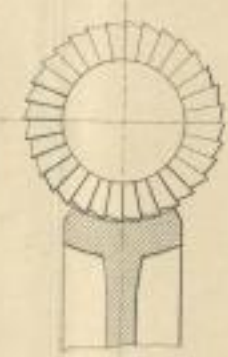
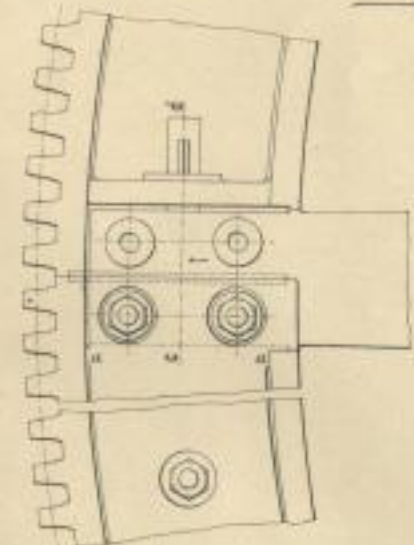
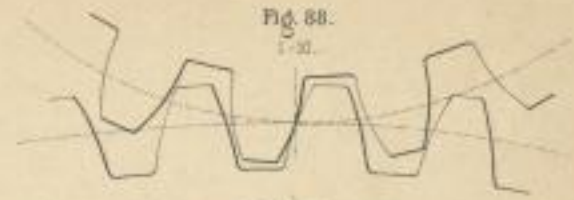

Fig. 88.
1:20.



Schnitt c.d. in der Pfeilrichtung gesehen.

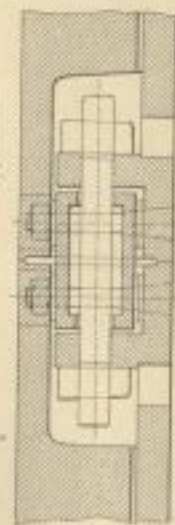

Fig. 83.
1:20.

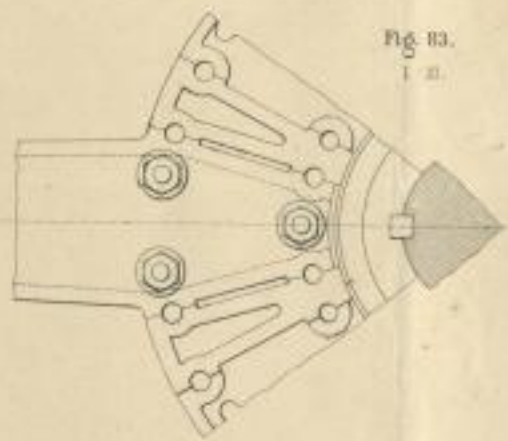

Fig. 94.
1:2.

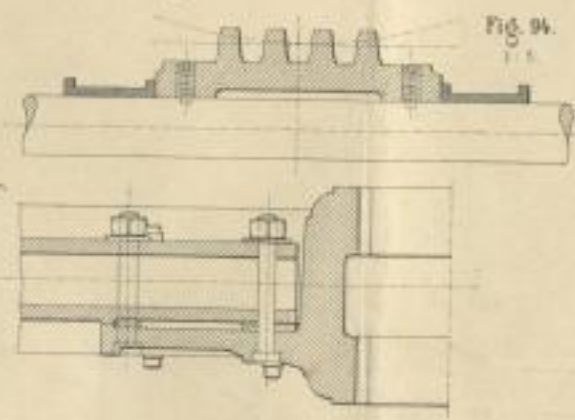
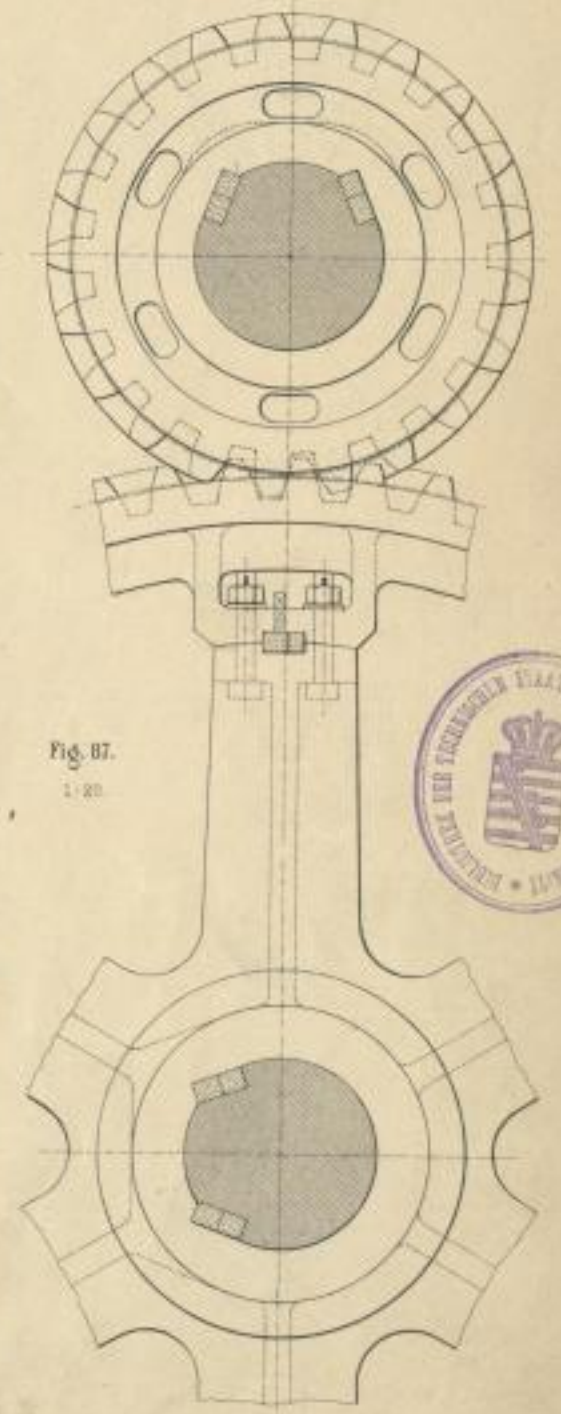

Fig. 87.
1:20.



120. Abb. v. F. Wirtz, Darmstadt.



SLUB

Wir führen Wissen.

<http://digital.slub-dresden.de/id446692875/16>



TECHNISCHE UNIVERSITÄT
CHEMNITZ

Fig. 89.
1:20.

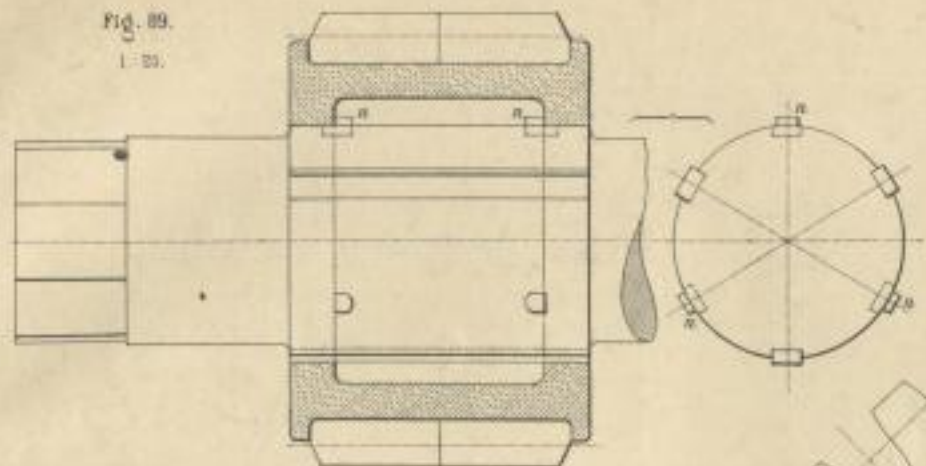
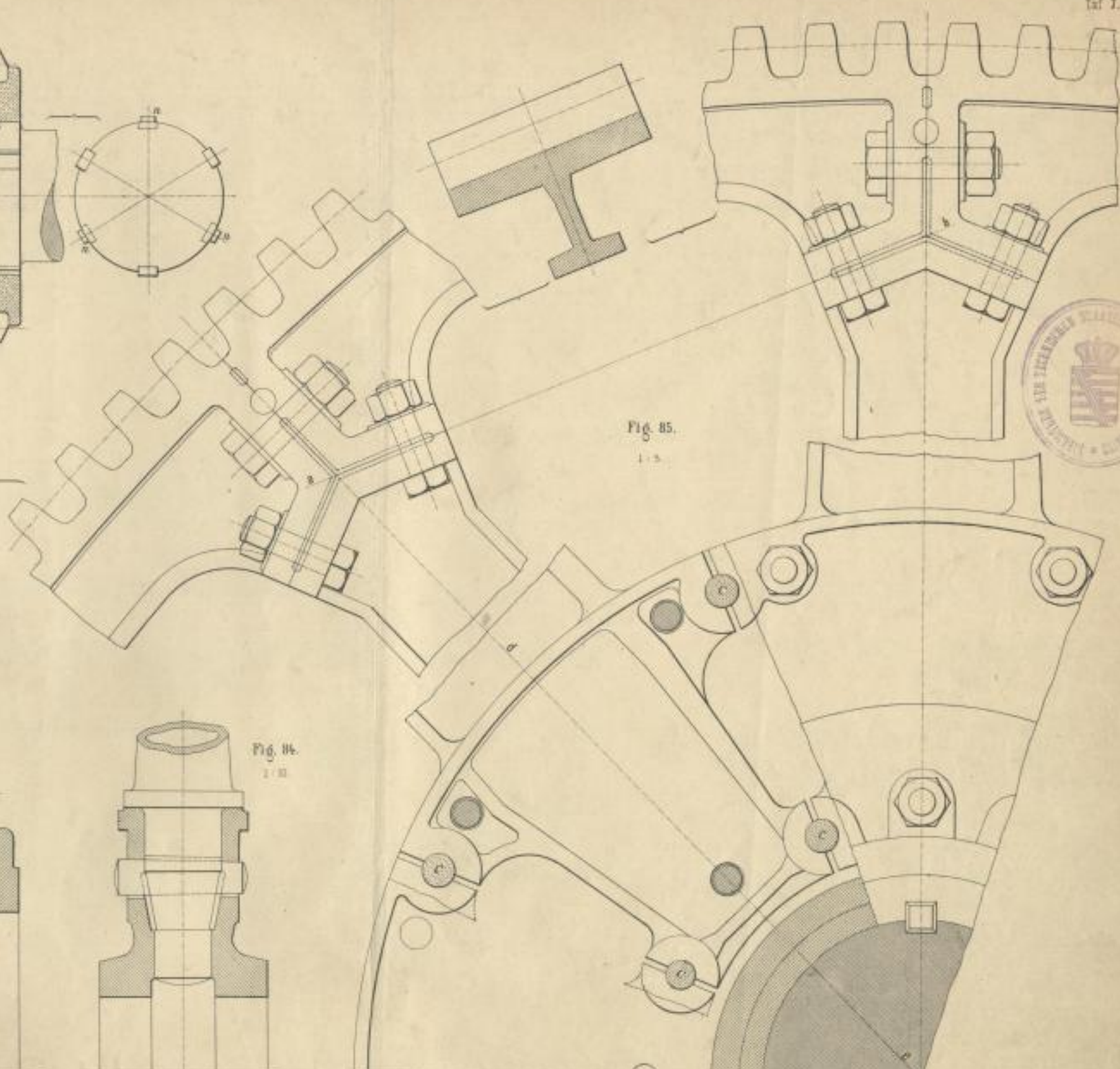

Fig. 85.
1:5



Schnitt:
d-e.

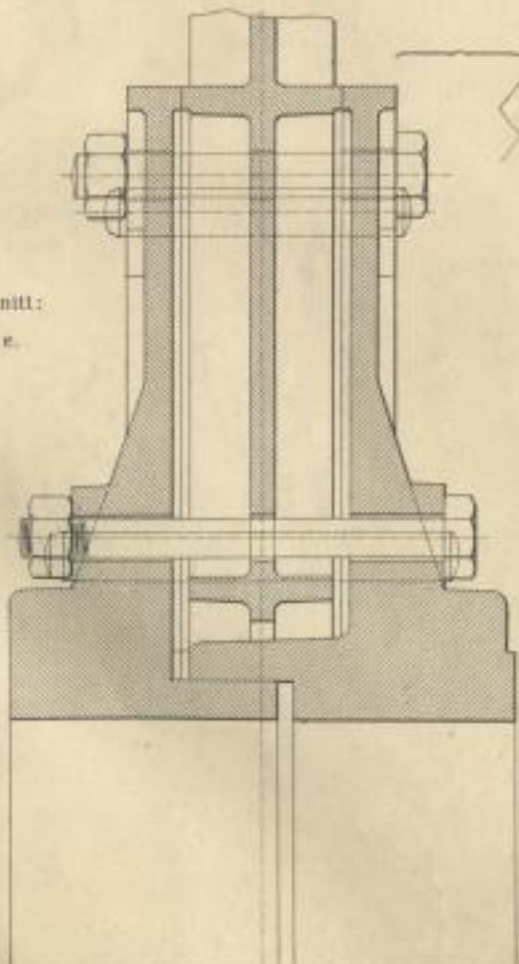
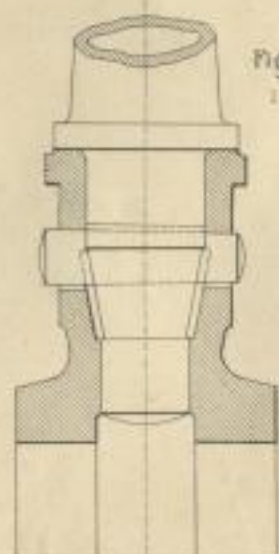
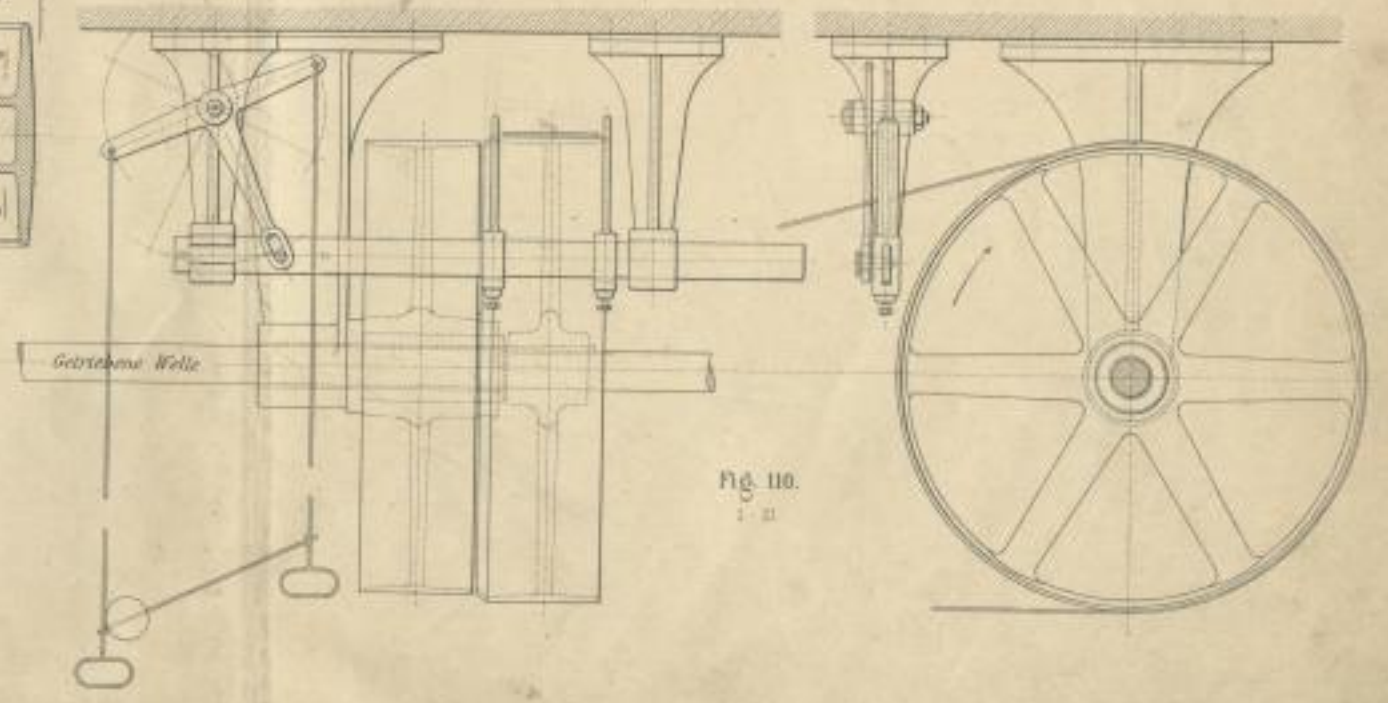
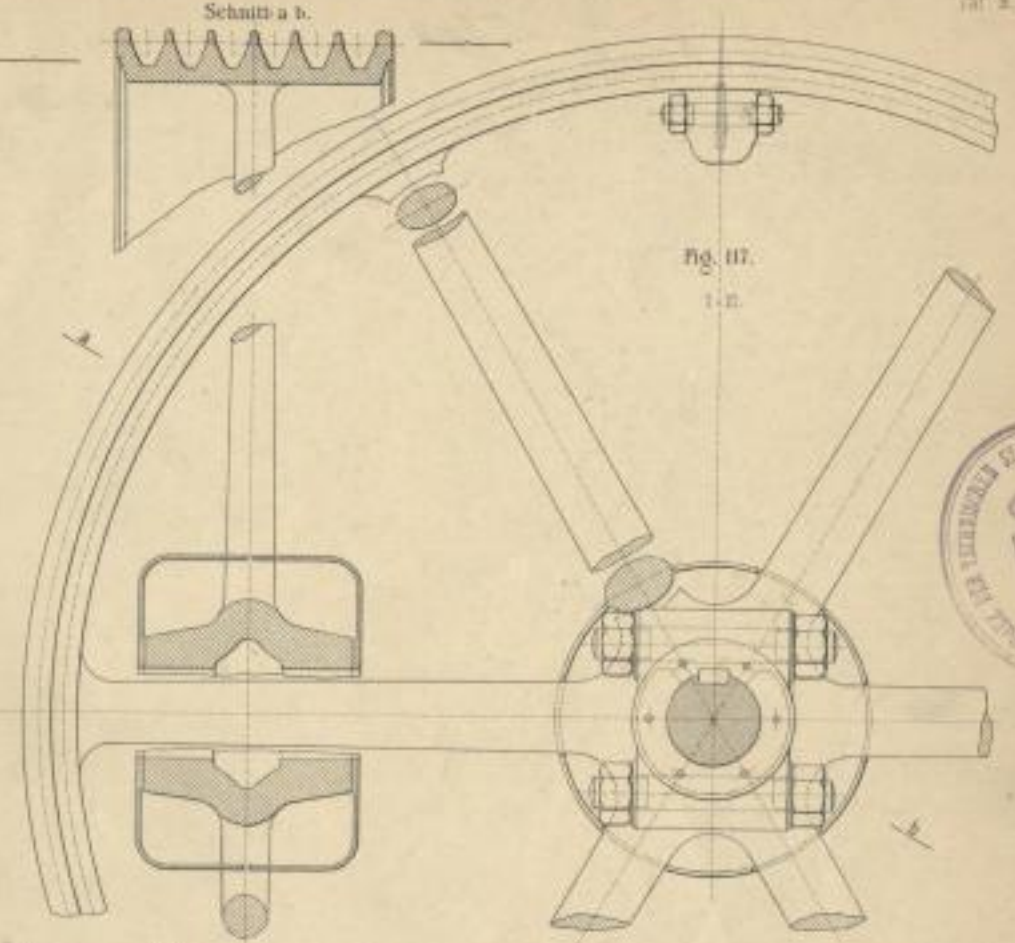
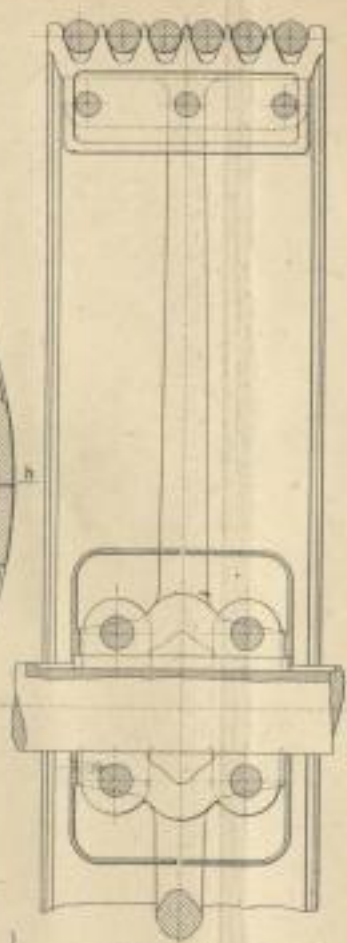
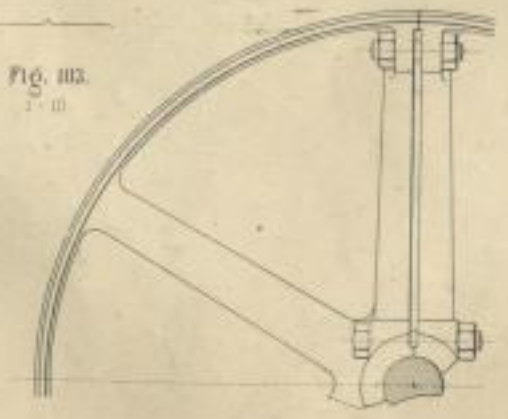
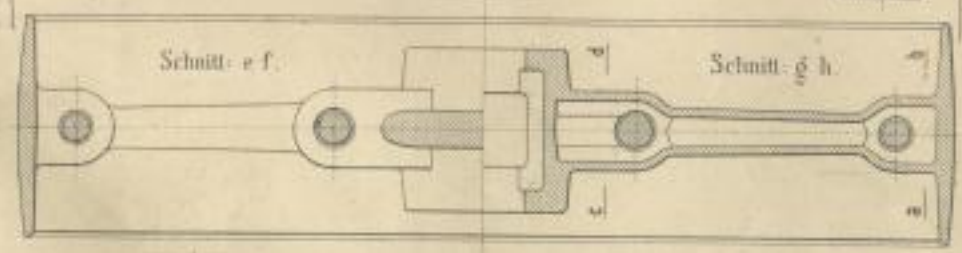
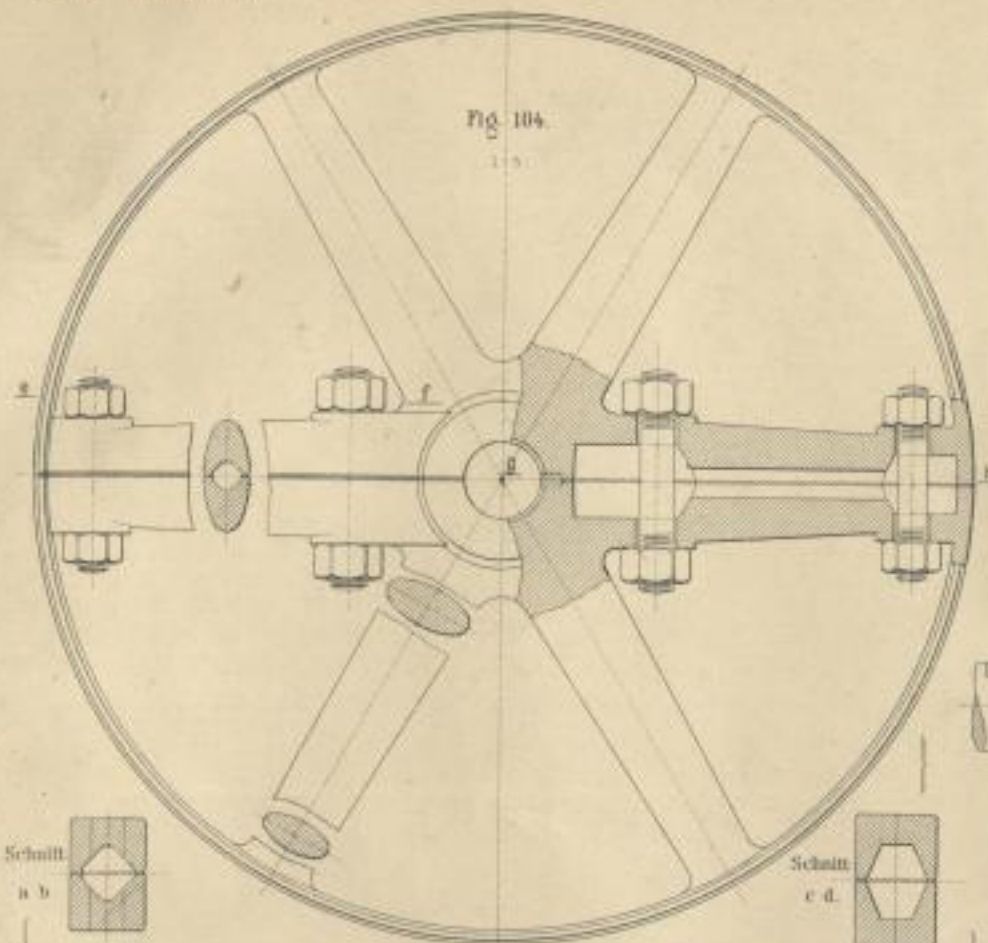

Fig. 86.
1:30



Lab. 800 + 7. Fern. Darmstadt



Lith. Anst. v. F. Witz, Bamberg

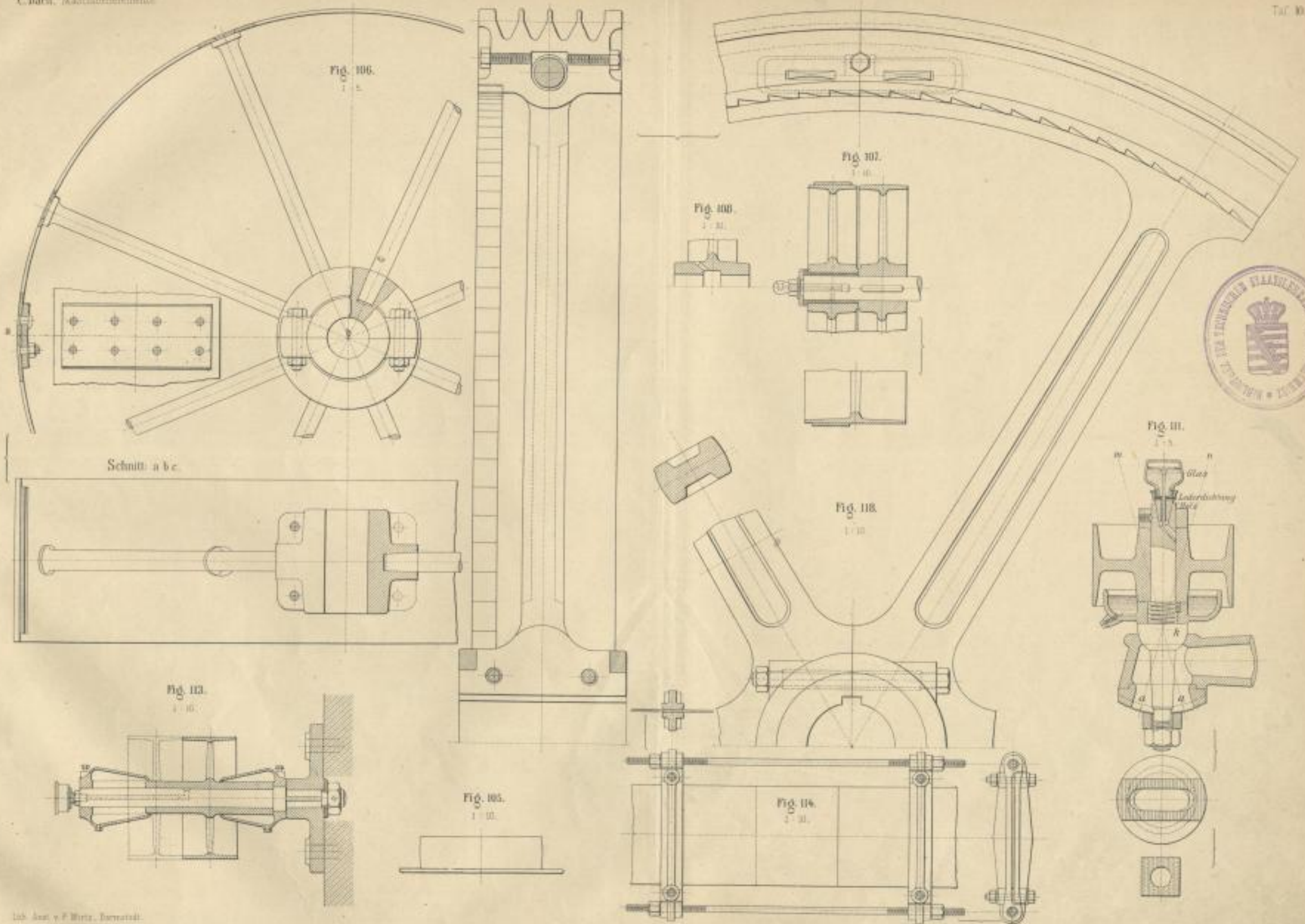

Lith. Anst. v. F. Witz, Dresden.

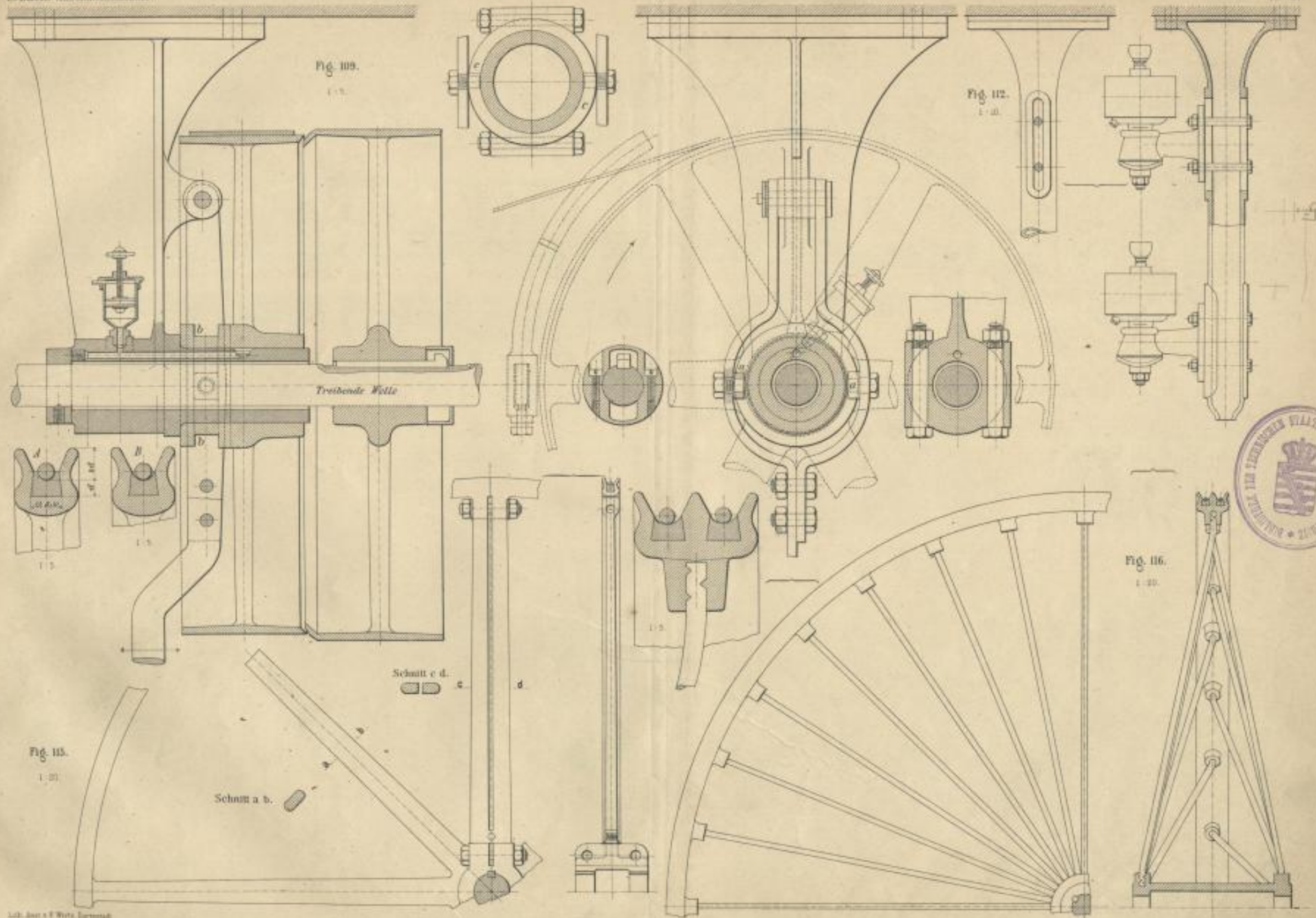

Lith. Anst. v. F. Witz, Darmstadt.



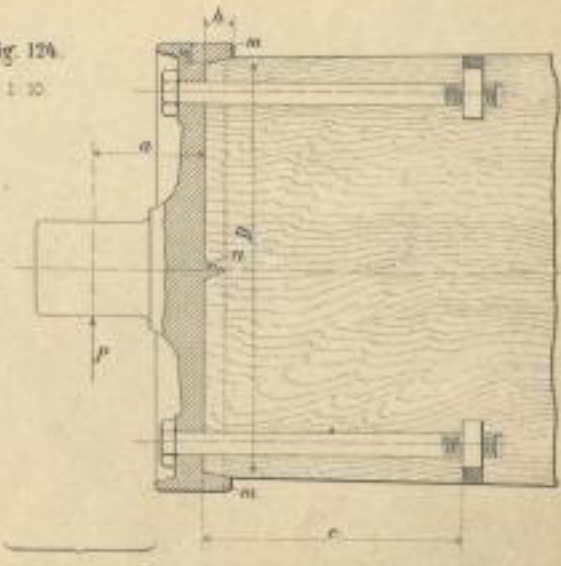
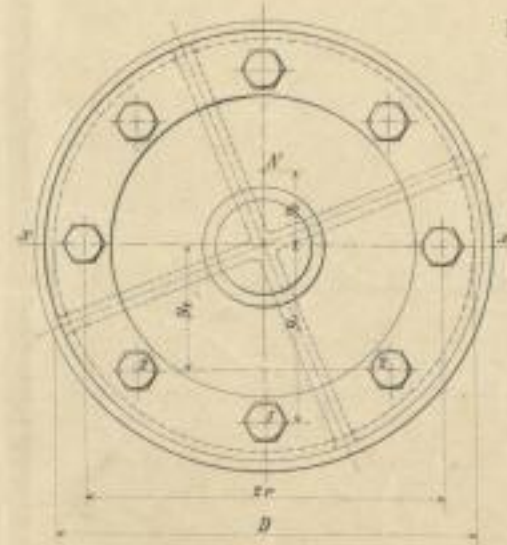
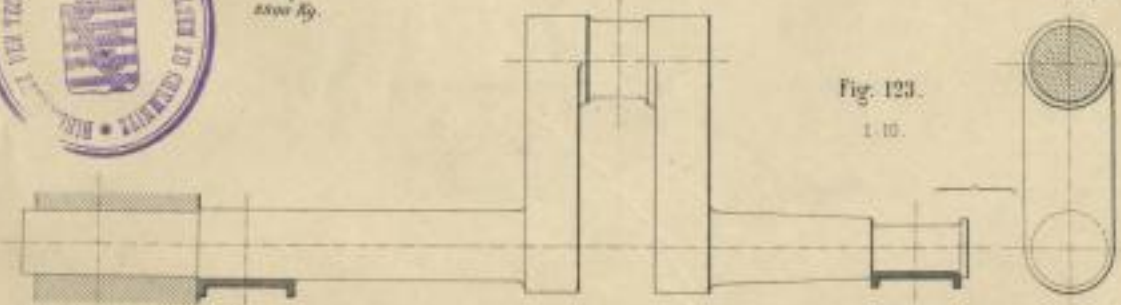
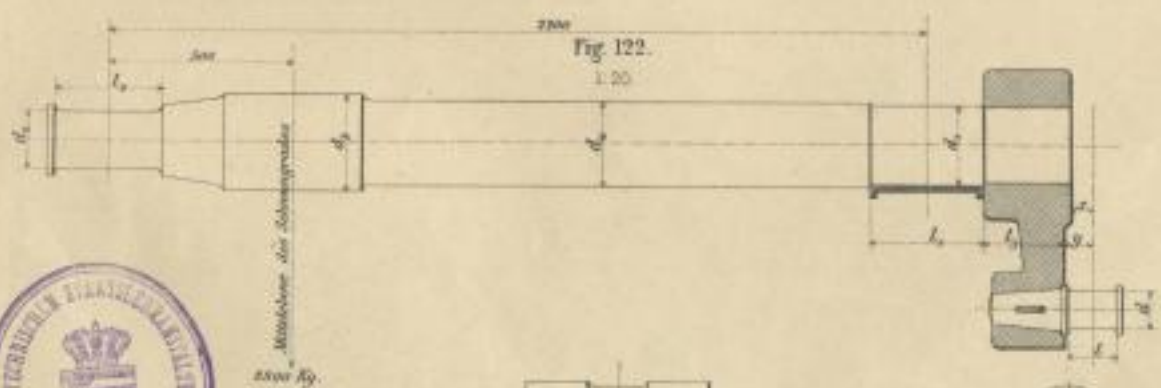
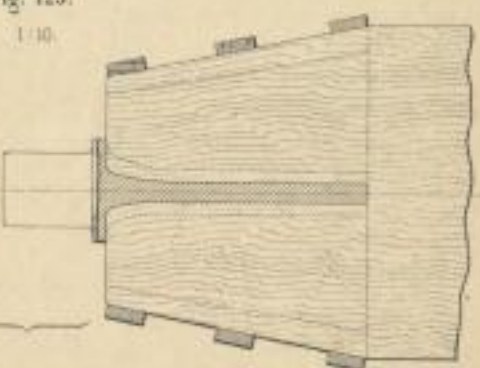
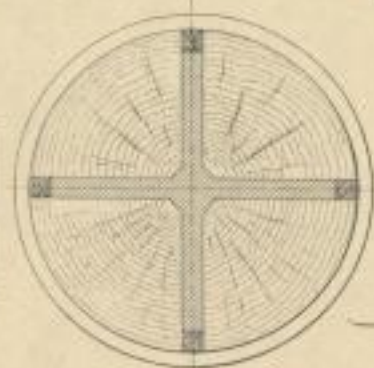
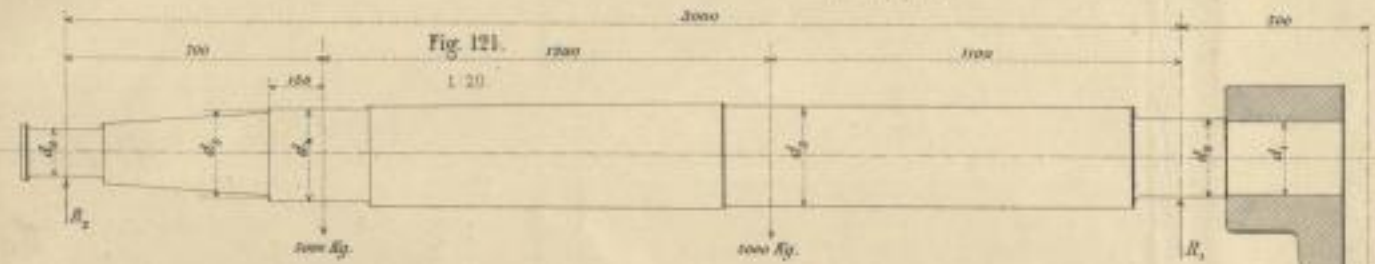
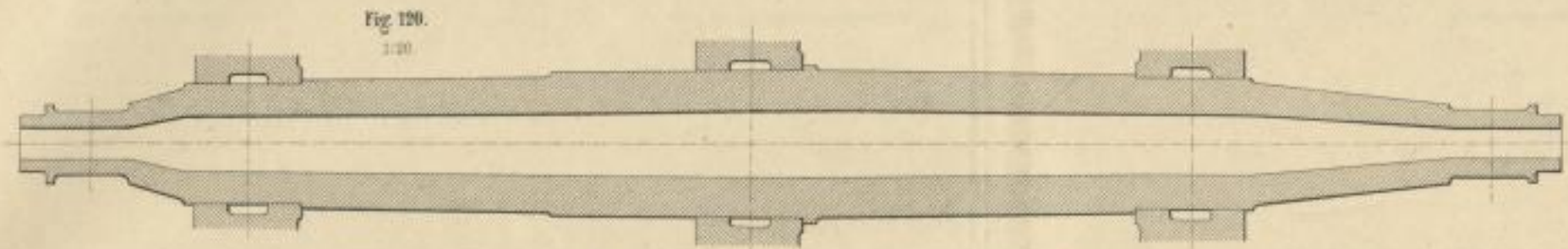
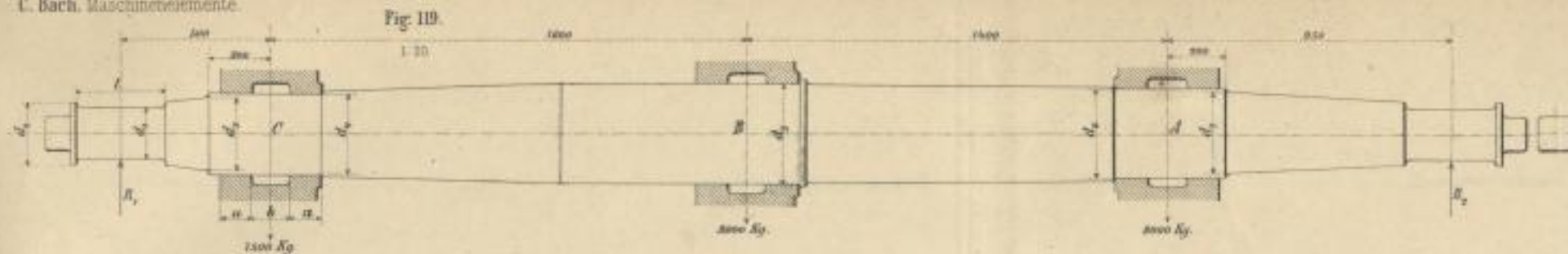

Lith. Anst. v. F. Weis, Darmstadt



SLUB

Wir führen Wissen.

<http://digital.slub-dresden.de/id446692875/30>



TECHNISCHE UNIVERSITÄT
CHEMNITZ

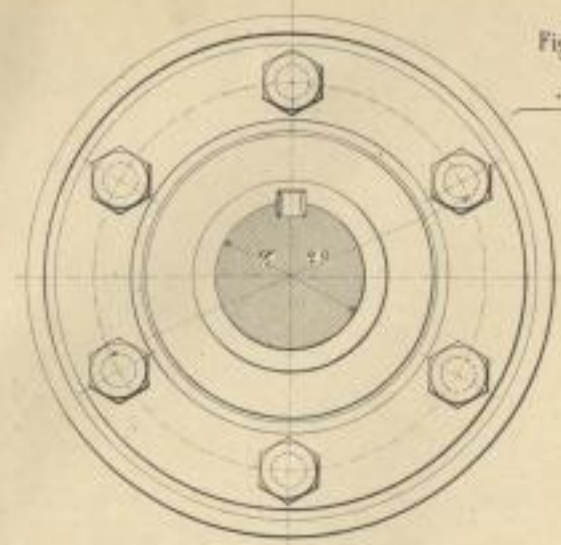

Fig. 132.
2:2

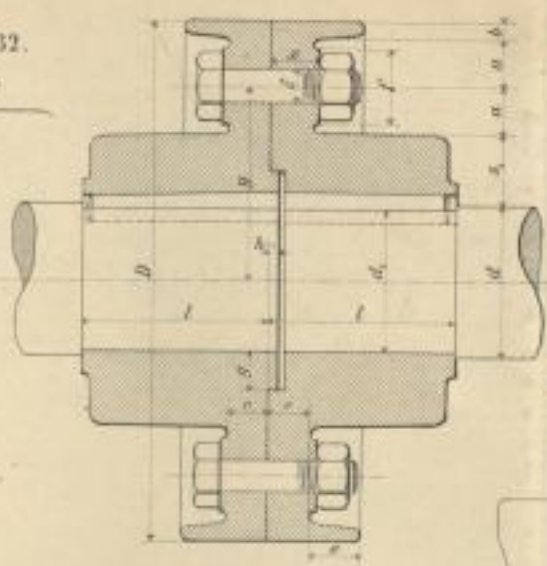

Fig. 133.
1:5

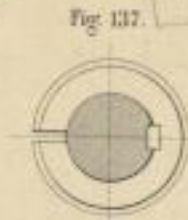

Fig. 137.

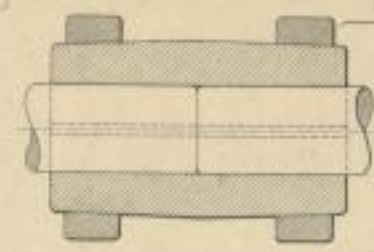

Fig. 136.
1:5



Fig. 138.
2:2

Schnitt a-b.

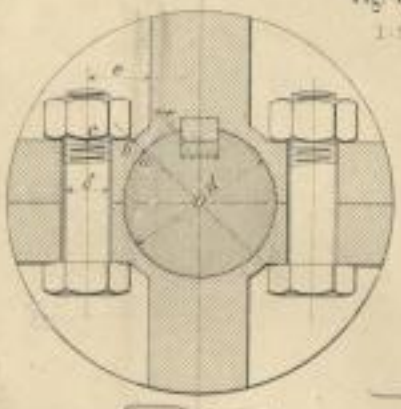
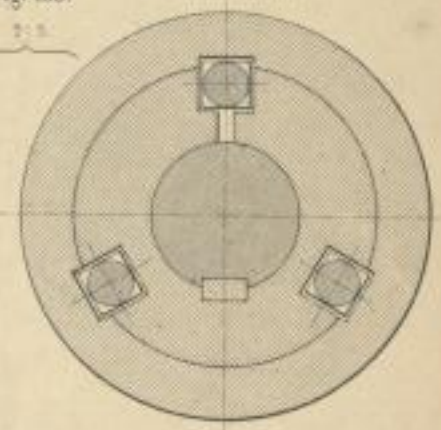

Fig. 134.
1:5

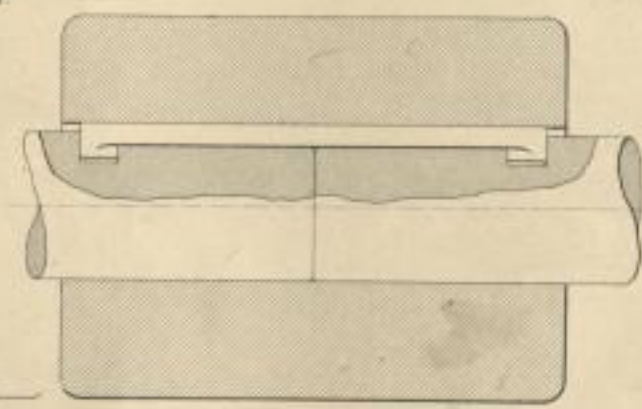

Fig. 131.
1:5

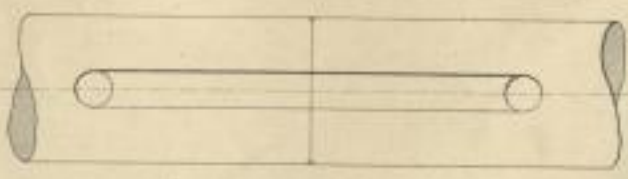

Fig. 135.
2:2

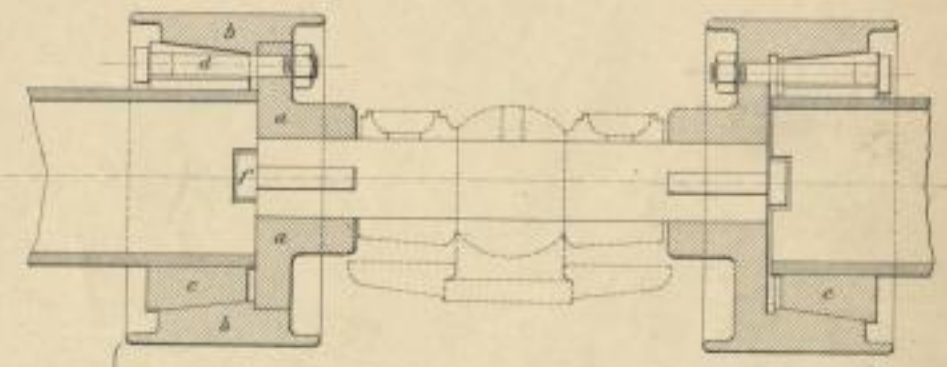
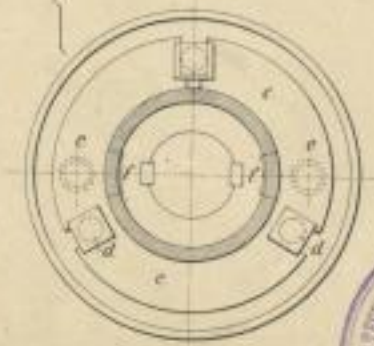

Fig. 139.



131. 132. 133. 134. 135. 136. 137. 138. 139. 140. 141. 142. 143. 144. 145. 146. 147. 148. 149. 150. 151. 152. 153. 154. 155. 156. 157. 158. 159. 160. 161. 162. 163. 164. 165. 166. 167. 168. 169. 170. 171. 172. 173. 174. 175. 176. 177. 178. 179. 180. 181. 182. 183. 184. 185. 186. 187. 188. 189. 190. 191. 192. 193. 194. 195. 196. 197. 198. 199. 200.



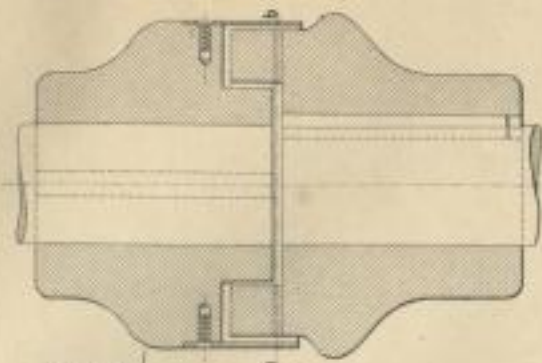

Fig. 140
1:5



Schnitt a b

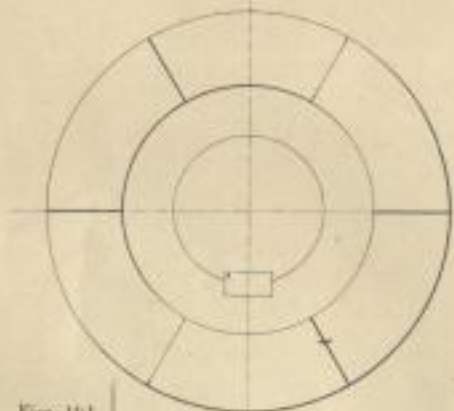
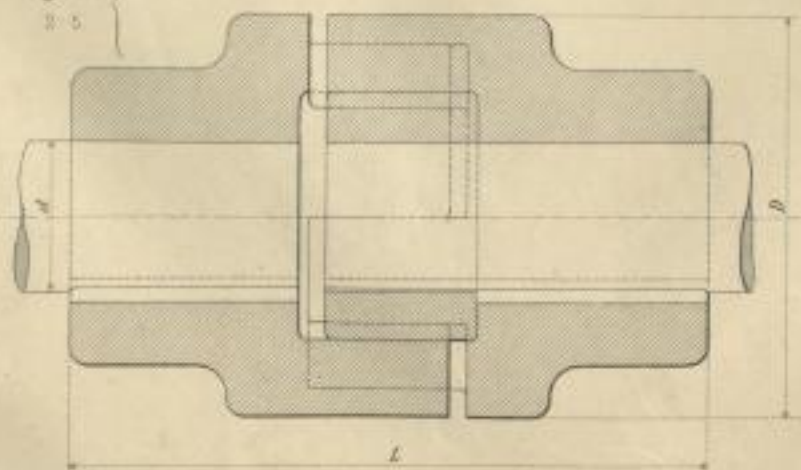

Fig. 141
2:5



10th. Aut. v. F. Wess, Darmstadt.

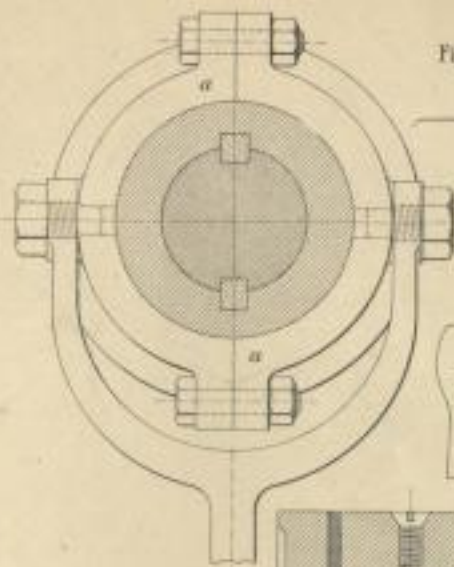

Fig. 143
1:5



Schnitt c d

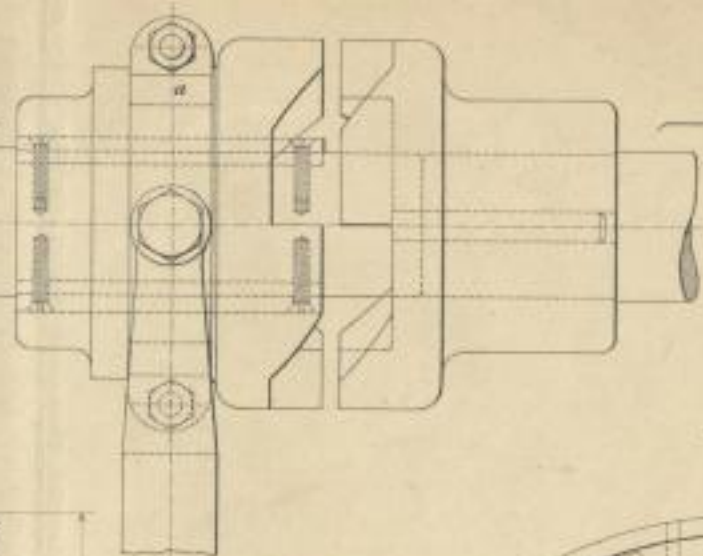
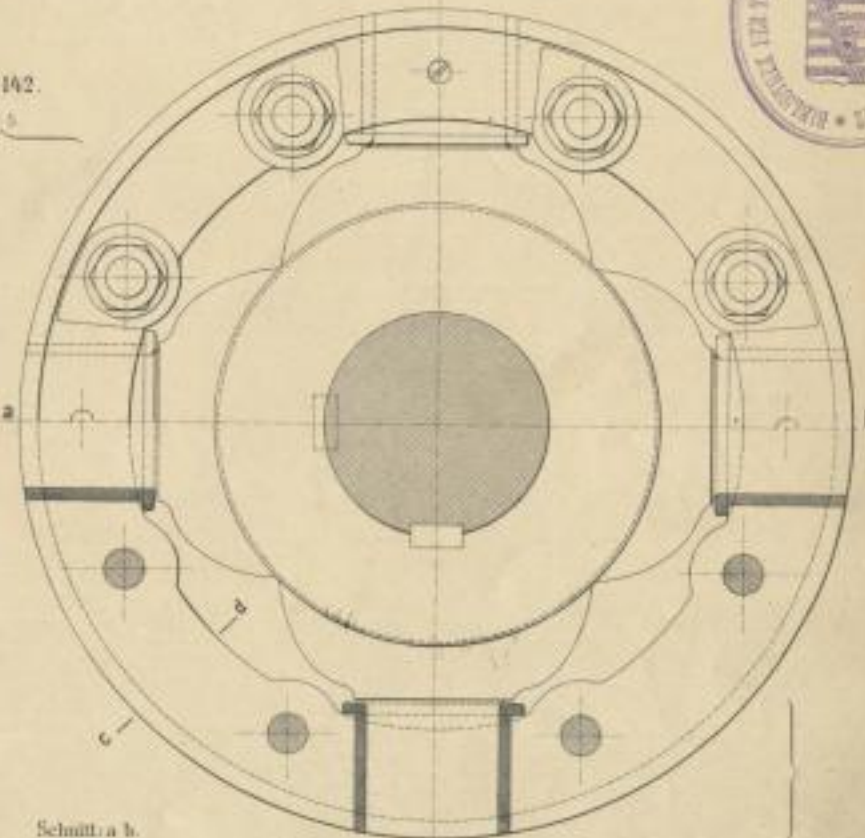
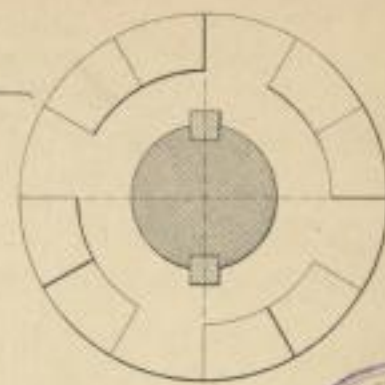
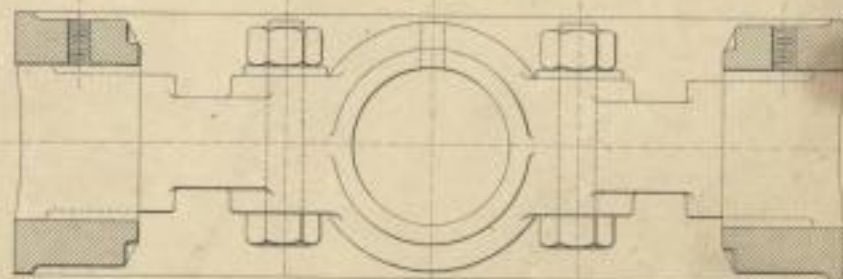
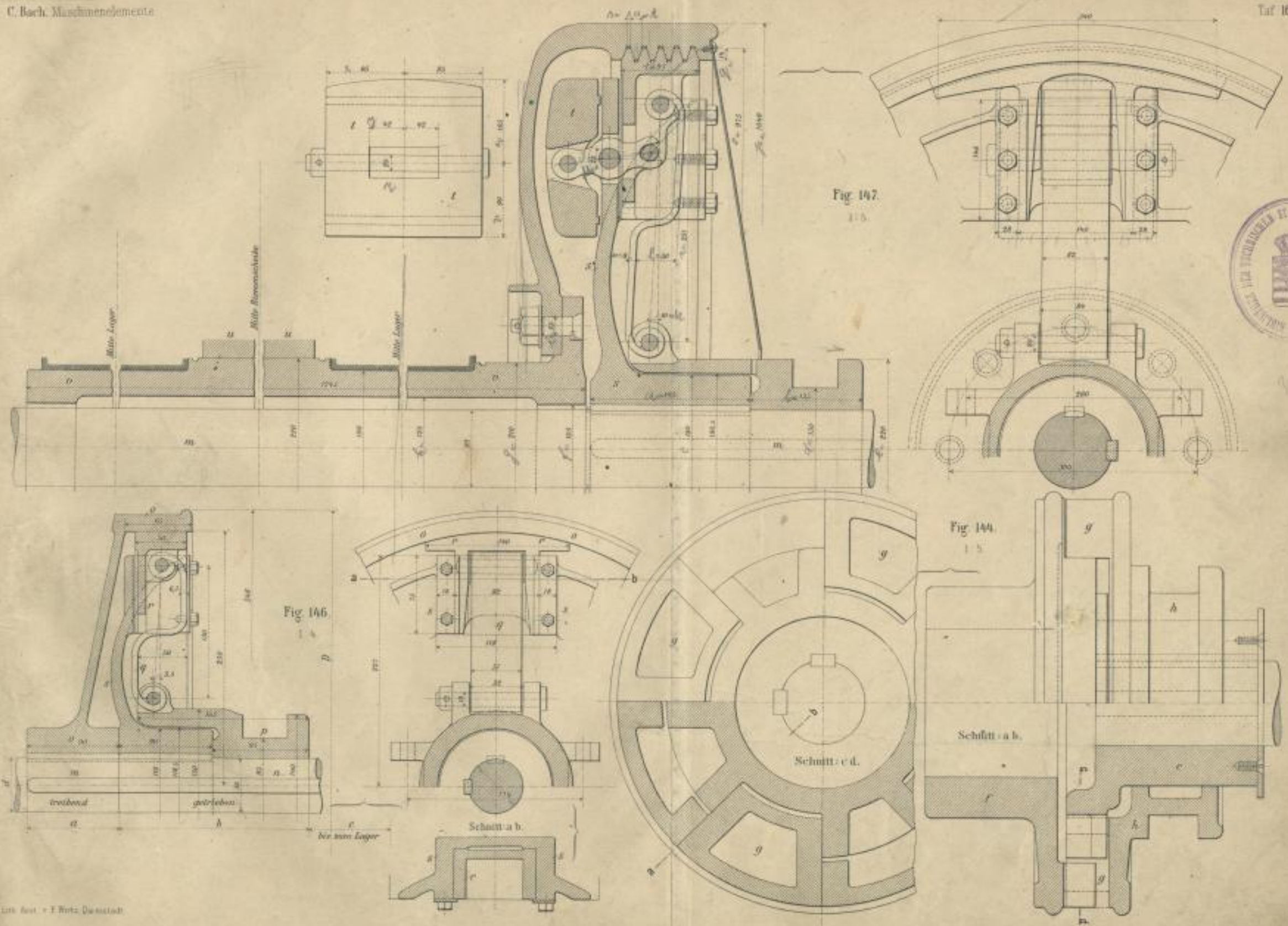

Fig. 142
2:5



Schnitt a b





228. Aufl. • F. Witz, Dresden

Schnitt v w.

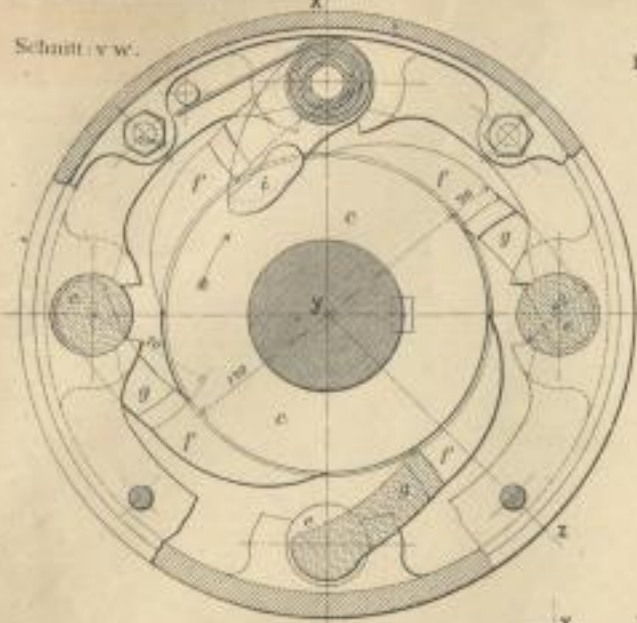
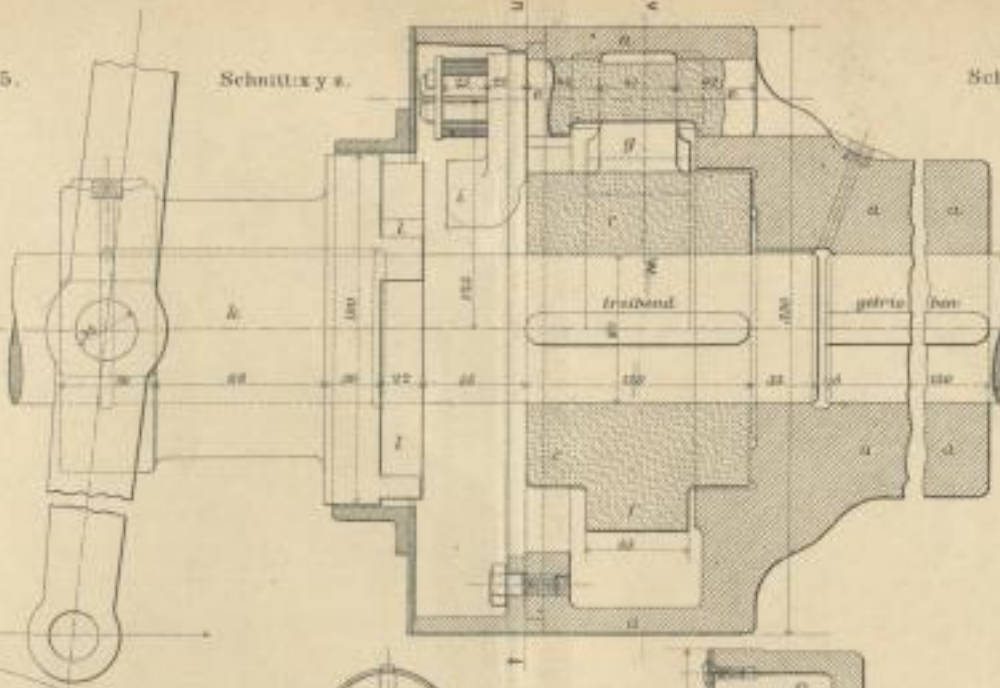

Fig. 165.

Schnitt x y z.



Schnitt t u.

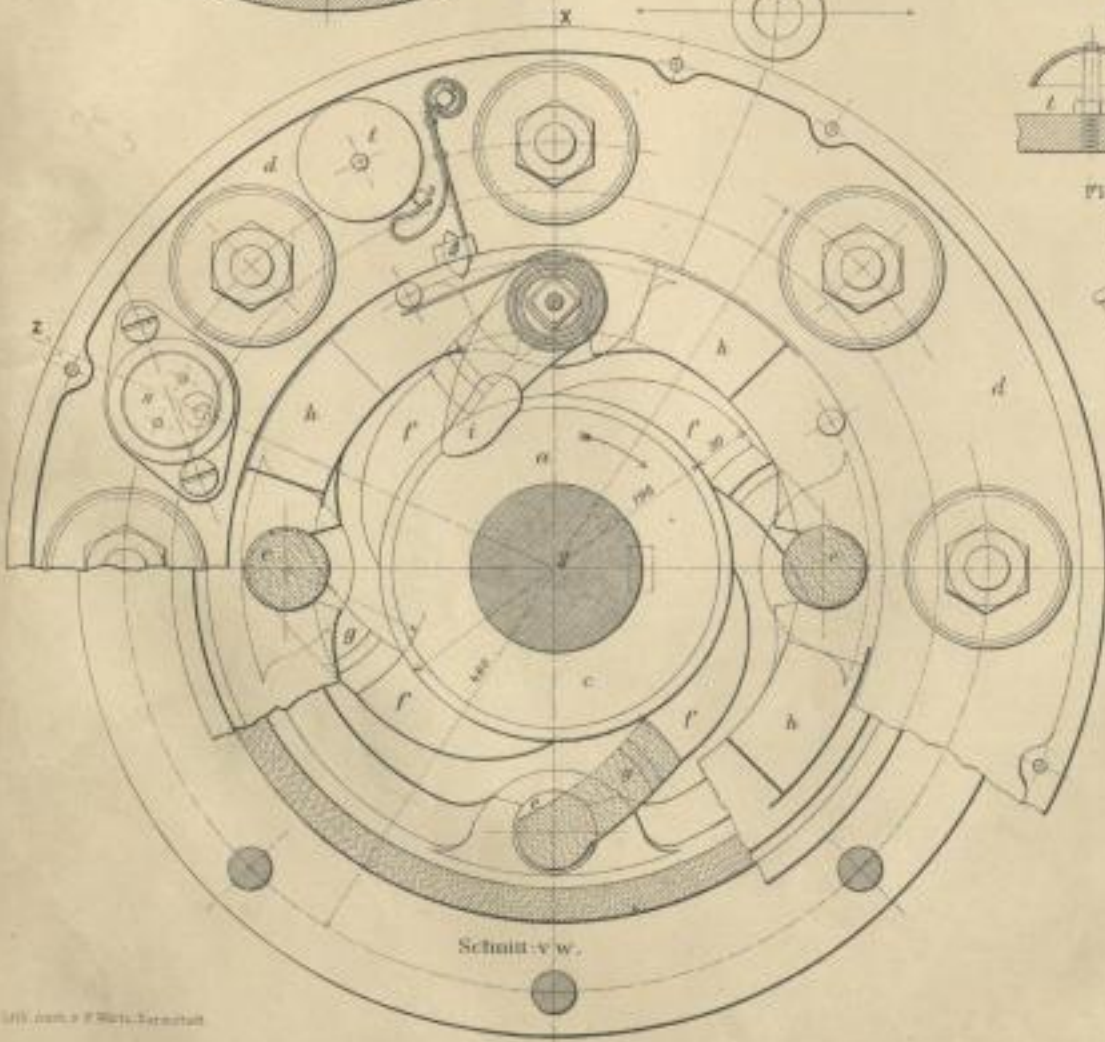
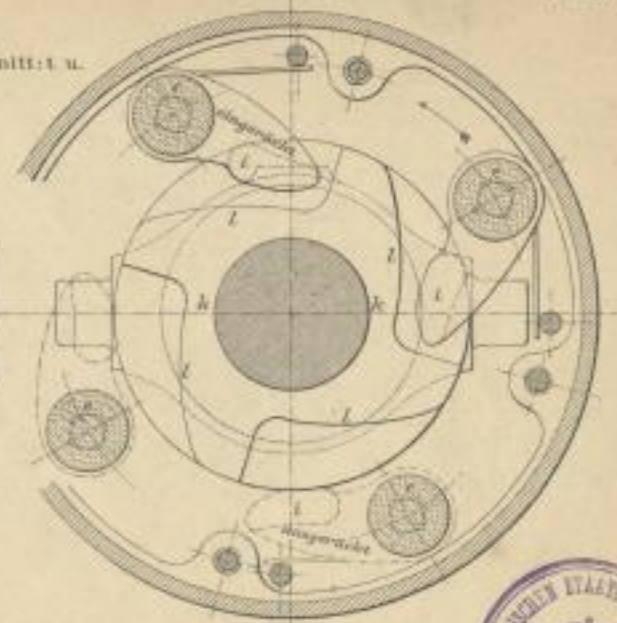
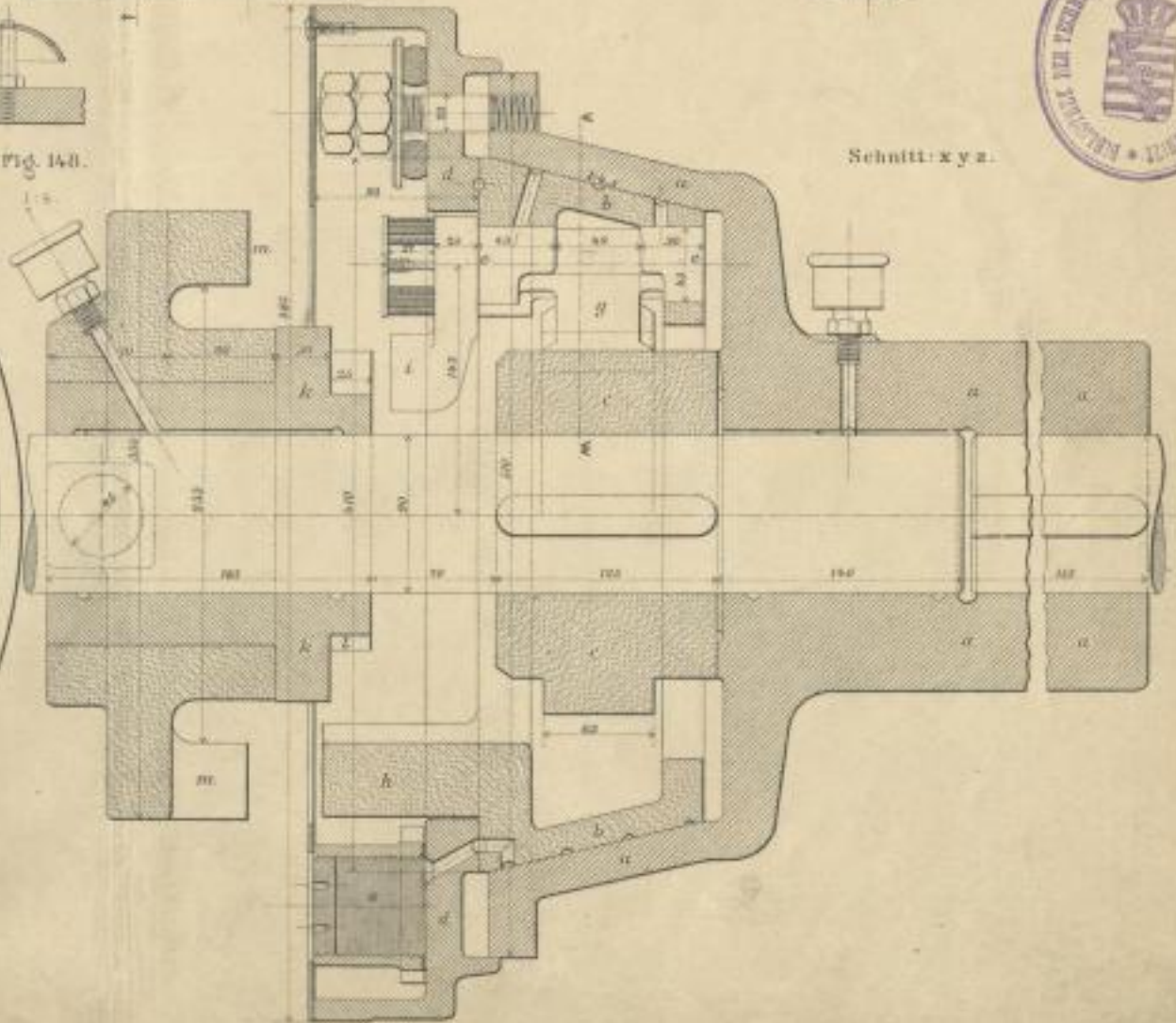
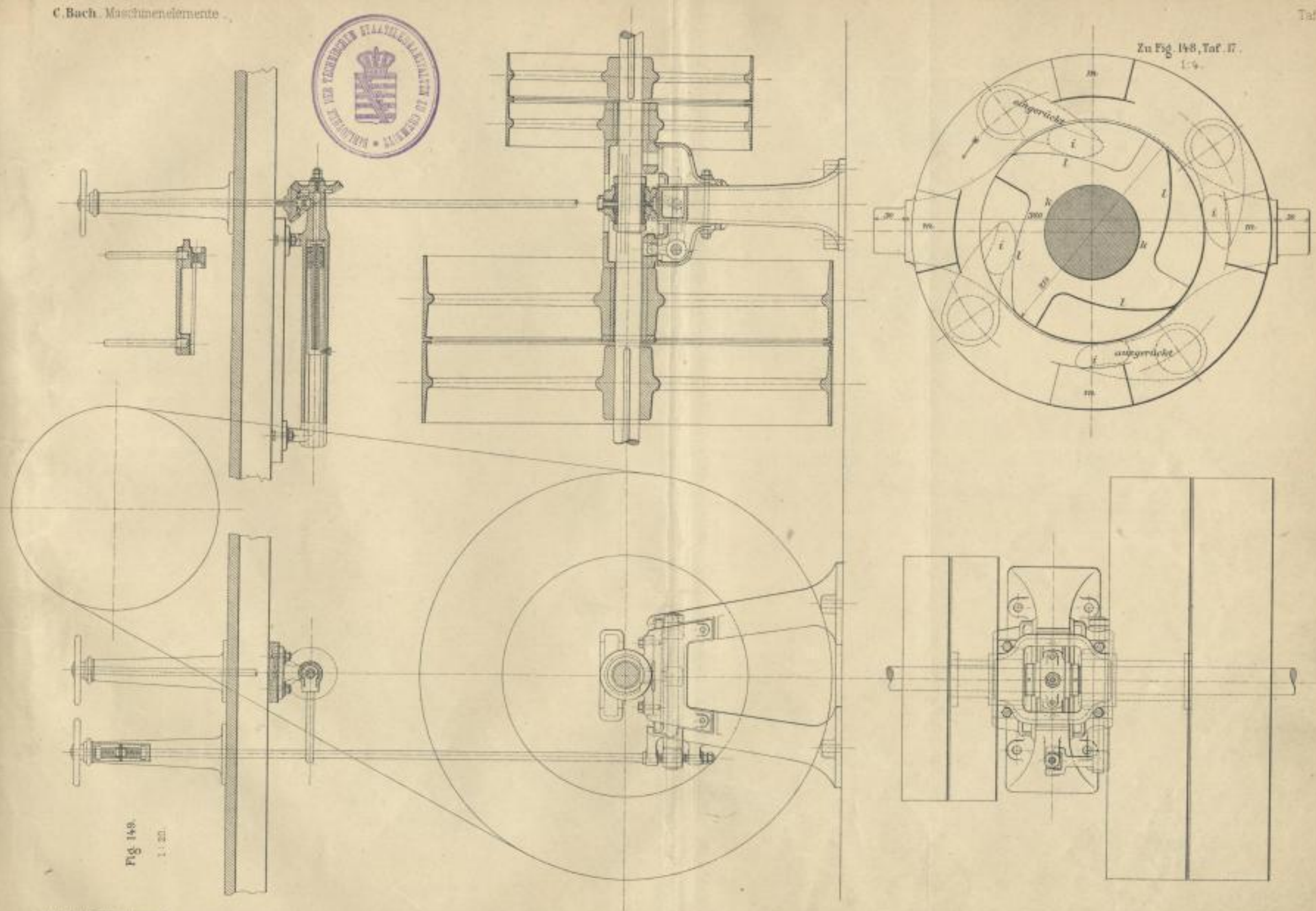

Fig. 148.

Schnitt x y z.





Zu Fig. 148, Taf. 17.
1:4

Fig. 149.
1:20

Lith. Anst. v. F. Witz, Darmstadt



Fig. 150.

1:1

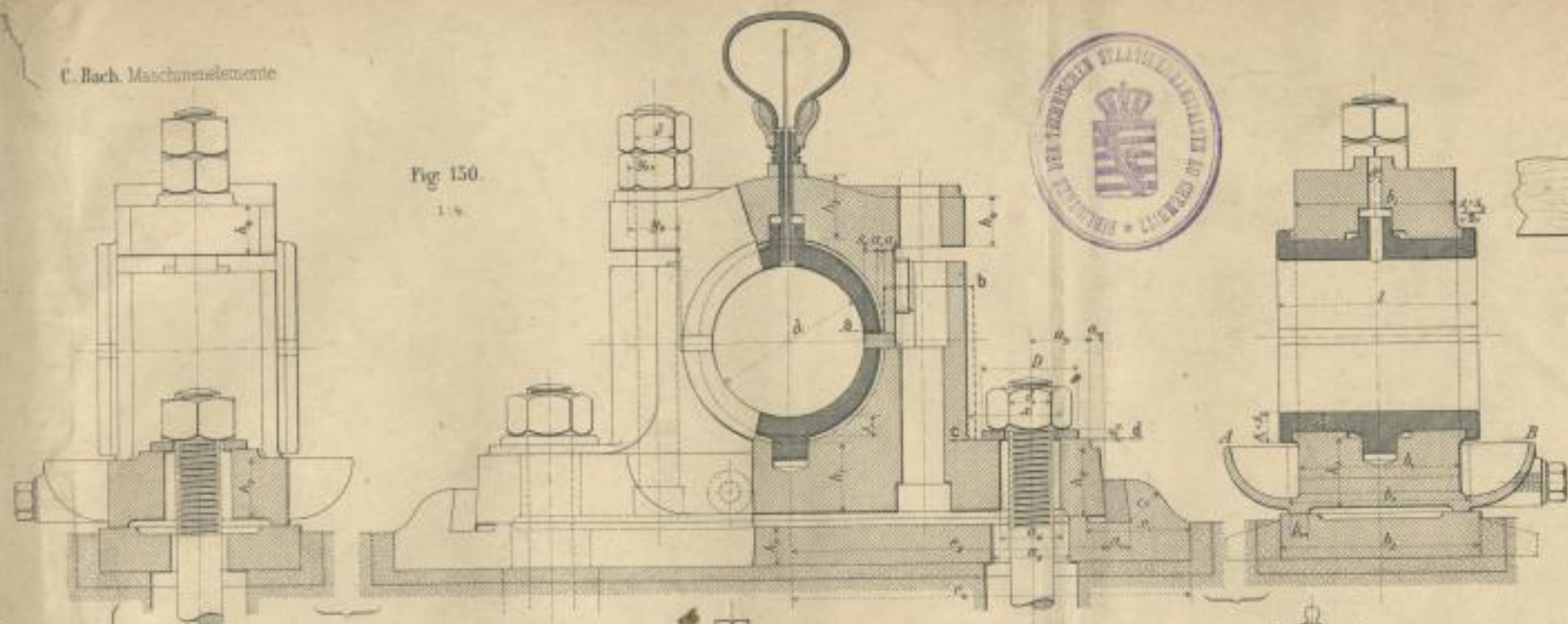

Fig. 151.

1:1

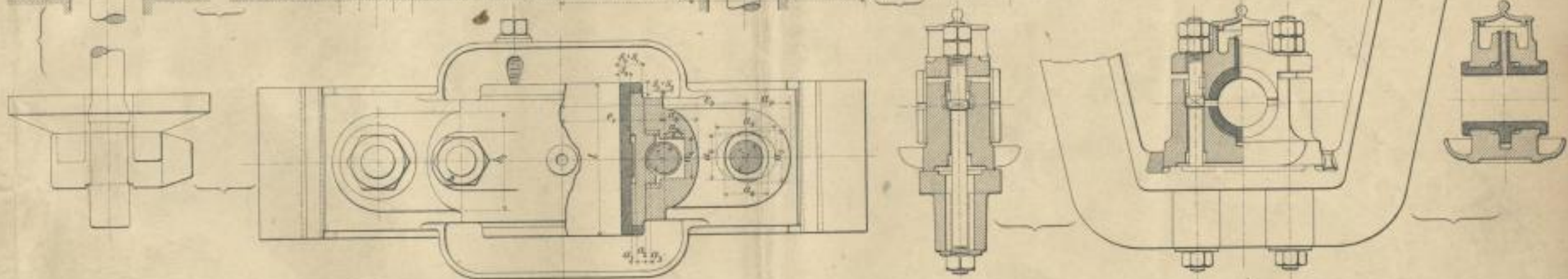
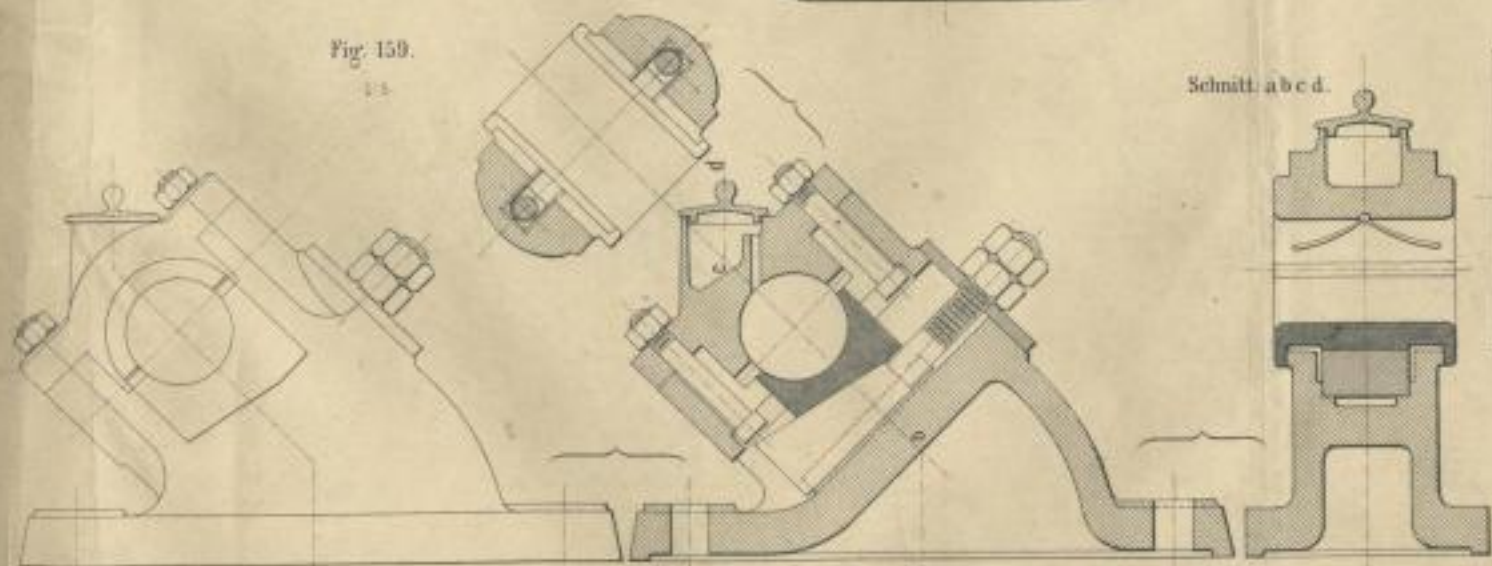
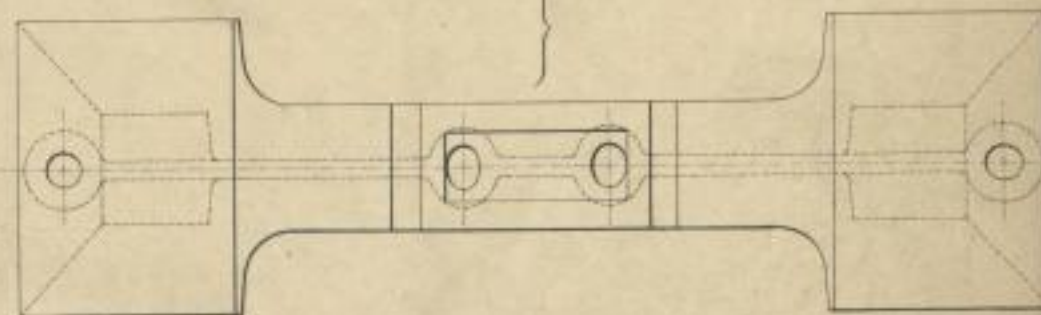

Fig. 152.

1:1



Schnitt a b c d.



10th. Abt. v. F. Wöhr, Eisenstadt.

Fig. 152.
1-5.

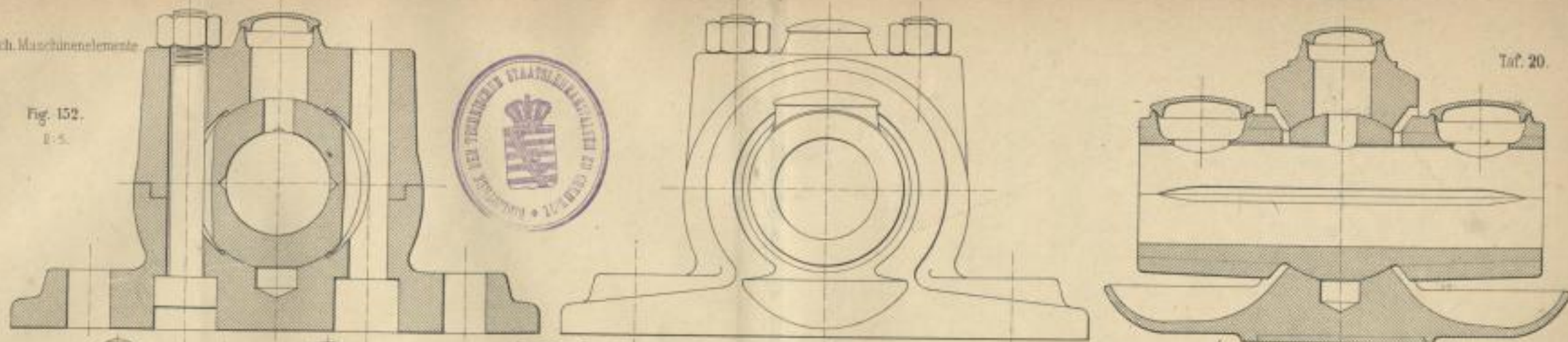

Fig. 153.
1-4.

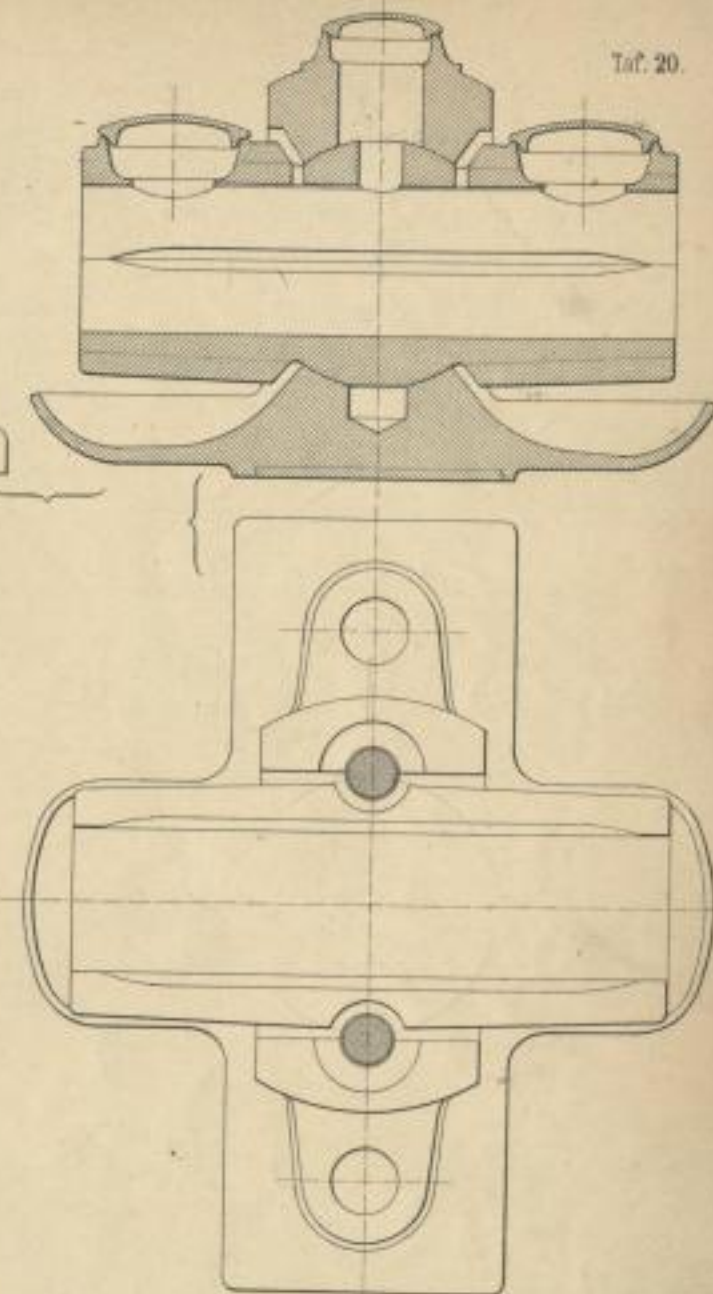
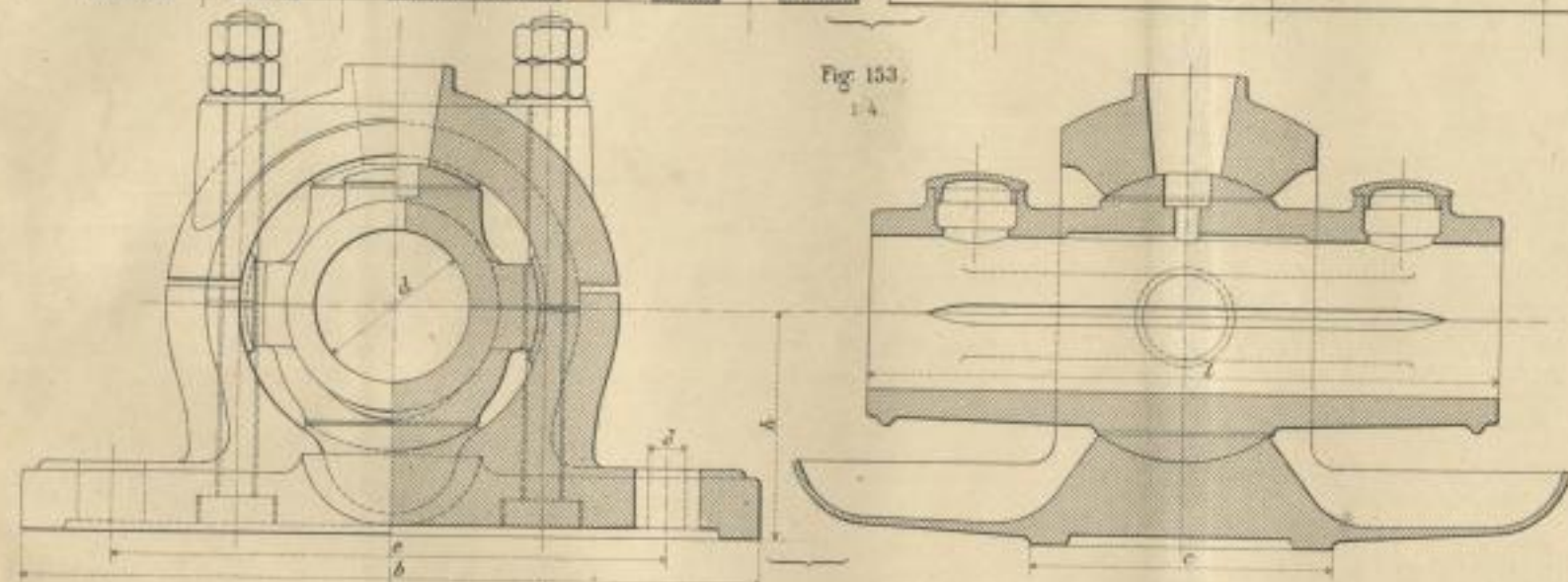
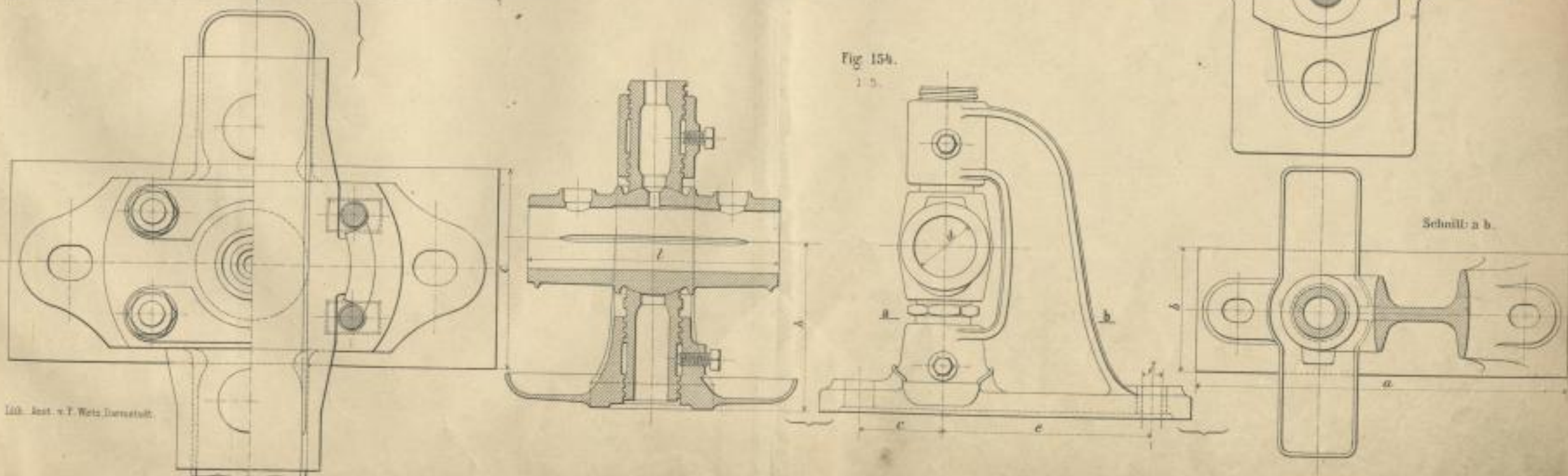

Fig. 154.
1-5.



100. Inst. v. F. Wetz, Darmstadt.



SLUB

Wir führen Wissen.

<http://digital.slub-dresden.de/id446692875/44>



TECHNISCHE UNIVERSITÄT
CHEMNITZ



Fig. 155.

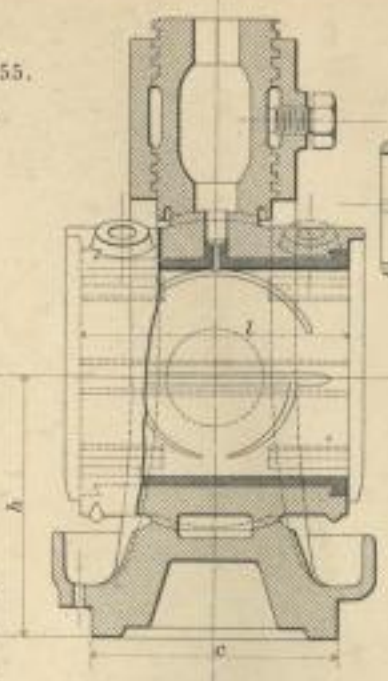
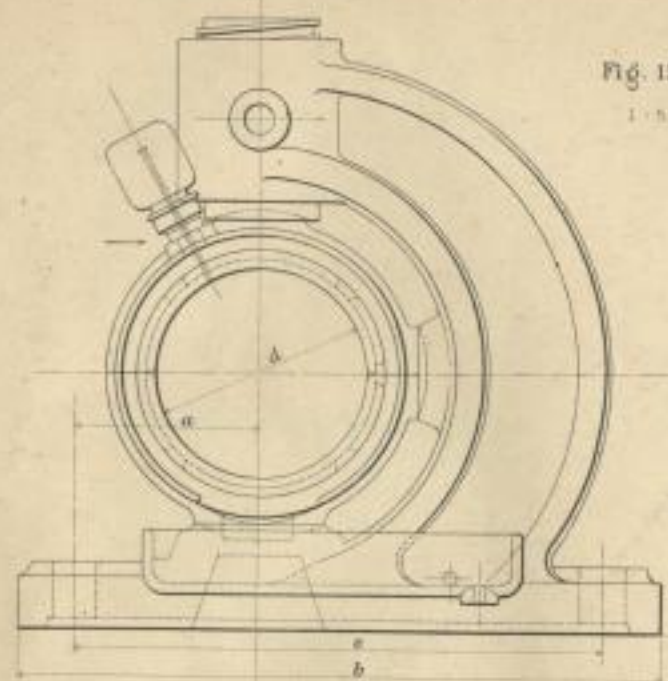

Fig. 156.

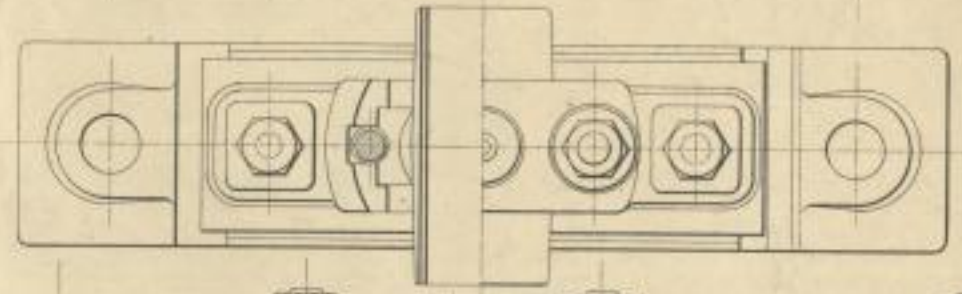
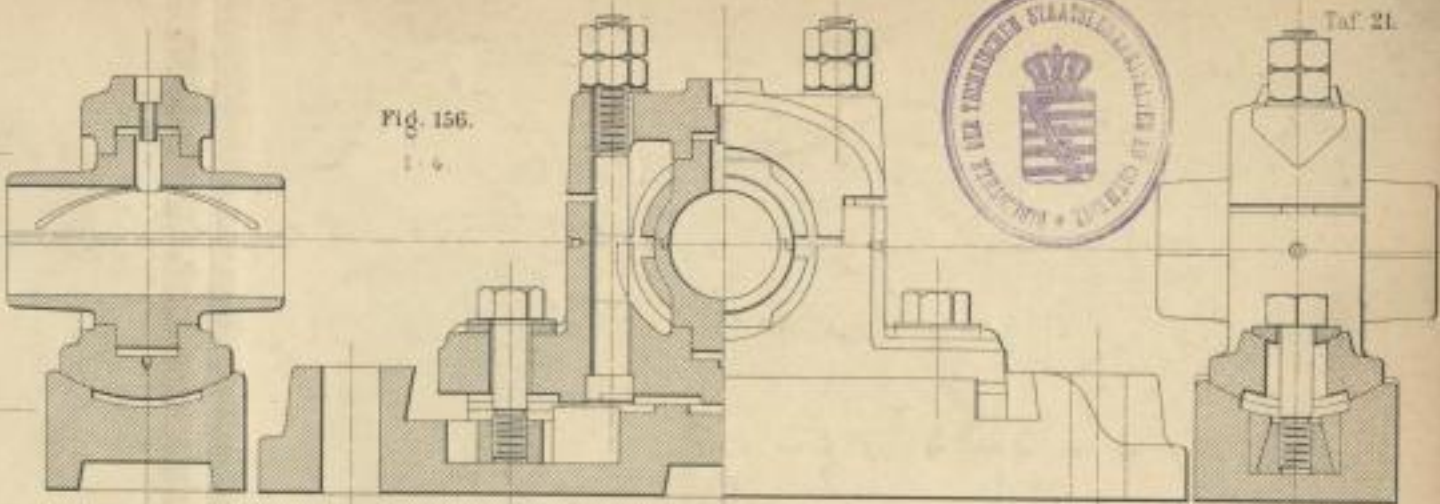

Fig. 160.

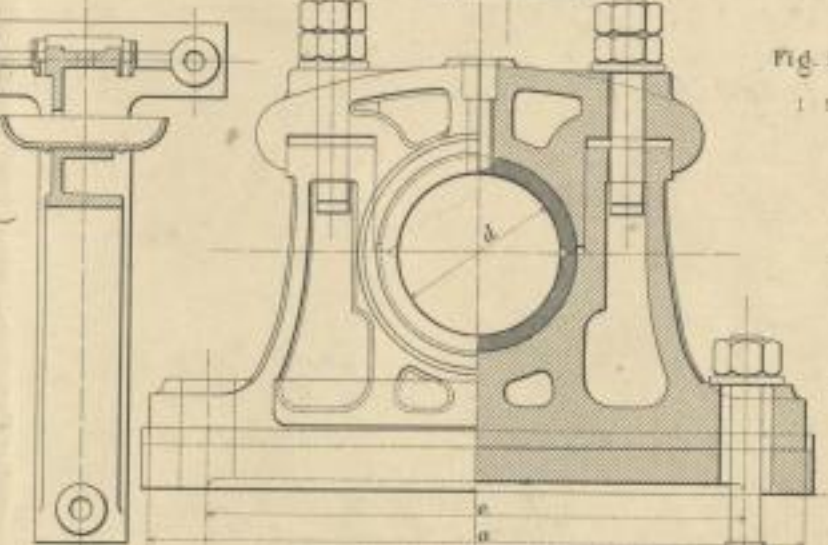
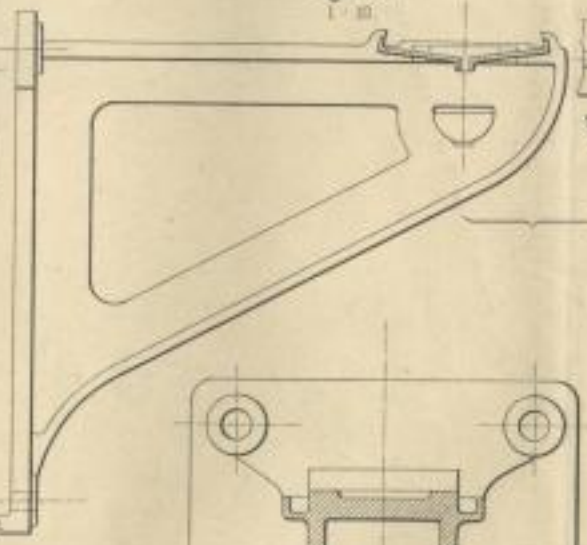
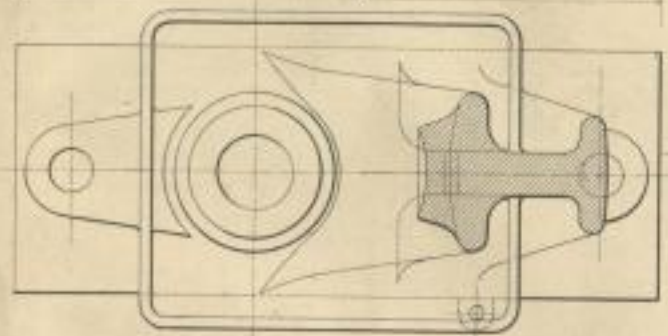

Fig. 161.

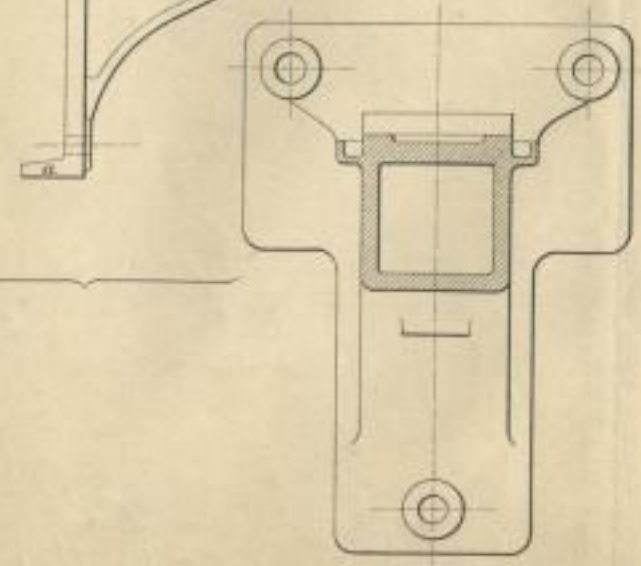
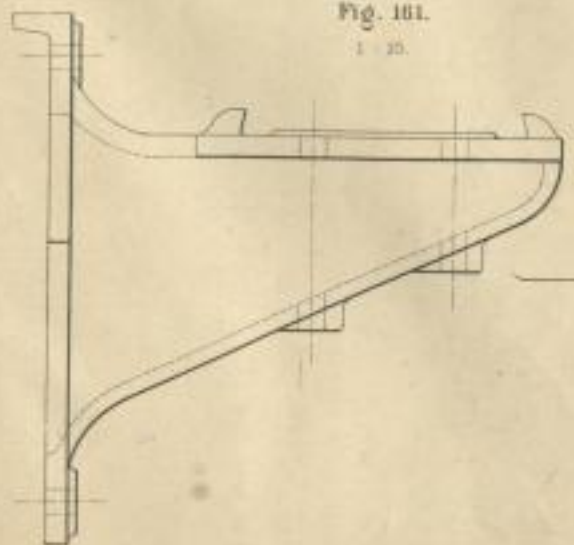

Fig. 157.



Abb. 155 u. 156. Schmitt

Fig. 158.

1:5

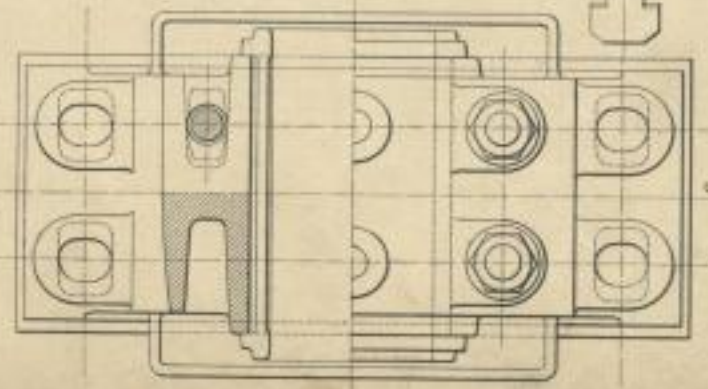
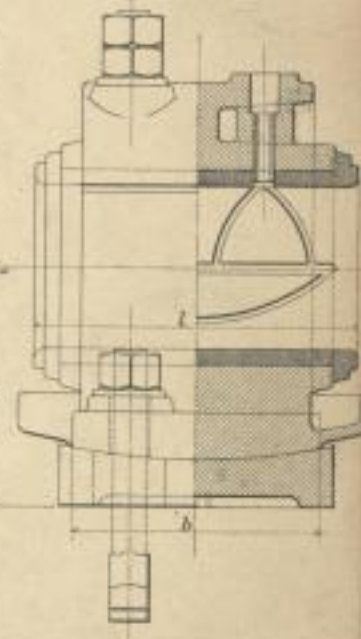
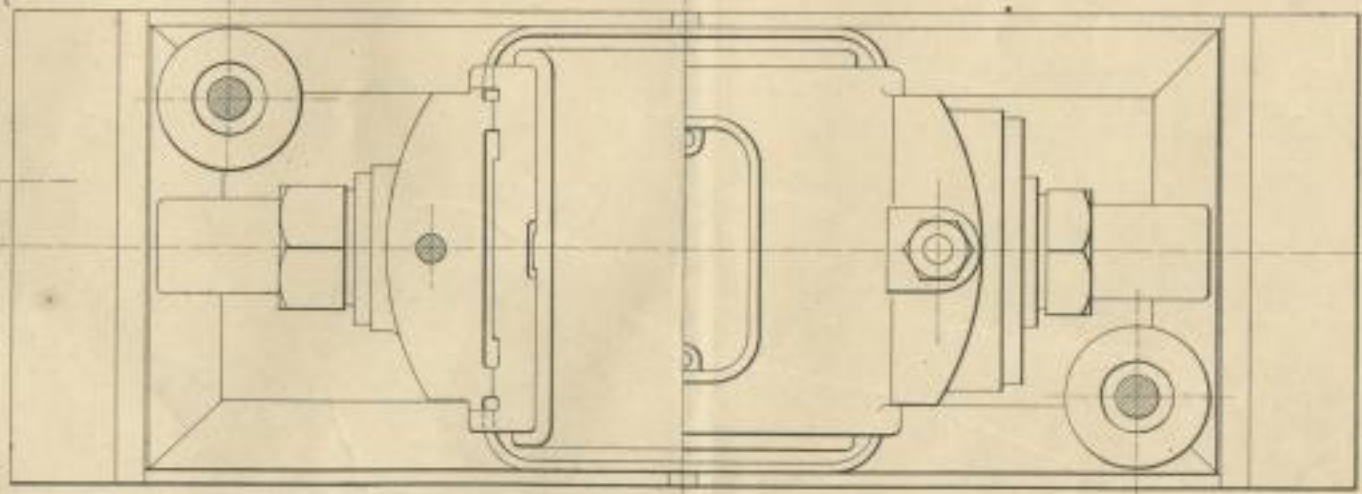
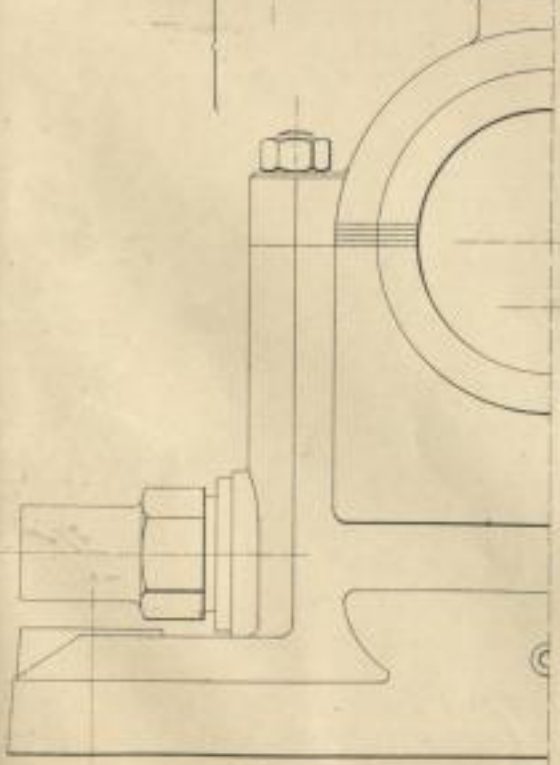
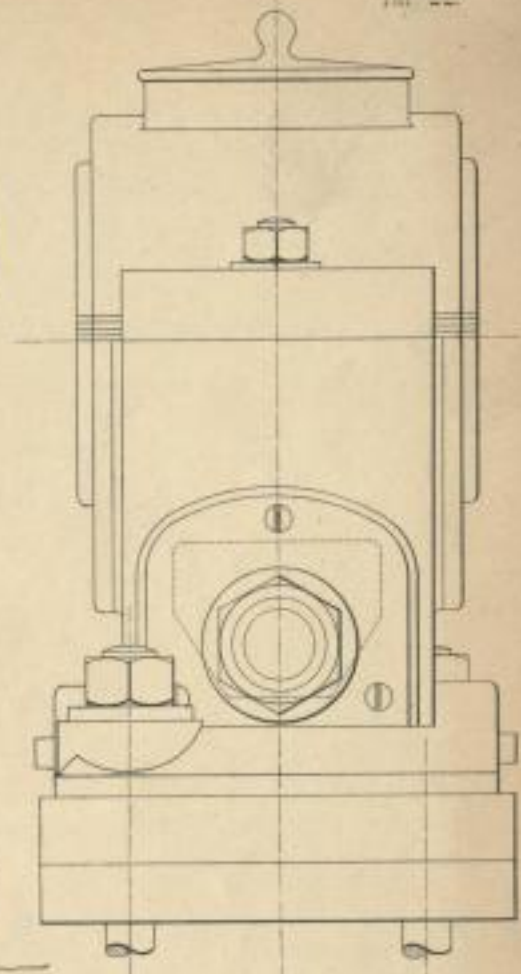
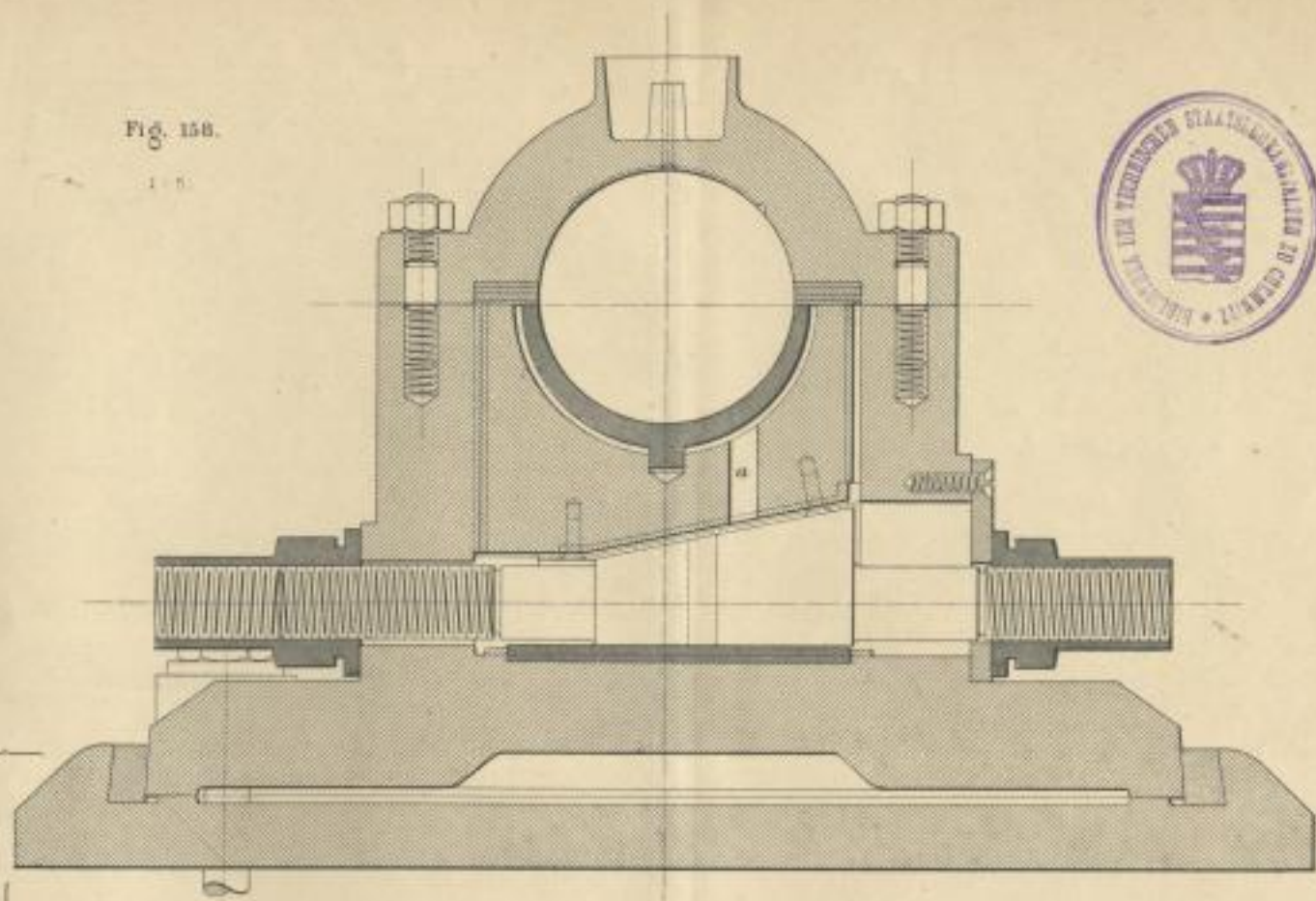
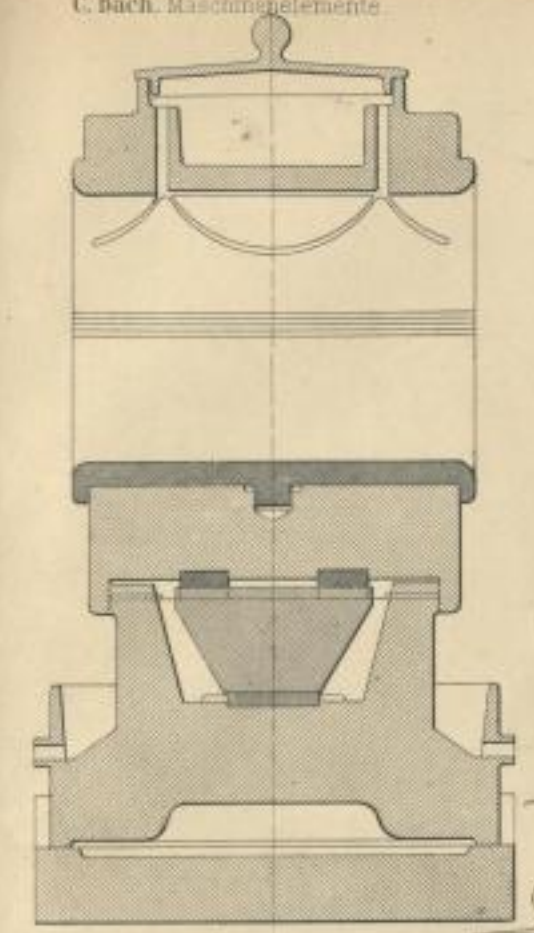
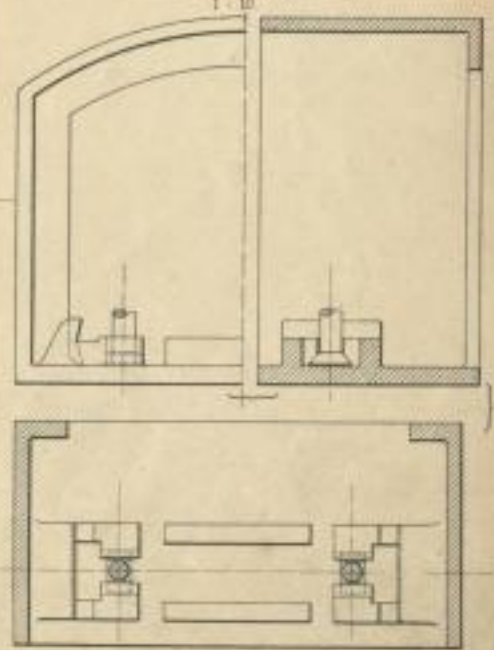

Fig. 168.

1:10



120. Axel + F. Wirtz, Darmstadt

Fig. 162

1:1

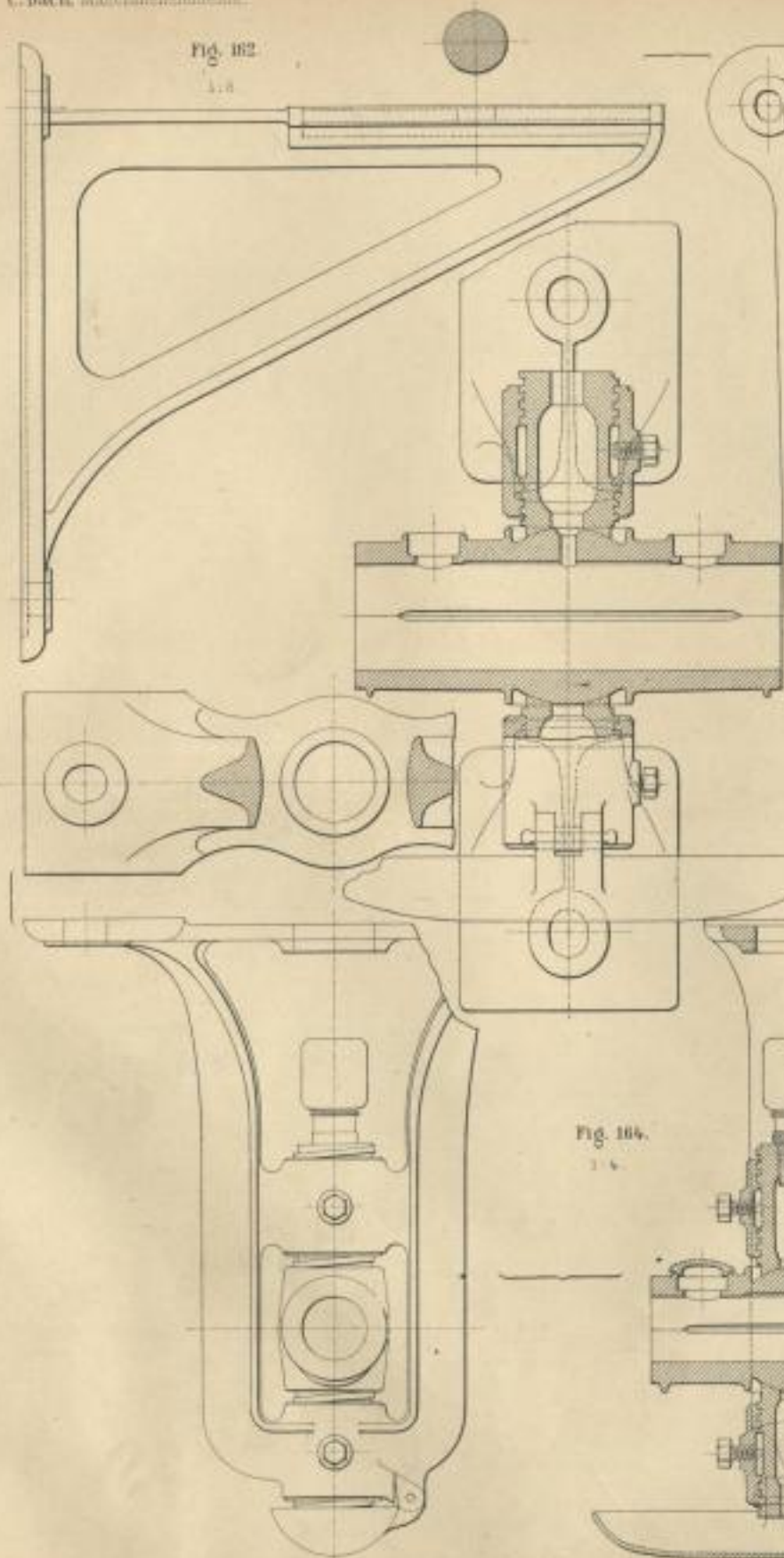

Fig. 163

1:1

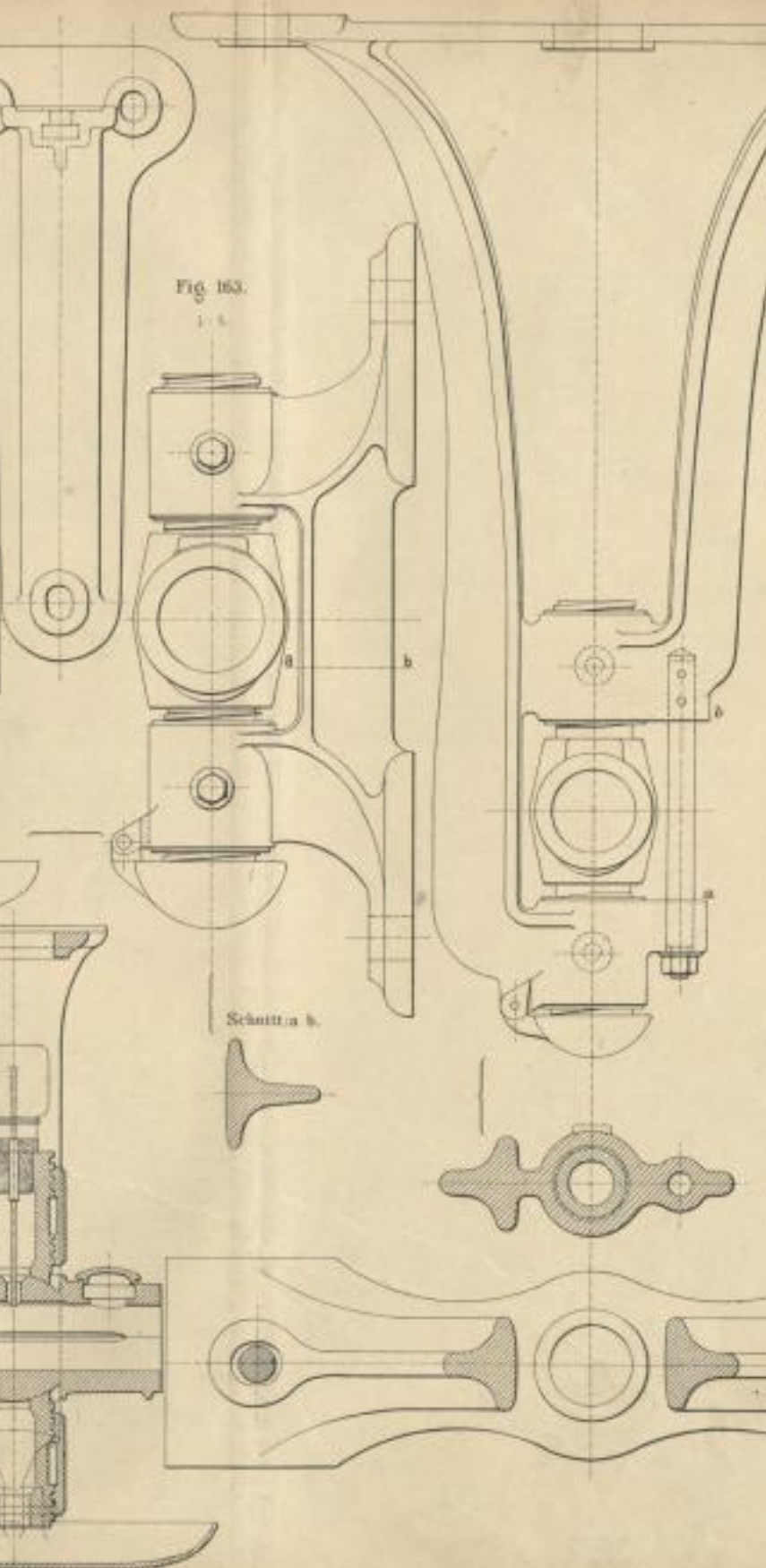

Fig. 165

1:1

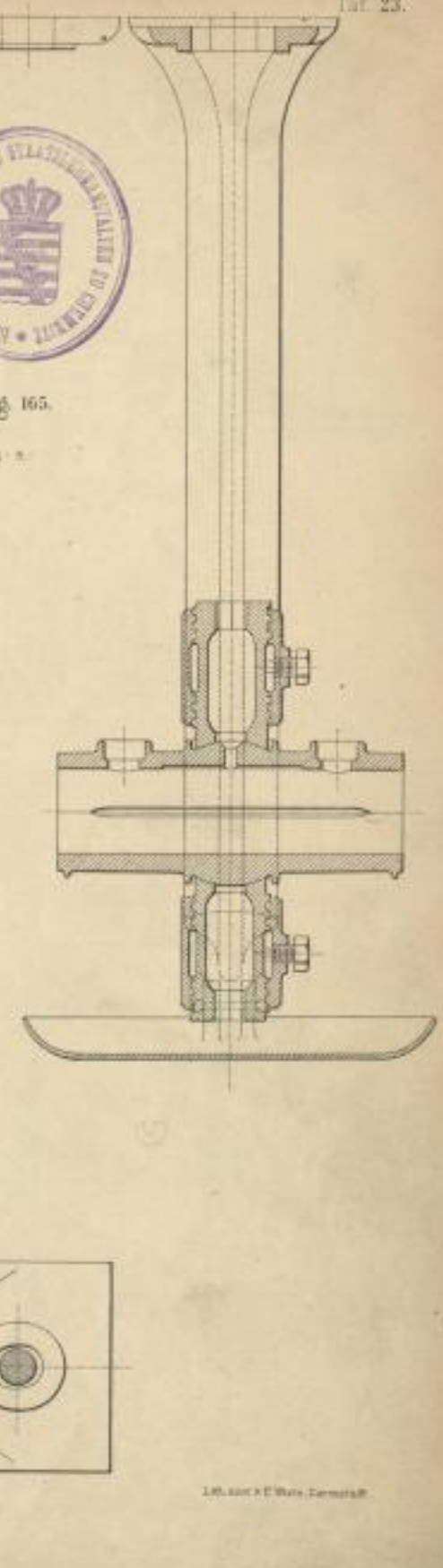
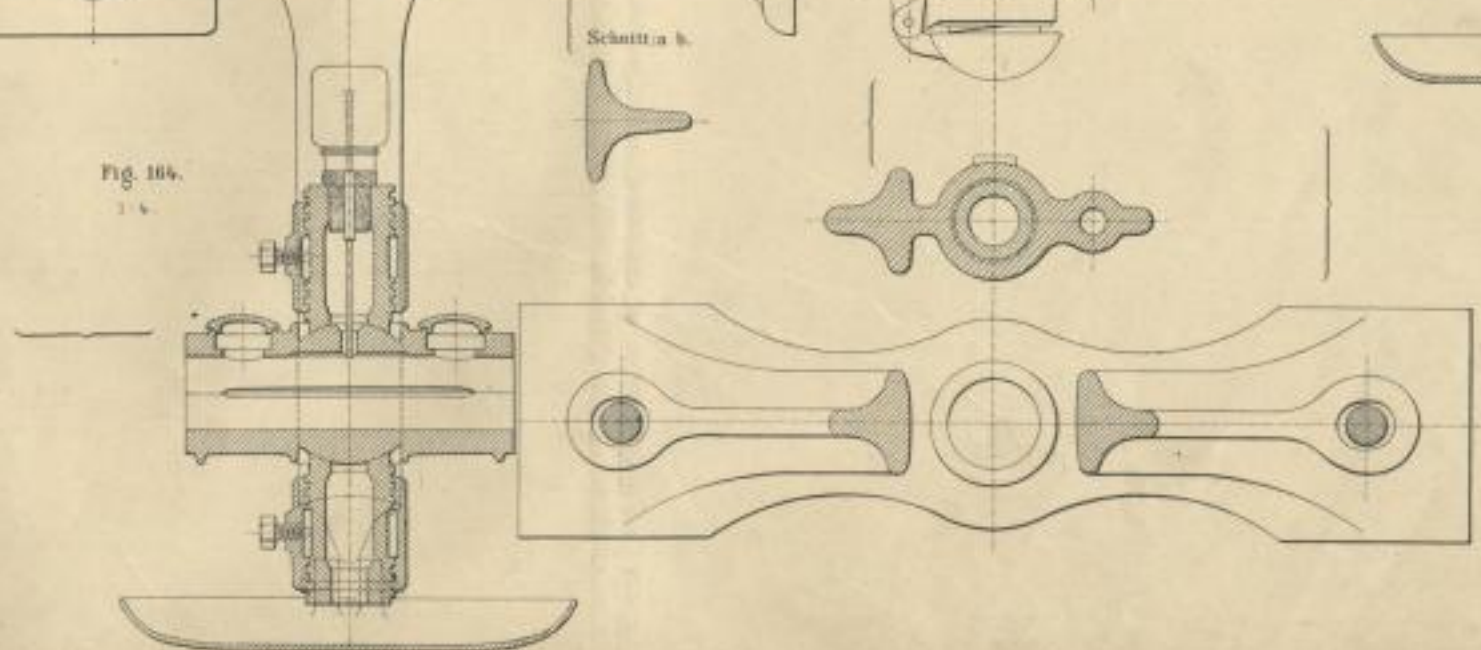

Fig. 164

1:1



L. W. Göttsch & E. W. W. Ziemann



Fig. 166.

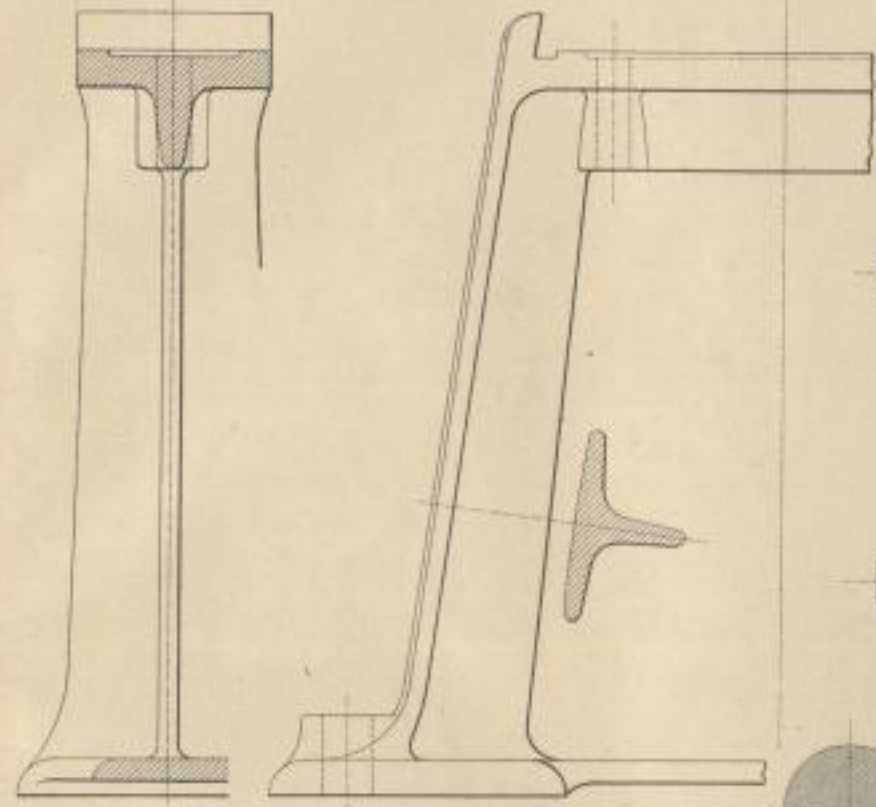

Fig. 172.

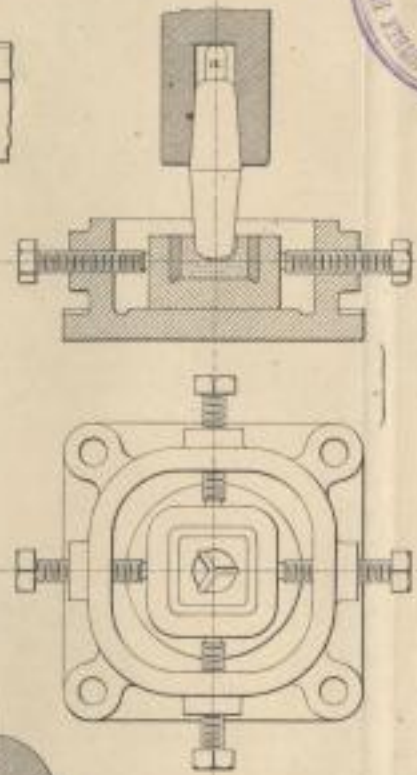

Fig. 173.

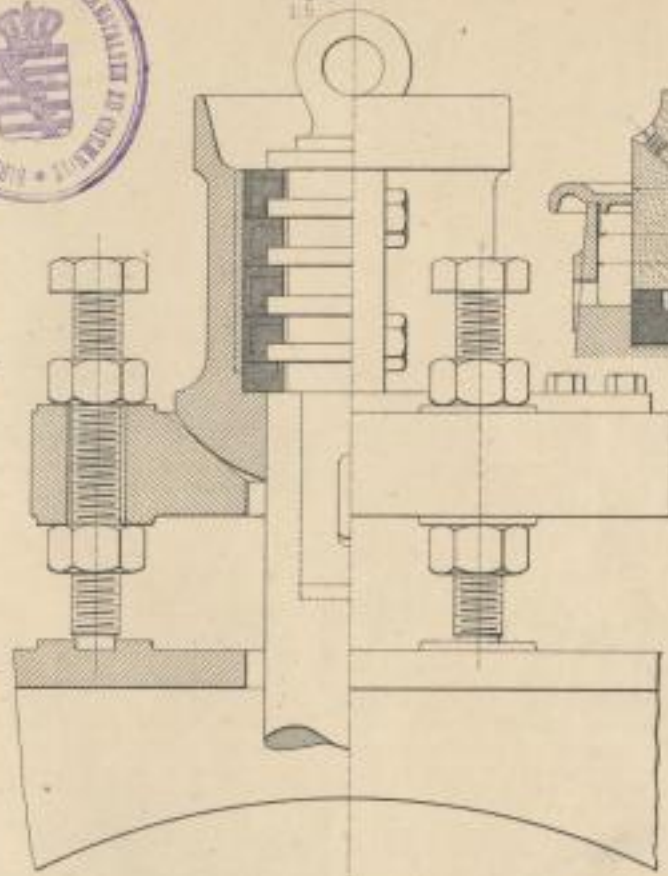

Fig. 174.

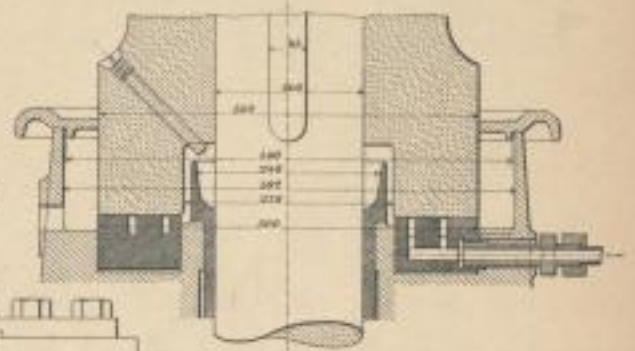
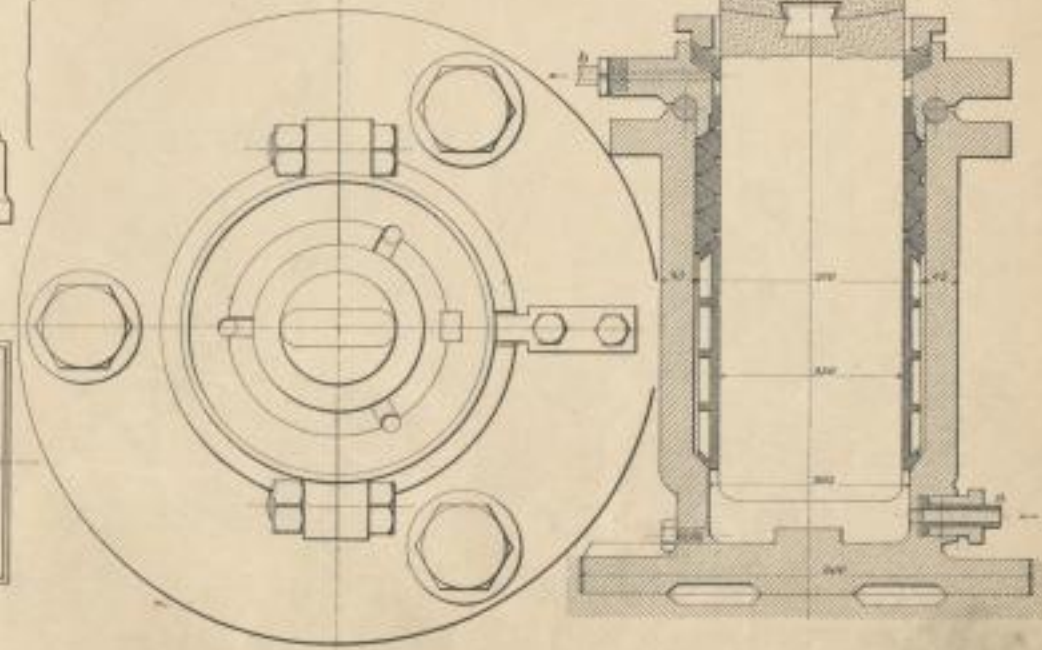
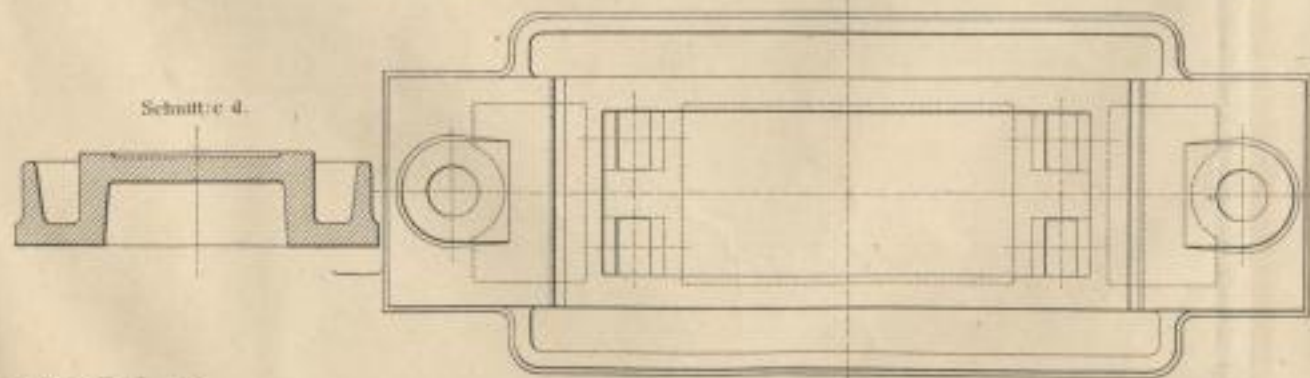
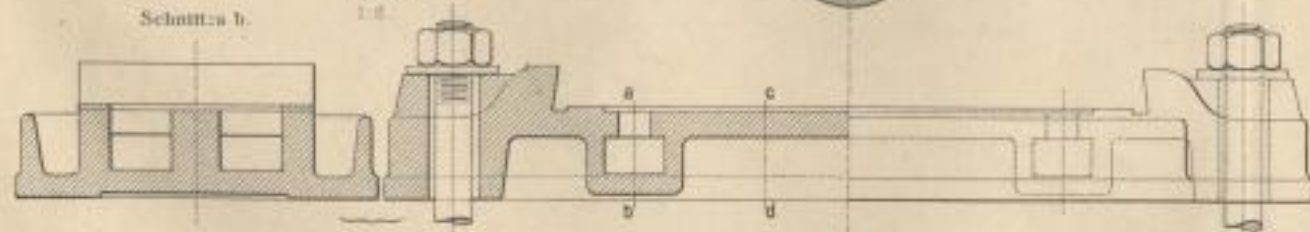

Fig. 167.



125. Anst. v. T. Wittenberg.





Fig. 170.
1-5

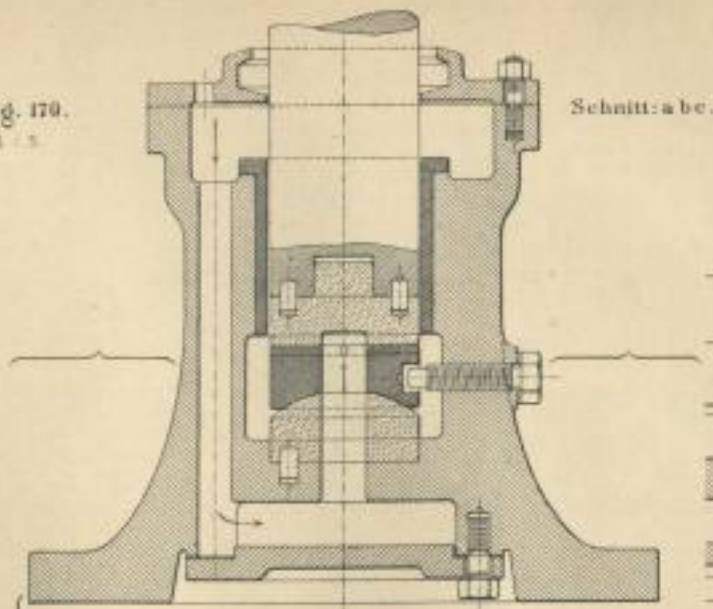

Schnitt: d b.

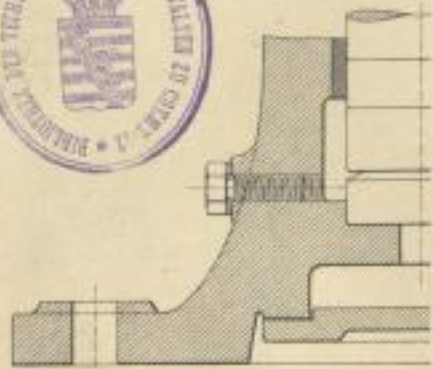
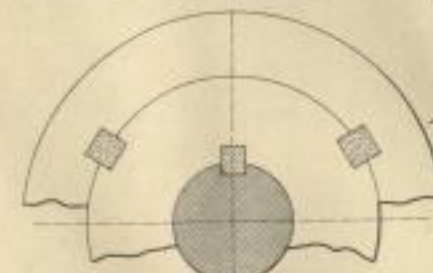
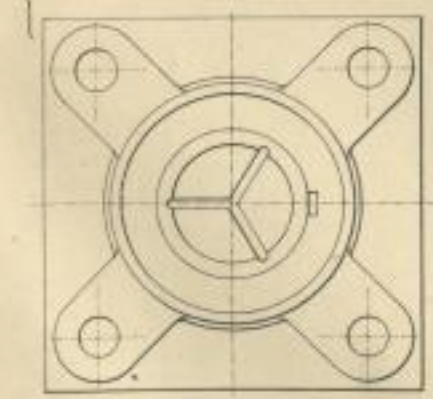
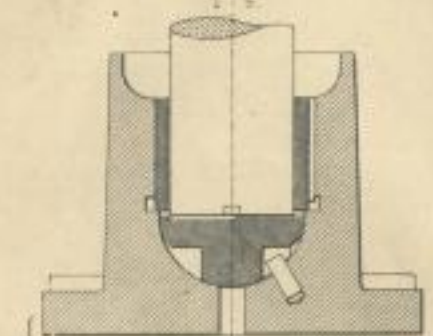

Fig. 169.
1-5



Lab. Aut. v. F. Wirtz, Darmstadt

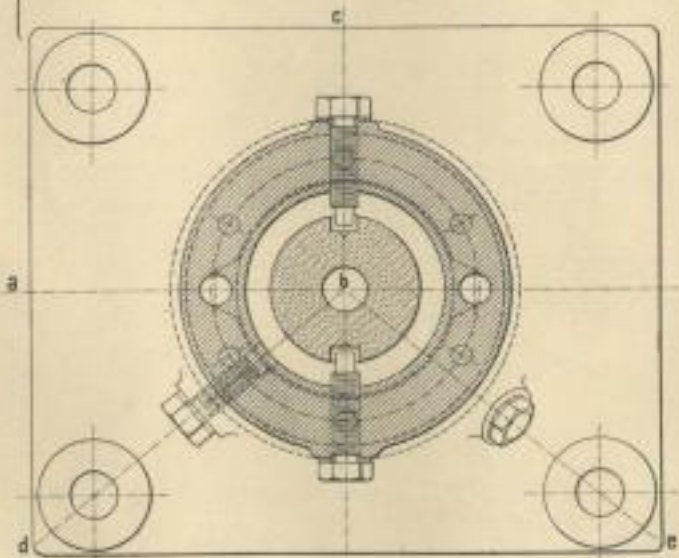
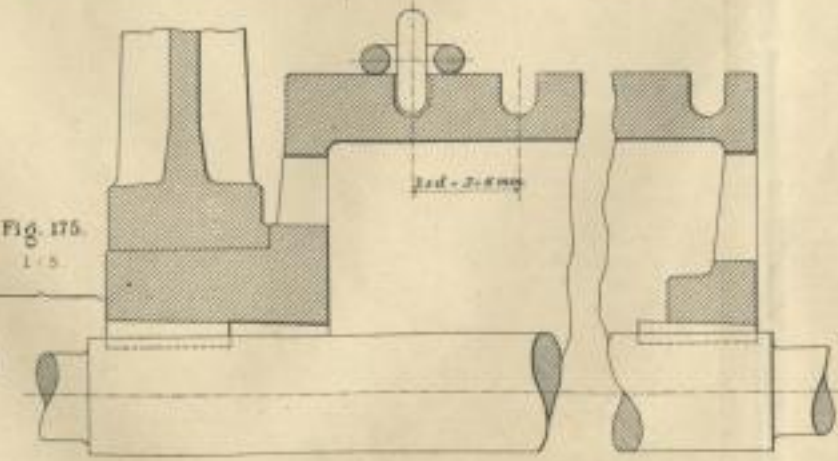

Fig. 175.
1-5



Schnitt: a b e.

Schnitt: b e.

Fig. 178.
1-5

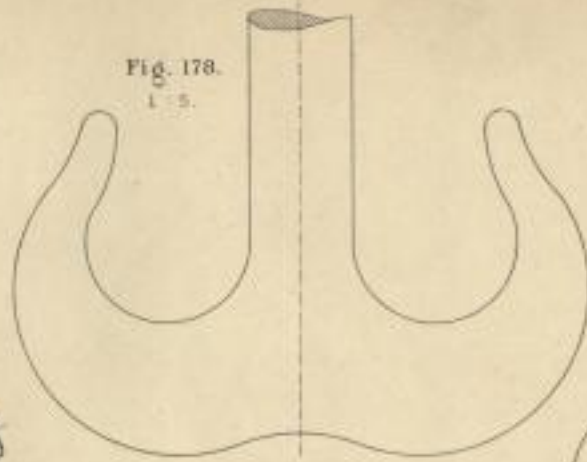

Fig. 179.
1-5

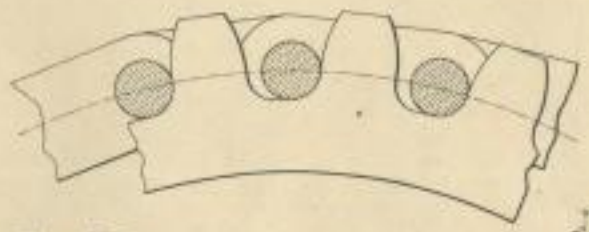

Fig. 176.
1-5

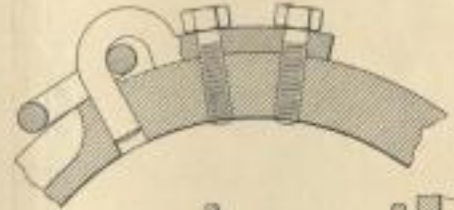

Fig. 174.
1-5

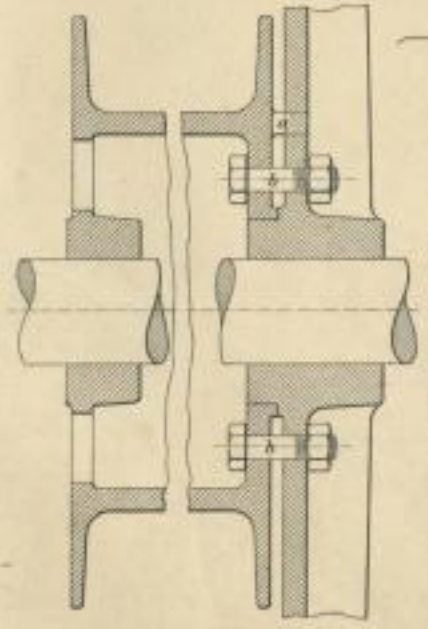
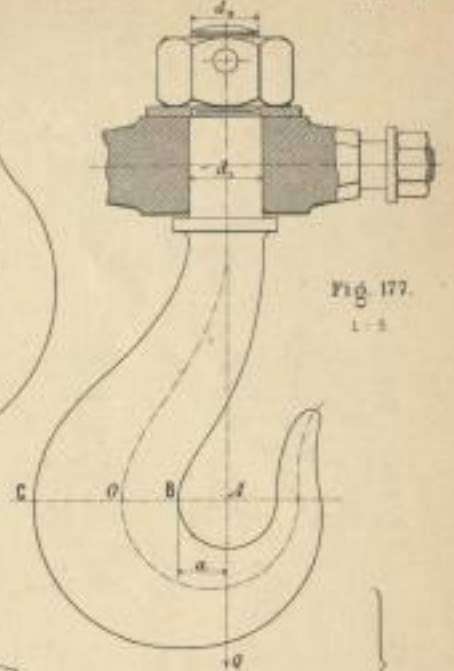
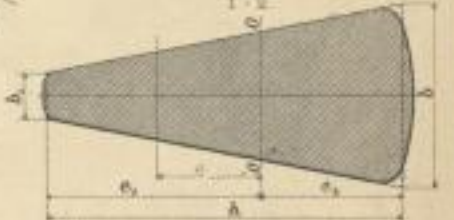

Fig. 177.
1-5



Schnitt: C B.





SLUB

Wir führen Wissen.

<http://digital.slub-dresden.de/id446692875/54>



TECHNISCHE UNIVERSITÄT
CHEMNITZ

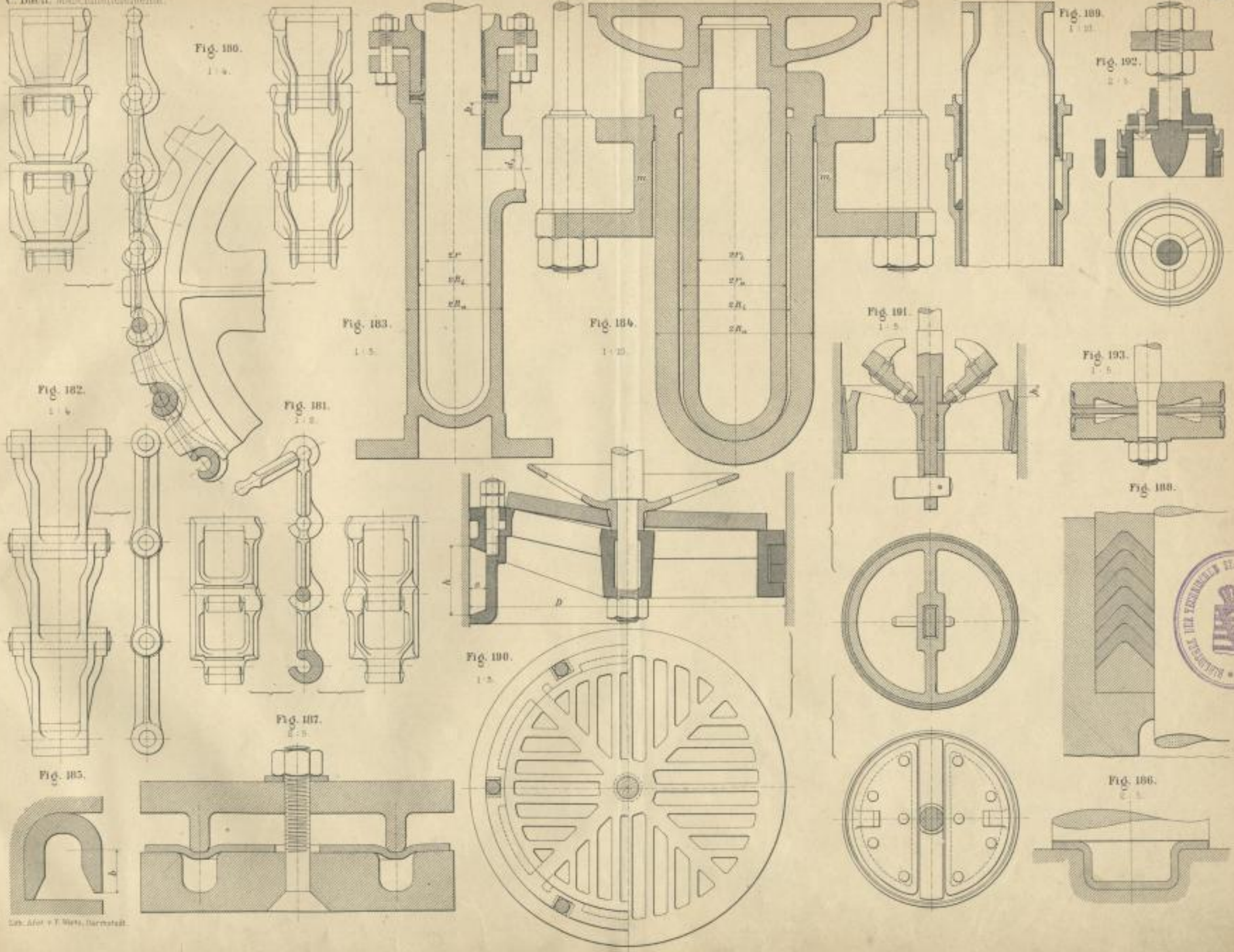

Verlag v. T. Metz, Darmstadt.



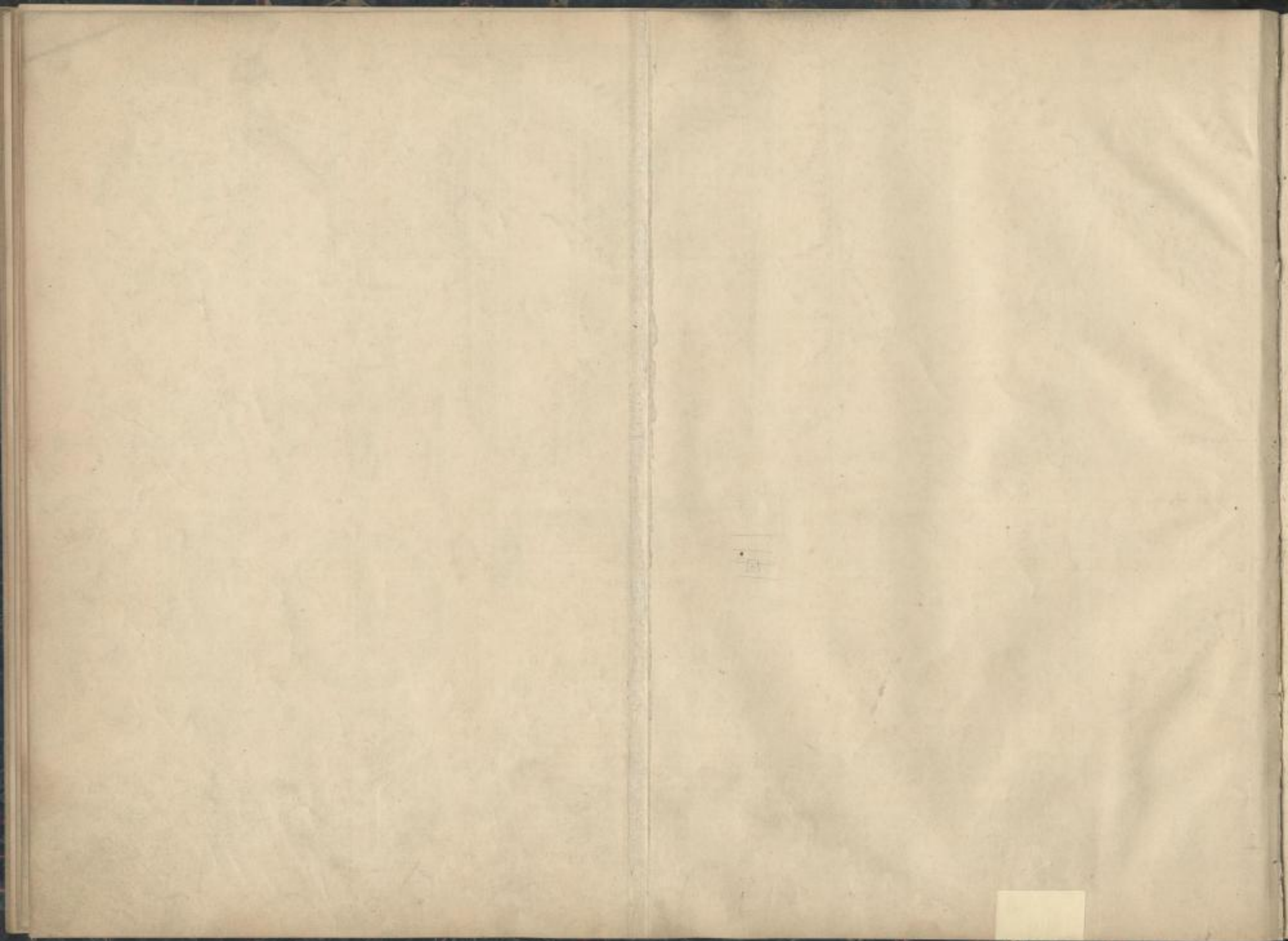

SLUB

Wir führen Wissen.

<http://digital.slub-dresden.de/id446692875/56>



TECHNISCHE UNIVERSITÄT
CHEMNITZ

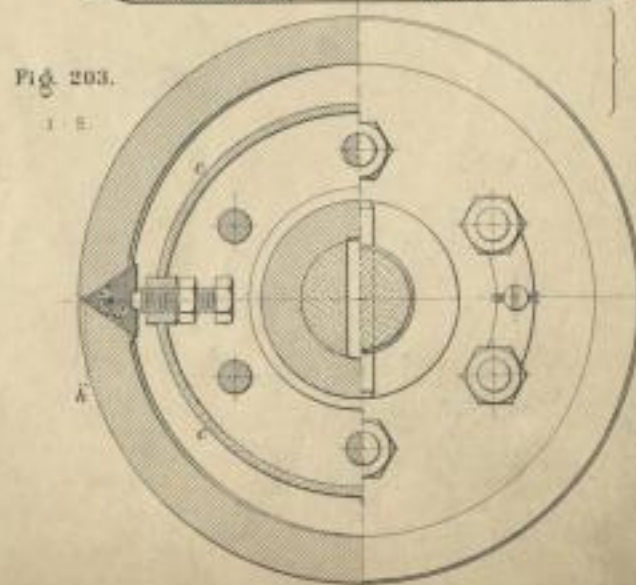
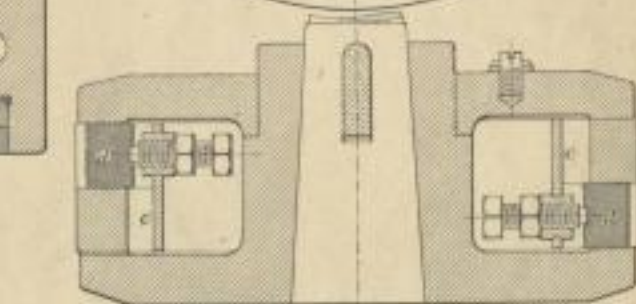
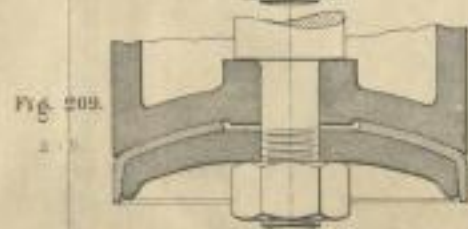
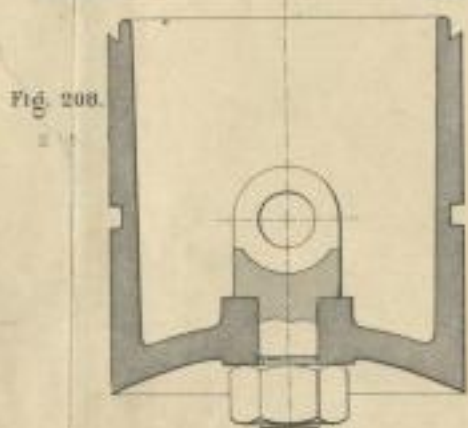
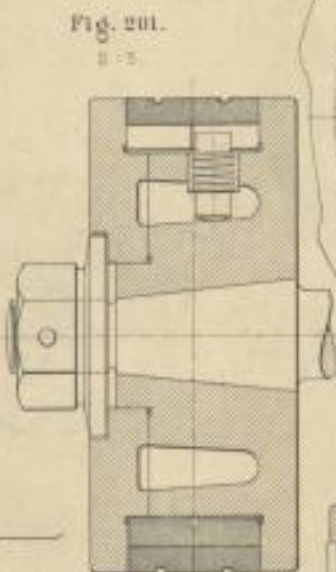
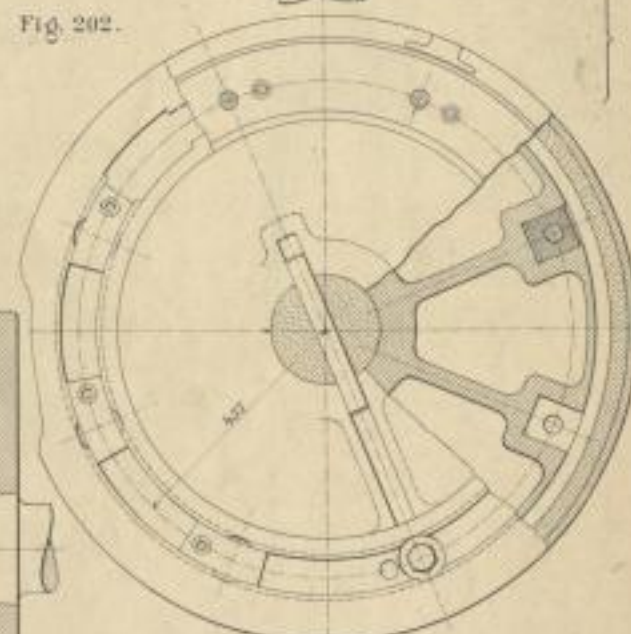
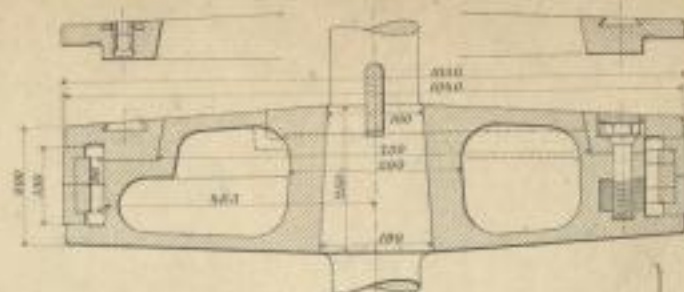
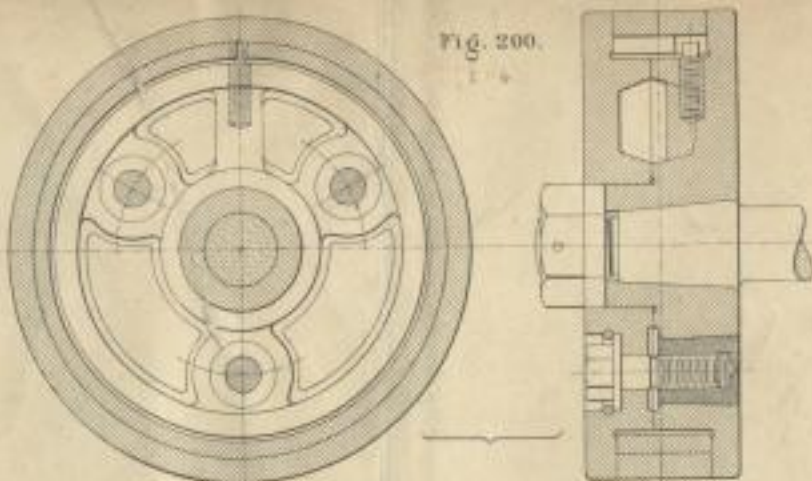
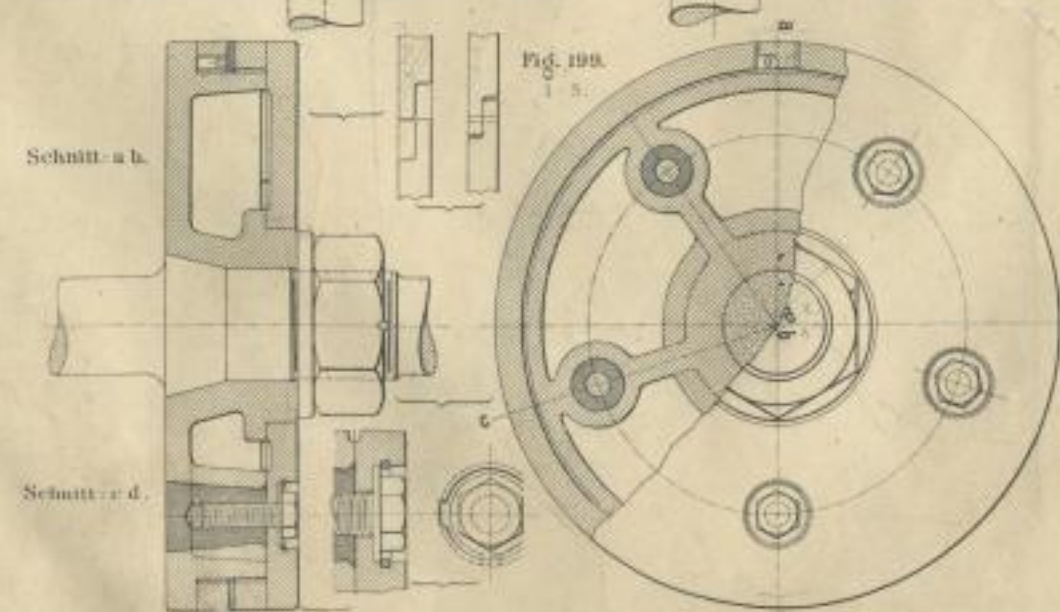
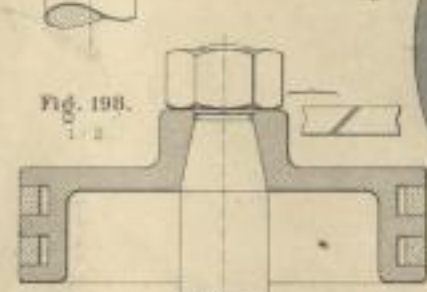
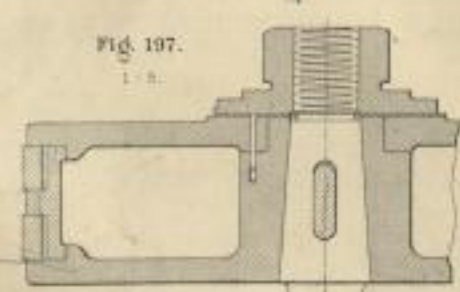
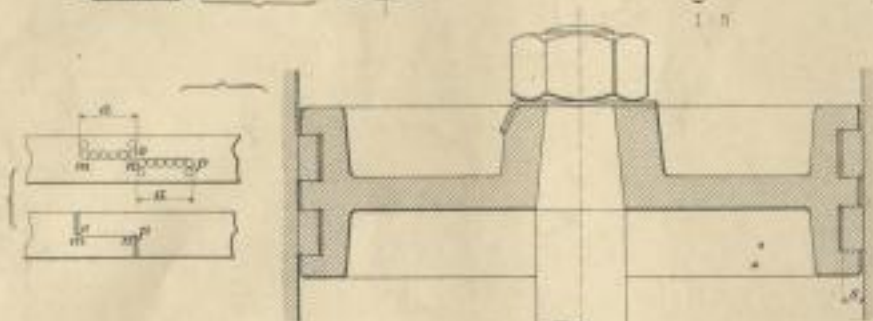
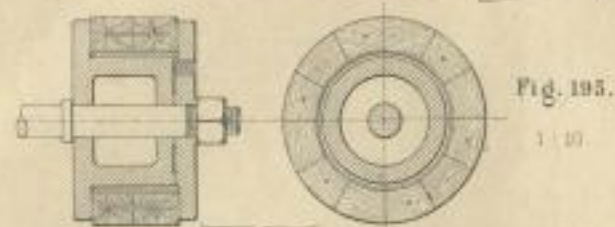
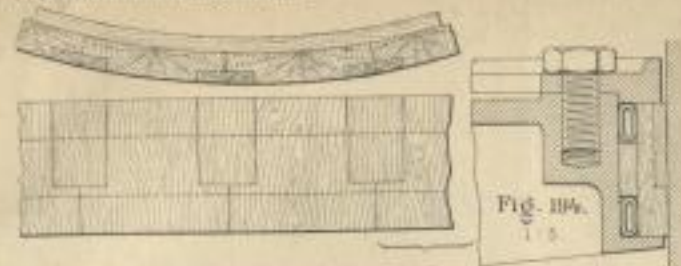



SLUB

Wir führen Wissen.

<http://digital.slub-dresden.de/id446692875/58>



TECHNISCHE UNIVERSITÄT
CHEMNITZ



Fig. 204.

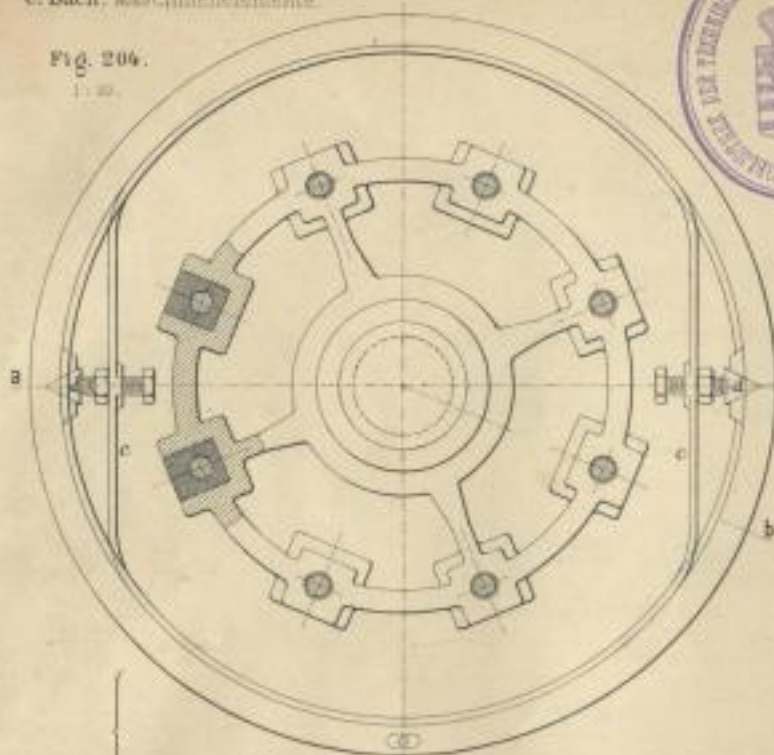

Schnitt: a b.

Fig. 206.

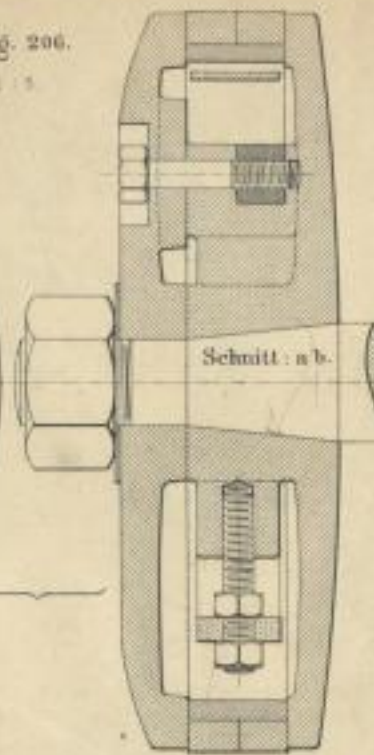
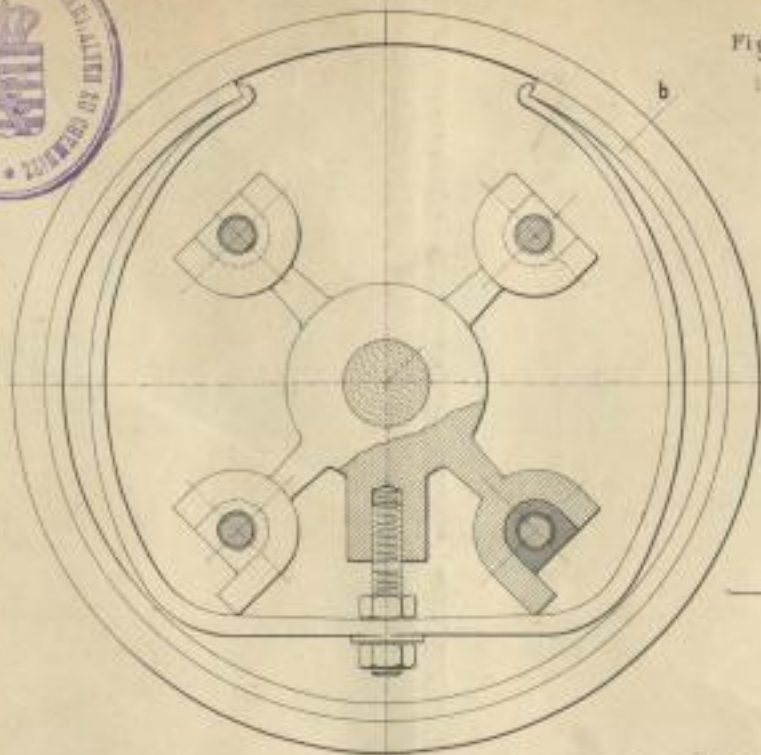

Fig. 211.

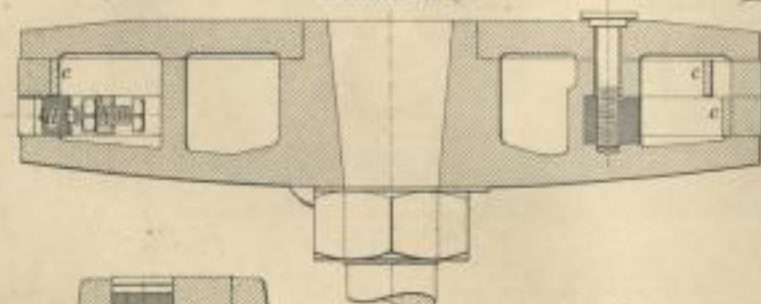
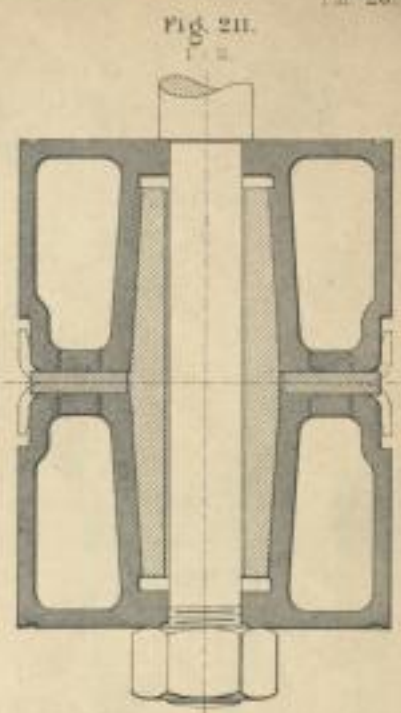
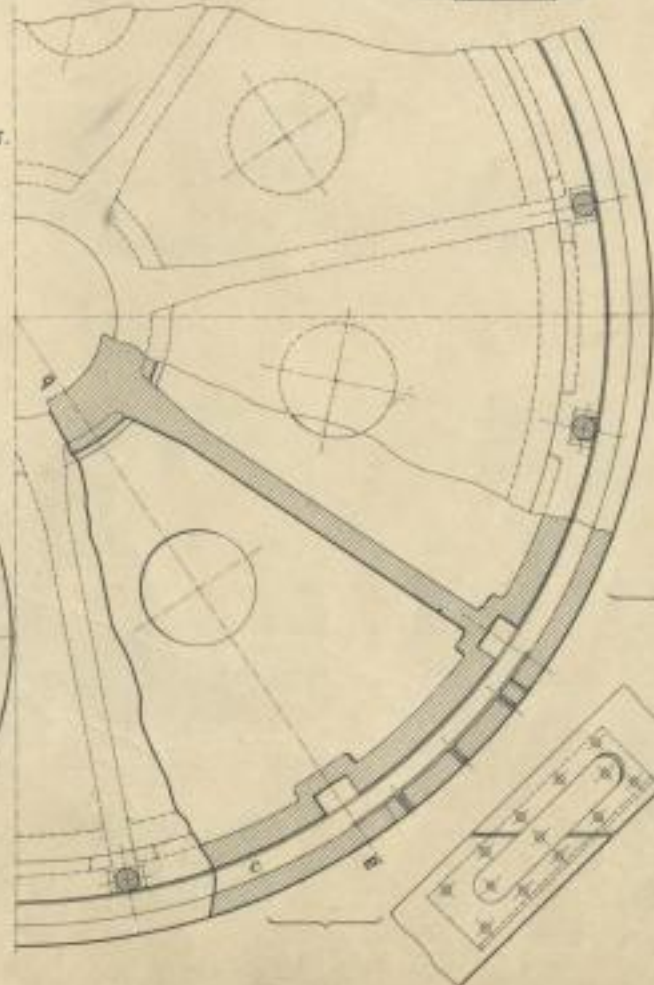

Fig. 207.



Schnitt: a b.

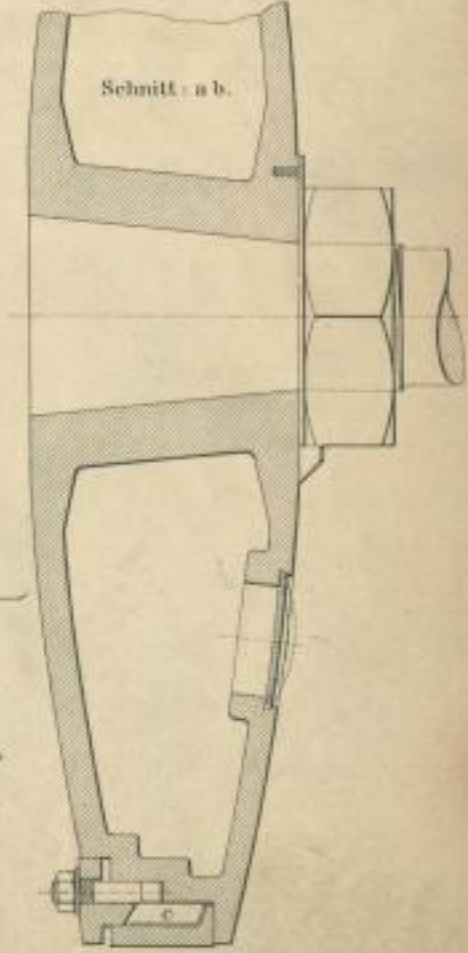
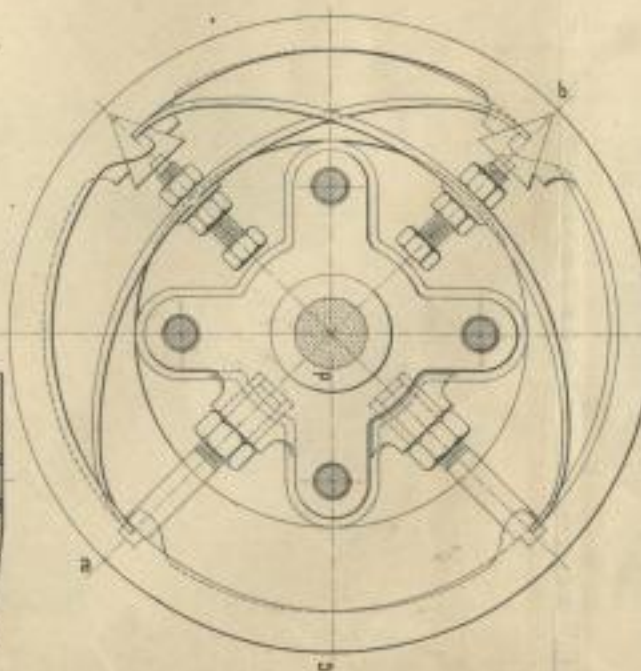
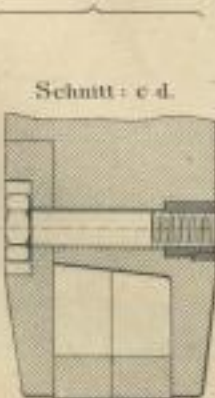
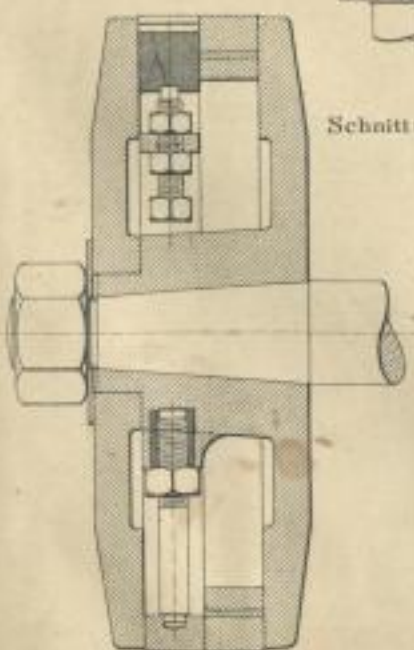

Fig. 205.



Lith. Anst. v. J. Wern. Eisenach

$\frac{h - h - \rho - \rho}{2} + S + a_3$
 $\frac{e_{11} + e_{12}}{2}$
 $e = \frac{h}{2}$



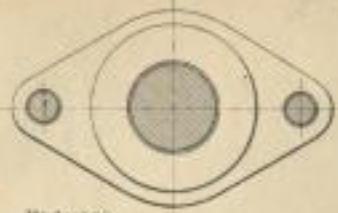

Fig. 212.
1:5

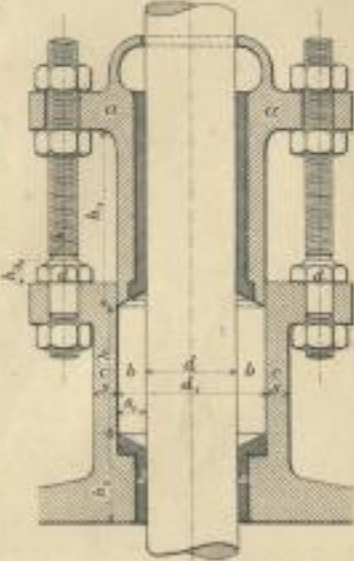

Fig. 213. 1:5

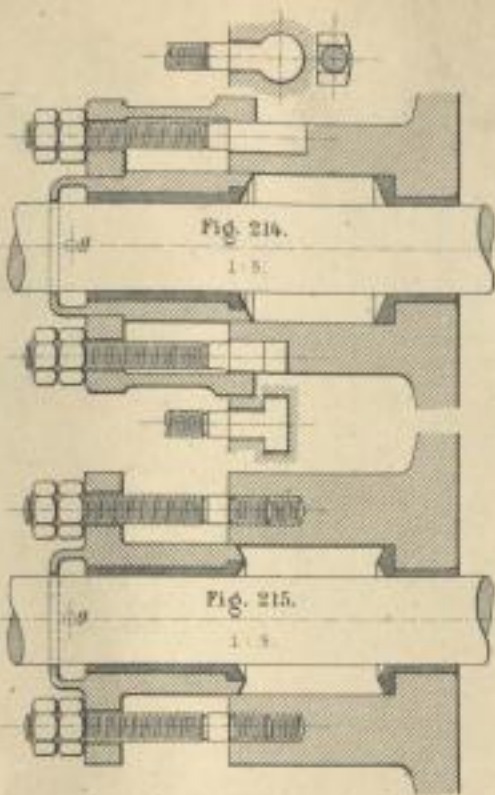

Fig. 214.
1:5

Fig. 215.
1:5

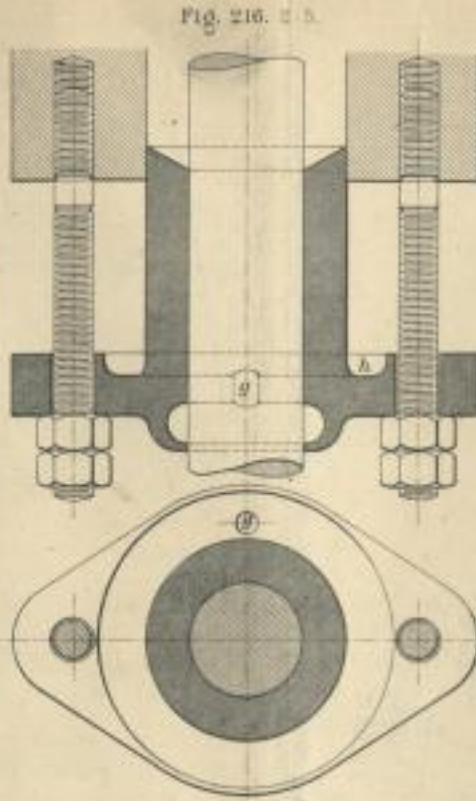

Fig. 216. 1:5

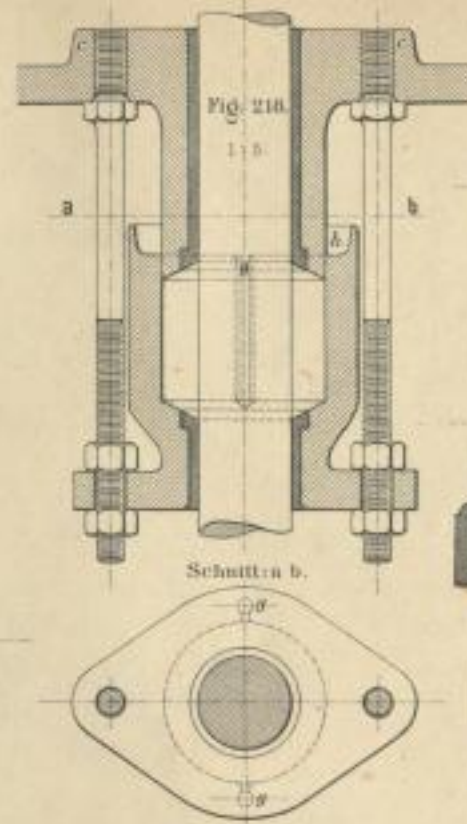

Fig. 218.
1:5

Schnitt a.

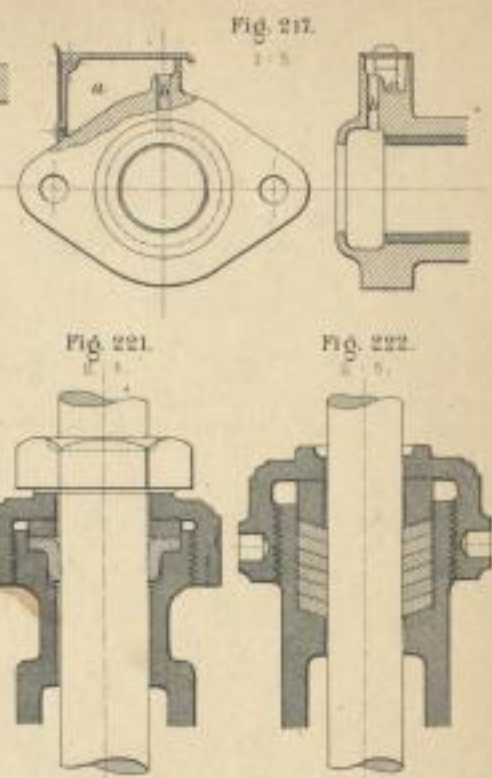

Fig. 217.
1:5

Fig. 221.
1:5

Fig. 222.
1:5

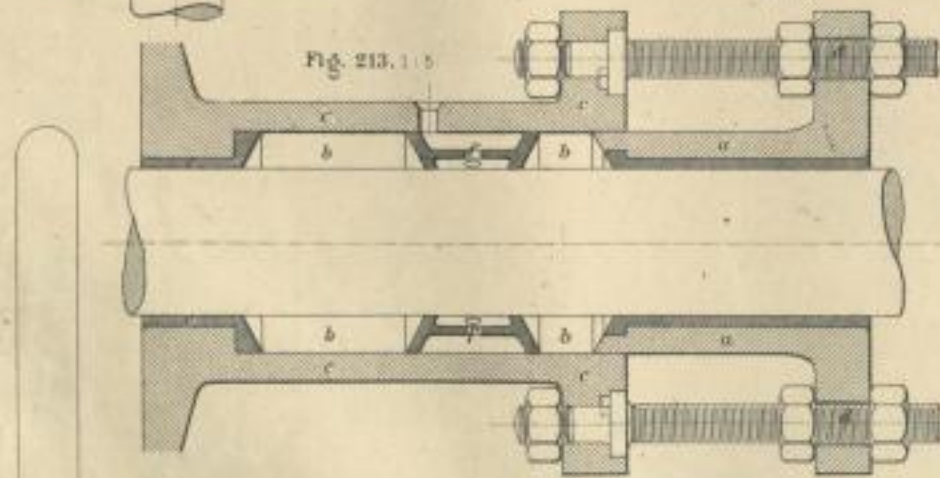

Fig. 213. 1:5

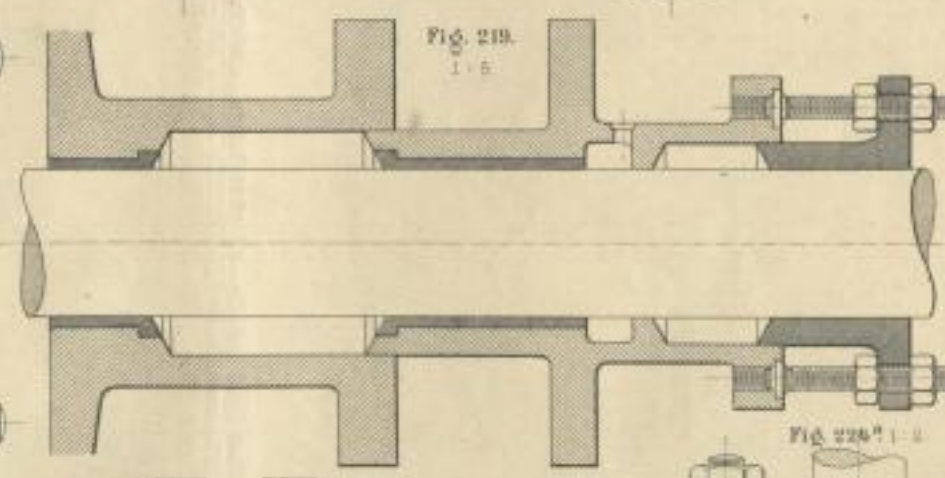

Fig. 219.
1:5

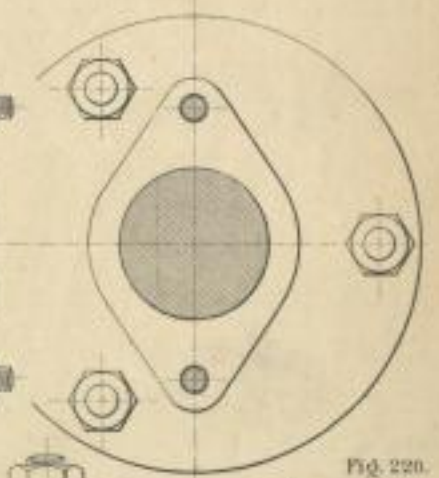

Fig. 220^a 1:5

Fig. 220.
1:5

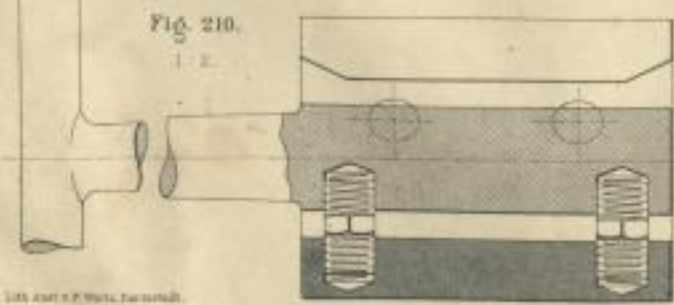

Fig. 210.
1:2

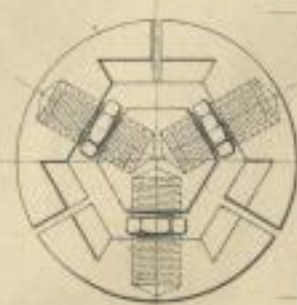
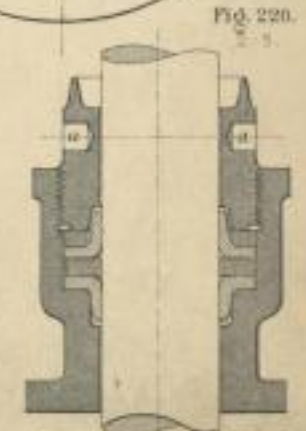
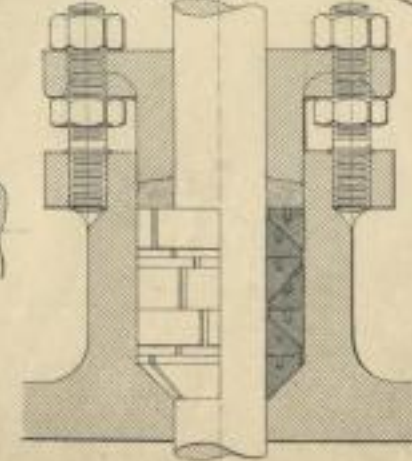
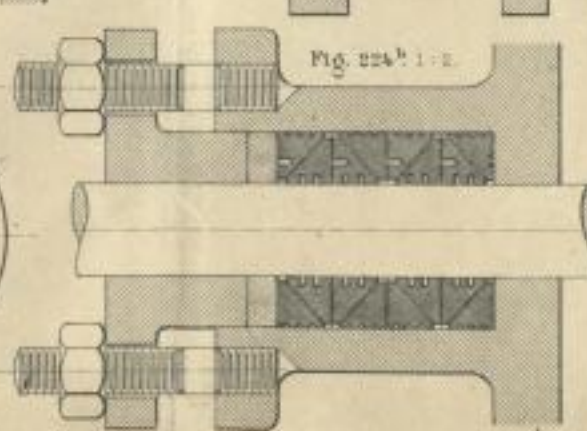

Fig. 224^a 1:2



VERLAG VON WILHELM FRIEDRICH



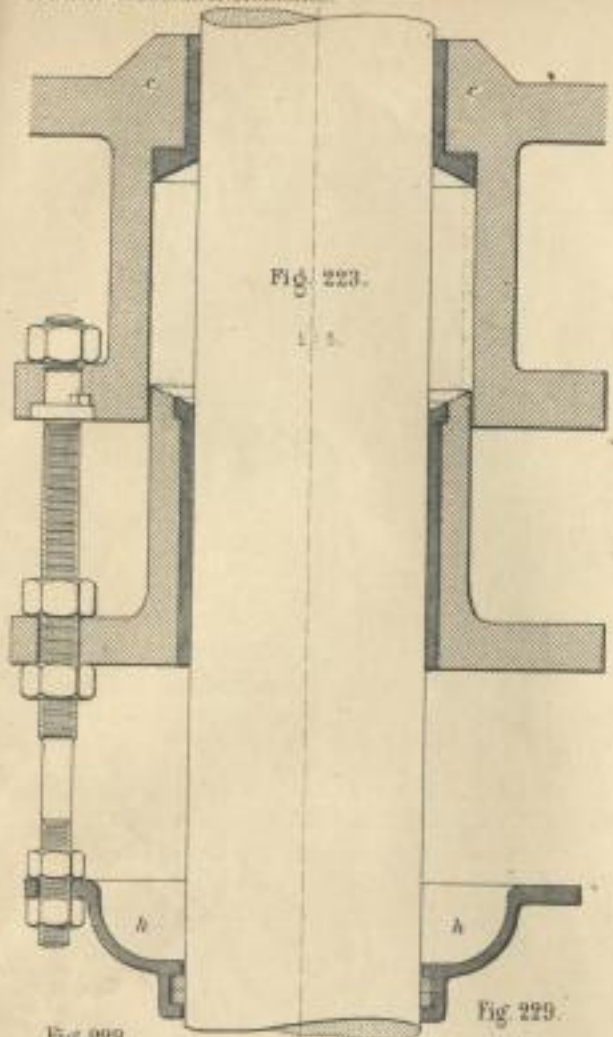

Fig. 223.

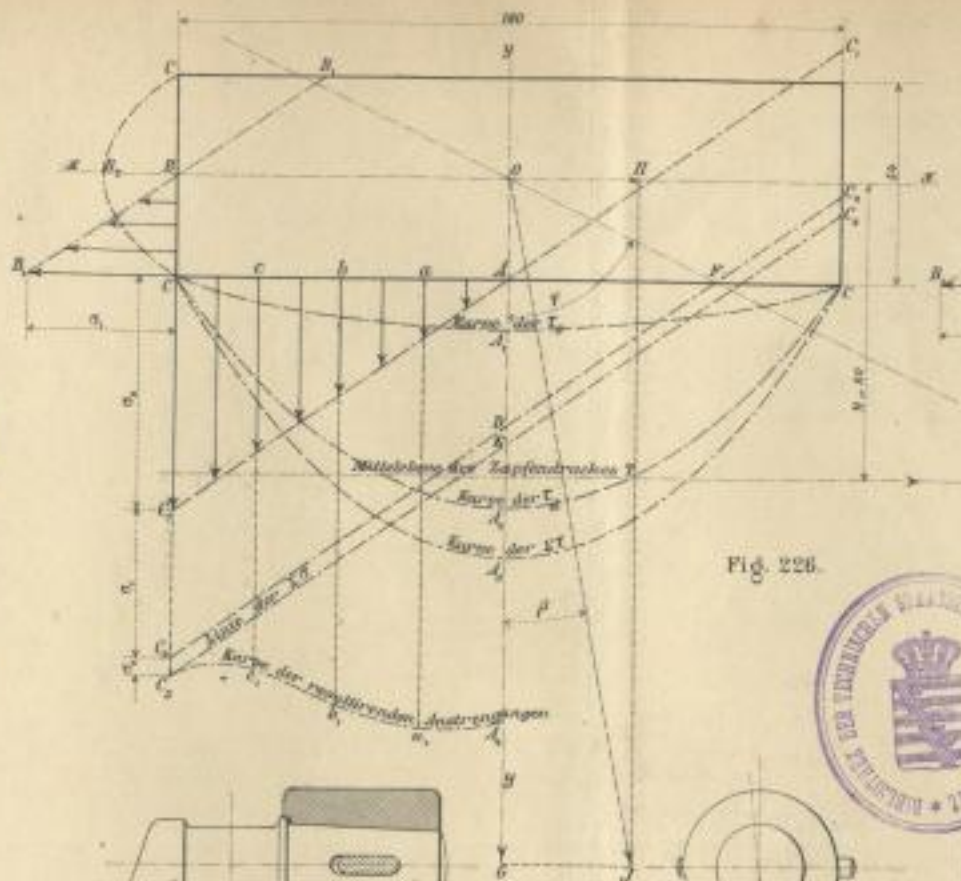

Fig. 226.

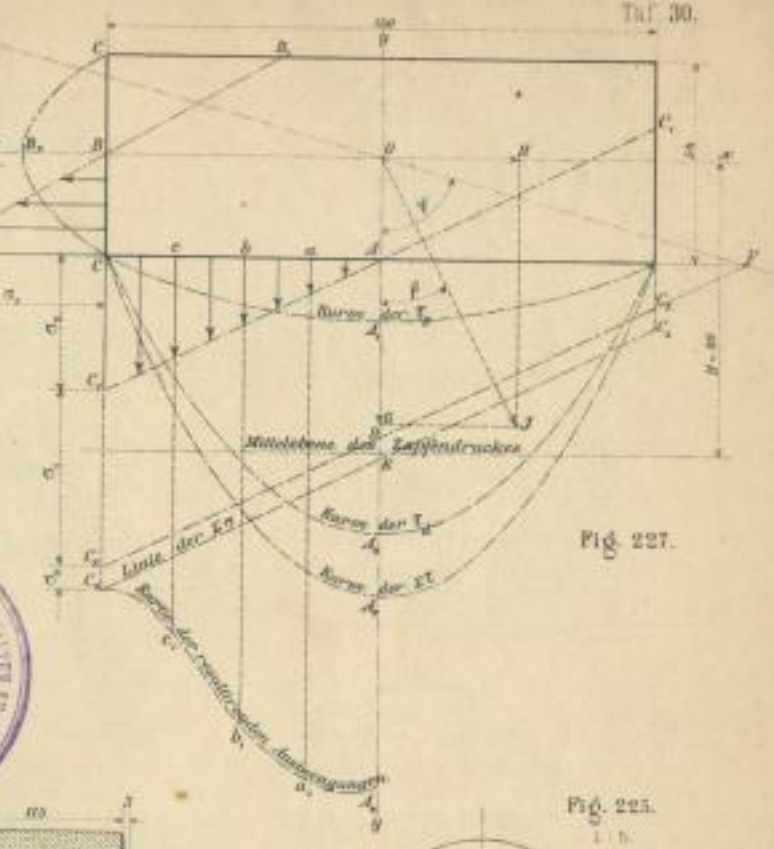

Fig. 227.

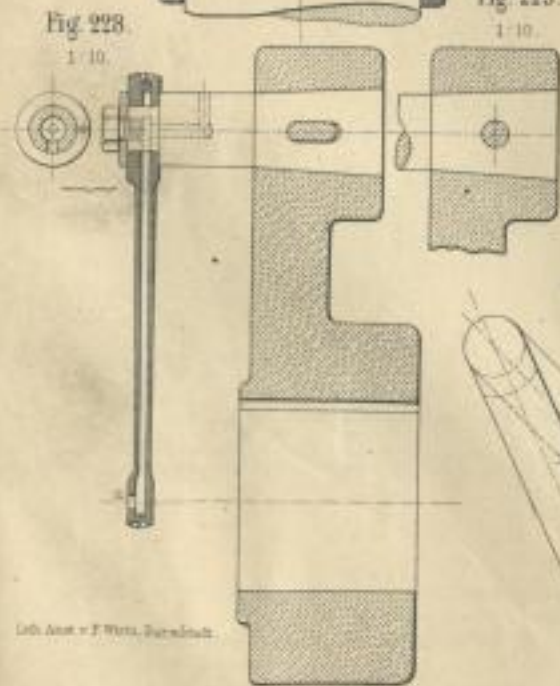

Fig. 228.

Fig. 229.

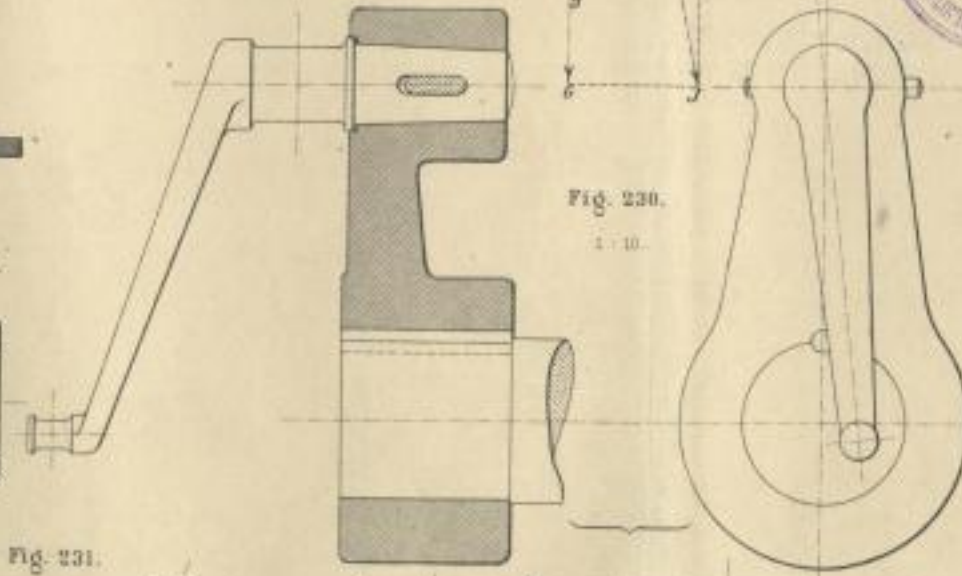

Fig. 230.

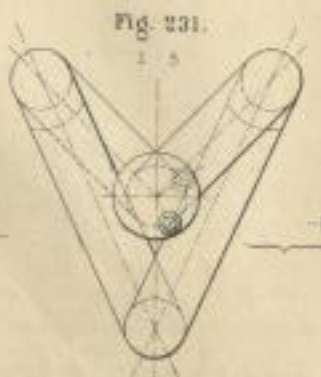

Fig. 231.

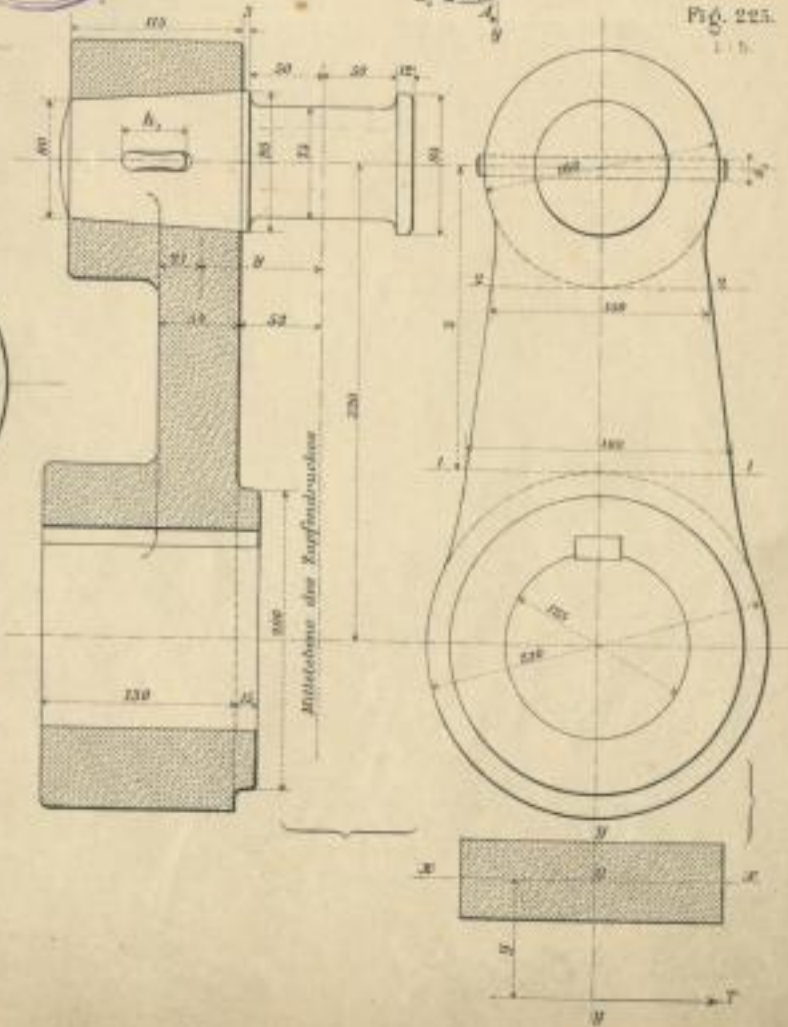

Fig. 225.

Leh. Ass. v. F. Witt, Dresden.



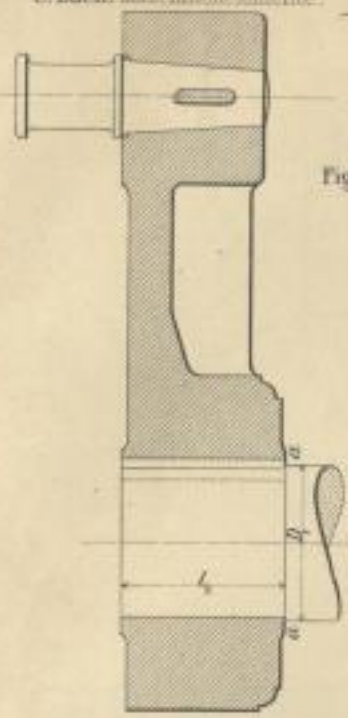

Fig. 232.
1:10

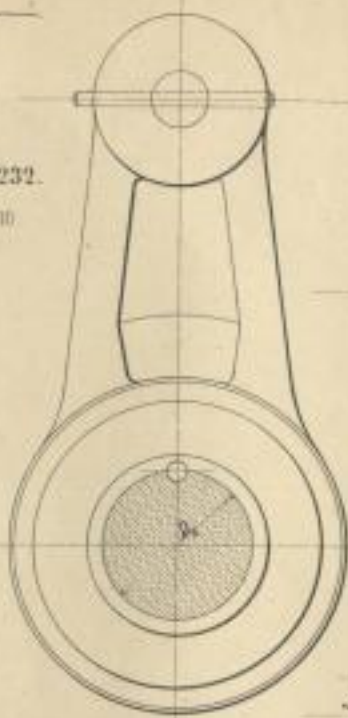

Fig. 233.
1:5

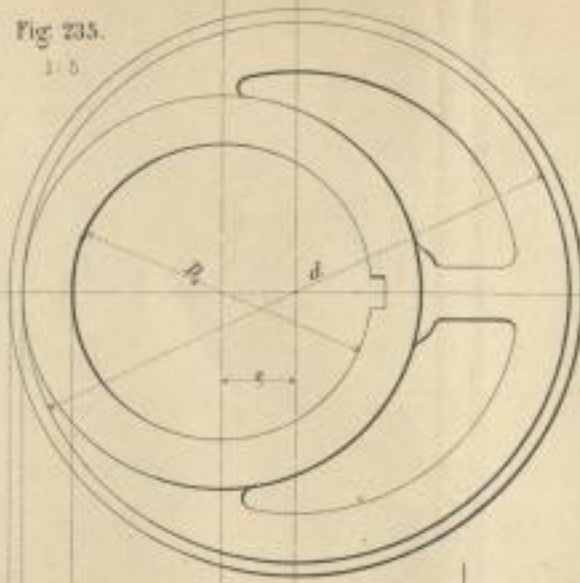

Fig. 235.
1:5

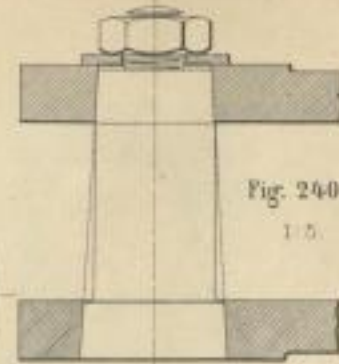

Fig. 240.
1:5

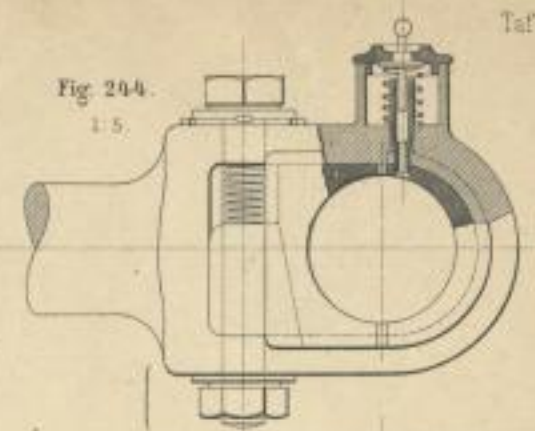

Fig. 244.
1:5

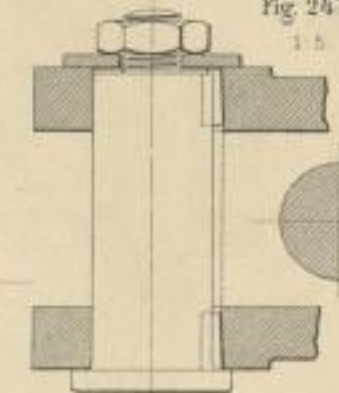

Fig. 241.
1:5

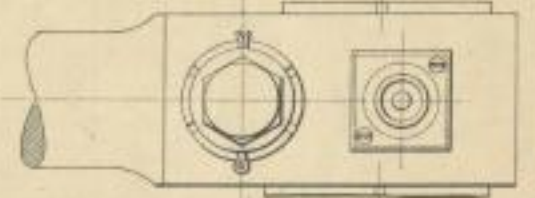

Fig. 238.
1:5

Fig. 237.
1:5

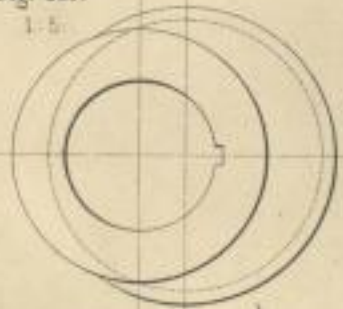
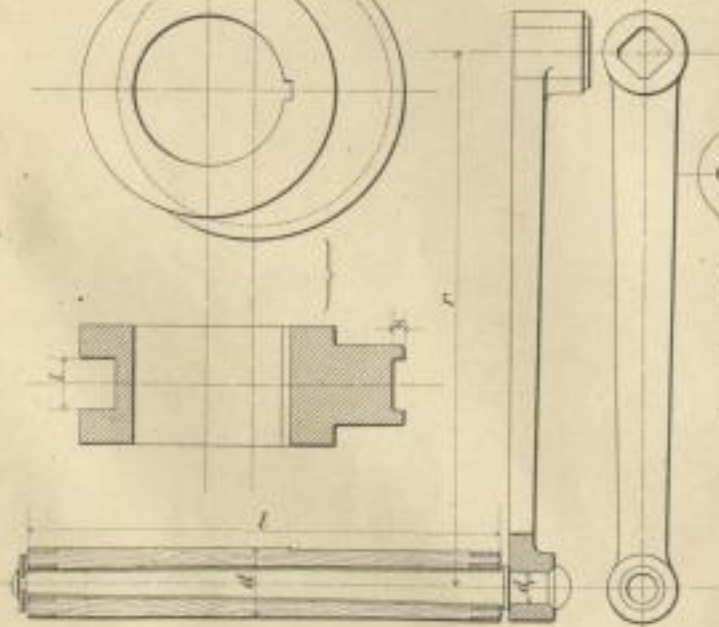
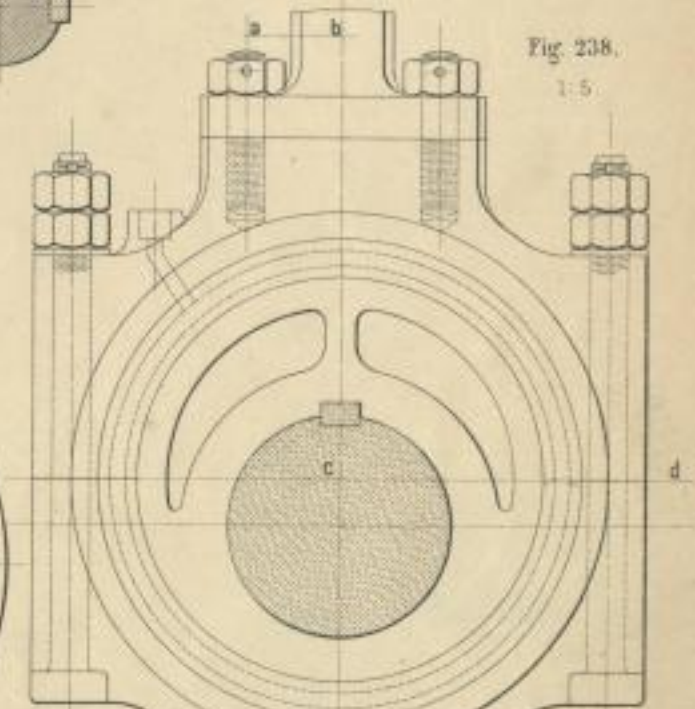
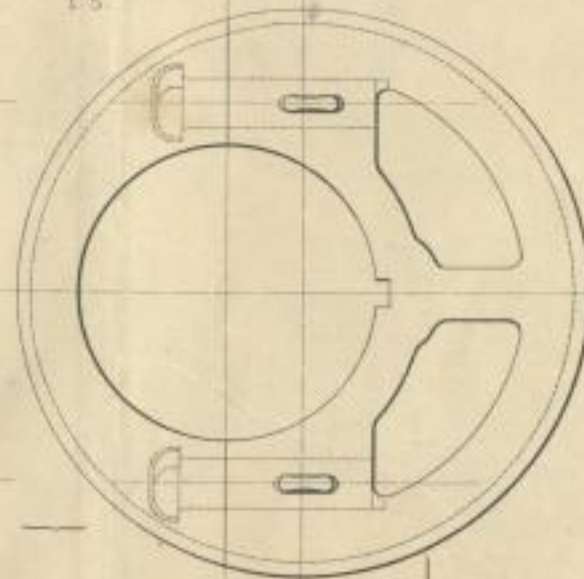

Fig. 234.
1:5

Fig. 236.
1:5



Lith. Inst. v. F. Witz, Dessau



Schnitt abcd.





Fig. 239
1:5

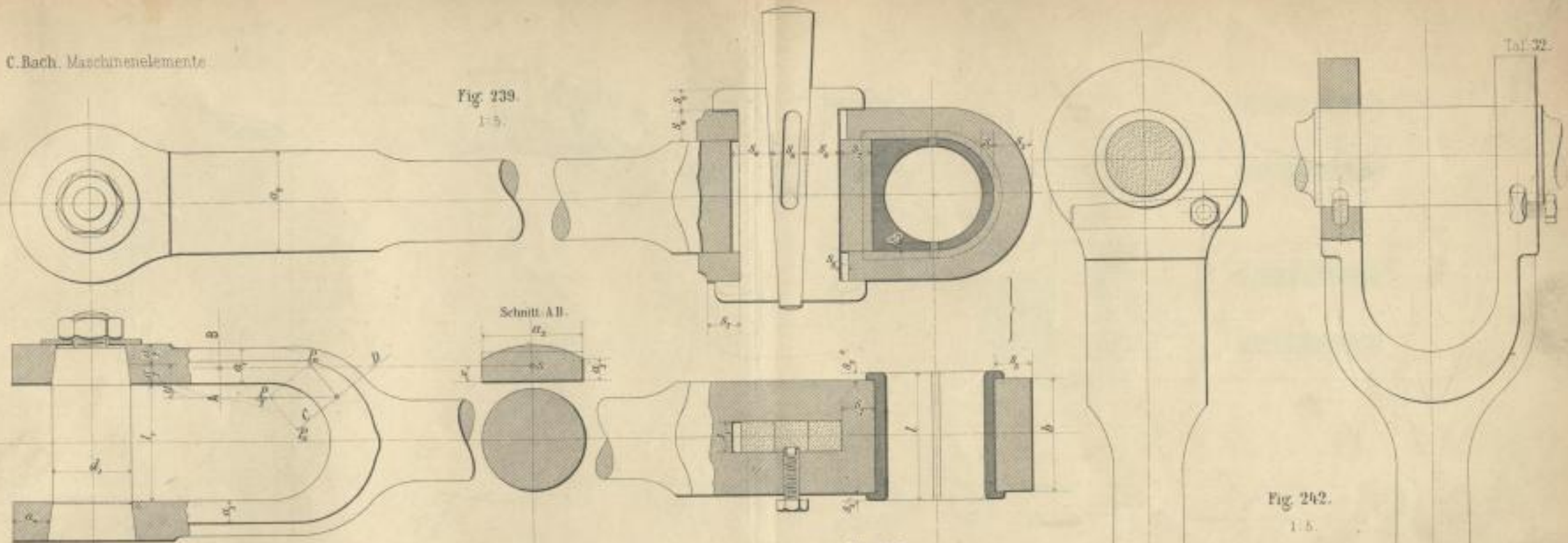

Fig. 243
1:10

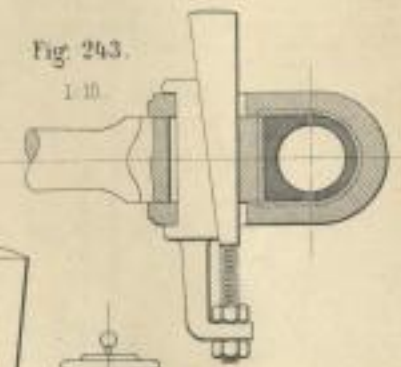

Fig. 245
1:15

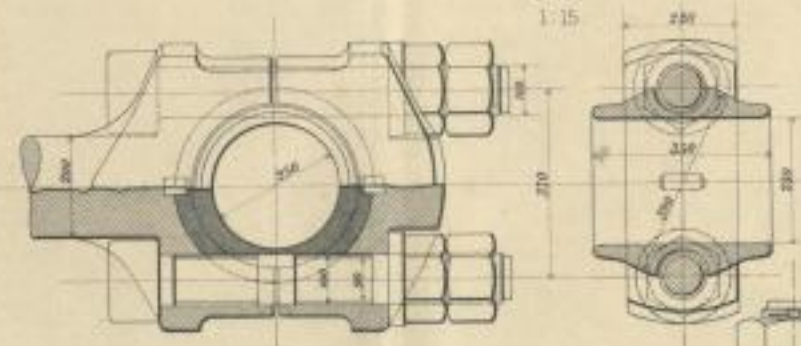
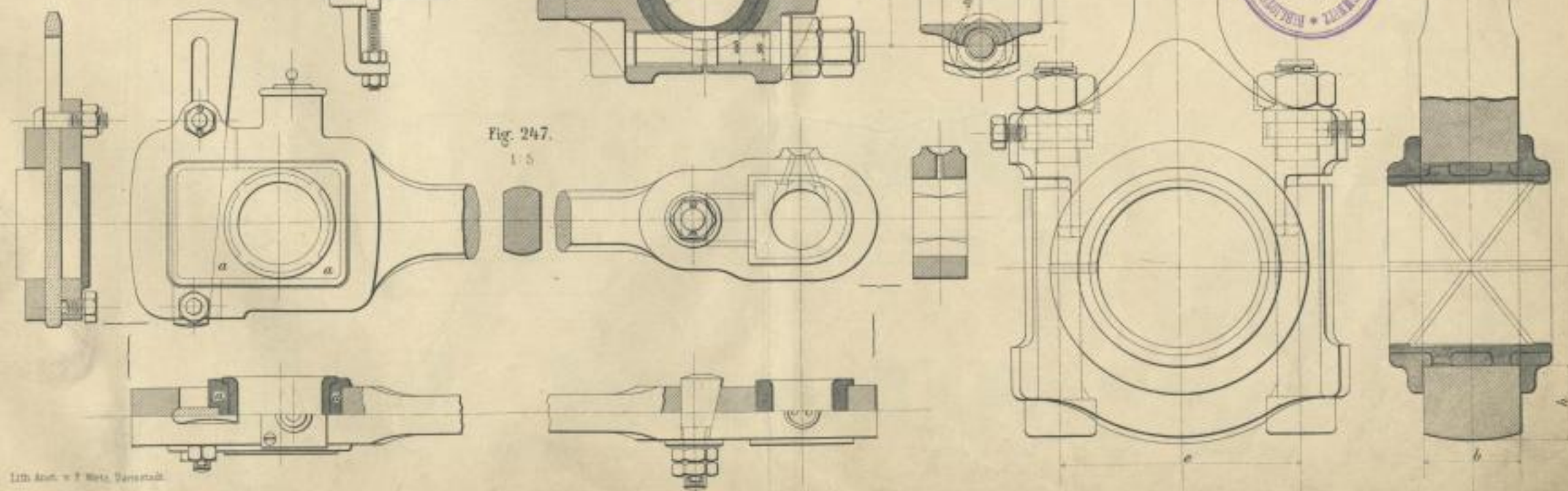

Fig. 242
1:5

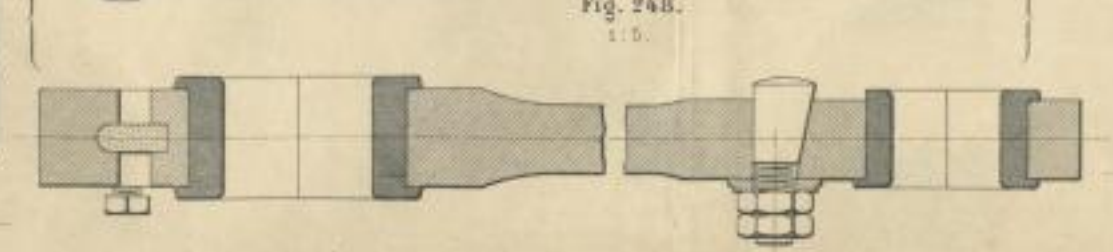
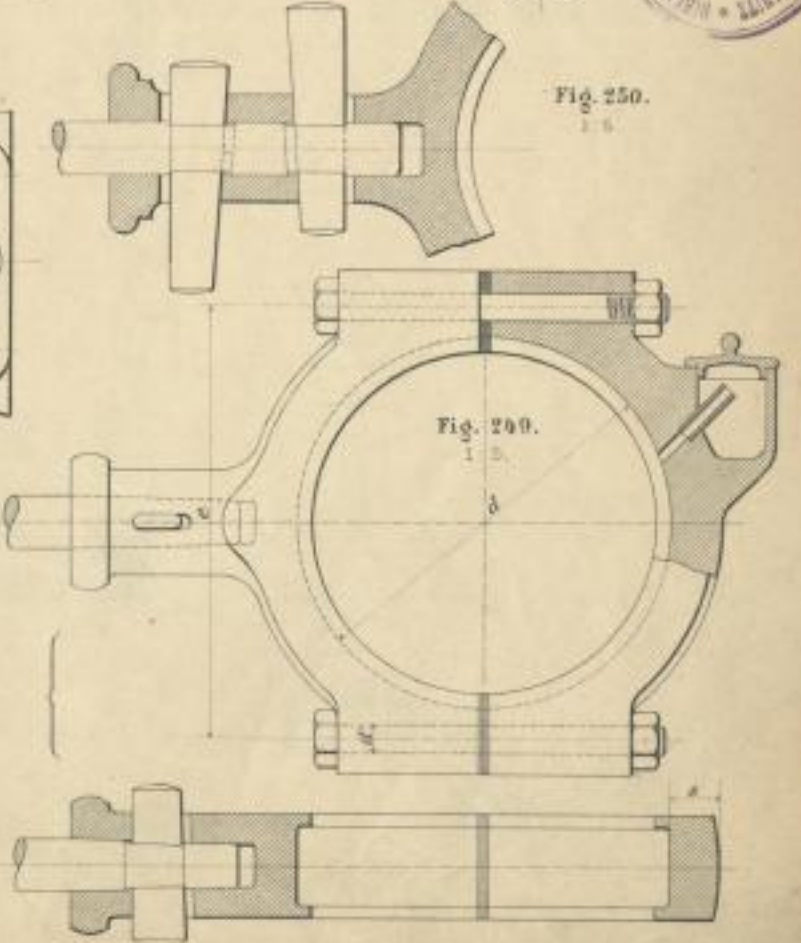
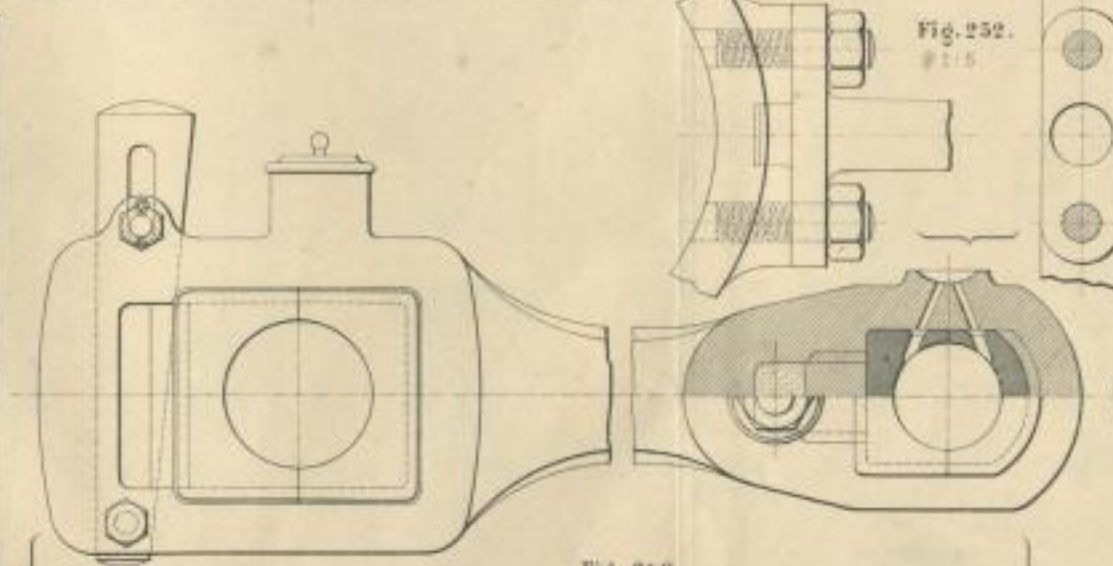
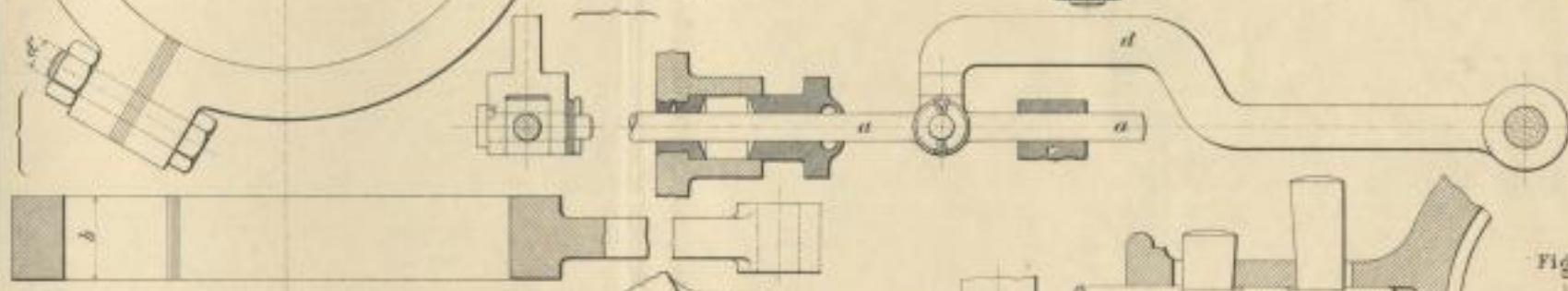
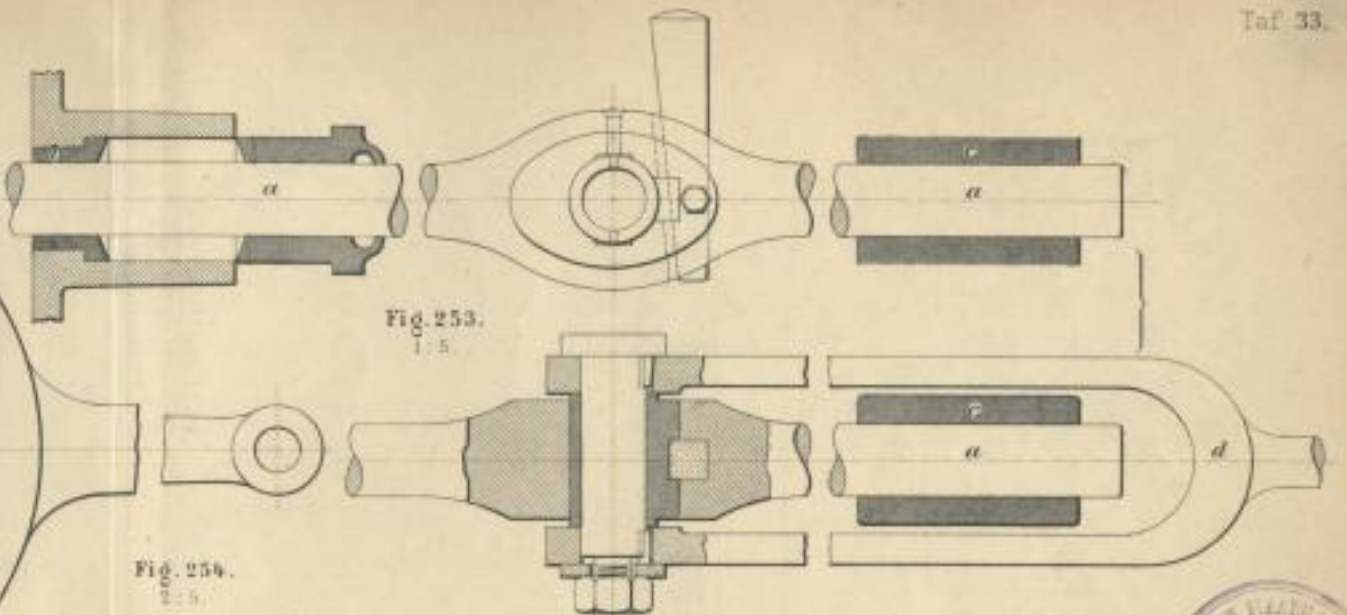
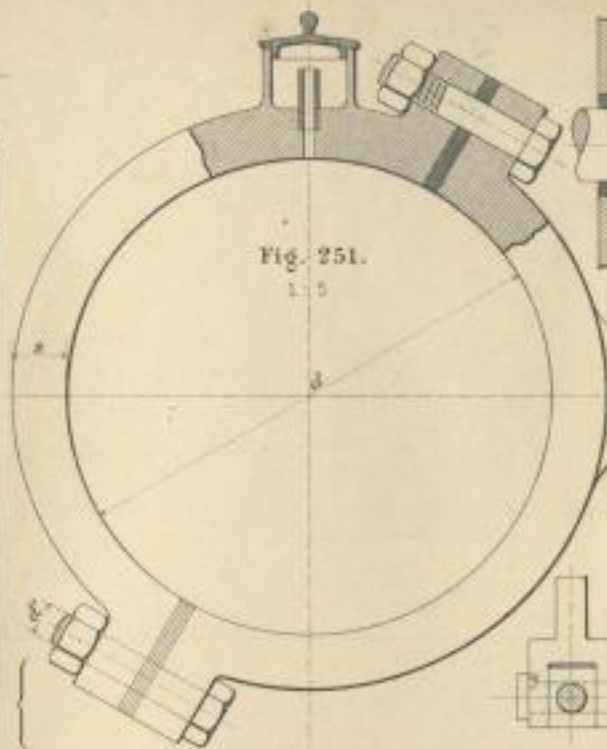
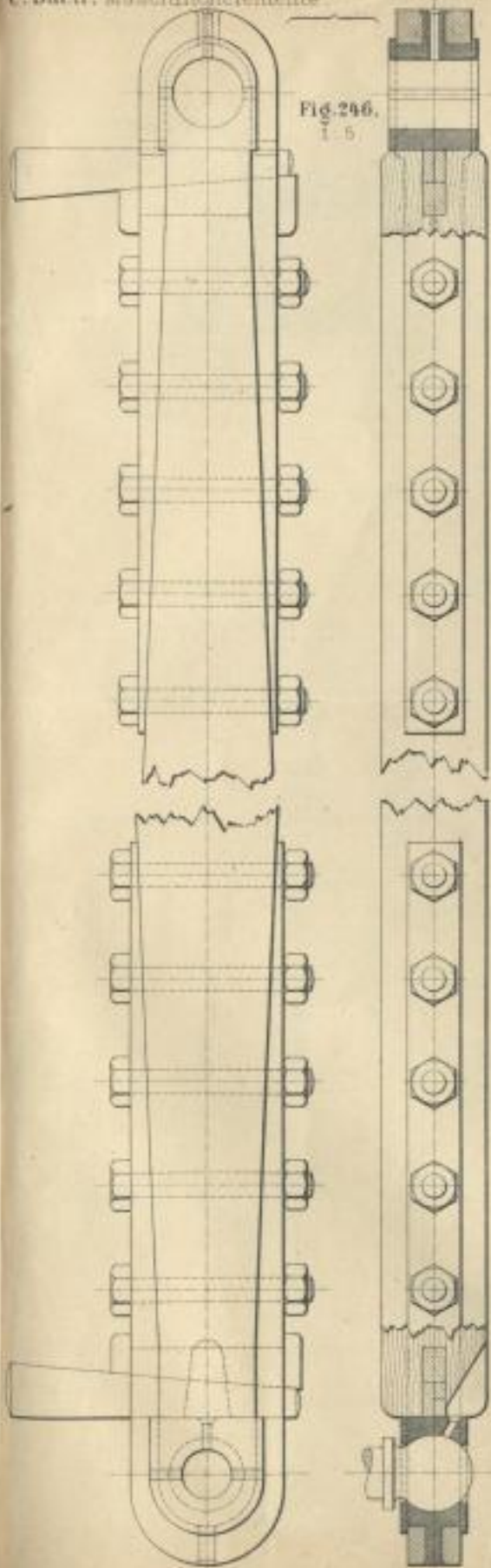

Fig. 247
1:5



Lith. Anst. v. F. Metz, Dresden







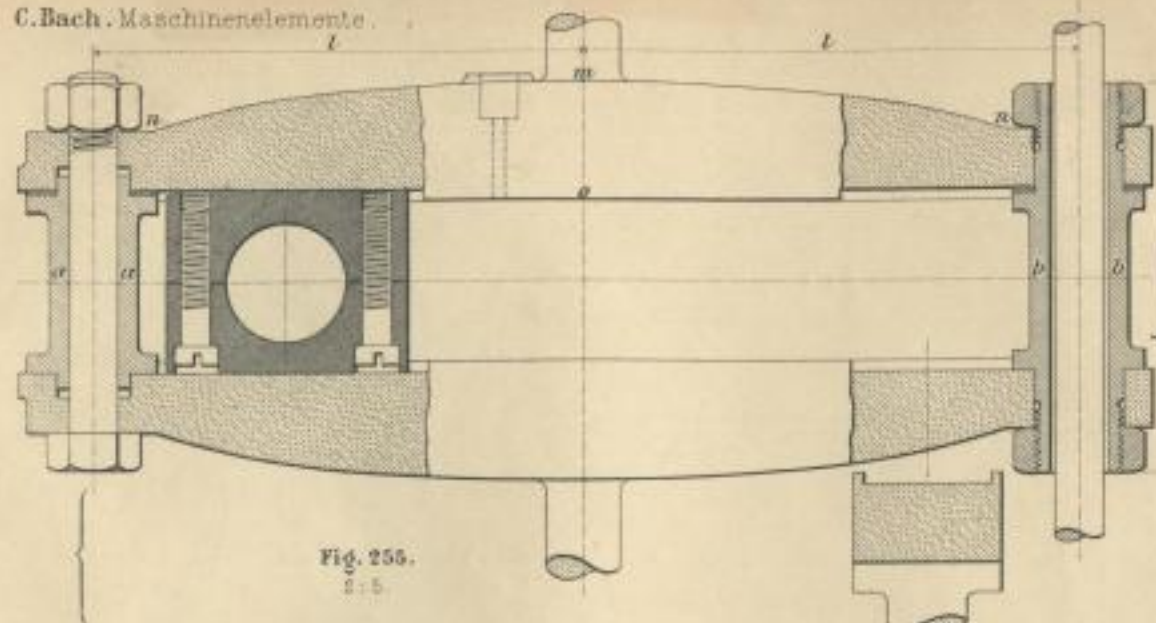

Fig. 255.
2:5

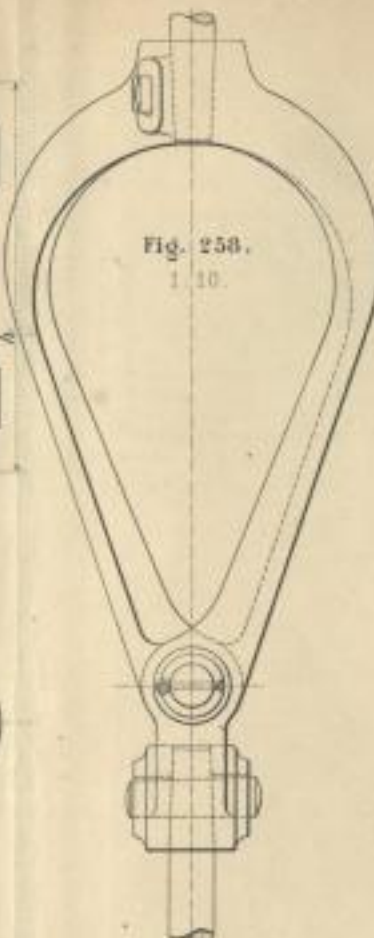

Fig. 258.
1:10

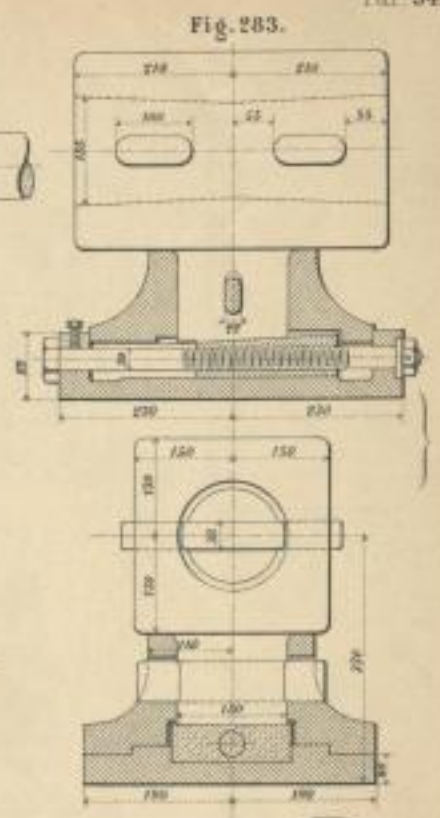
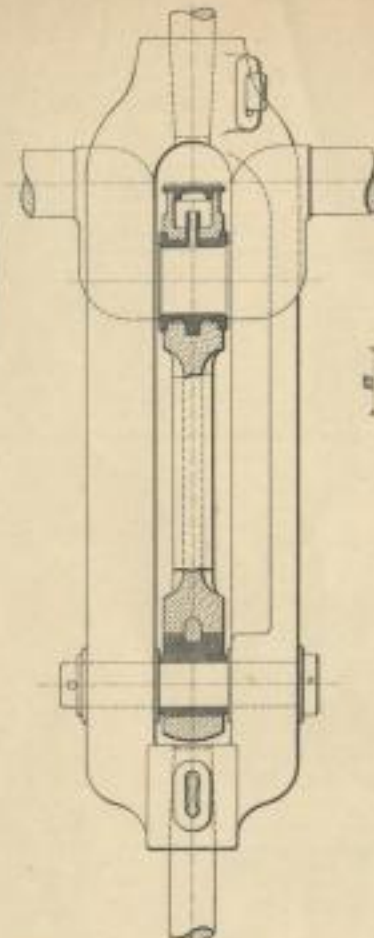

Fig. 283.

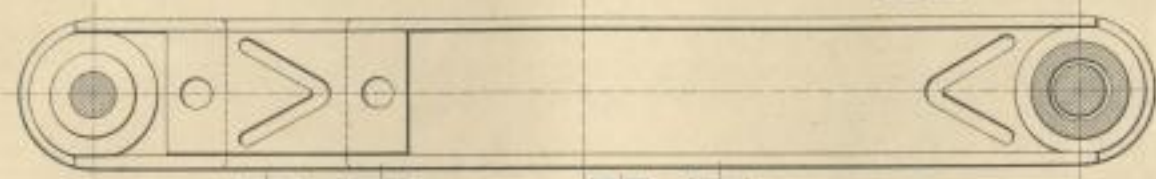

Fig. 257.
1:2

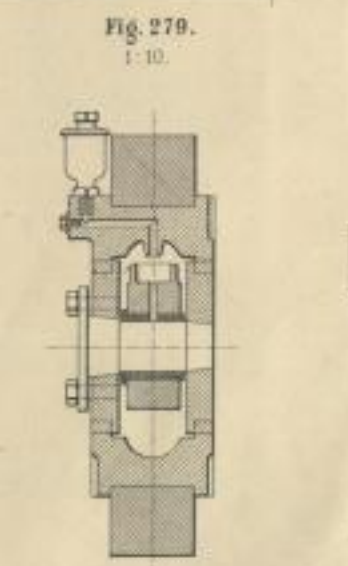

Fig. 279.
1:10

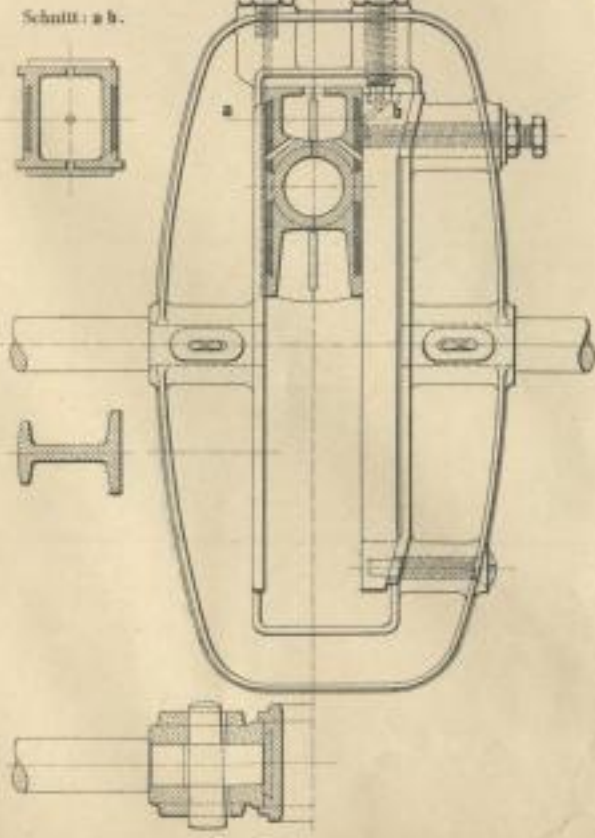

Fig. 256.
2:5

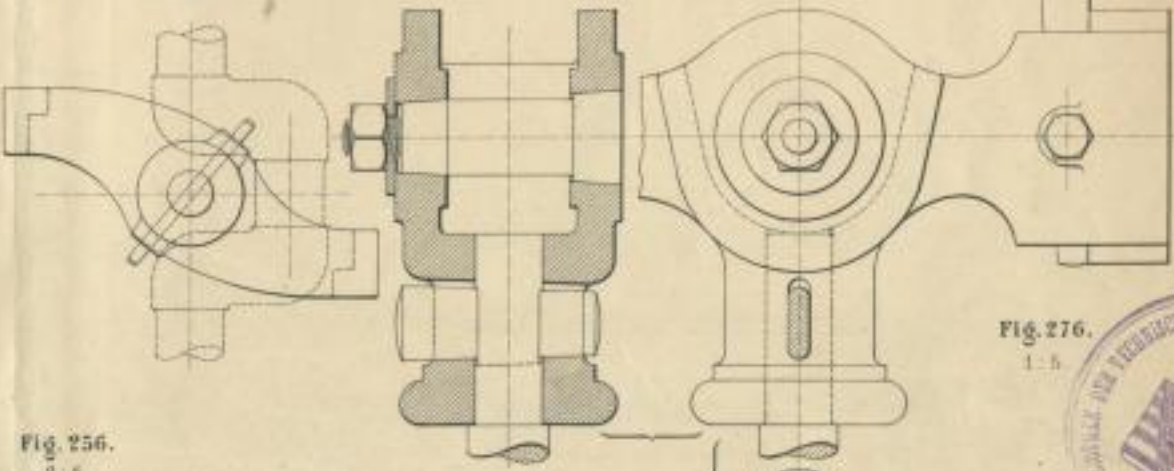

Fig. 276.
1:5

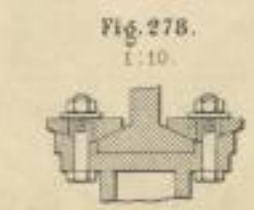
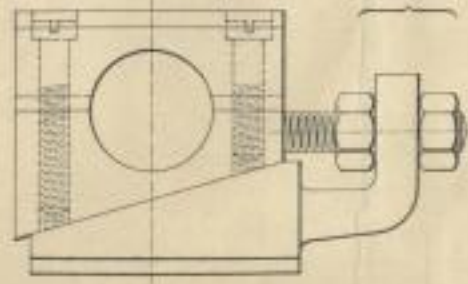
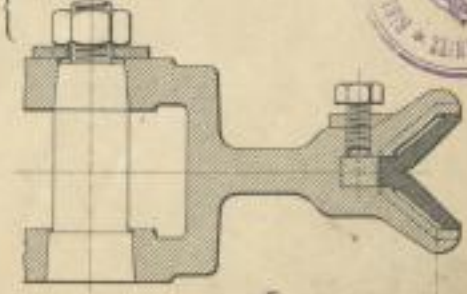

Fig. 278.
1:10



Loth. Anst. v. F. Wietz, Darmstadt





SLUB

Wir führen Wissen.

<http://digital.slub-dresden.de/id446692875/72>



TECHNISCHE UNIVERSITÄT
CHEMNITZ

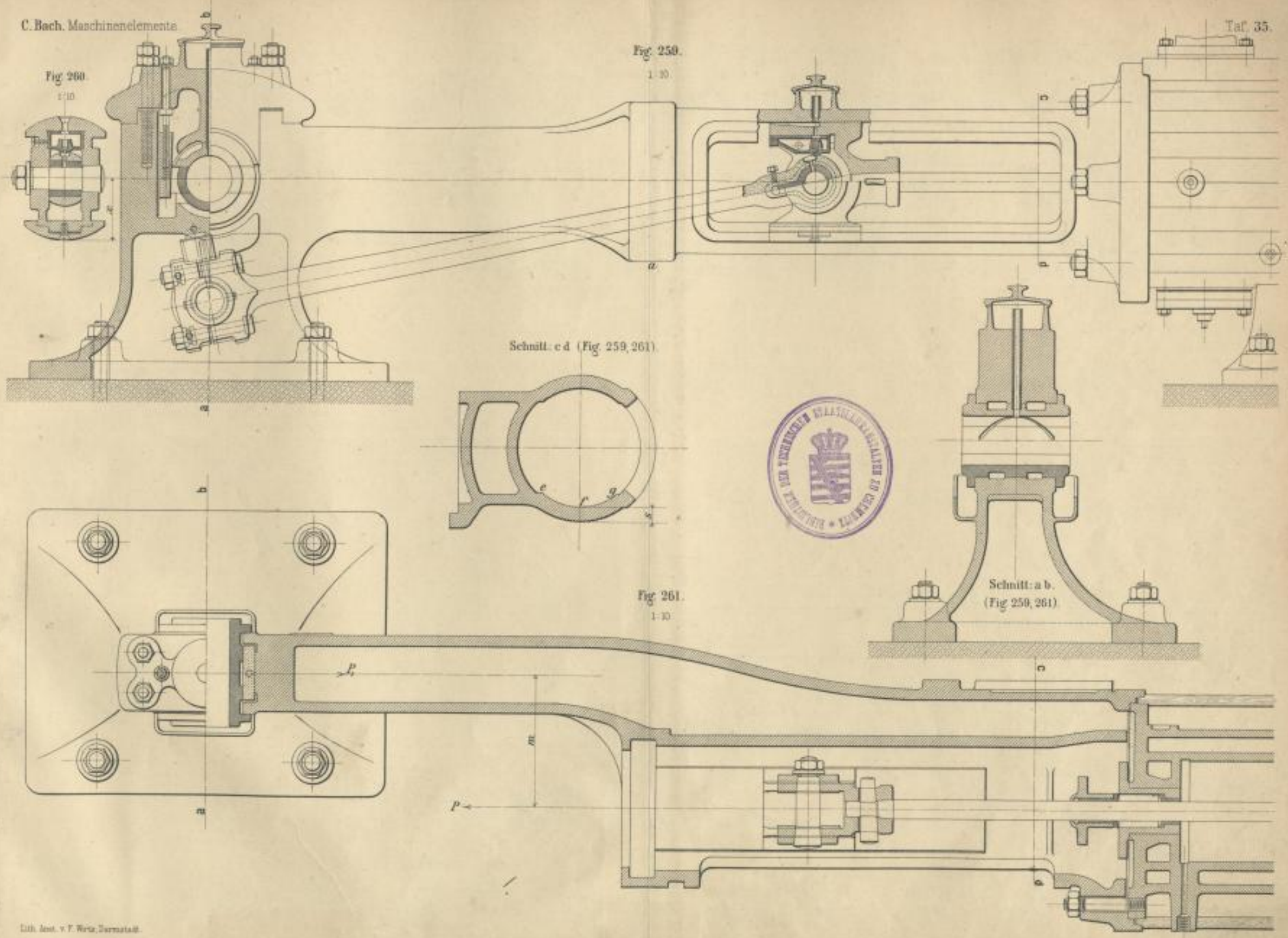

Lith. Anst. v. F. Witz, Darmstadt.

Fig. 263.
1:10

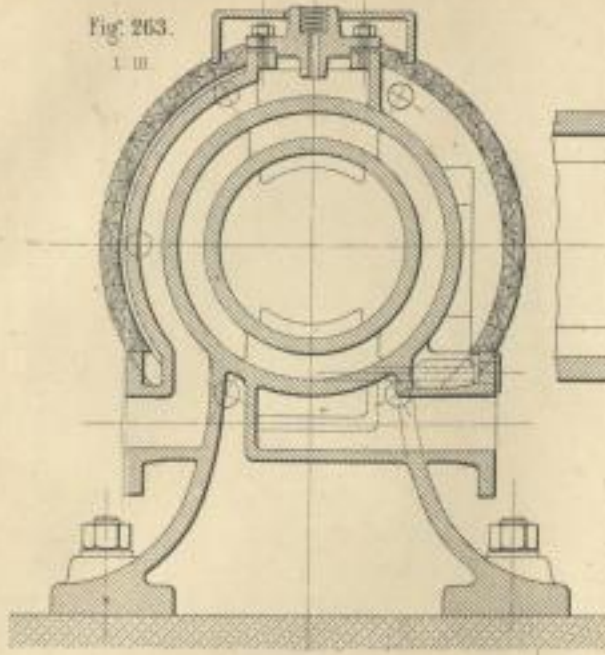

Fig. 262.
1:10

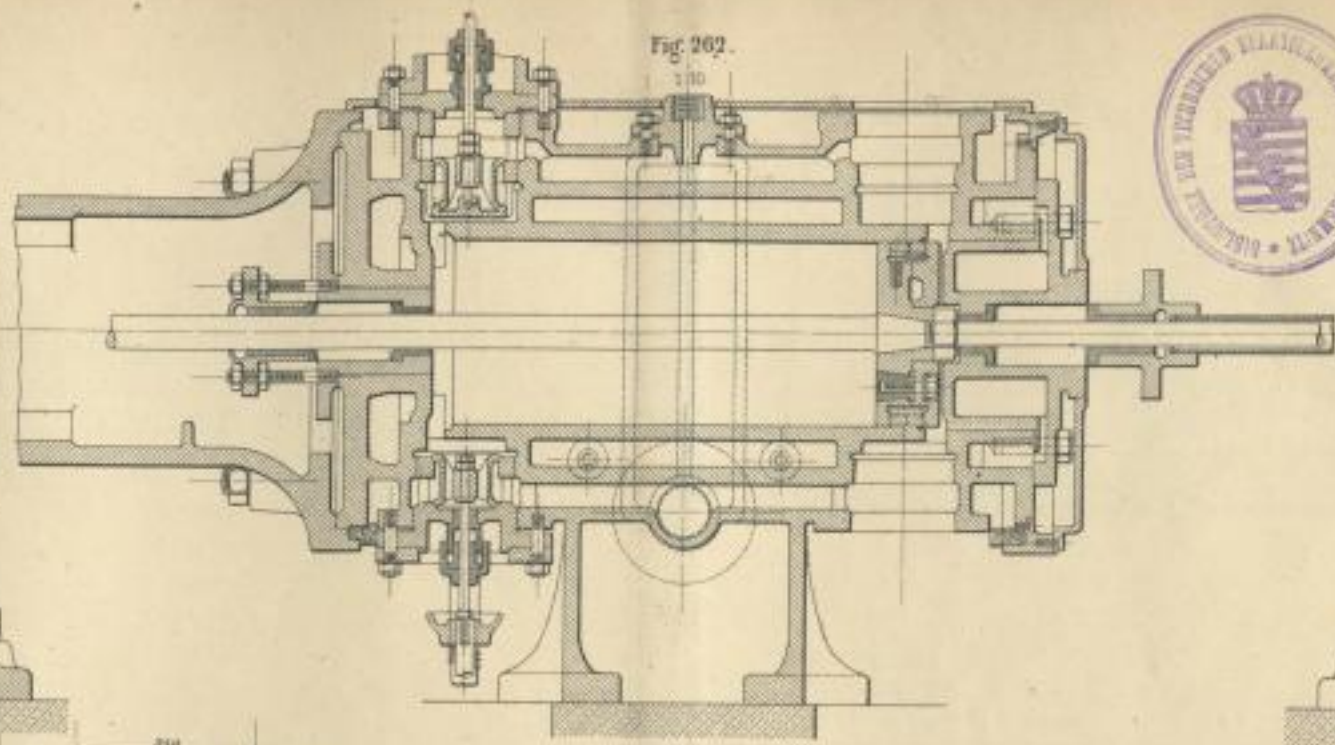

Fig. 264.
1:10

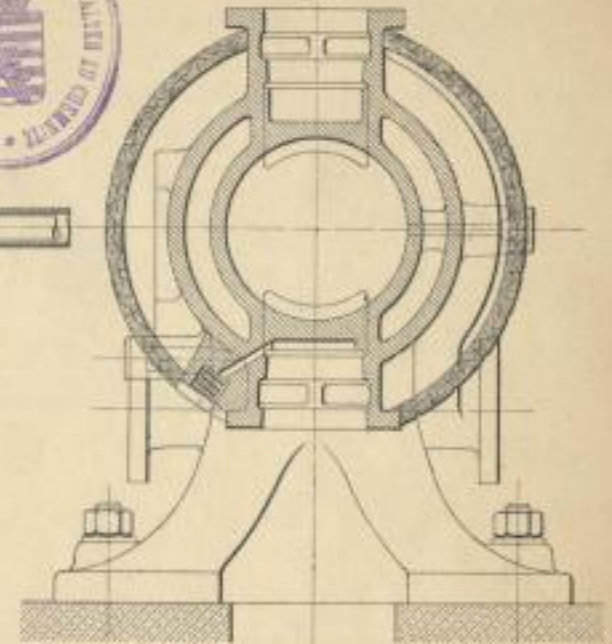

Fig. 268.
1:15

Schnitt. a b.
In der Richtung des Pfeiles gesehen.

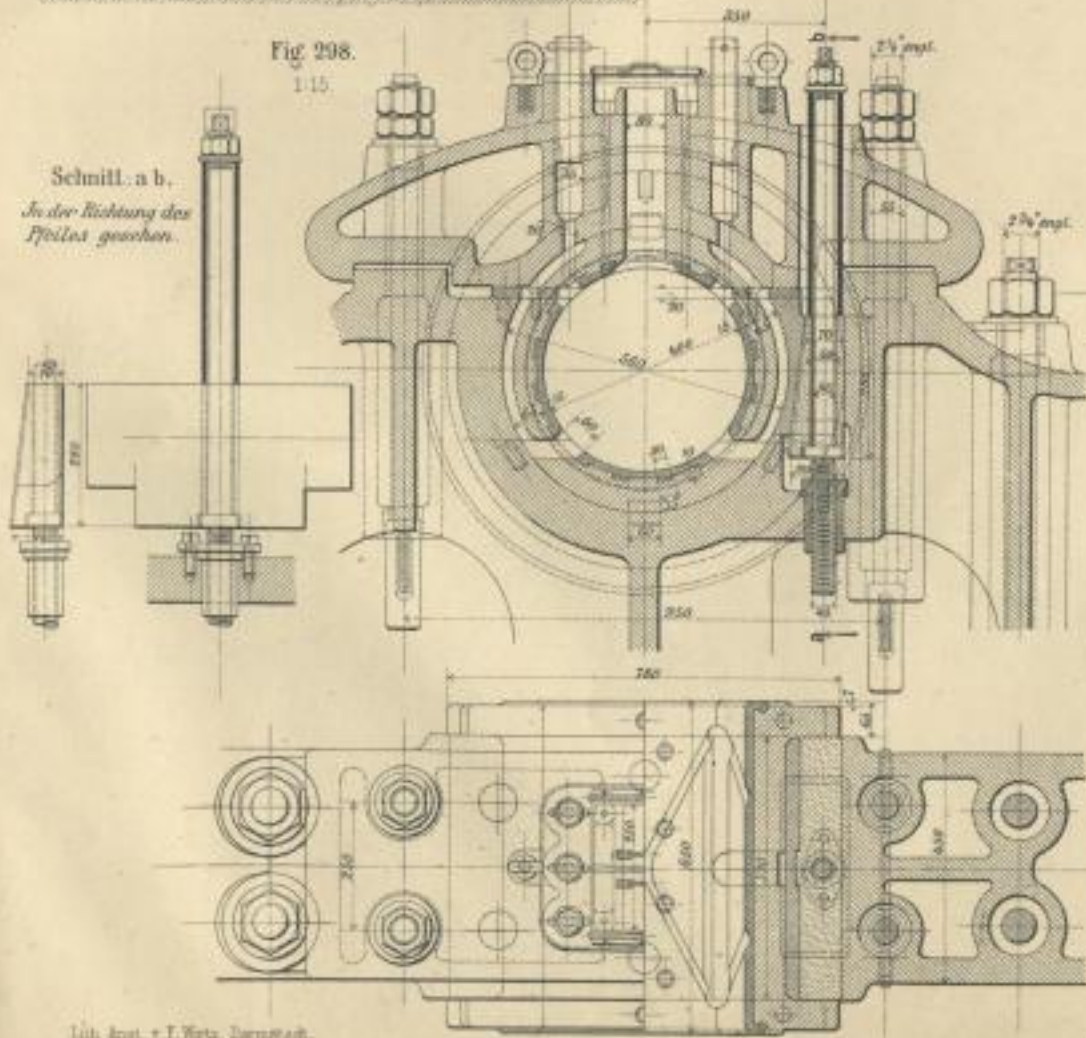

Fig. 277.
1:10

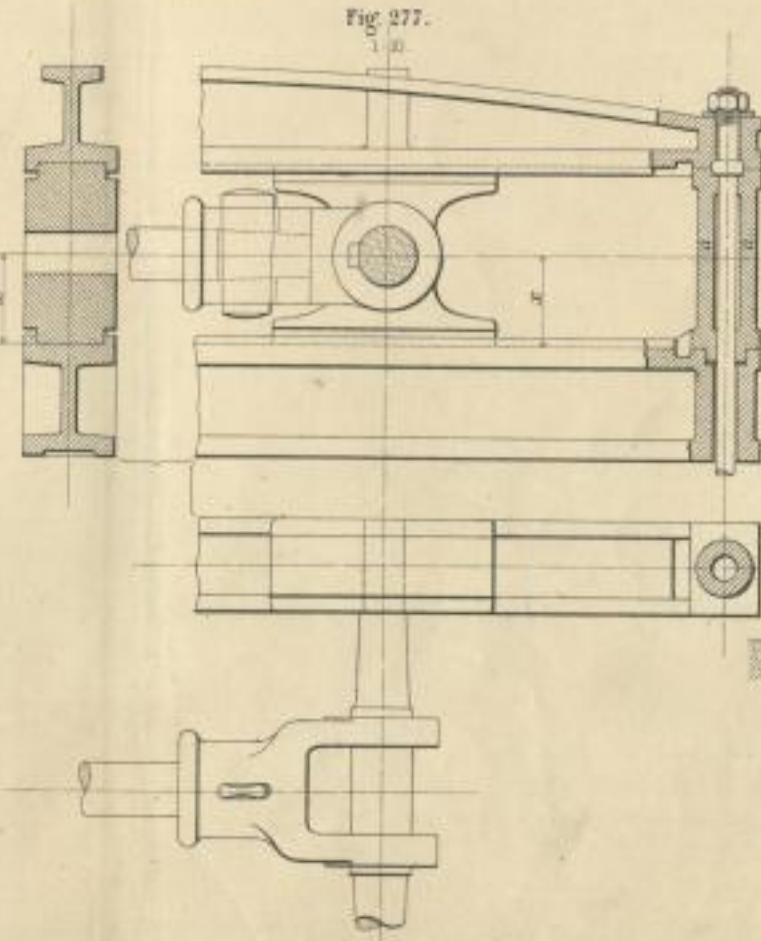
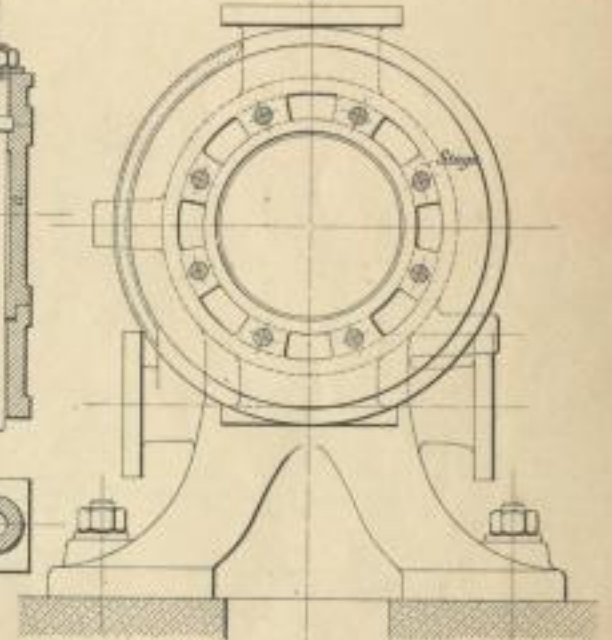

Fig. 265.
1:10



Lith. Anst. v. T. Wetz, Darmstadt.



SLUB

Wir führen Wissen.

<http://digital.slub-dresden.de/id446692875/76>



TECHNISCHE UNIVERSITÄT
CHEMNITZ

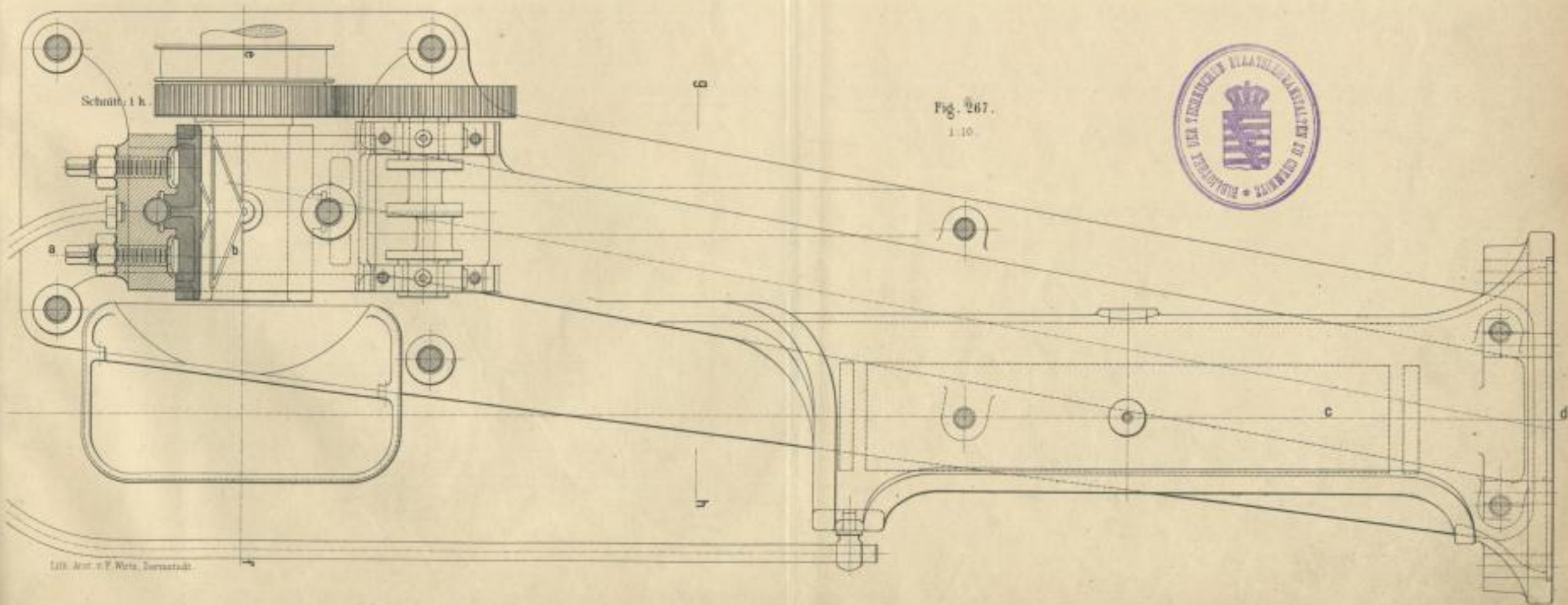
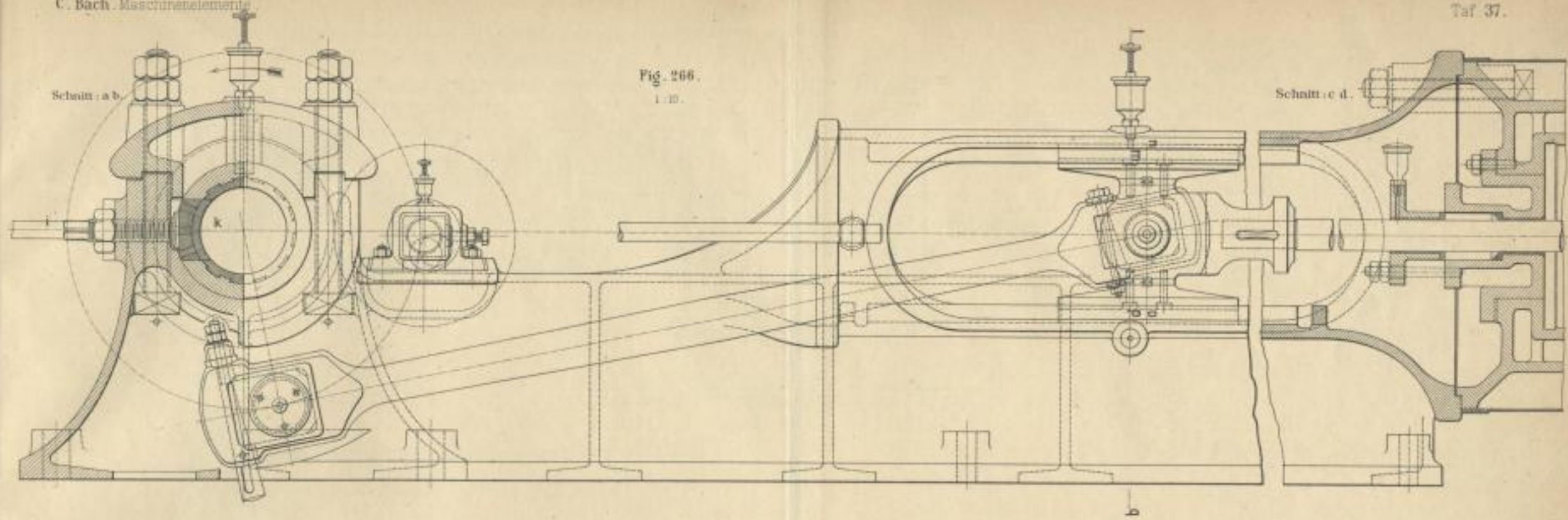

1898. Anst. v. F. Wetz, Chemnitz



SLUB

Wir führen Wissen.

<http://digital.slub-dresden.de/id446692875/78>



TECHNISCHE UNIVERSITÄT
CHEMNITZ

Fig. 268.

1:10

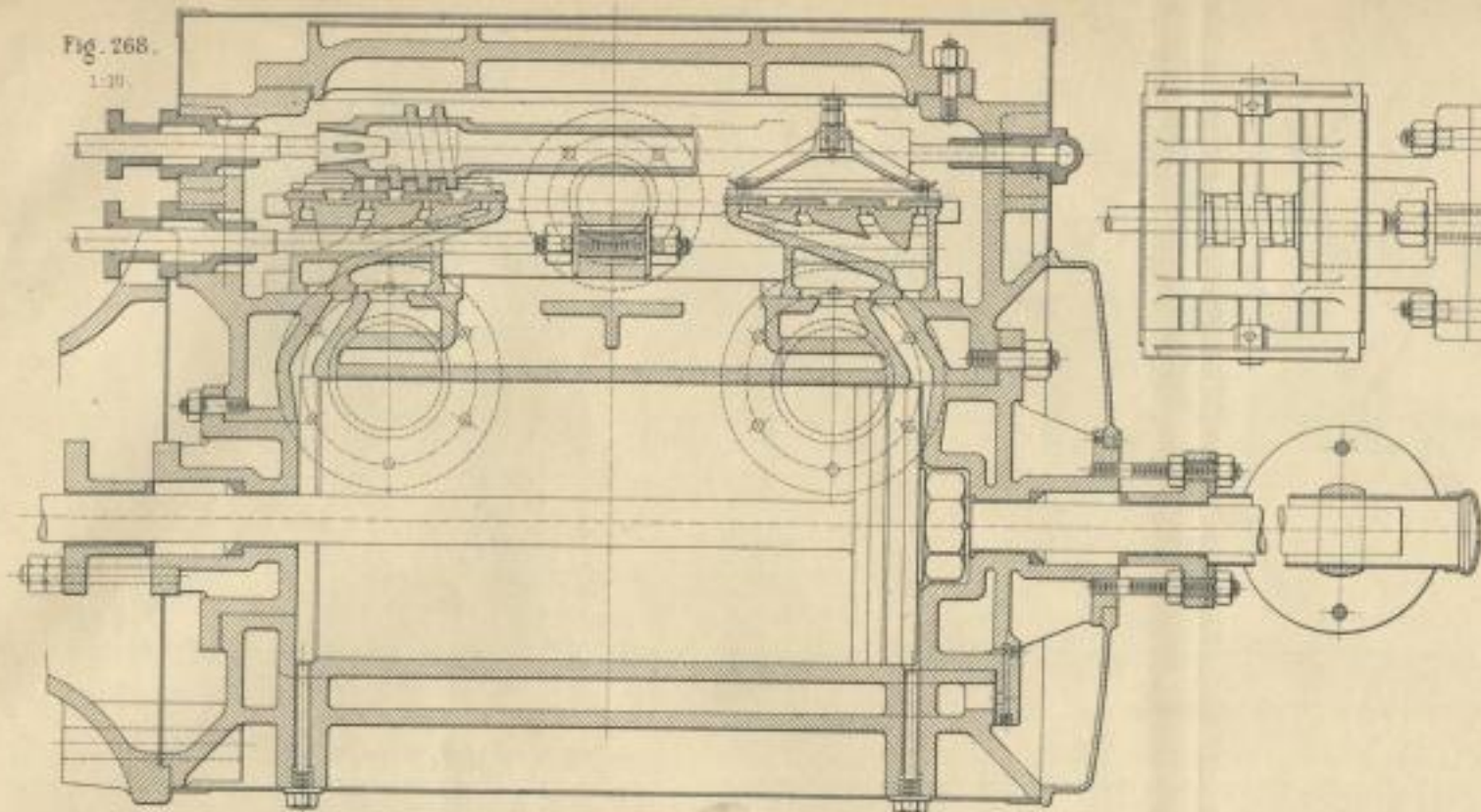

Fig. 269.

1:10

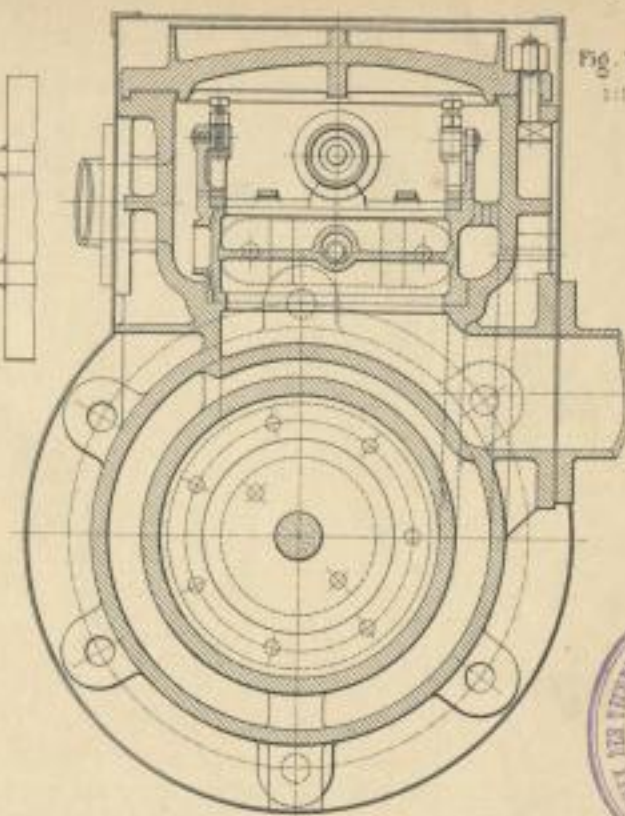

Fig. 270.

1:10

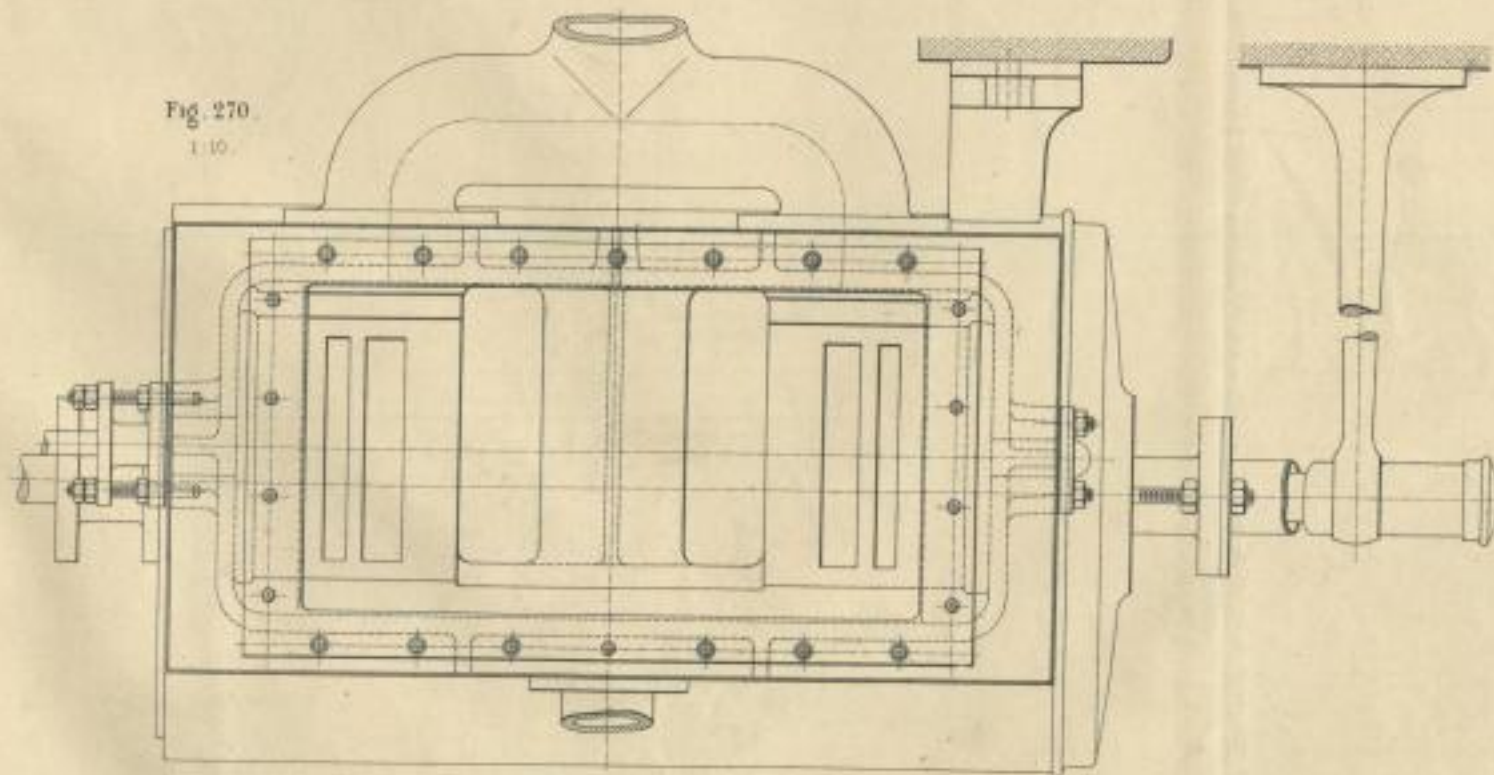
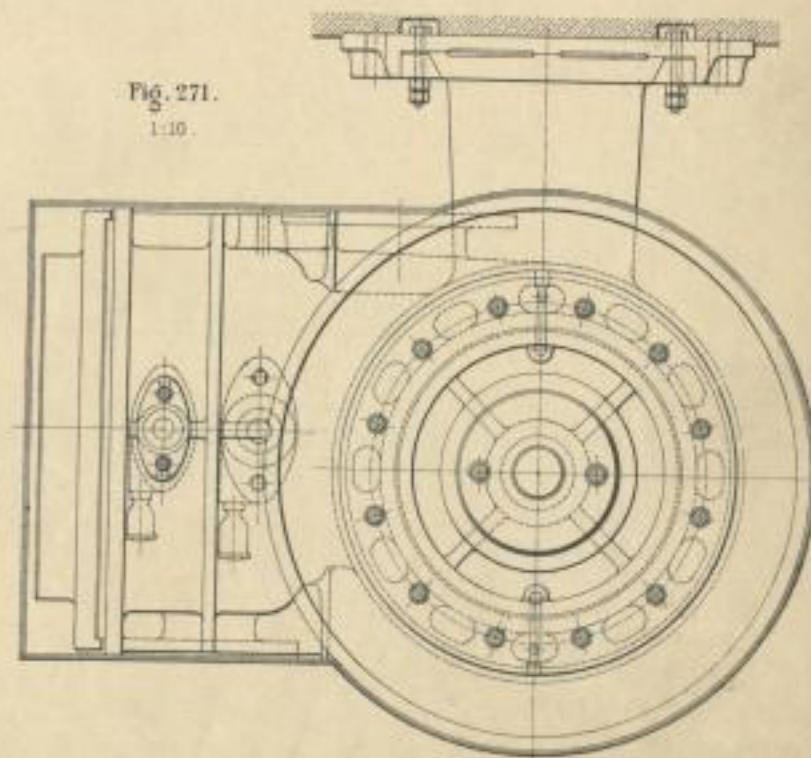

Fig. 271.

1:10



120. 2001. v. F. W. W. D. 2001. 2001.

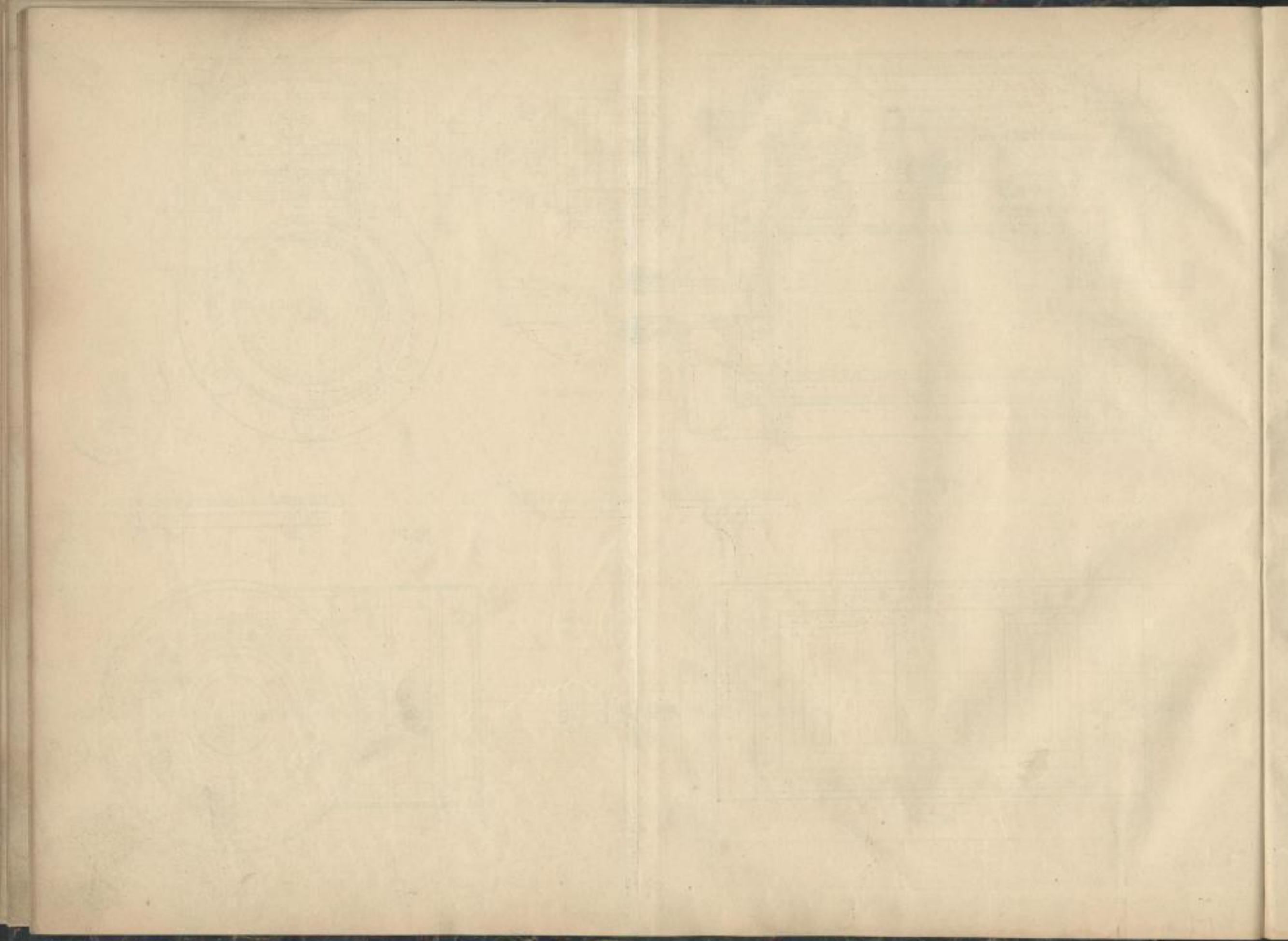
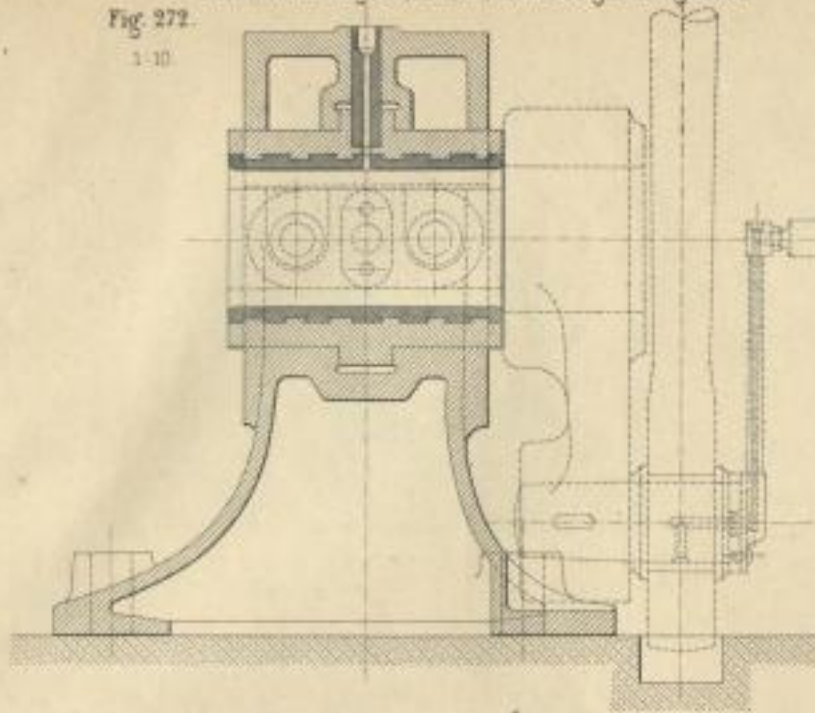
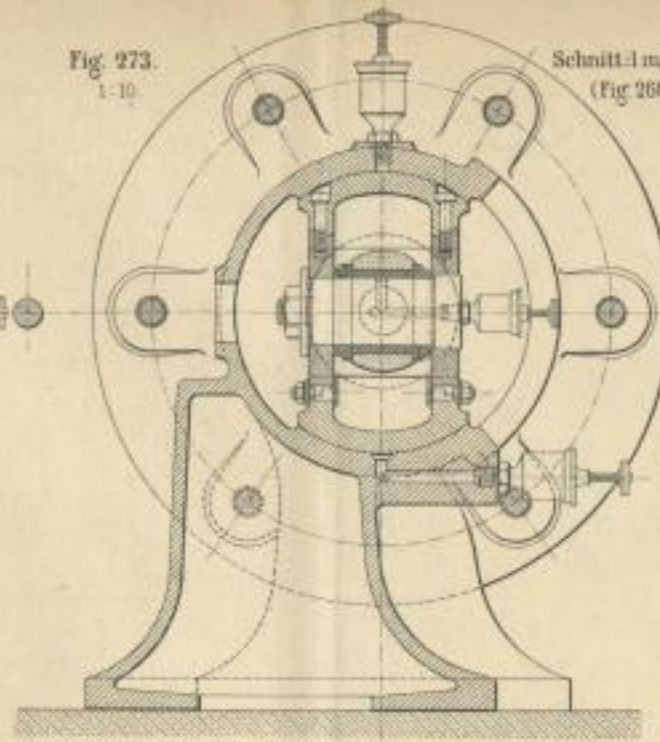

Fig. 272.
1:10.



Schnitt e f (Fig. 267, Taf. 37) ohne Trog am Lagerfuß.

Fig. 273.
1:10.



Schnitt l m, n o, p q.
(Fig. 286, Taf. 37).

Fig. 286.
1:5.

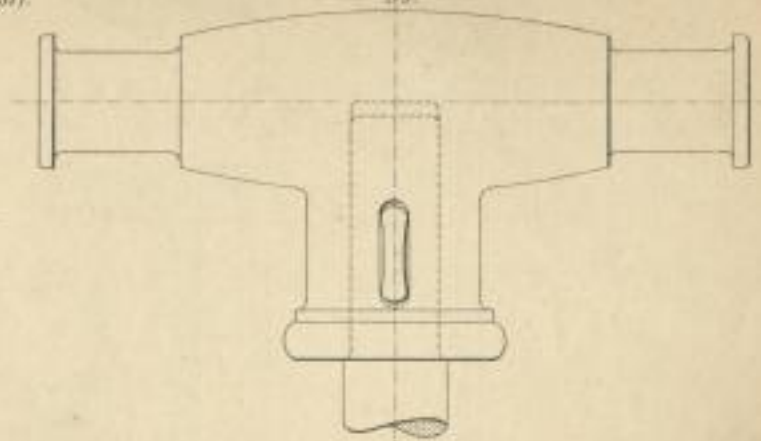
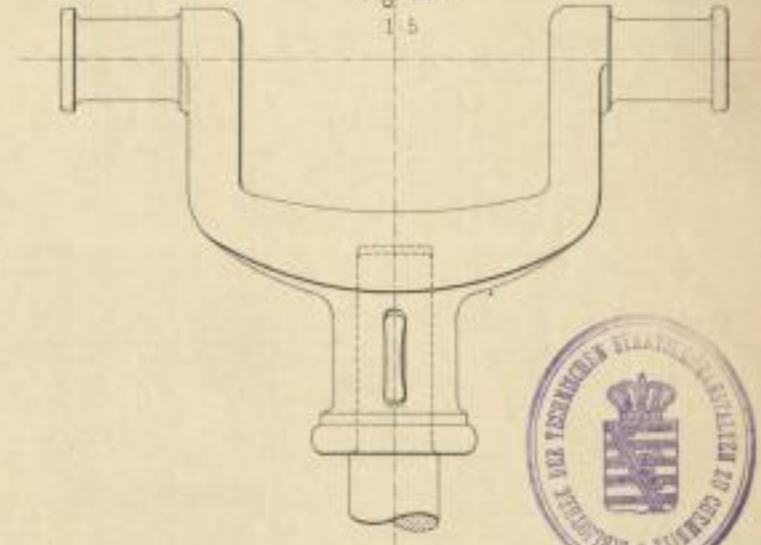
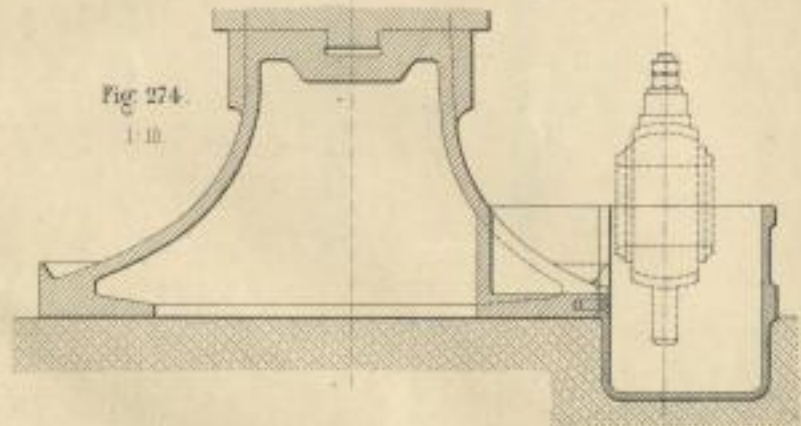

Fig. 287.
1:5.



Schnitt e f mit Trog am Lagerfuß.

Fig. 274.
1:10.



Schnitt g h (Fig. 267, Taf. 37).

Fig. 275.
1:10.

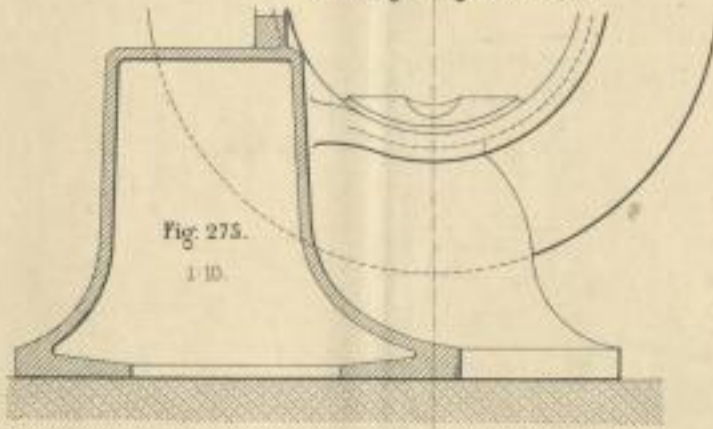

Fig. 281.
1:5.

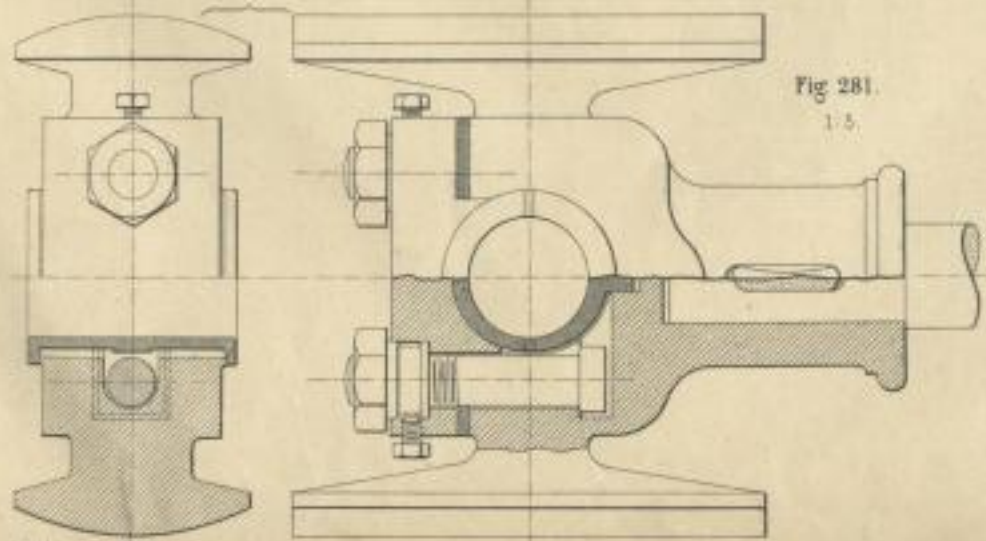
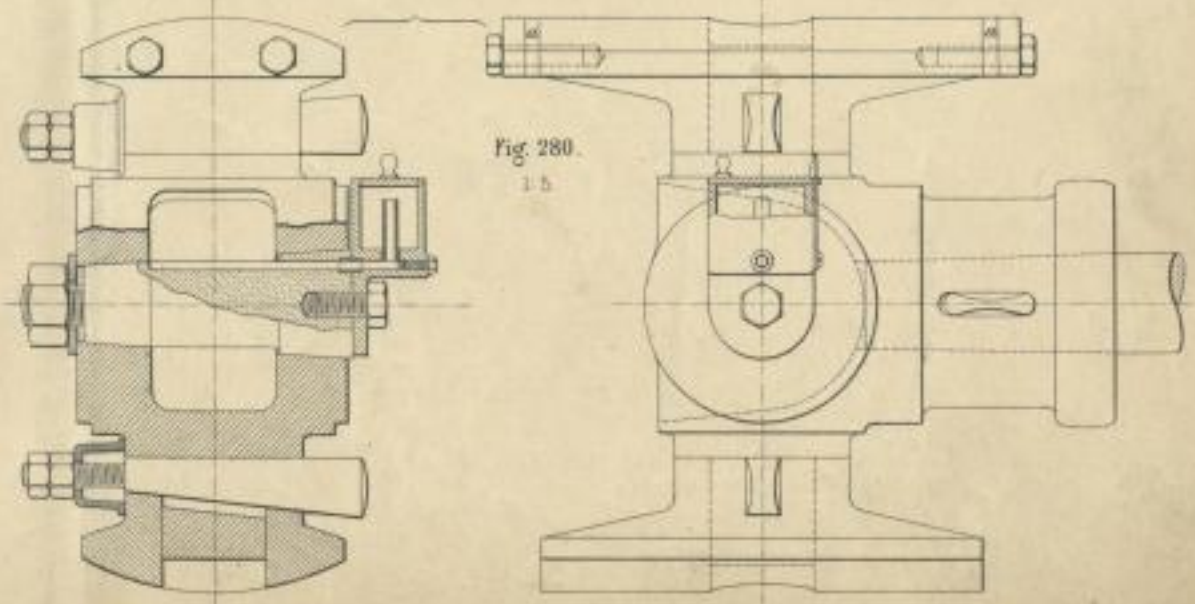

Fig. 280.
1:5.



Lith. Anst. v. F. W. Neumann, Neudamm.



SLUB

Wir führen Wissen.

<http://digital.slub-dresden.de/id446692875/82>



TECHNISCHE UNIVERSITÄT
CHEMNITZ

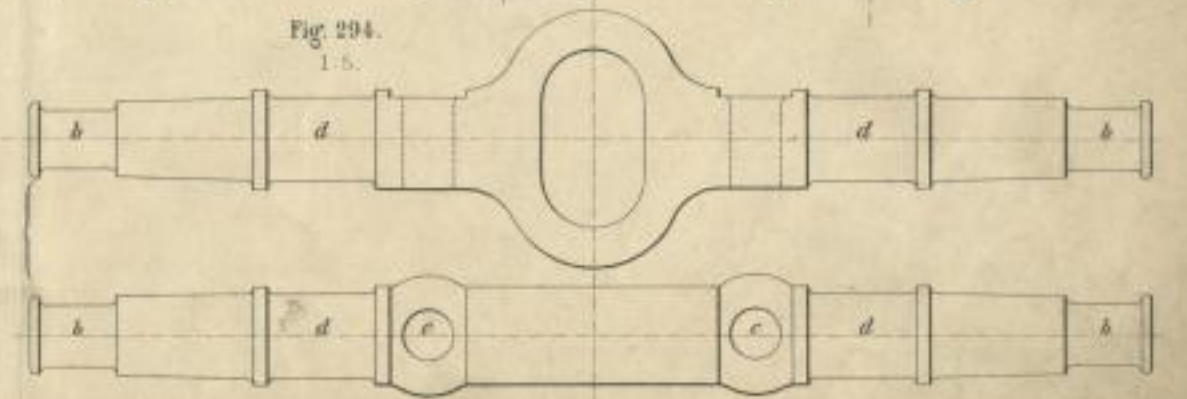
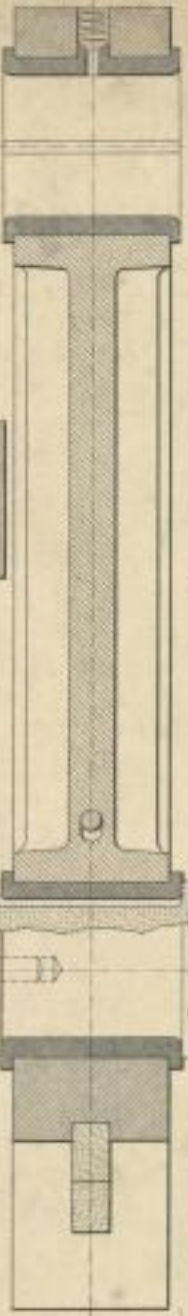
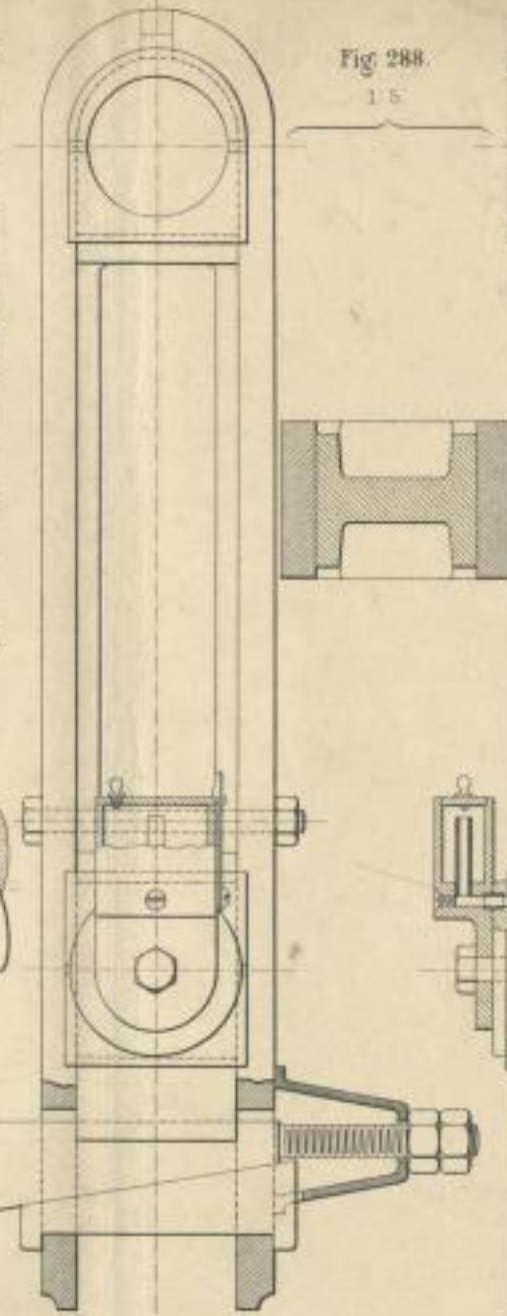
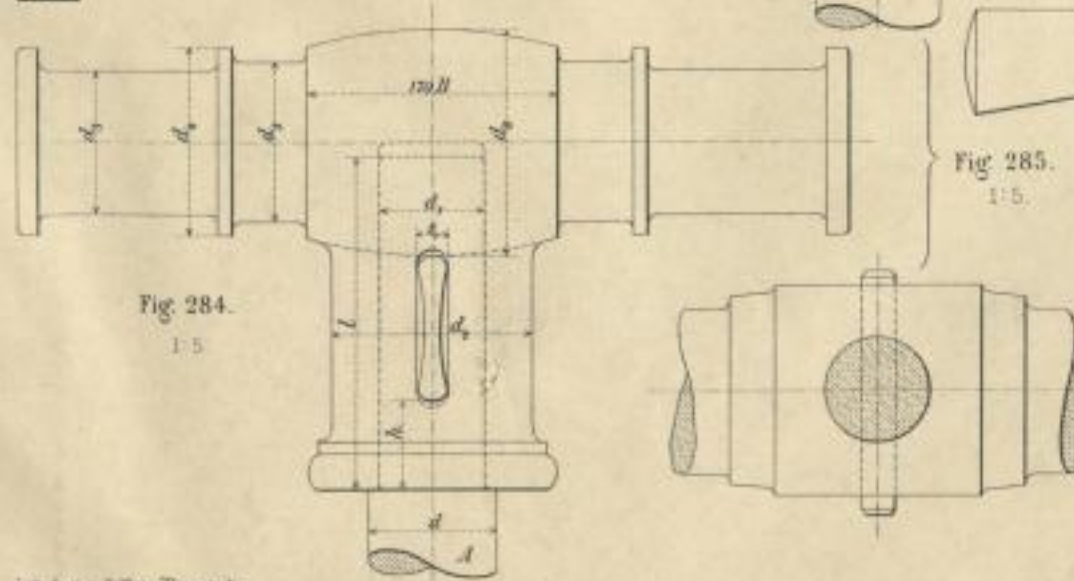
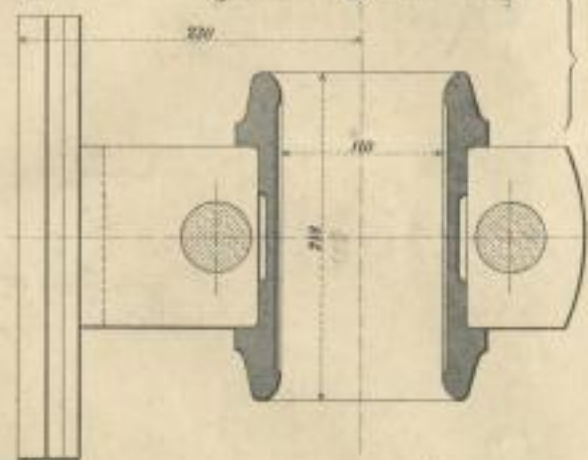
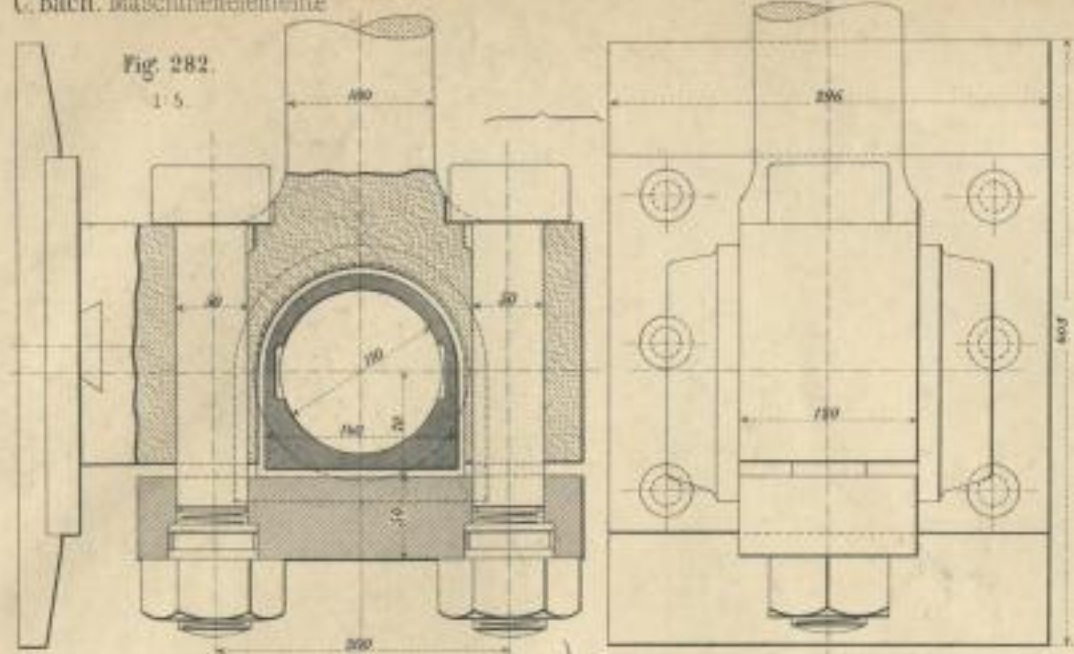

120. Aut. v. F. Witt, Dresden.



SLUB

Wir führen Wissen.

<http://digital.slub-dresden.de/id446692875/84>



TECHNISCHE UNIVERSITÄT
CHEMNITZ

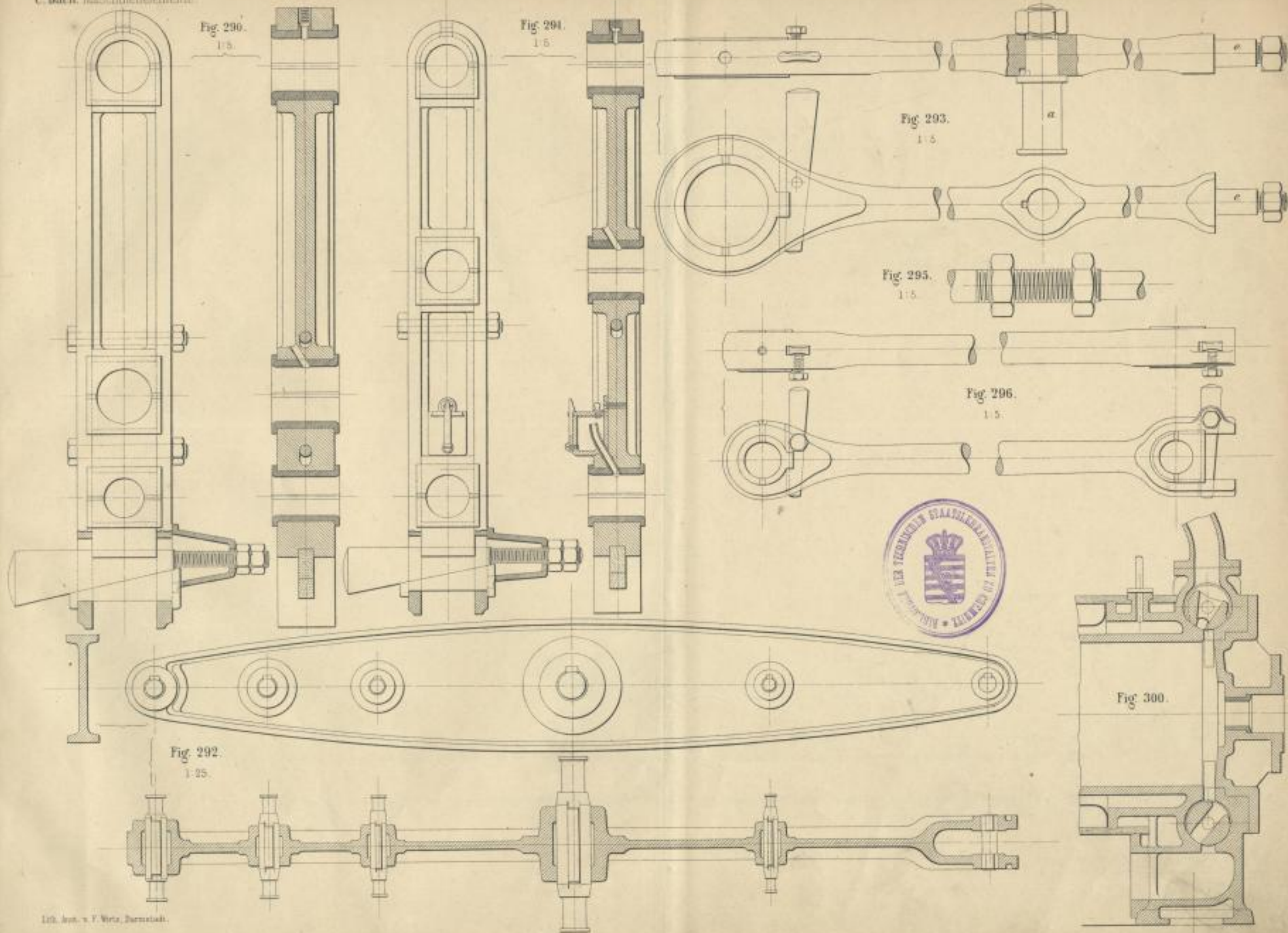

119. Aut. v. F. Wirtz, Eisenstahl.

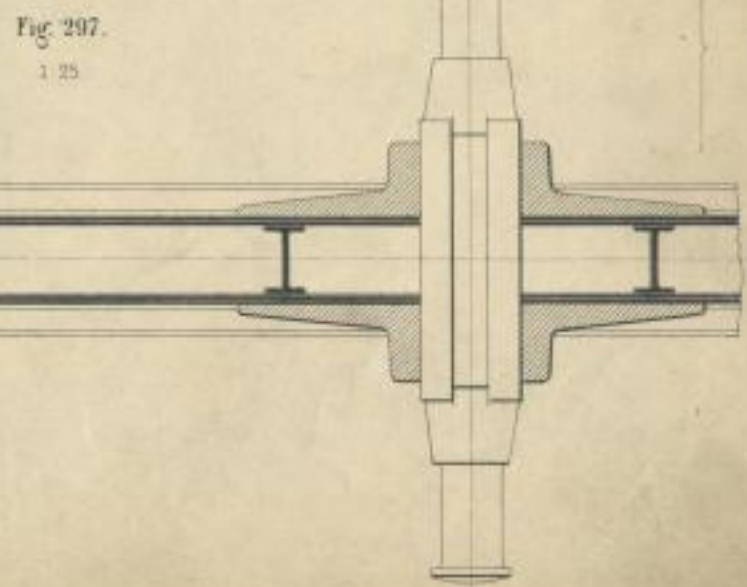
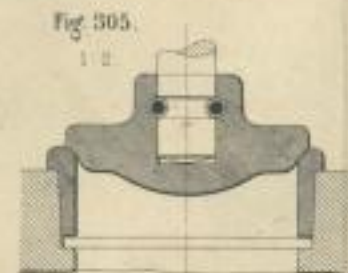
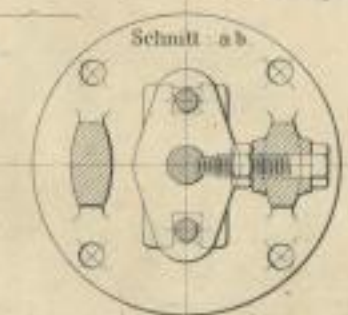
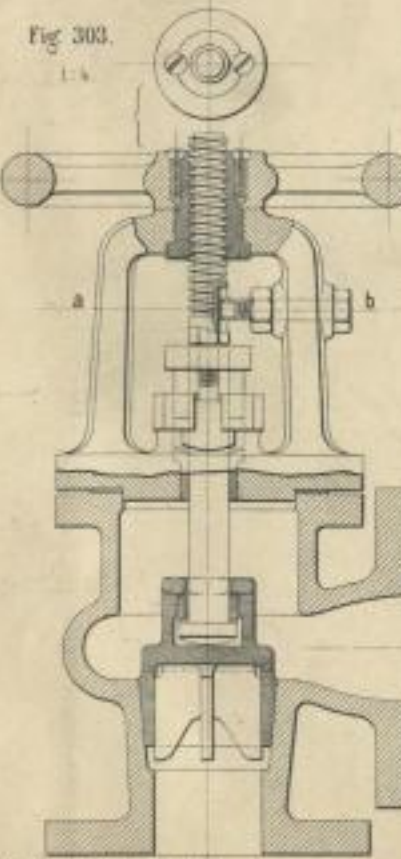
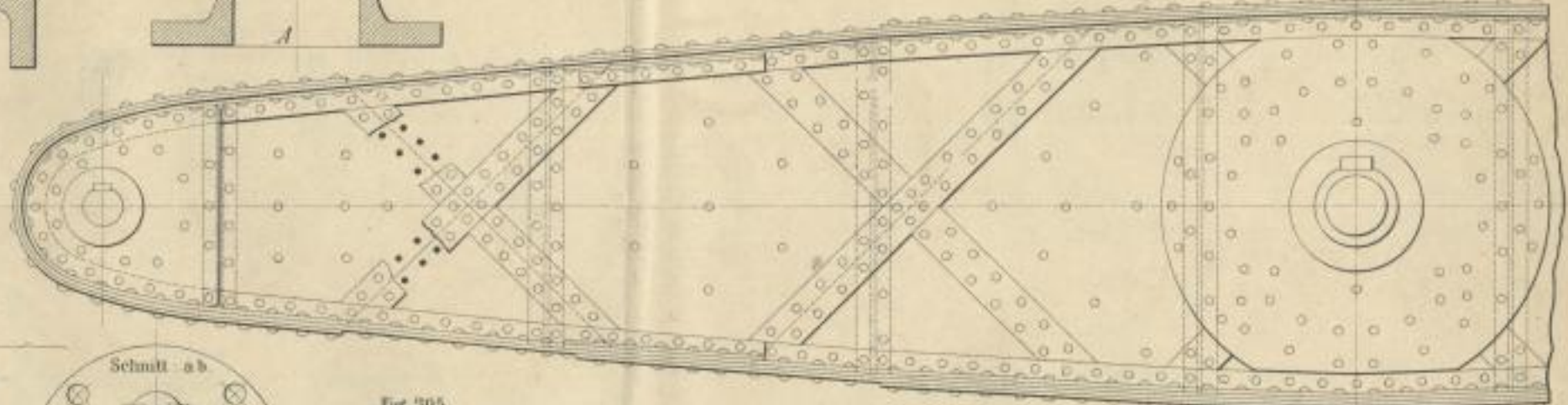
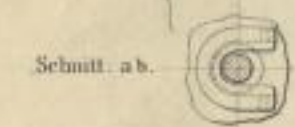
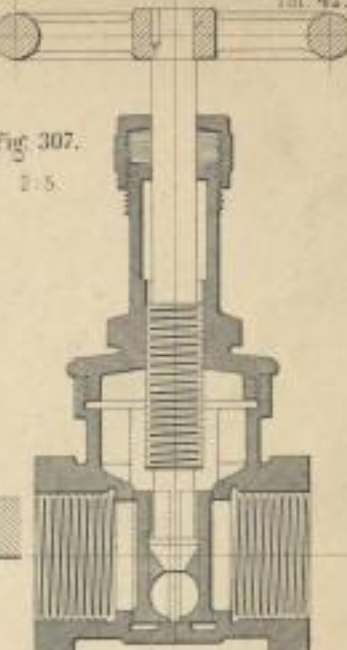
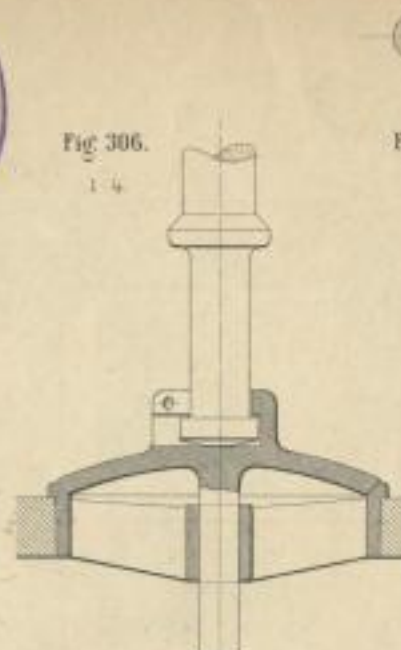
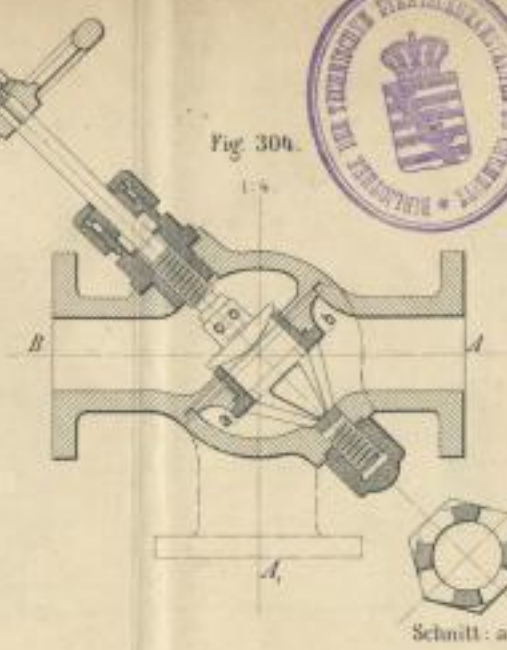
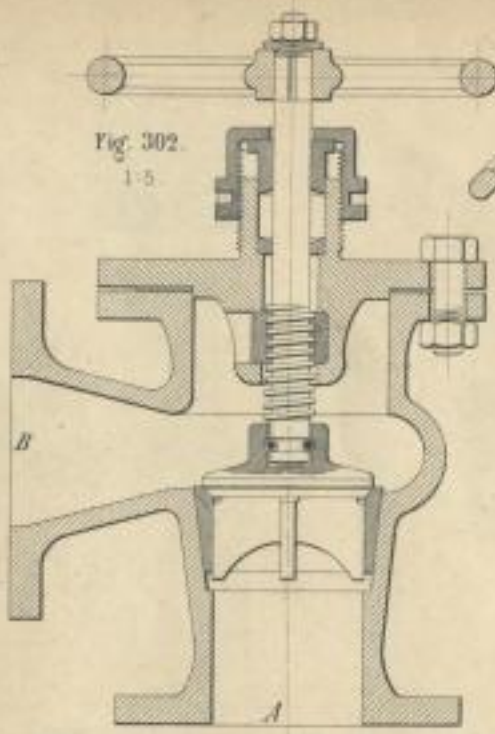
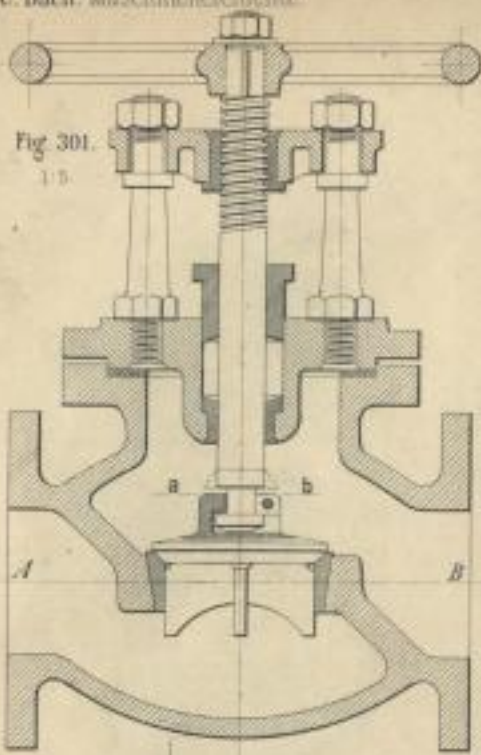

Lith. Anst. v. F. Wirtz, Darmstadt.

Fig. 309.
1:2.

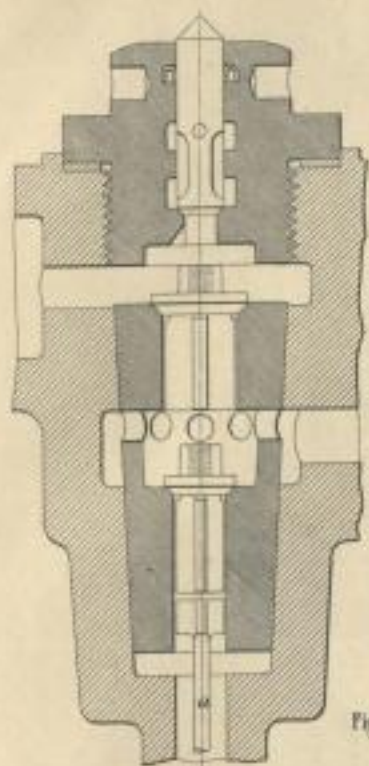
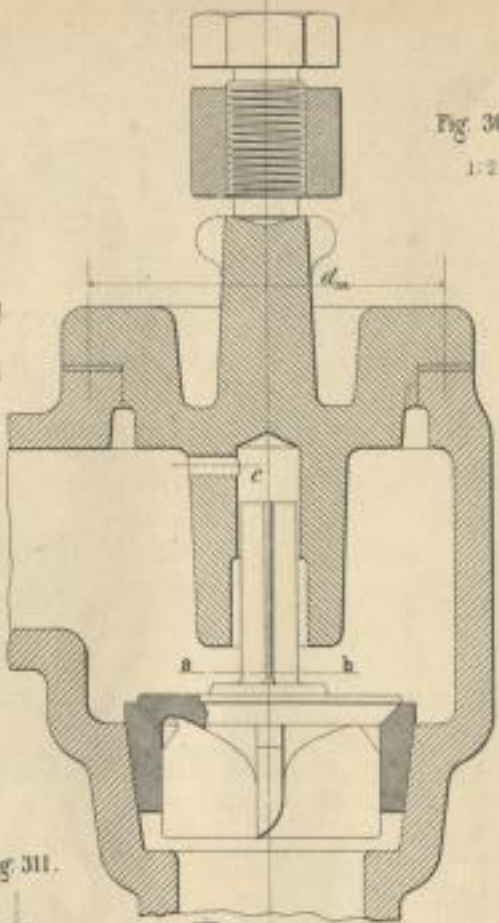

Fig. 308.
1:2.



Schnitt: a-b.

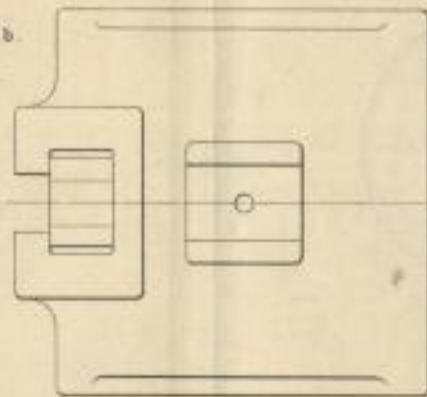

Fig. 312.
1:5.

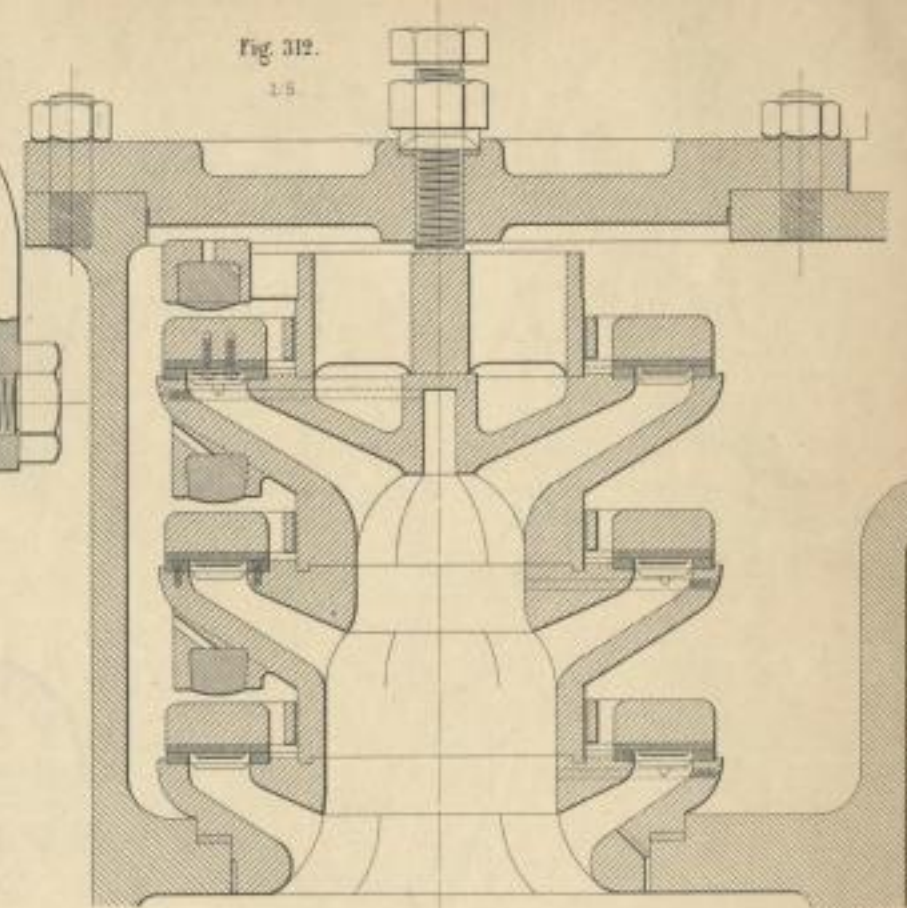

Fig. 311.

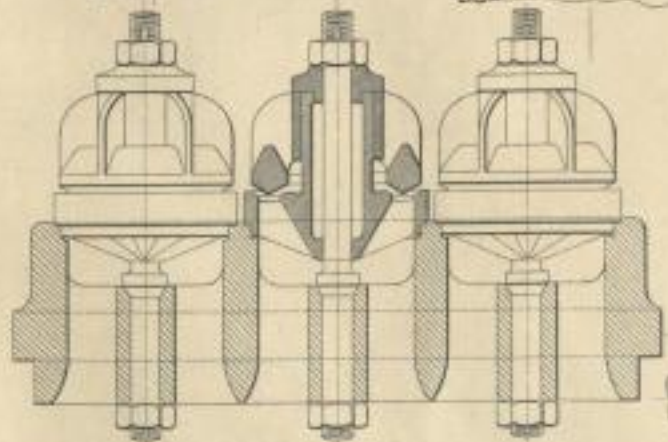
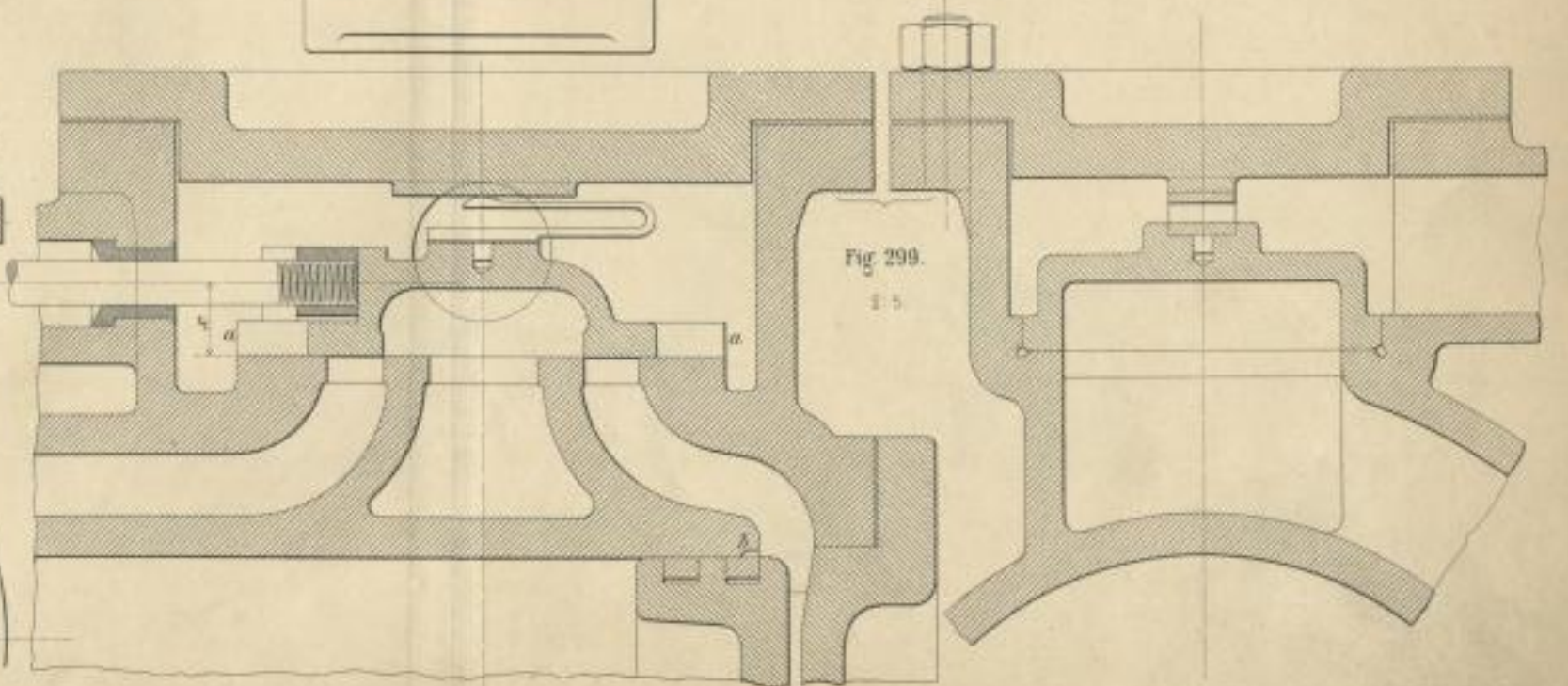

Fig. 290.
1:5.



18th. Anst. v. T. Witz, Darmstadt.



Fig. 310.

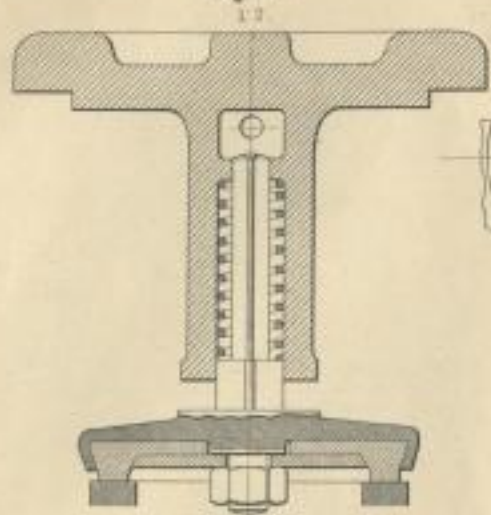

Fig. 314.



Schnitt: a b.

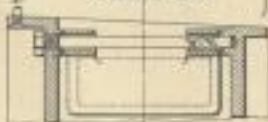
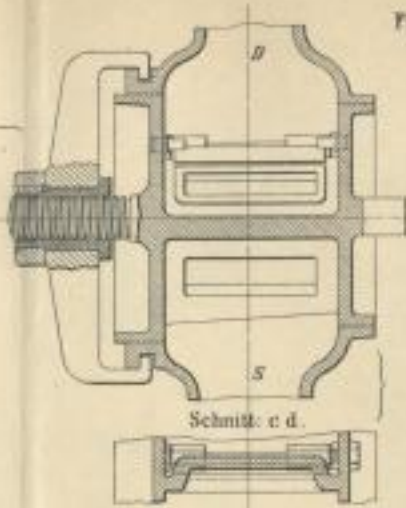

Fig. 316.



Schnitt: c d.

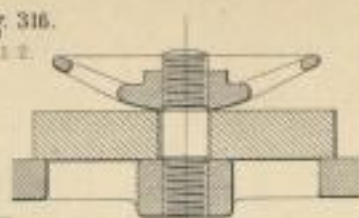

Fig. 315.

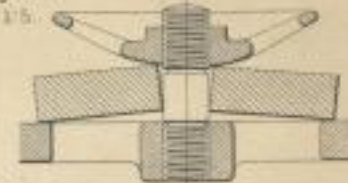

Fig. 317.

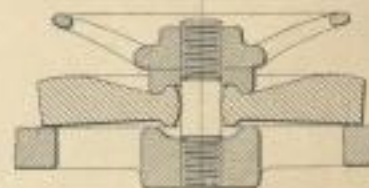

Fig. 318.

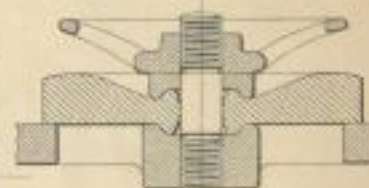

Fig. 319.

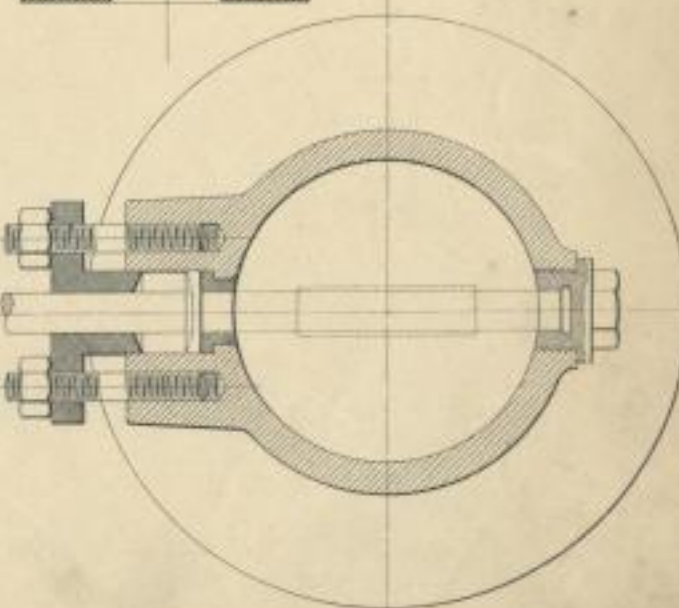

Fig. 325.

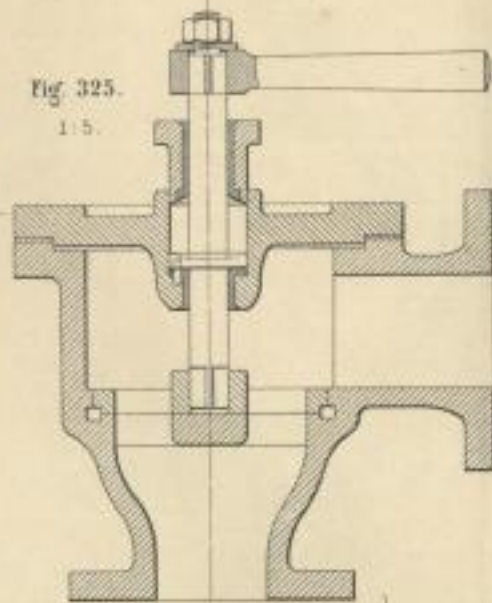

Fig. 321.

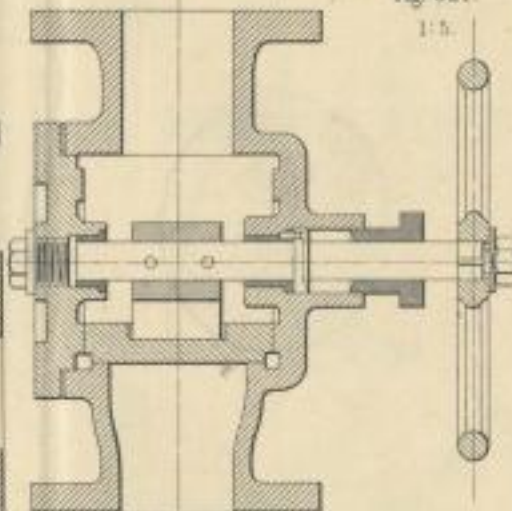

Fig. 313.

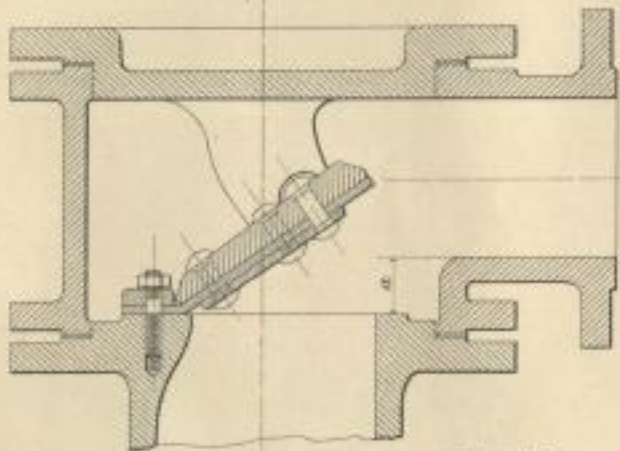



Fig. 320.
1:5.

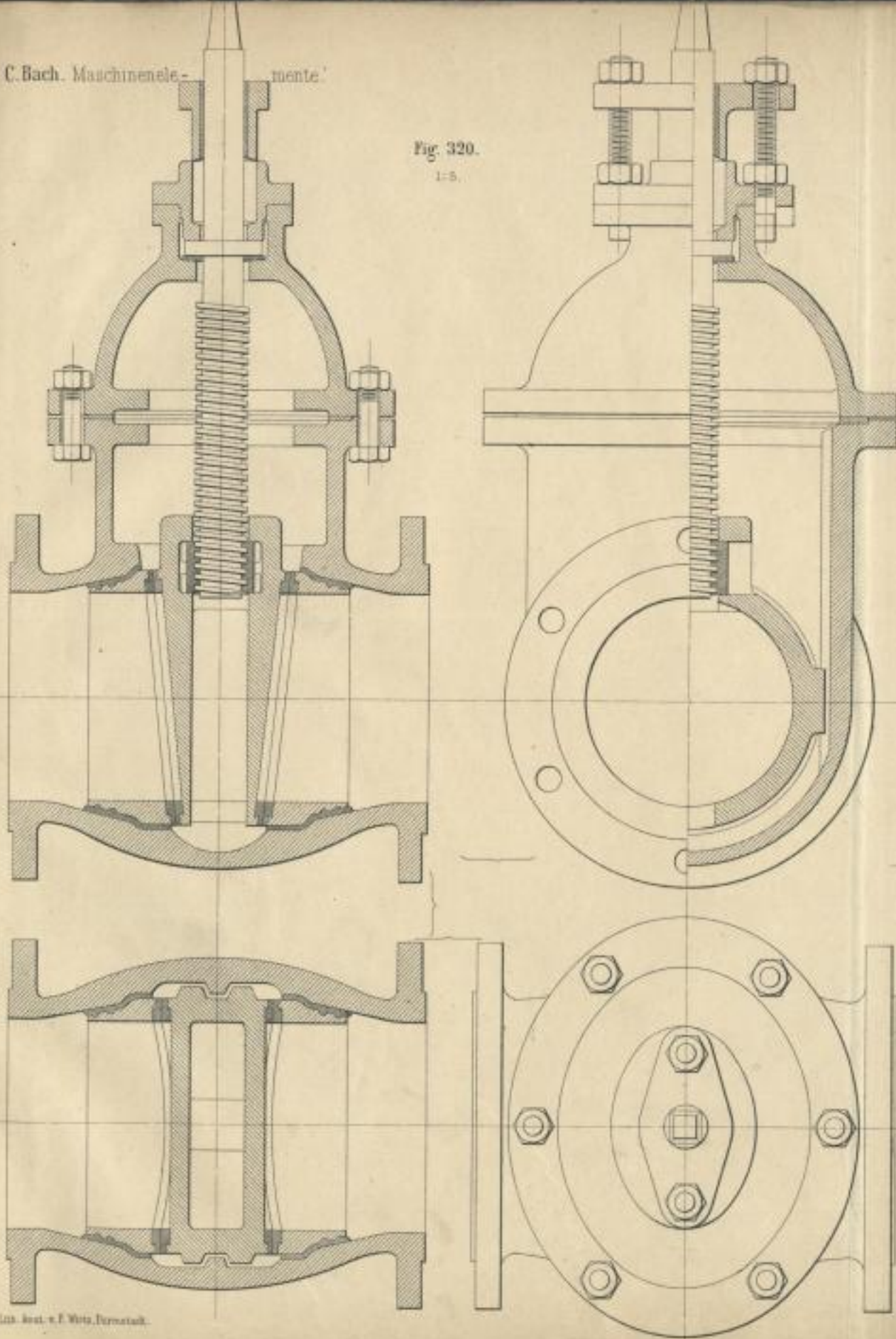

Fig. 328.
2:5.

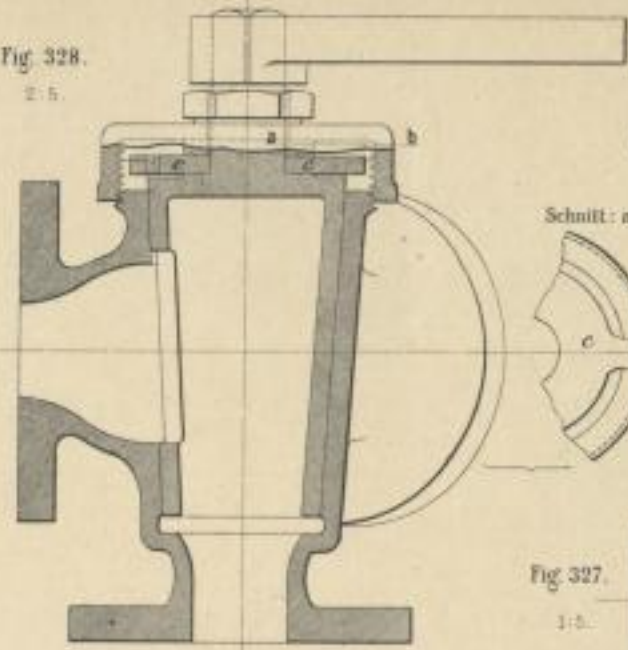

Fig. 326.
2:5.

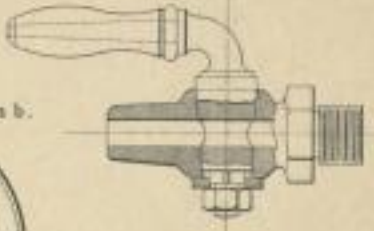

Fig. 327.
1:5.

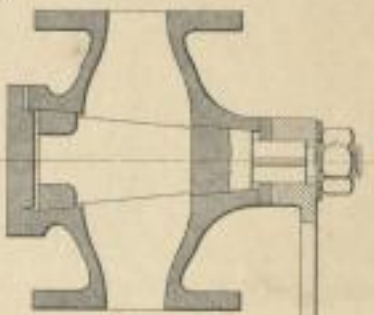

Fig. 324.
1:5.

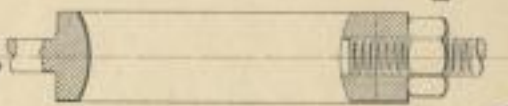
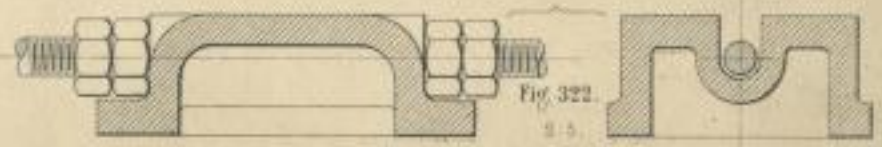

Fig. 323.
2:5.



Fig. 322.
2:5.



Lit. Anst. v. F. Witz, Darmstadt.

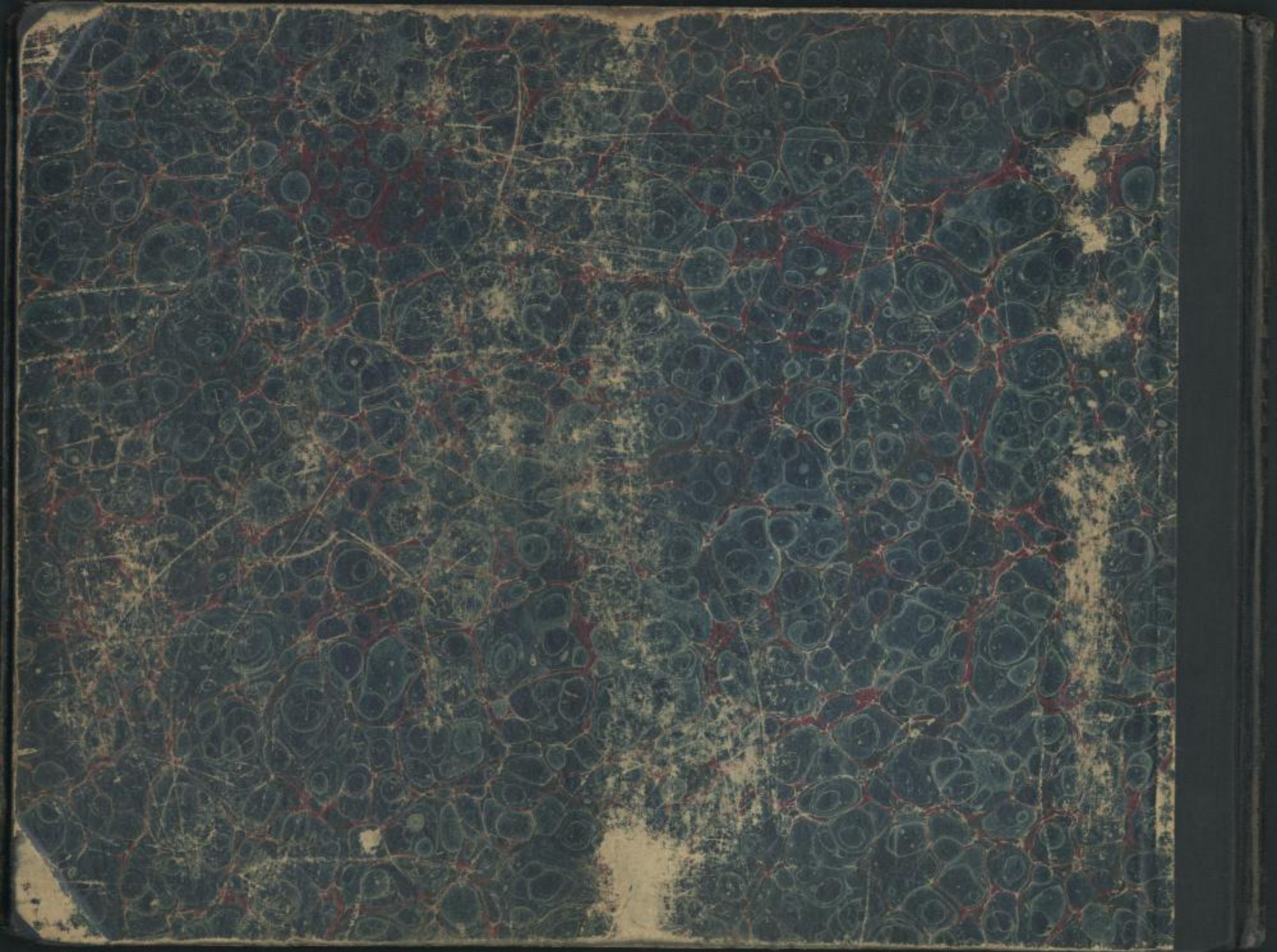

SLUB

Wir führen Wissen.

<http://digital.slub-dresden.de/id446692875/96>



TECHNISCHE UNIVERSITÄT
CHEMNITZ