

Figuren-Tafeln

zum

Leitfaden für die ersten Übungen

im Zeichnen und Konstruiren von Maschinentheilen

für die

Technischen Staatslehranstalten in Chemnitz

bearbeitet von

H. Berndt.



1899.

H

2

755



SLUB

Wir führen Wissen.



TECHNISCHE UNIVERSITÄT
CHEMNITZ

H
255
Atlas

2. Jg. X



SLUB

Wir führen Wissen.



TECHNISCHE UNIVERSITÄT
CHEMNITZ

Figuren-Tafeln

zum

Leitsaden für die ersten Uebungen

im Zeichnen und Konstruiren von Maschinentheilen

für die

Technischen Staatslehranstalten in Chemnitz

bearbeitet von

N. Berndt.



1899.

(Als Manuskript gedruckt.)

Technische Universität
Chemnitz
Universitätsbibliothek

WA

H 755-2



Vorbemerkung zu den Figuren-Tafeln.

Die sämtlichen auf den nachstehenden Tafeln enthaltenen Figuren sind als Darstellung der in Blei gezeichneten Entwürfe zu betrachten. Sie enthalten daher absichtlich manche Unvollkommenheiten, die die Bleizeichnungen rasch arbeitender Ingenieure zu enthalten pflegen und die erst beim Ausziehen in Wegfall gebracht werden. So sind beispielsweise absichtlich viele Linien durchgezogen, die beim Ausziehen dann gestrichelt werden, auch sind absichtlich, wie sich beim anhaltend raschen Arbeiten von selbst ergibt und als praktisch erweist, viele Linien länger gezogen, als sie gebraucht werden u. s. w.

Uebersetzung in die deutsche Sprache

Die Geschichte der Welt
von der Schöpfung bis zur
gegenwärtigen Zeit
in 12 Bänden
von
Johann Friedrich Meißner
Lehrer an der
Hochschule zu
Göttingen
1804

Fig 1.
 $\frac{1}{5}$ nat. Größe

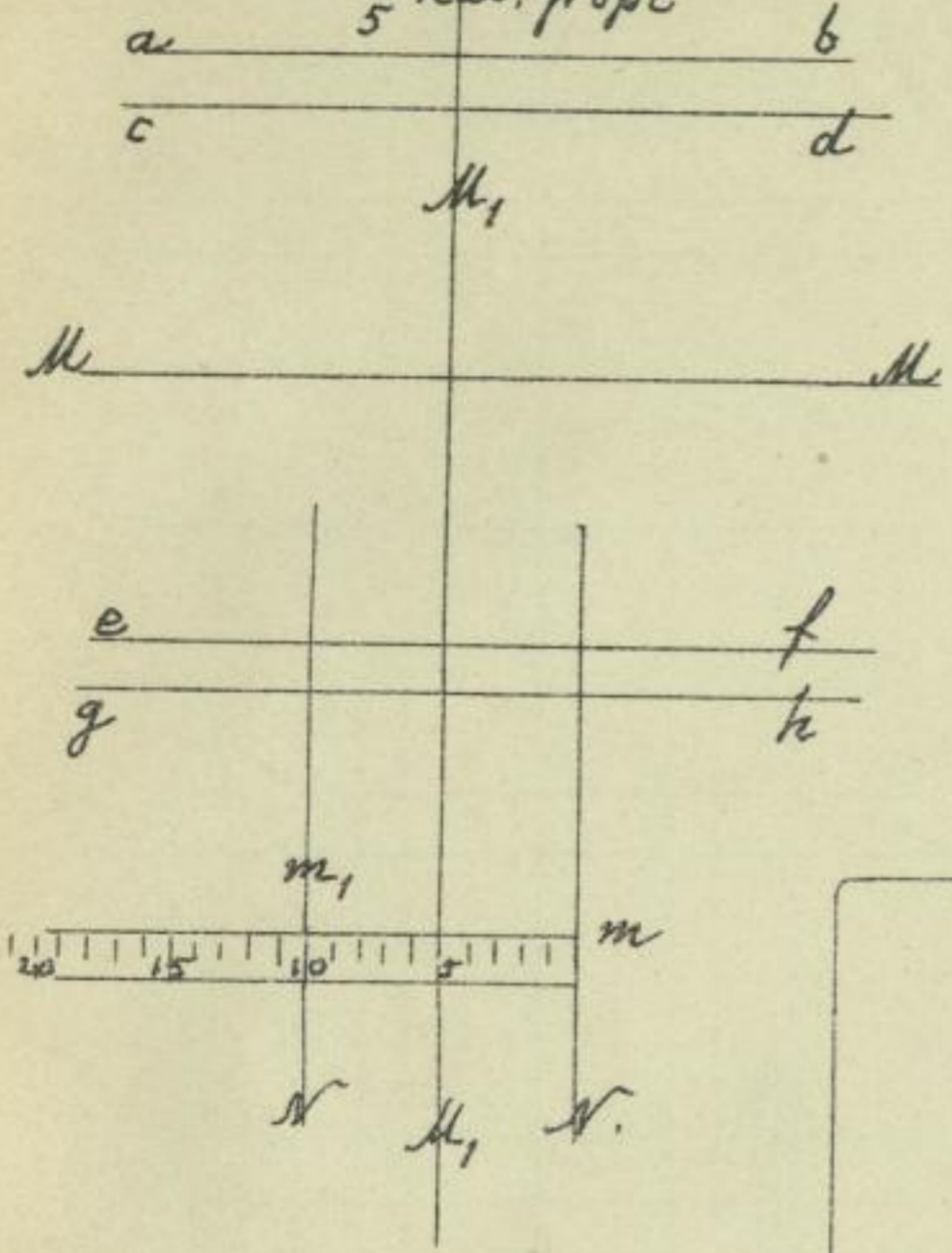

Fig 2
 $\frac{1}{5}$ nat. Gr.

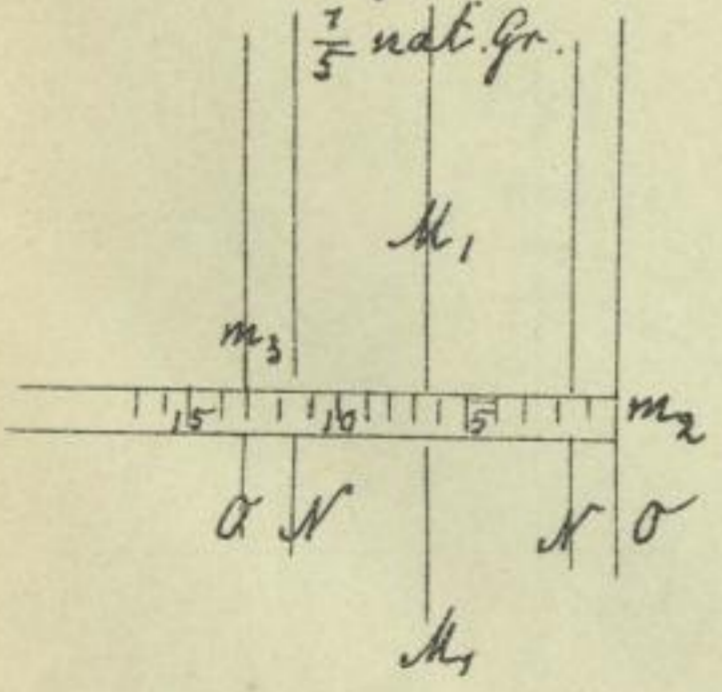

Fig 3
 $\frac{1}{5}$ nat. Gr.

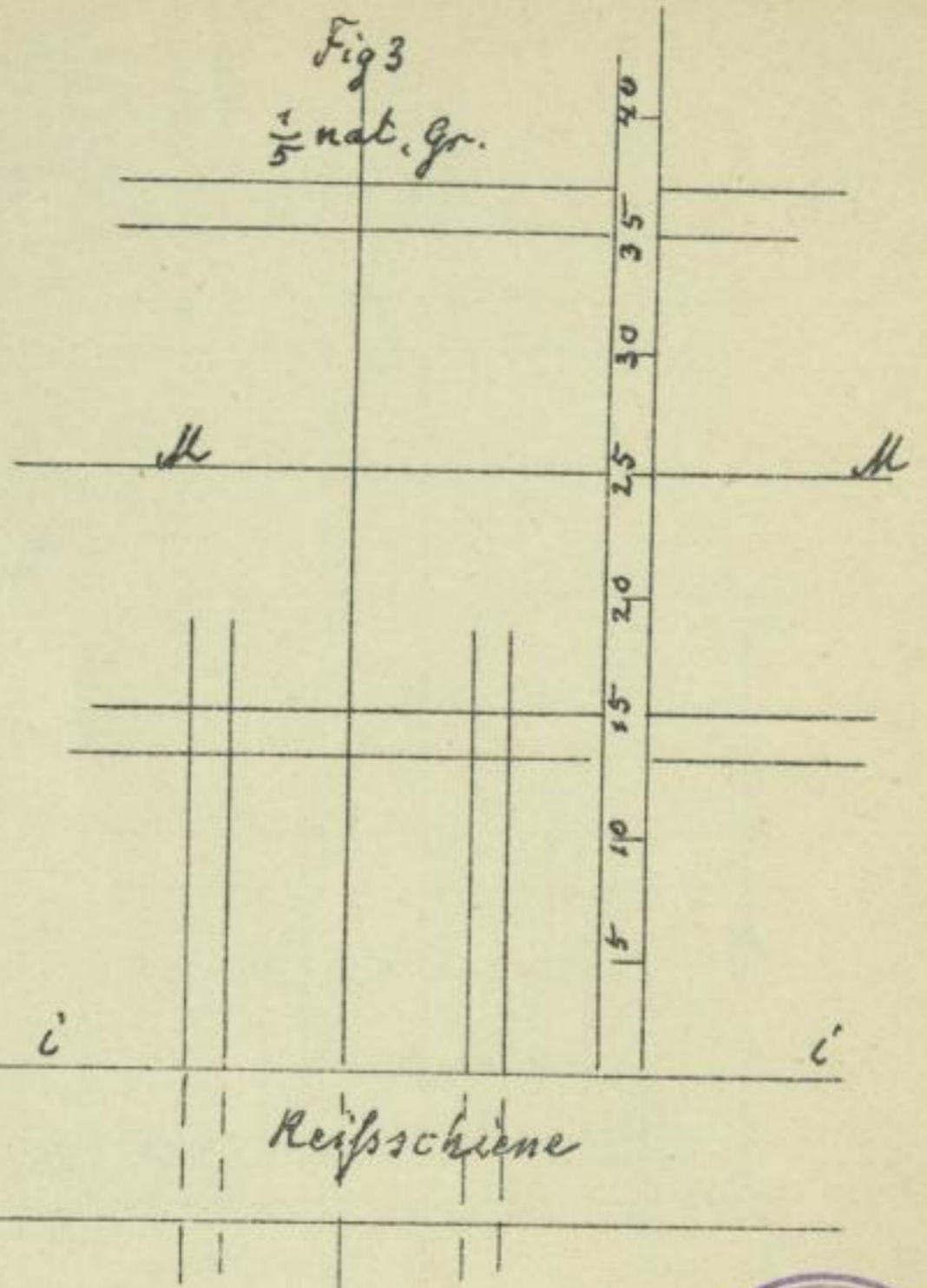

Fig 4
 $\frac{1}{5}$ nat. Gr.

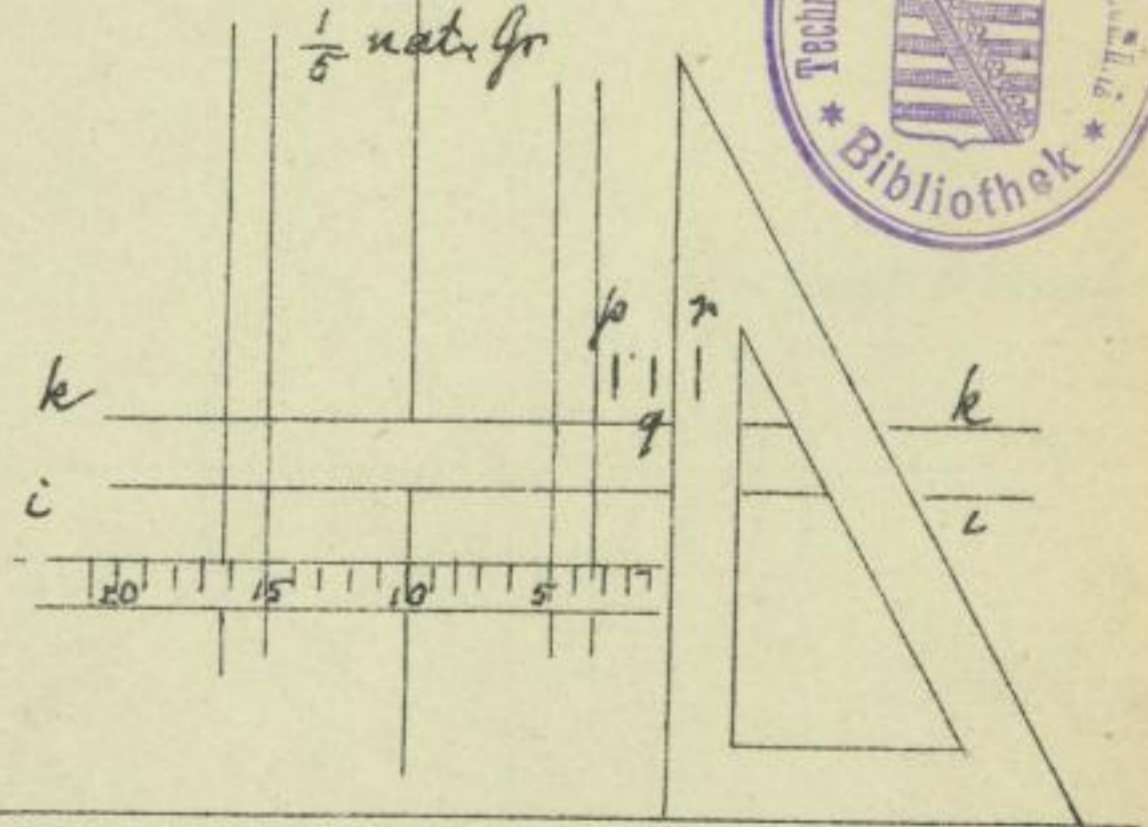



Fig 5
 $\frac{1}{5}$ nat. Gr.

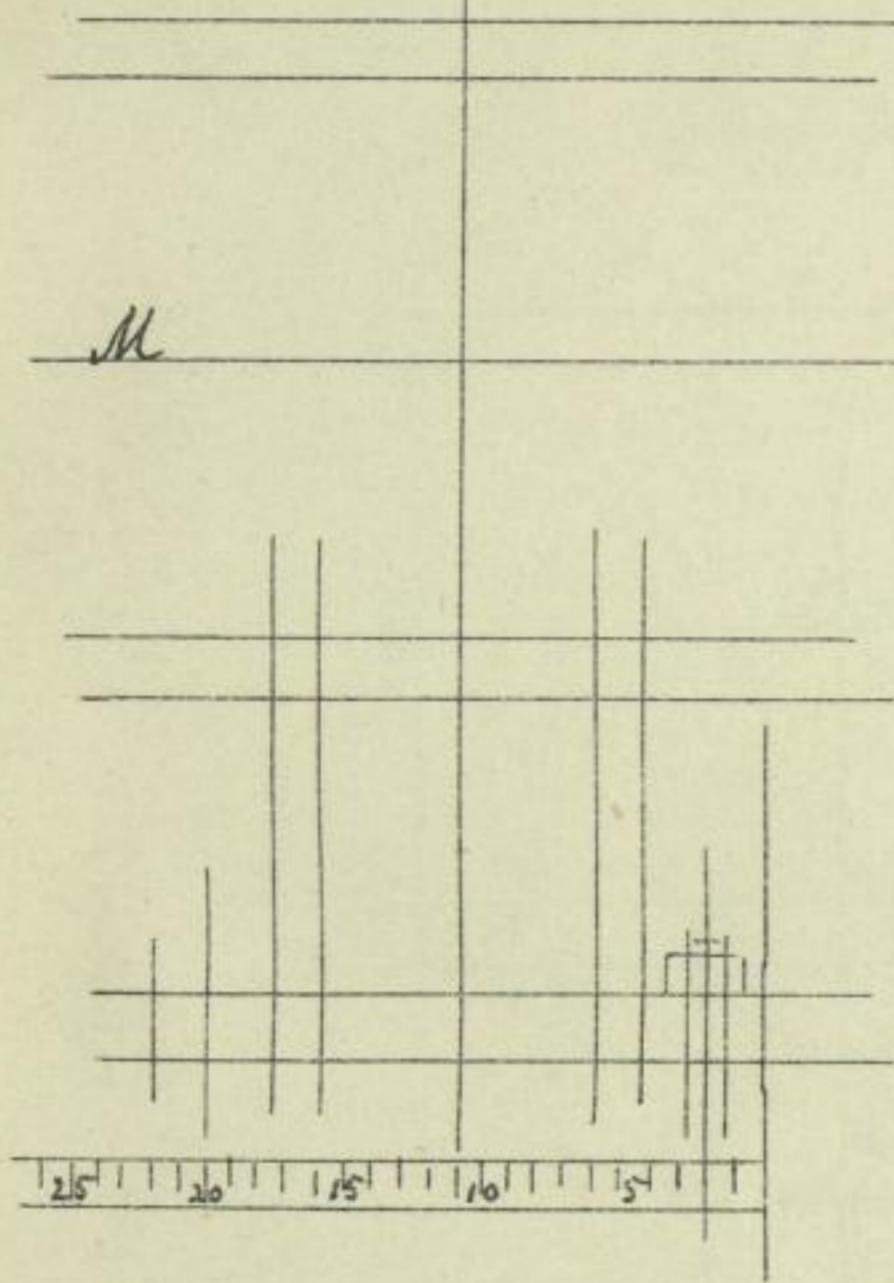

Fig 7

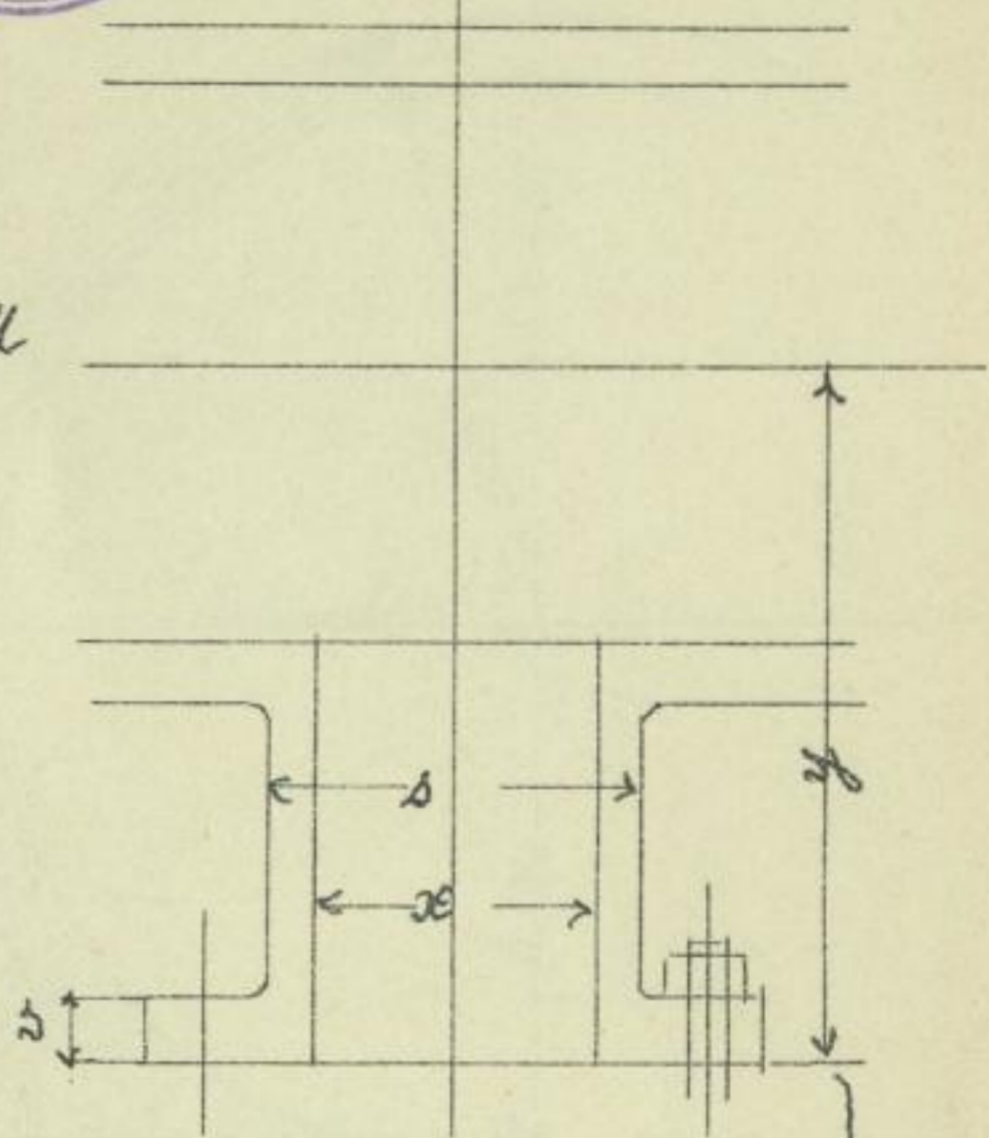

Fig 7
 $\frac{1}{5}$ nat. Gr.

Fig 6
 $\frac{1}{5}$ nat. Gr.

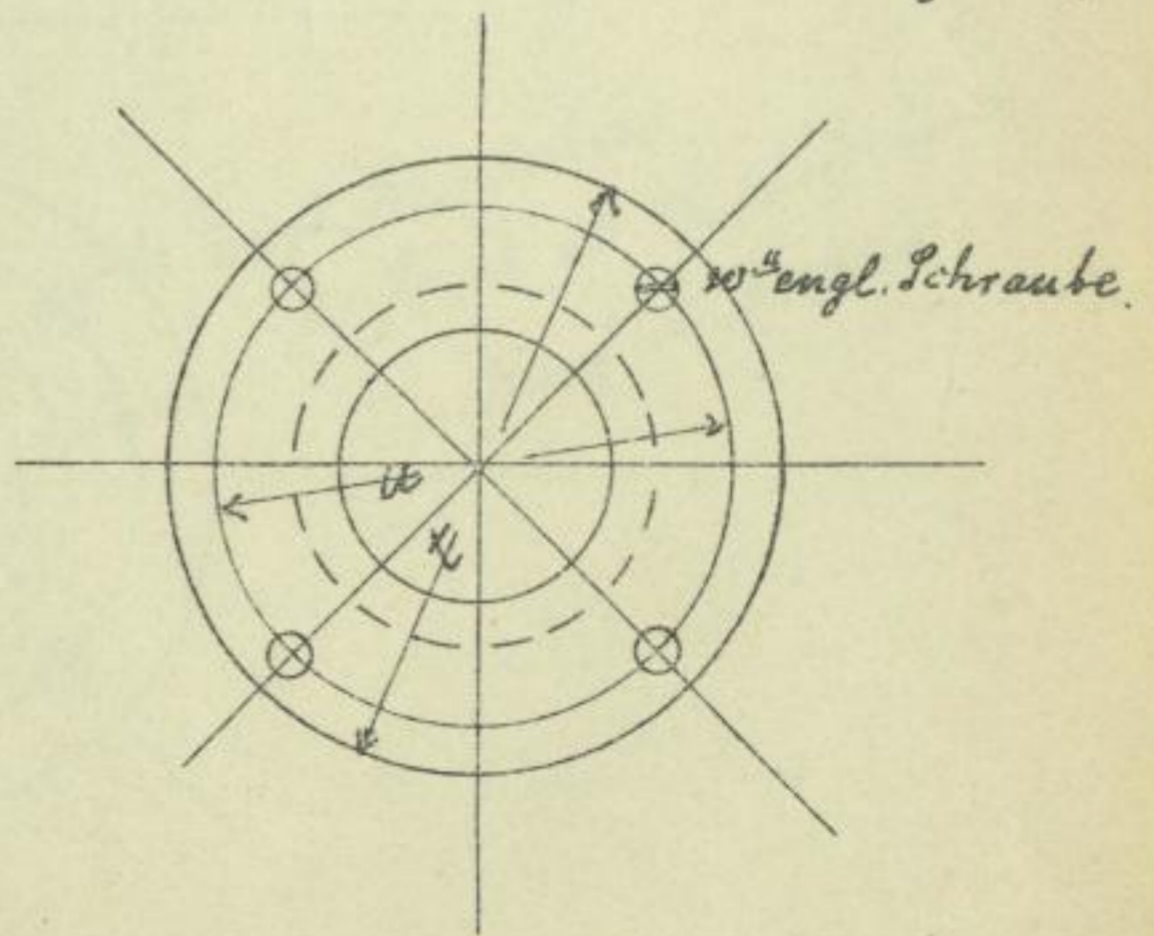
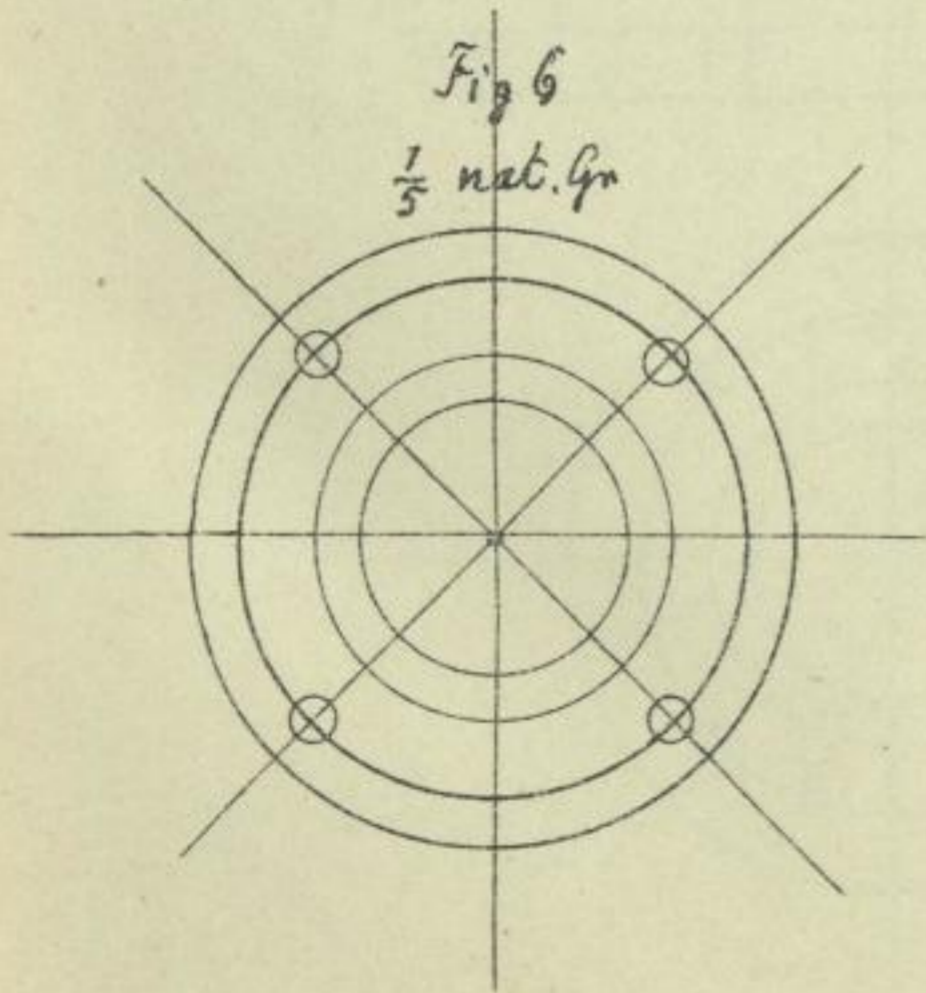
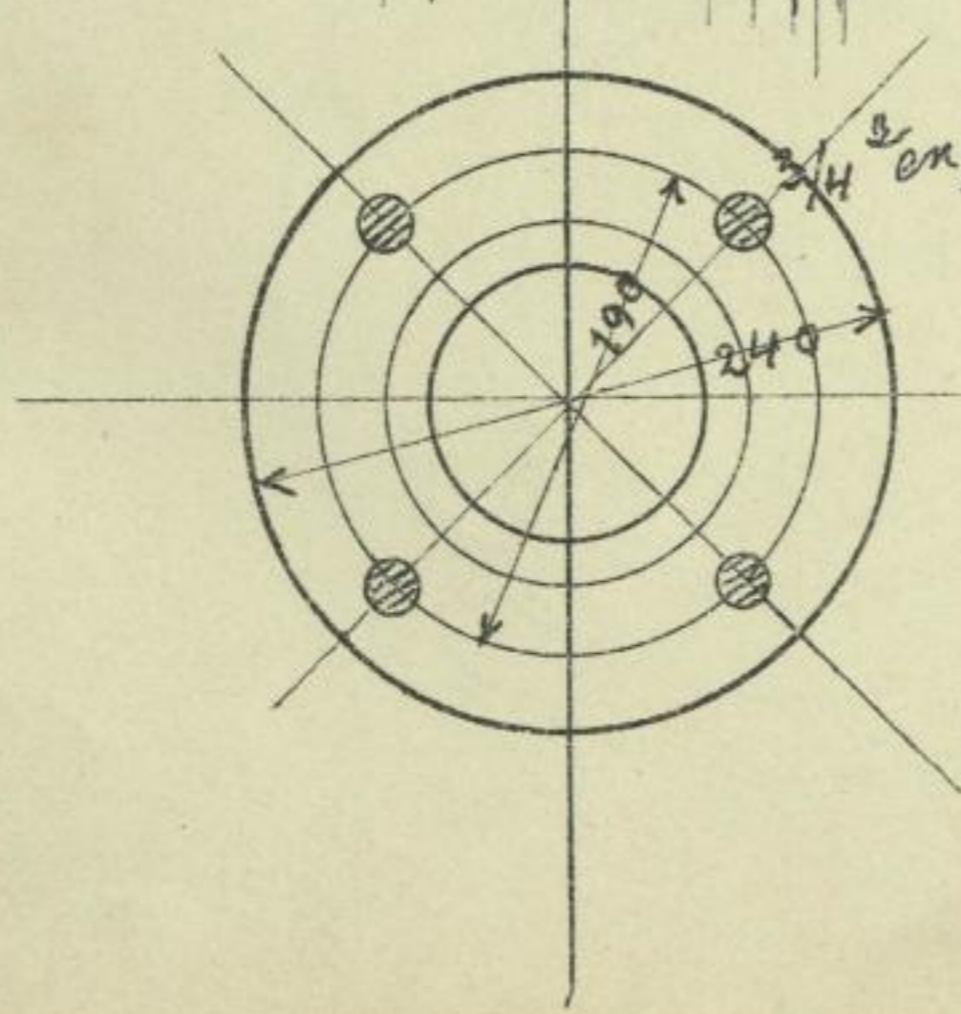
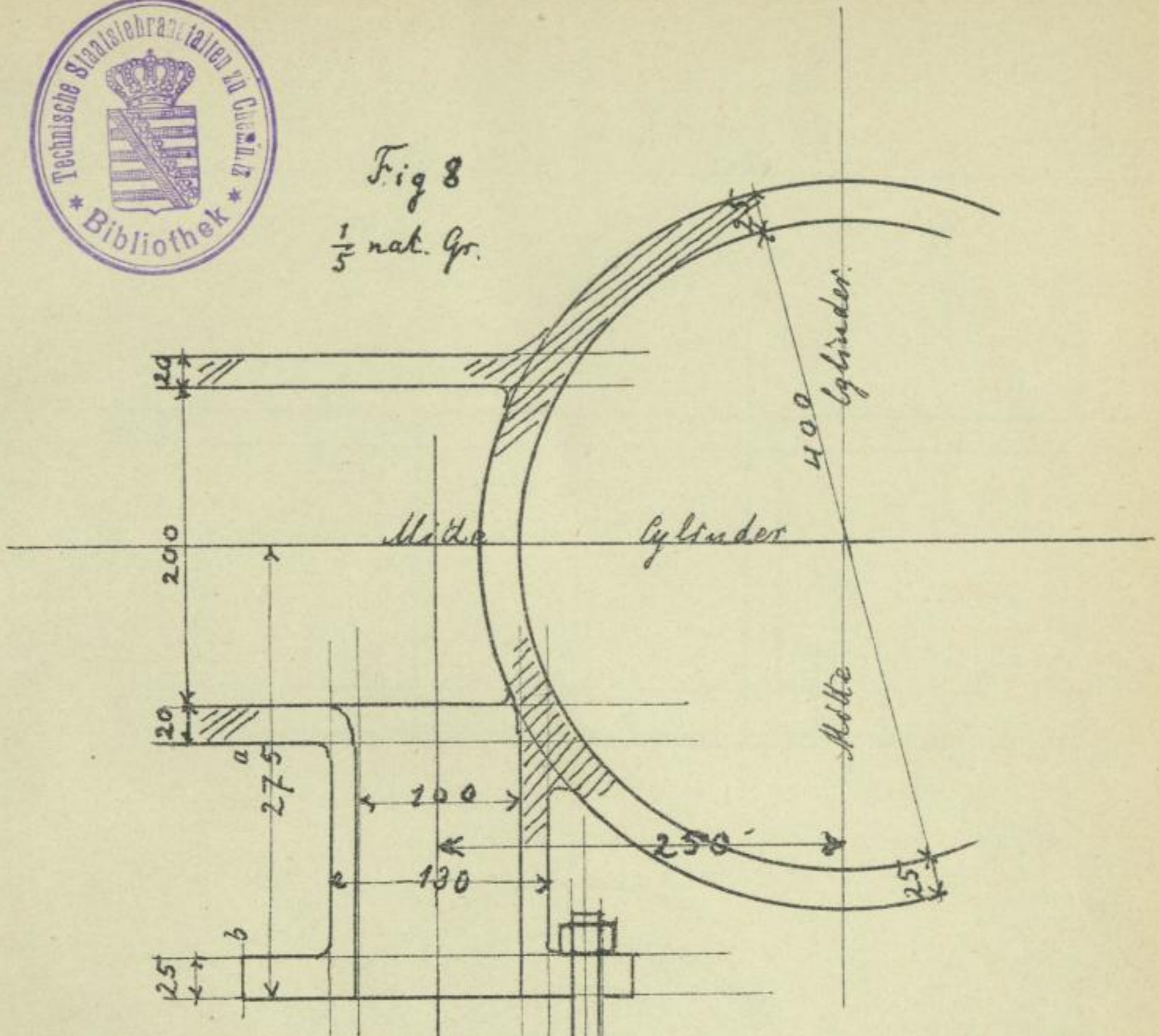



Fig 8
 $\frac{1}{5}$ nat. Gr.



4 engl. Schrauben
 4 Stücke, 50 mm zwischen
 Kopf u. Mutter

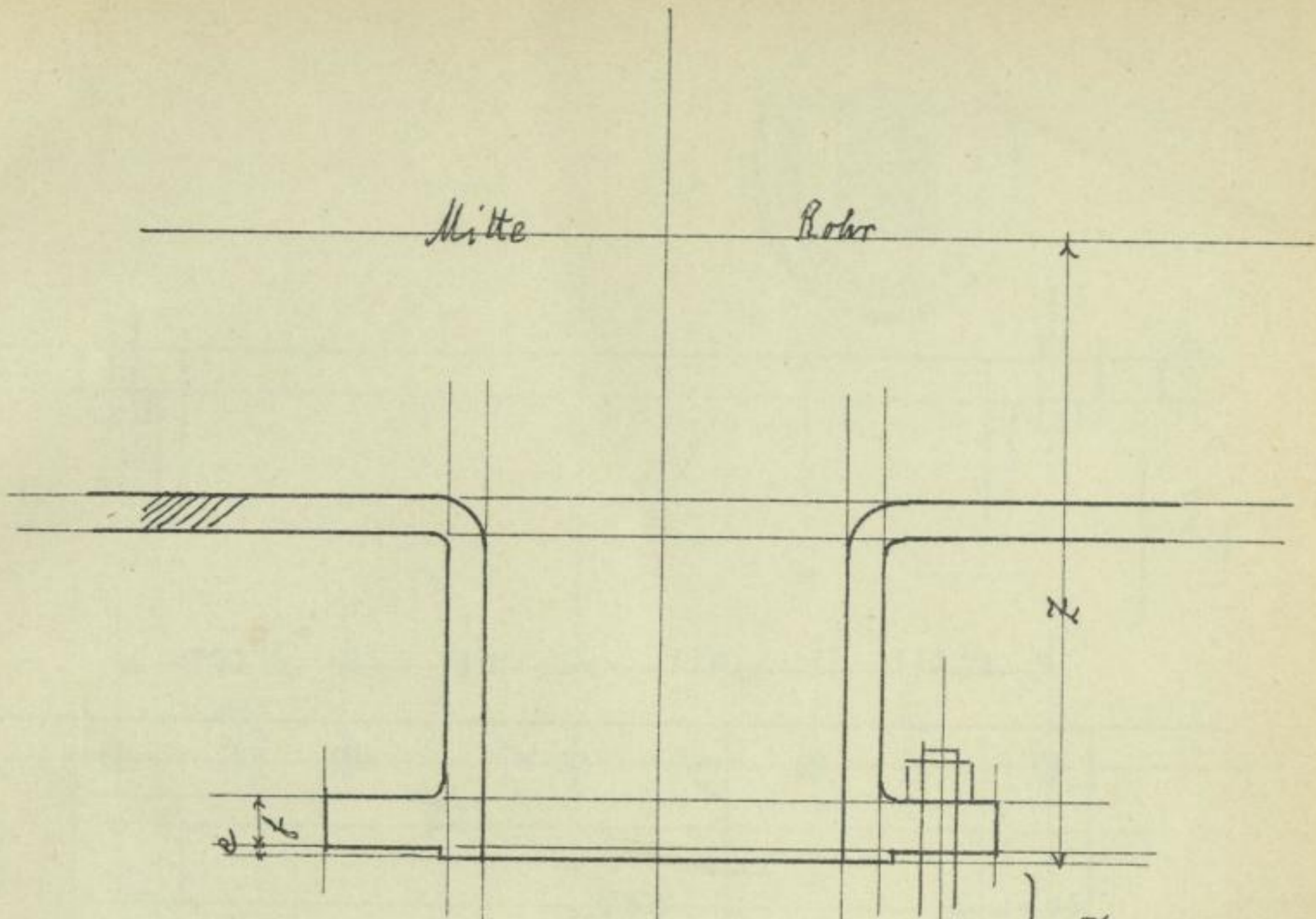
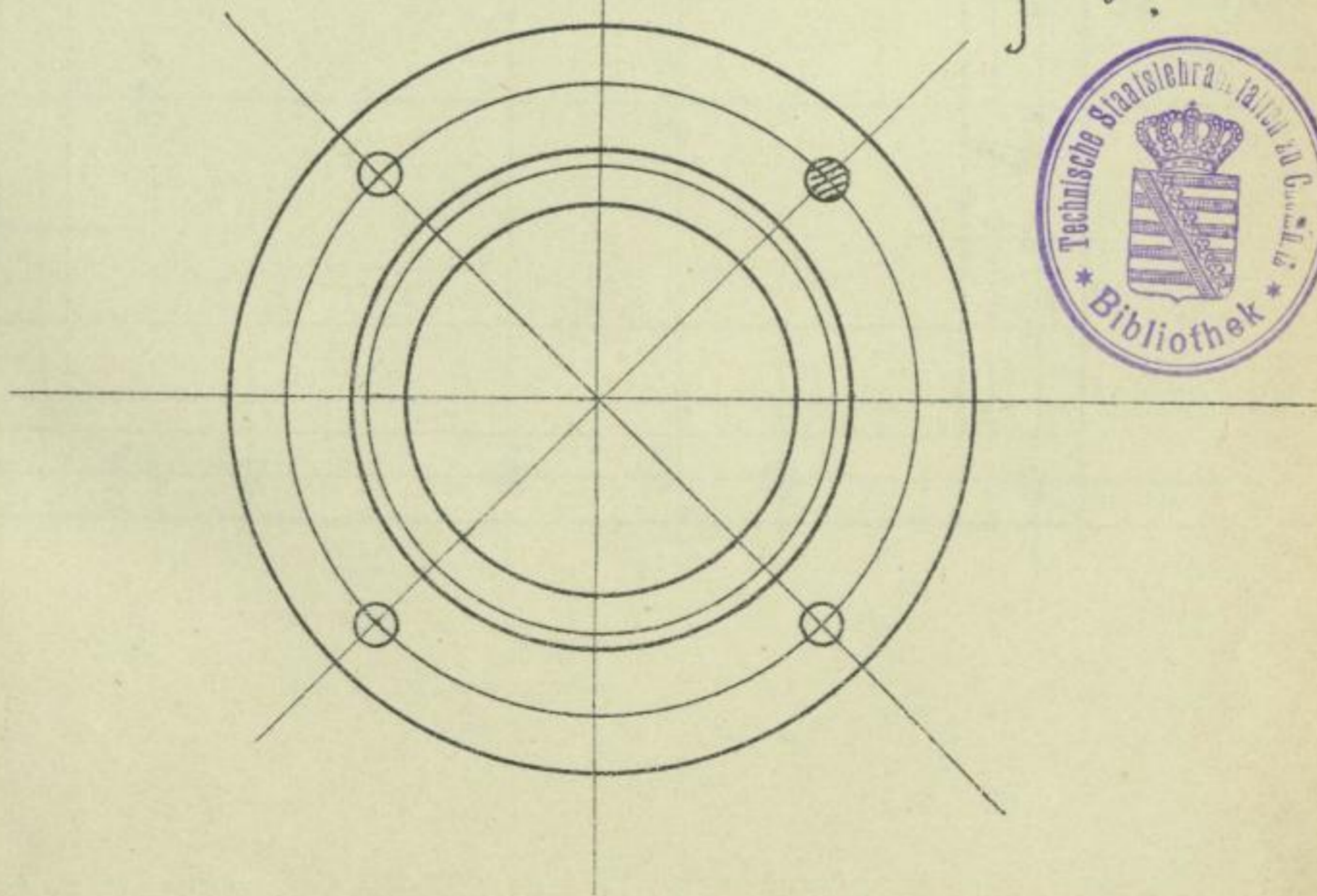
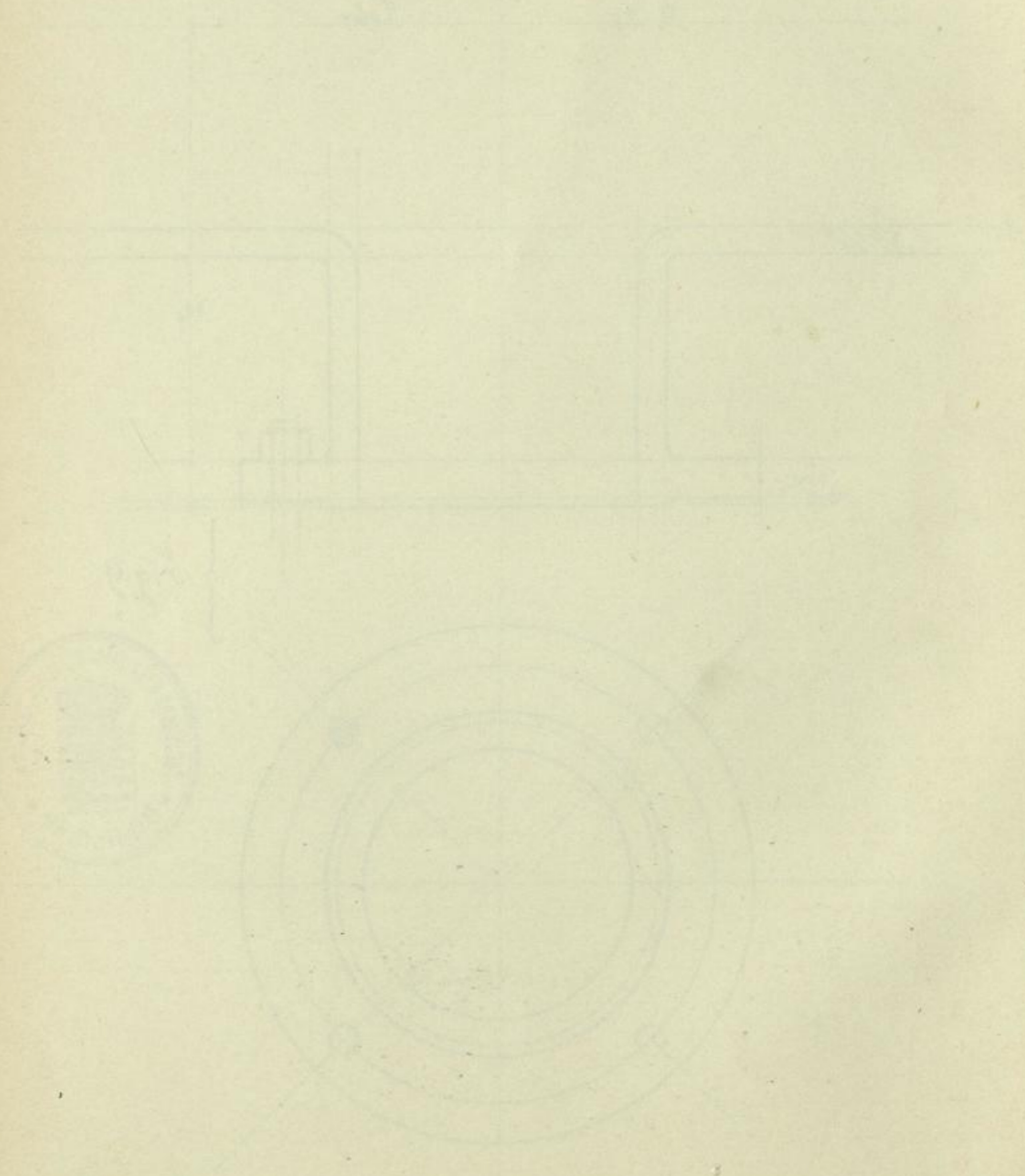

Fig. 9.





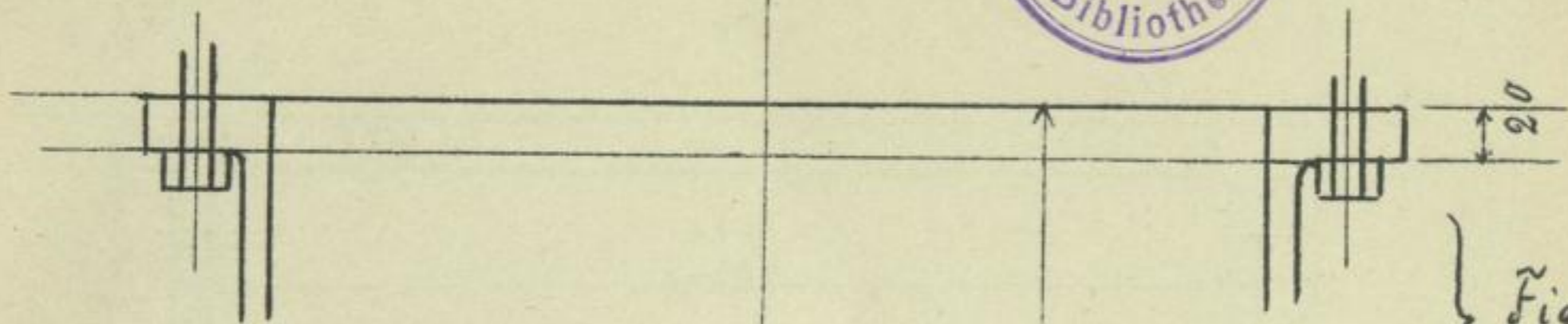
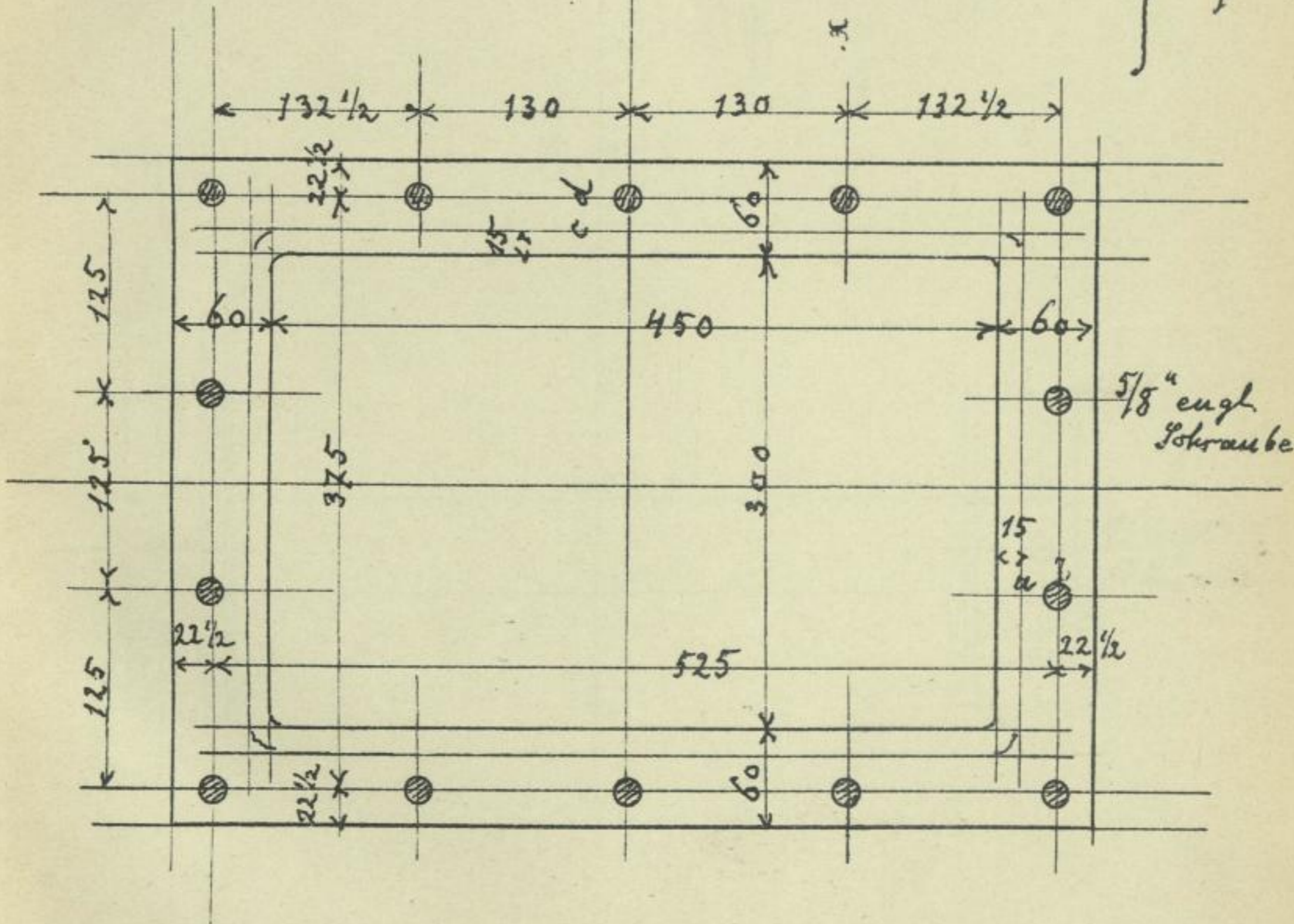

Fig 10.



A large, faint grid or table structure covers most of the page. The grid consists of approximately 10 columns and 10 rows. The lines are very light and the content within the cells is completely illegible.

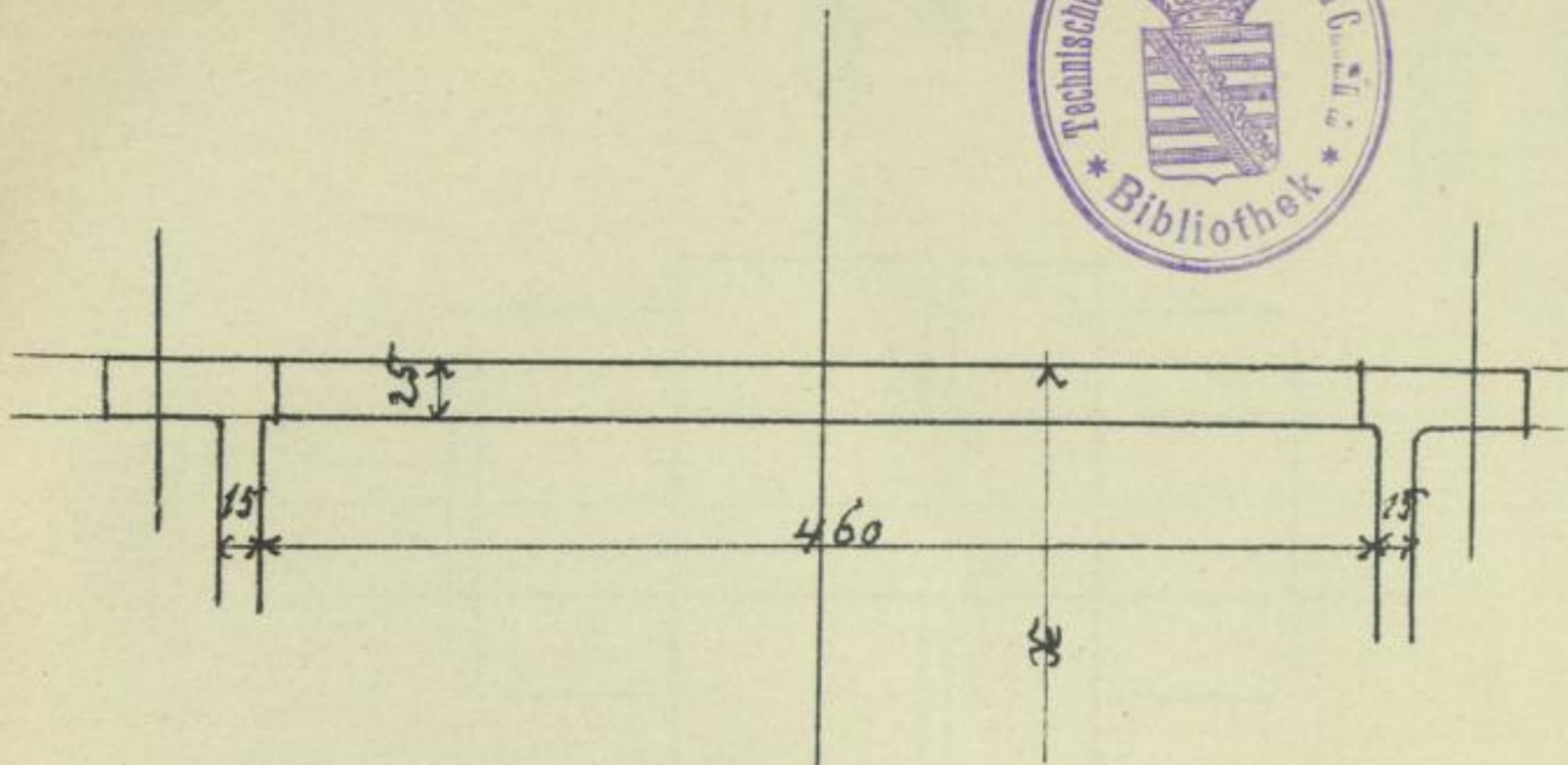
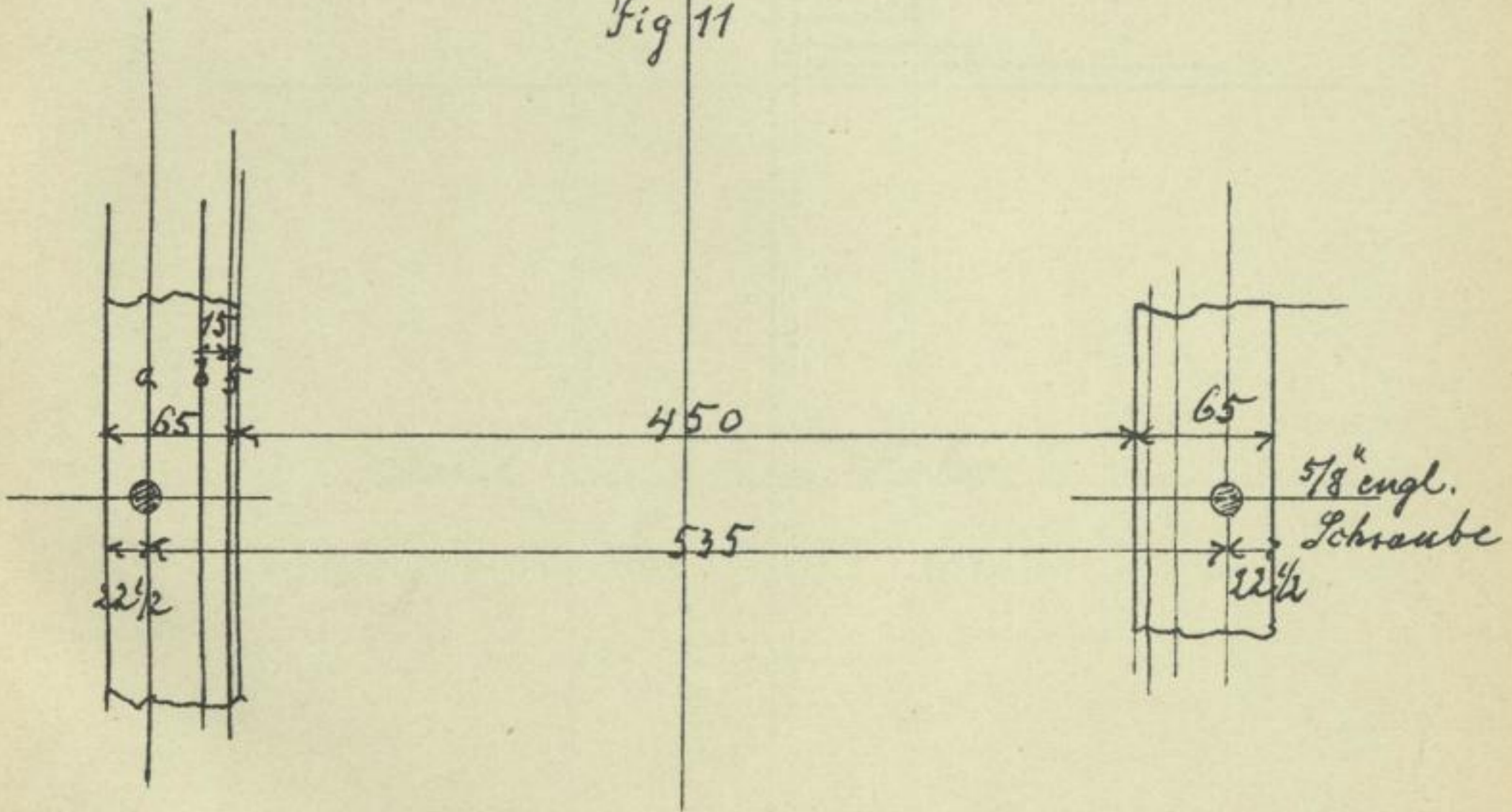

Fig 11



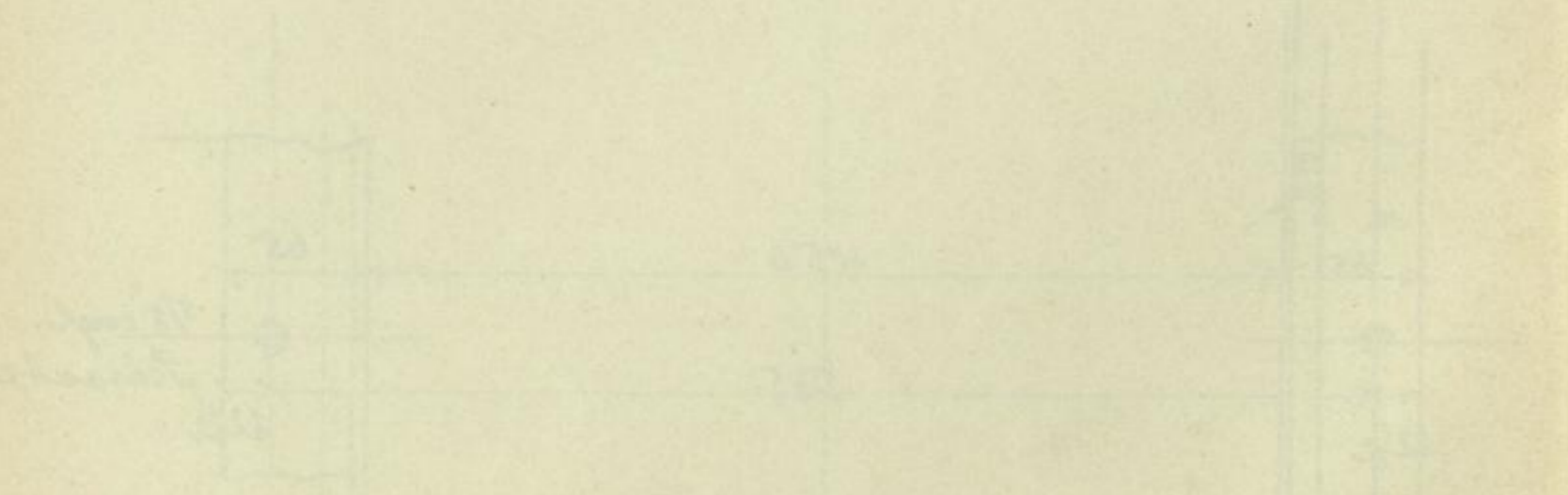
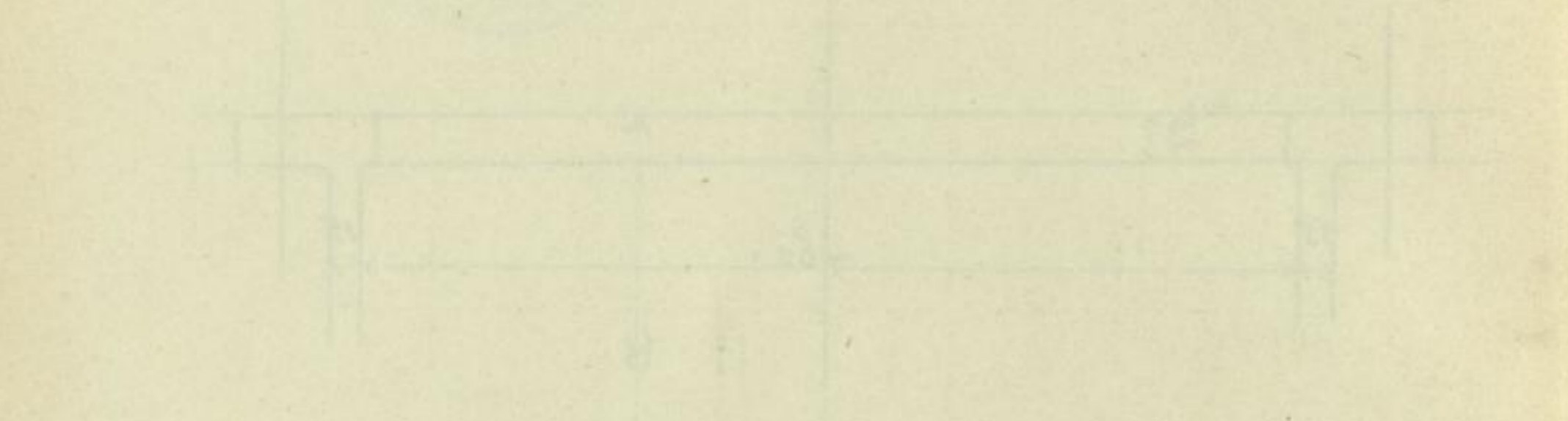

Fig 12

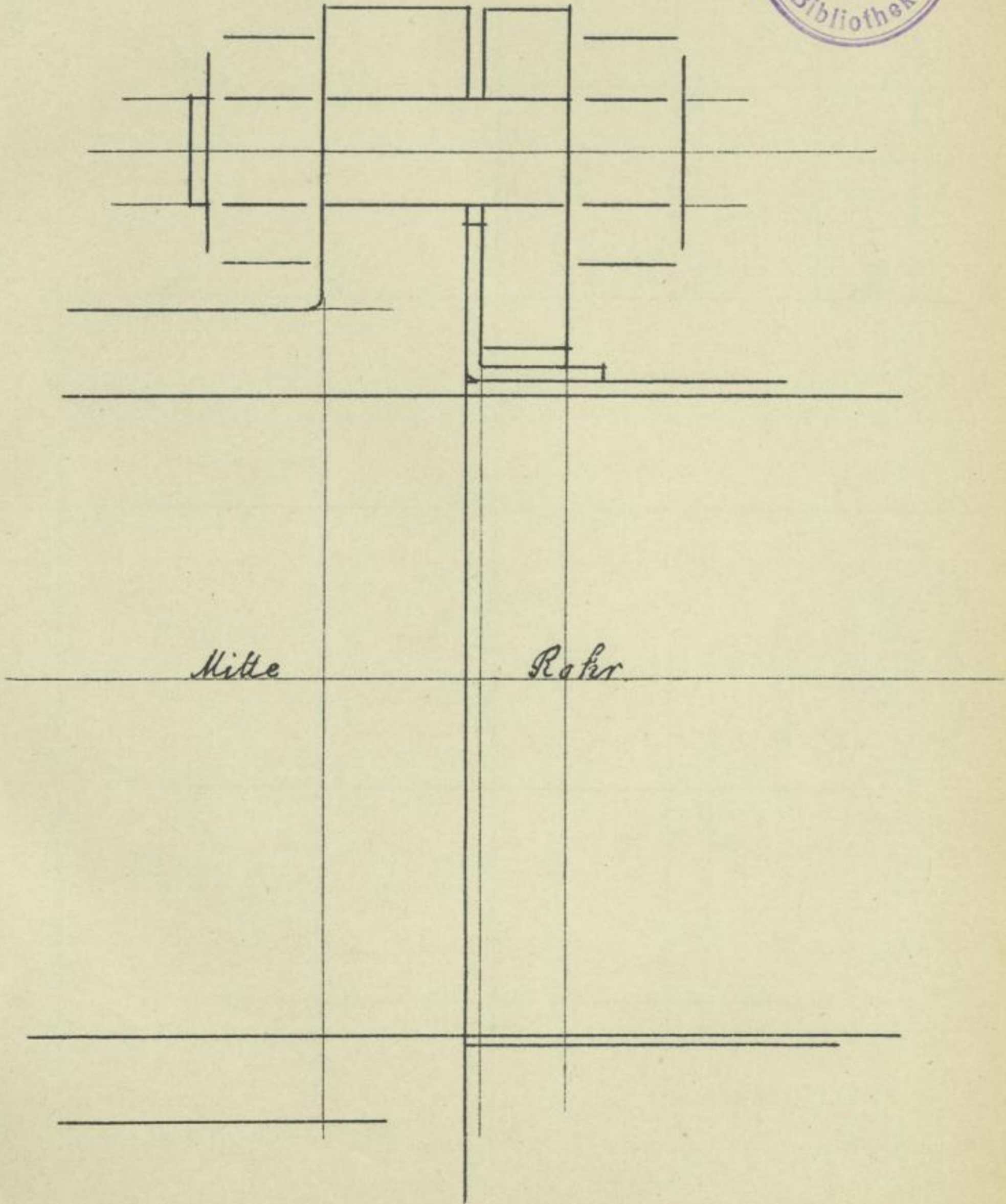

Fig 13.

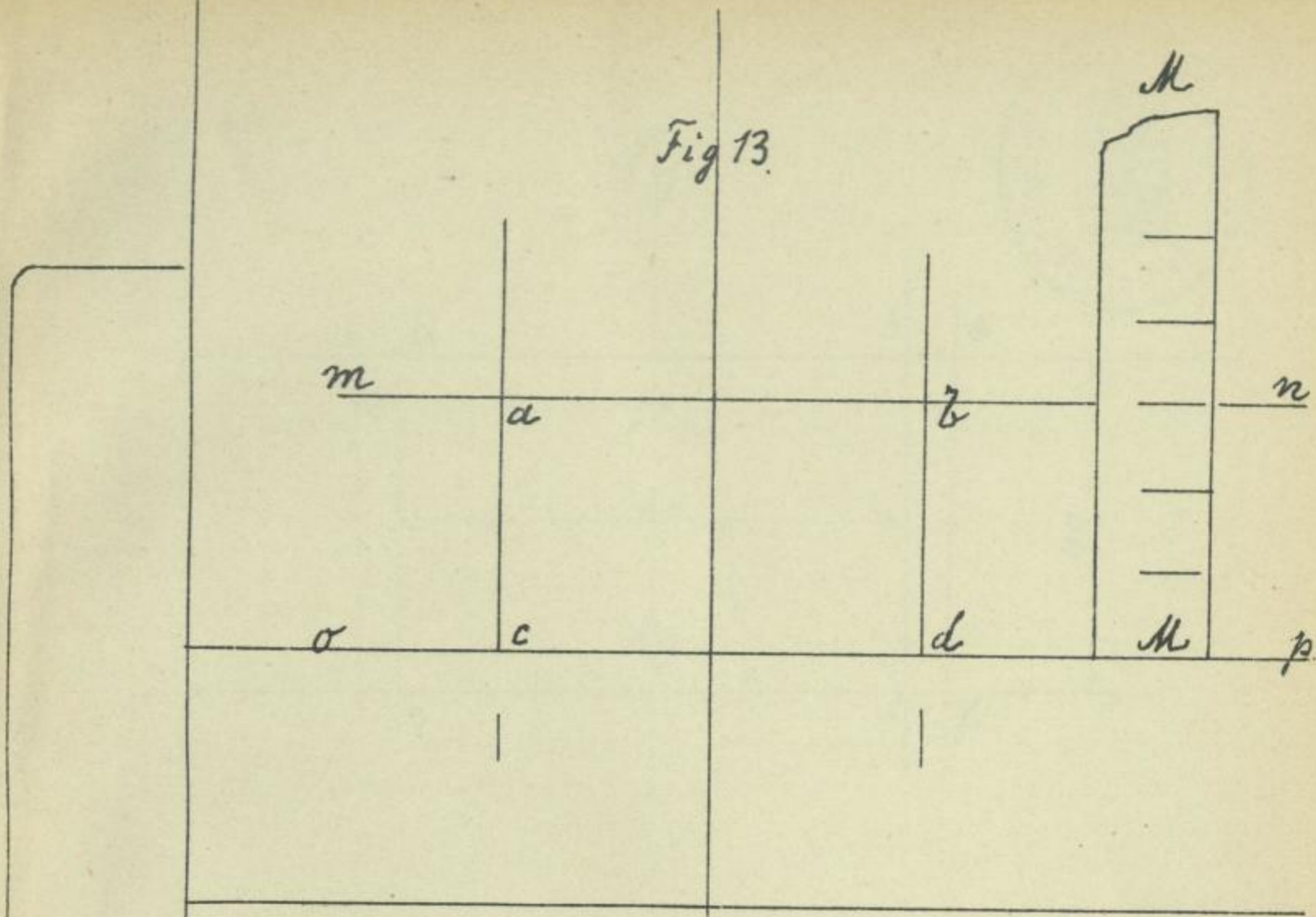

Fig 14.

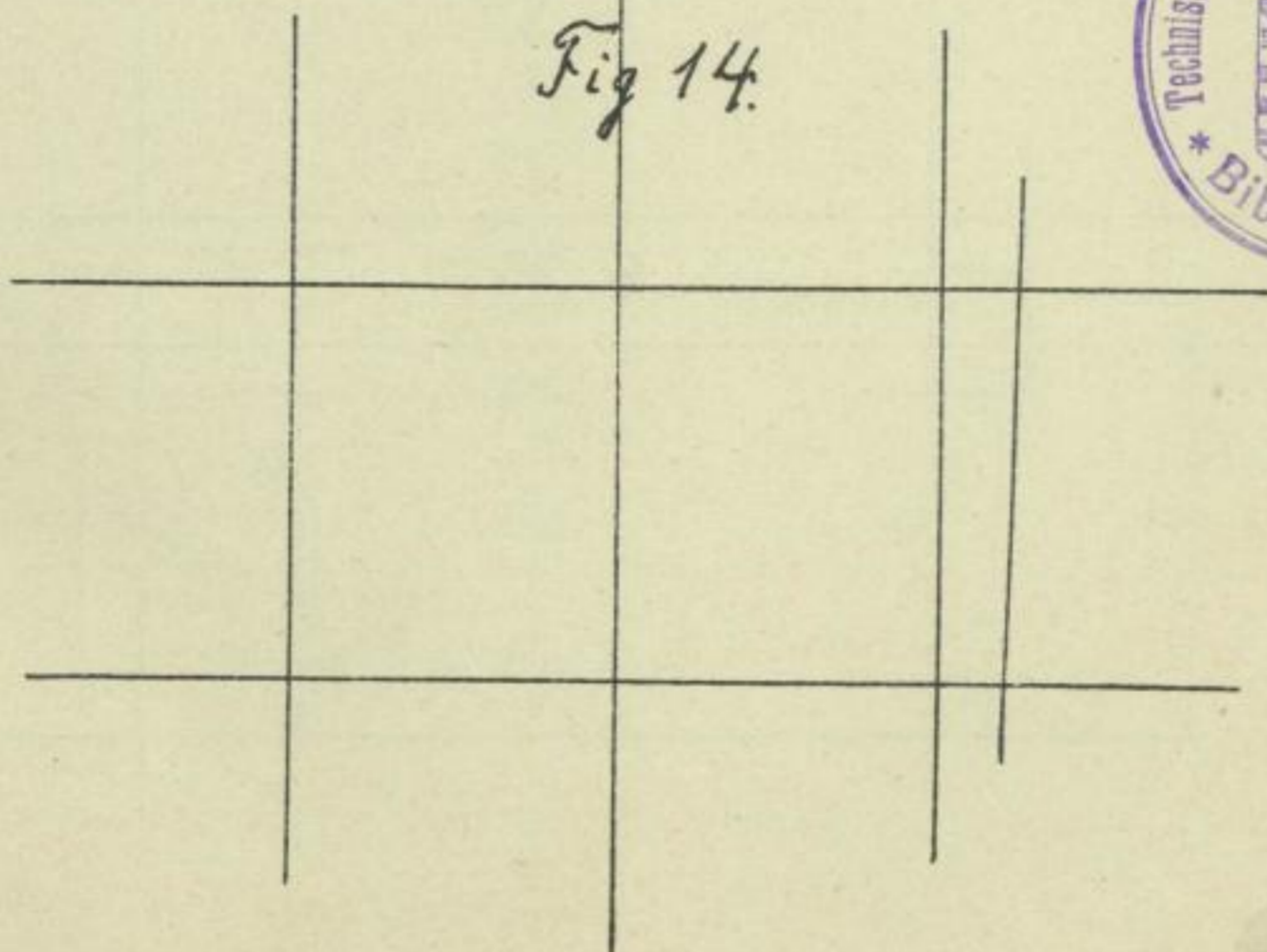

Fig 15

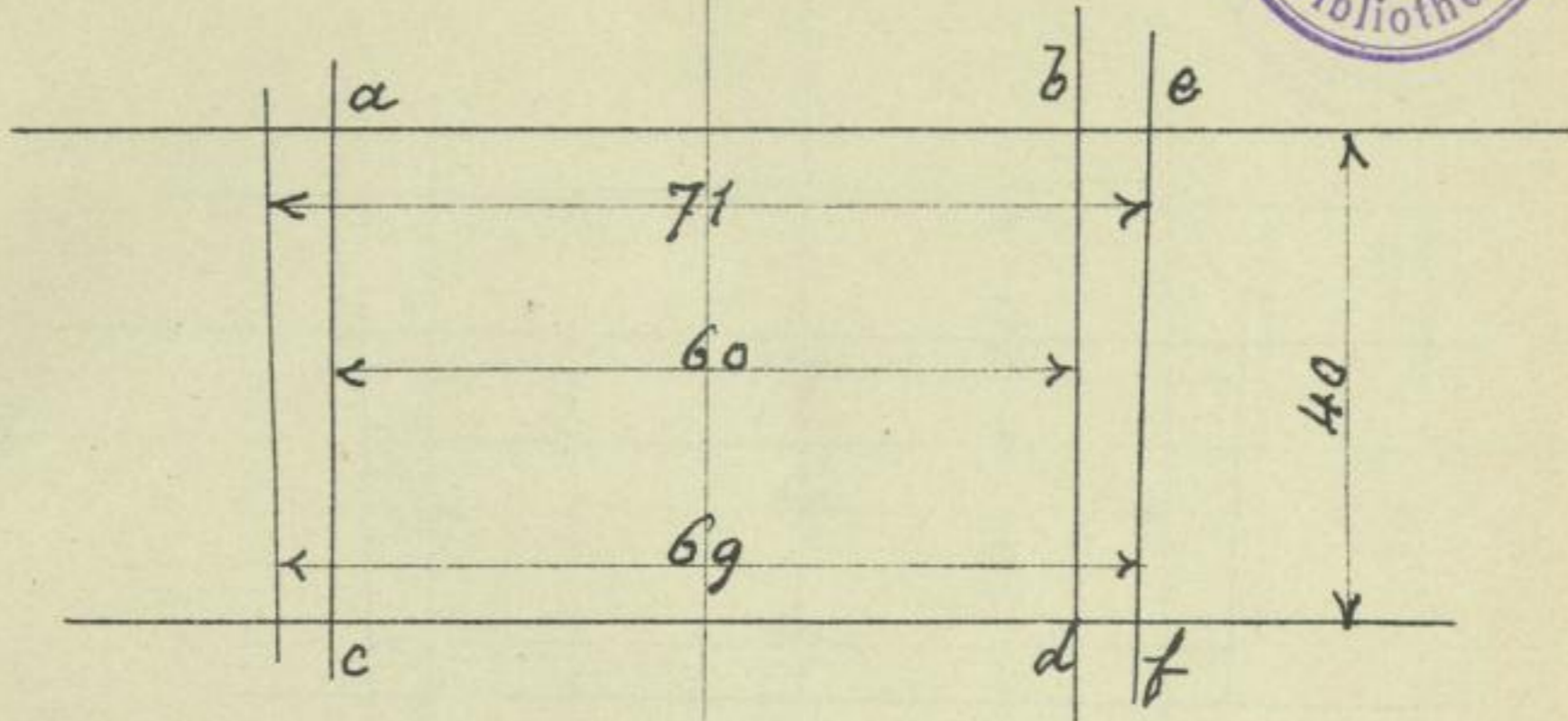

Fig 16

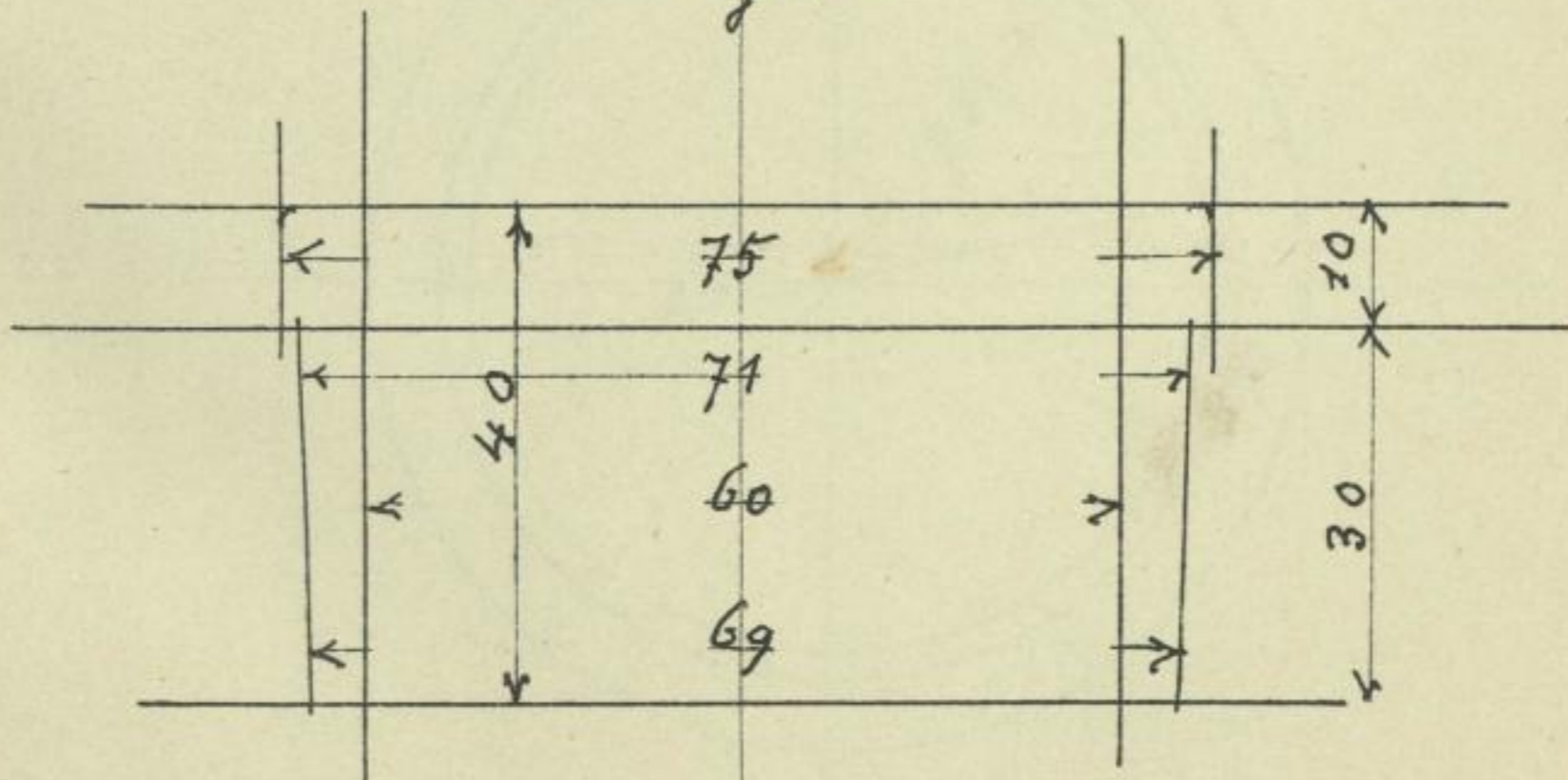



Fig 17

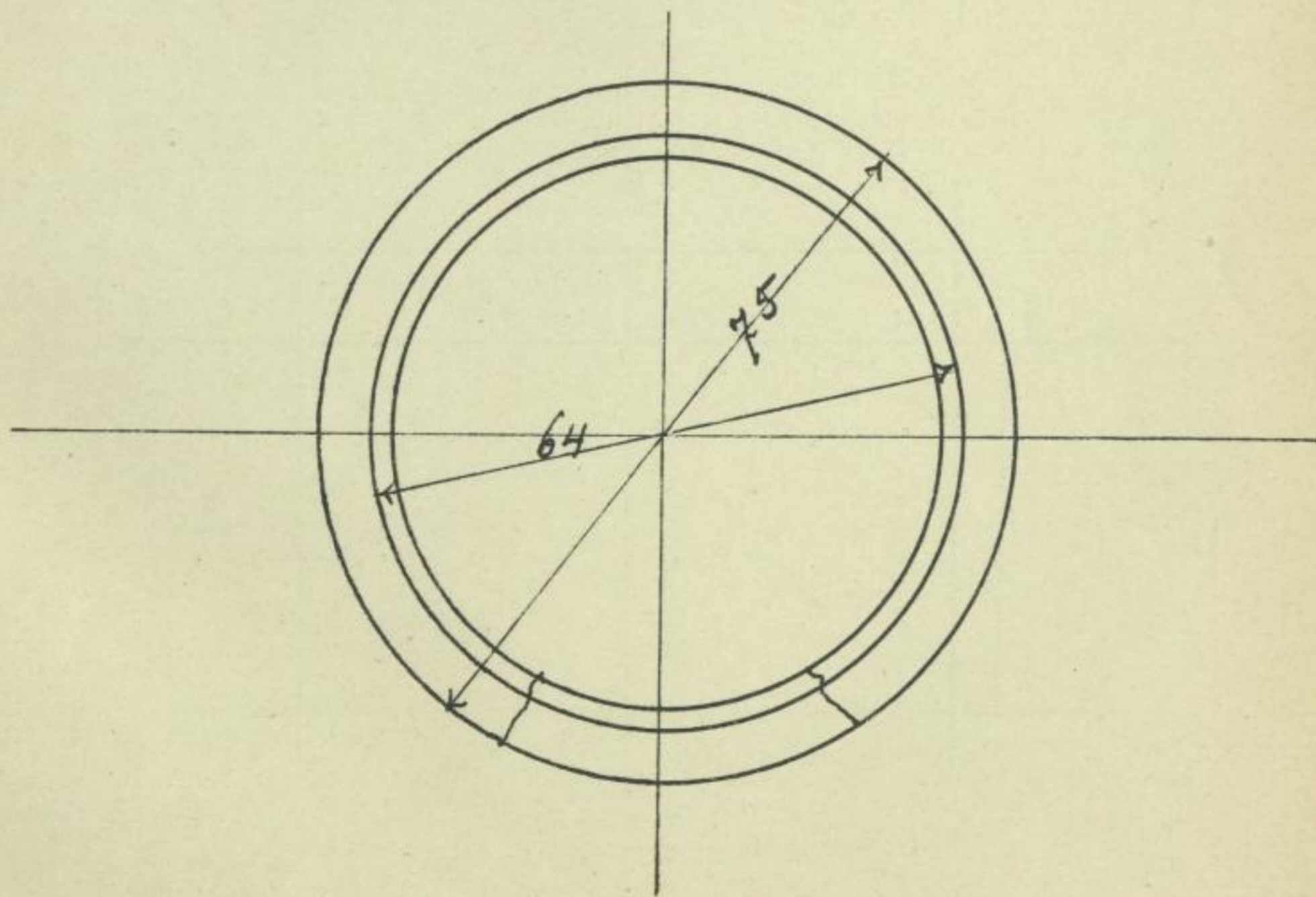
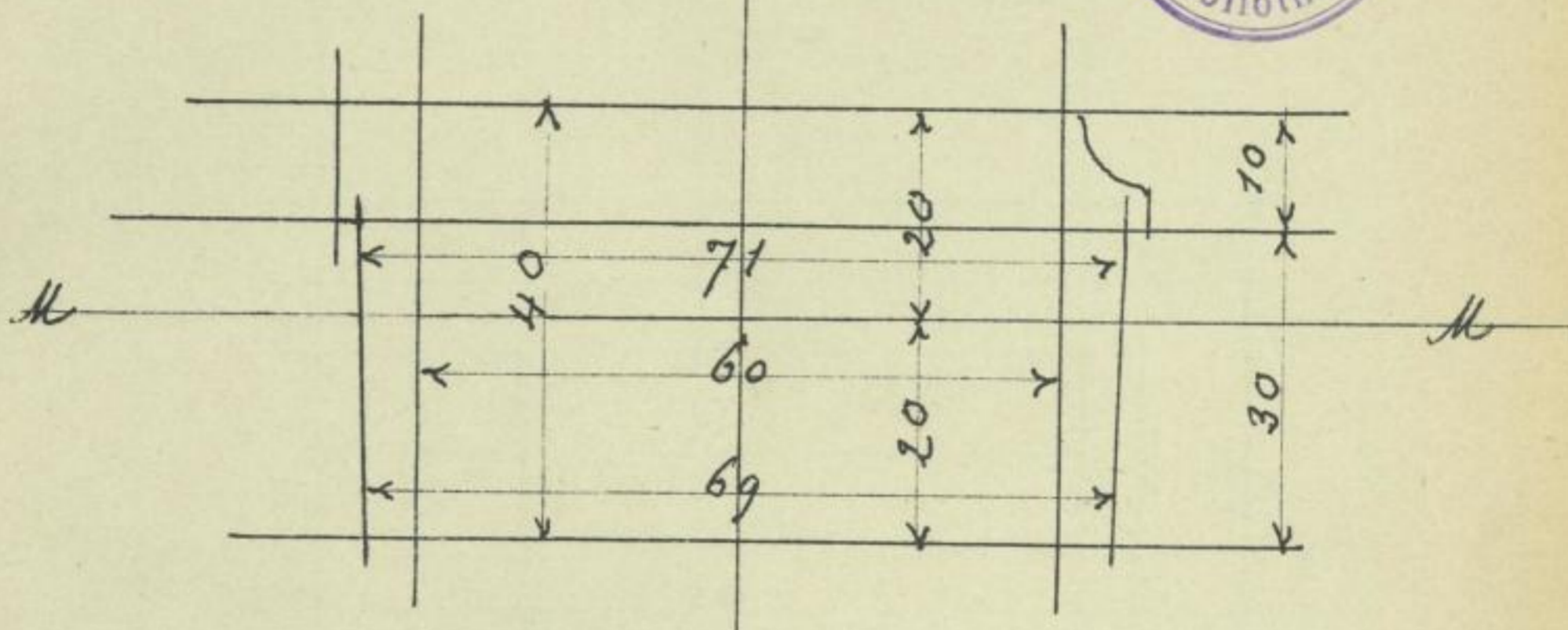



Fig 18

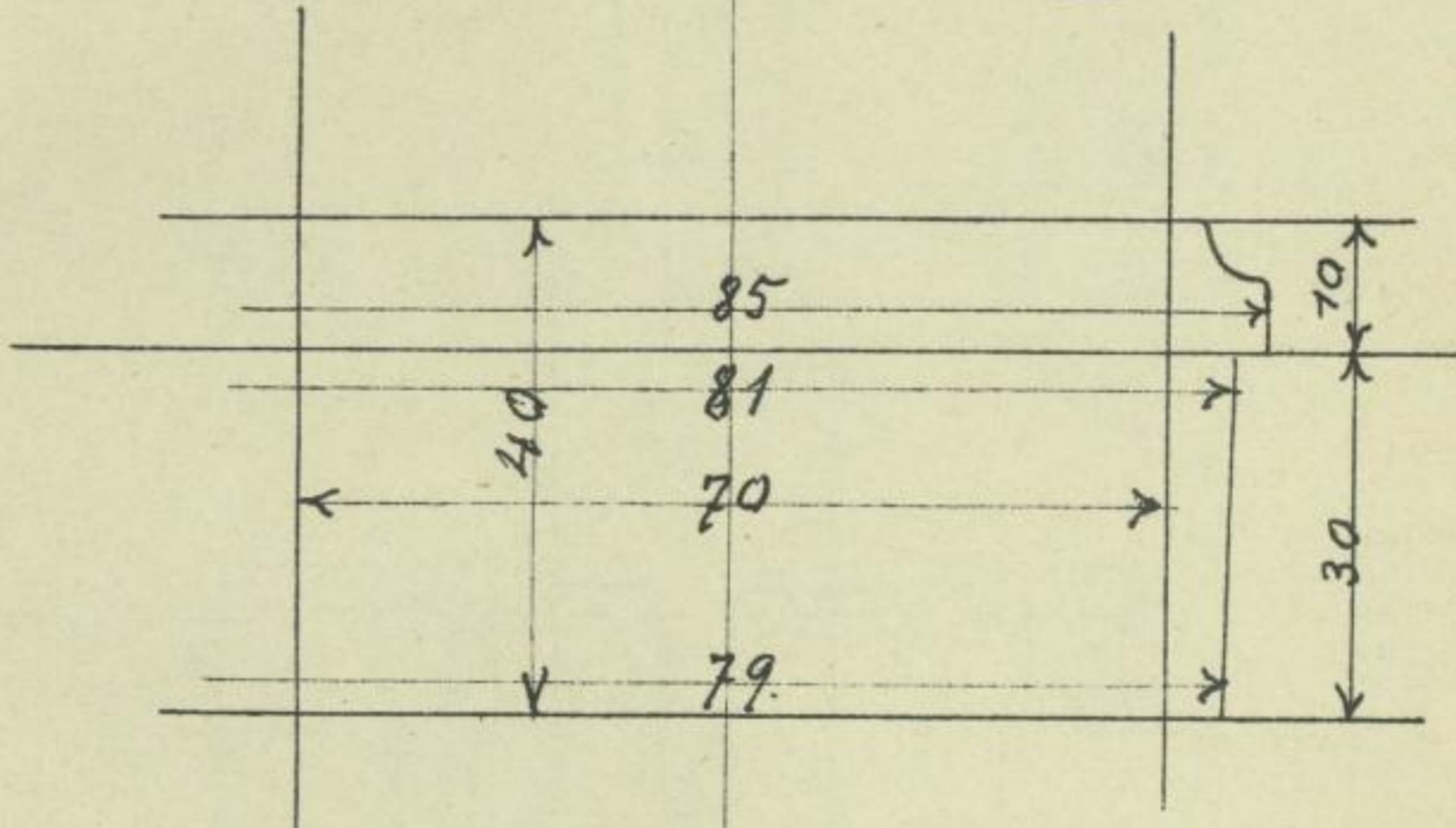

Fig 19.

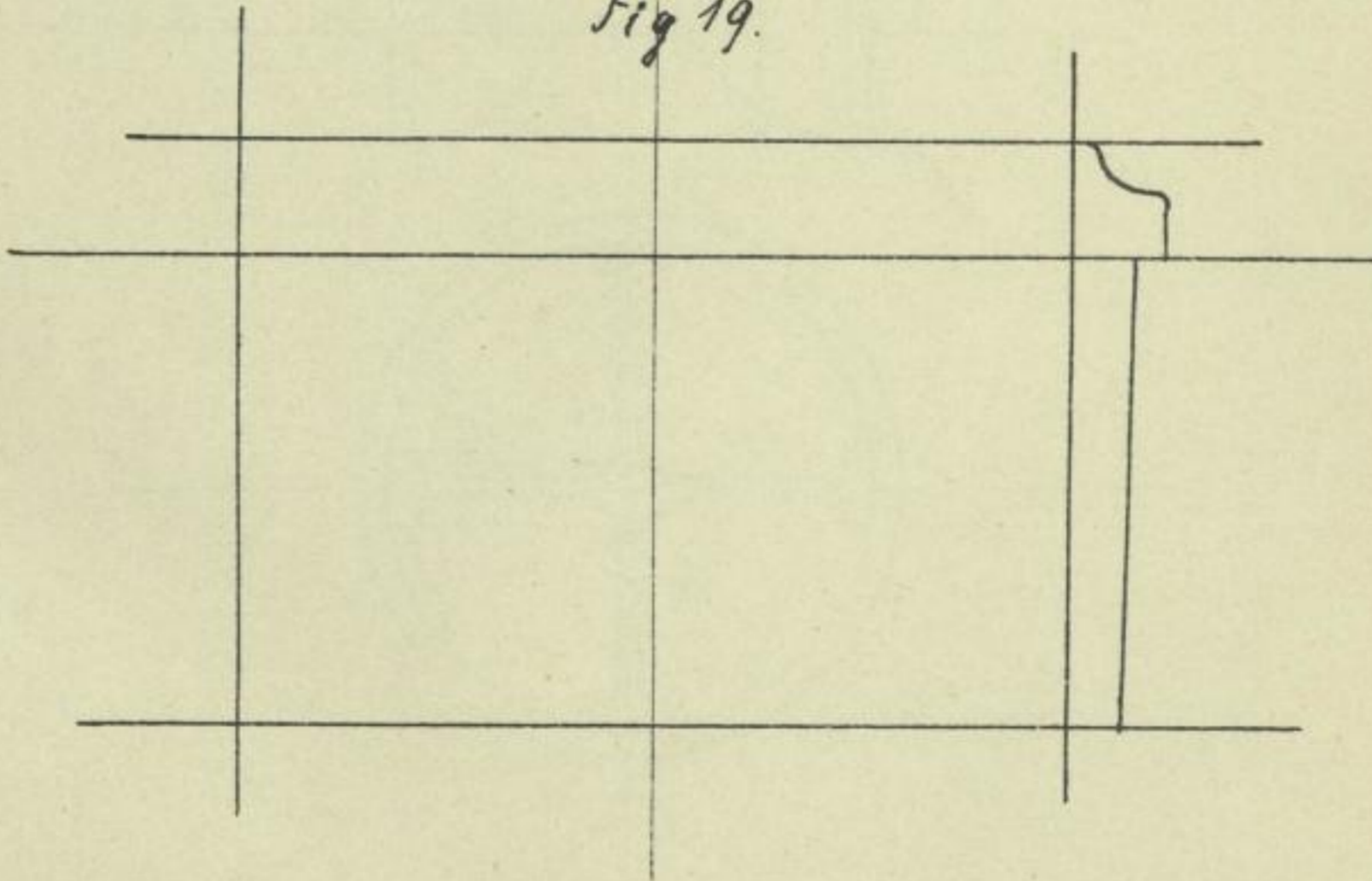
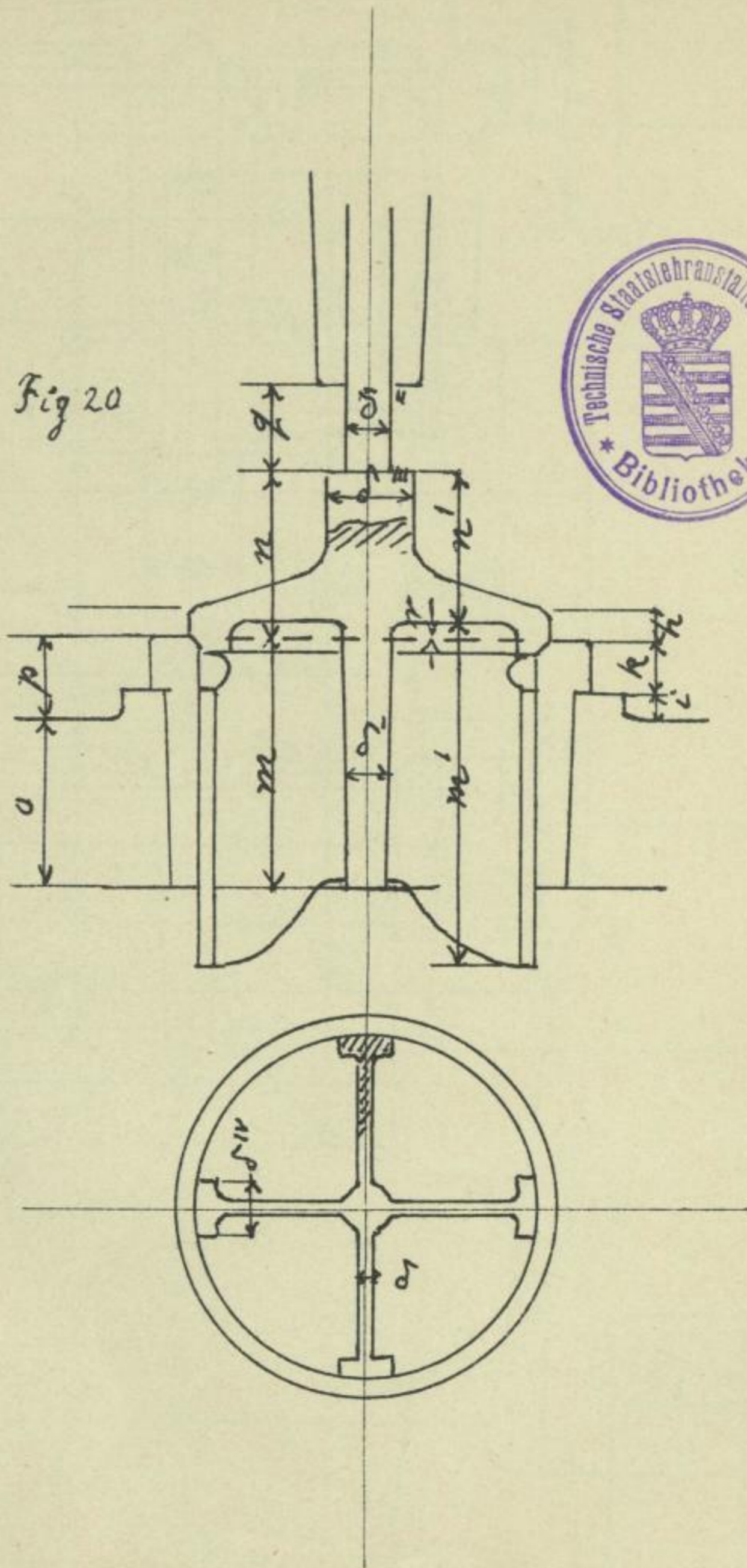
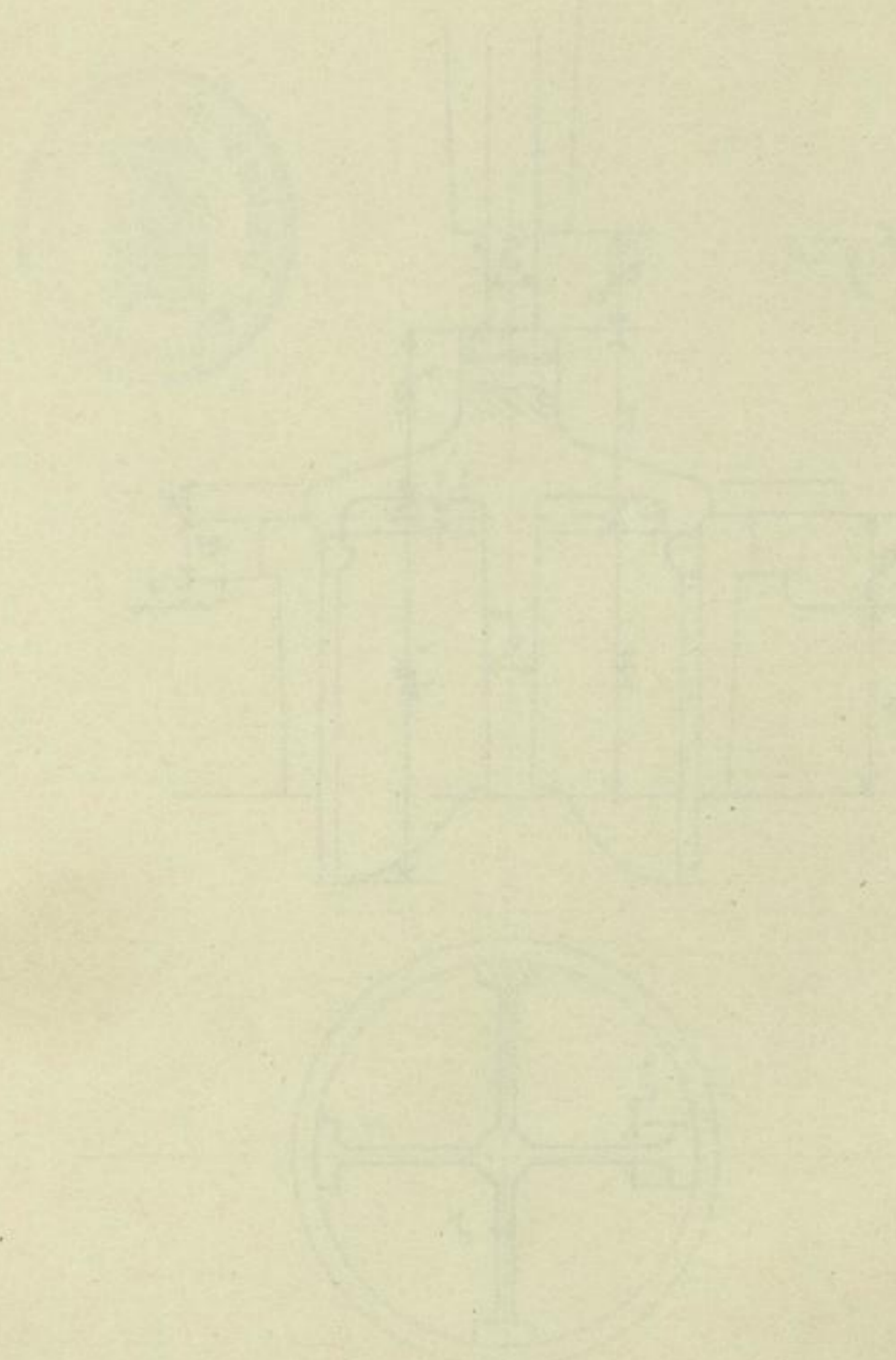

Fig 20





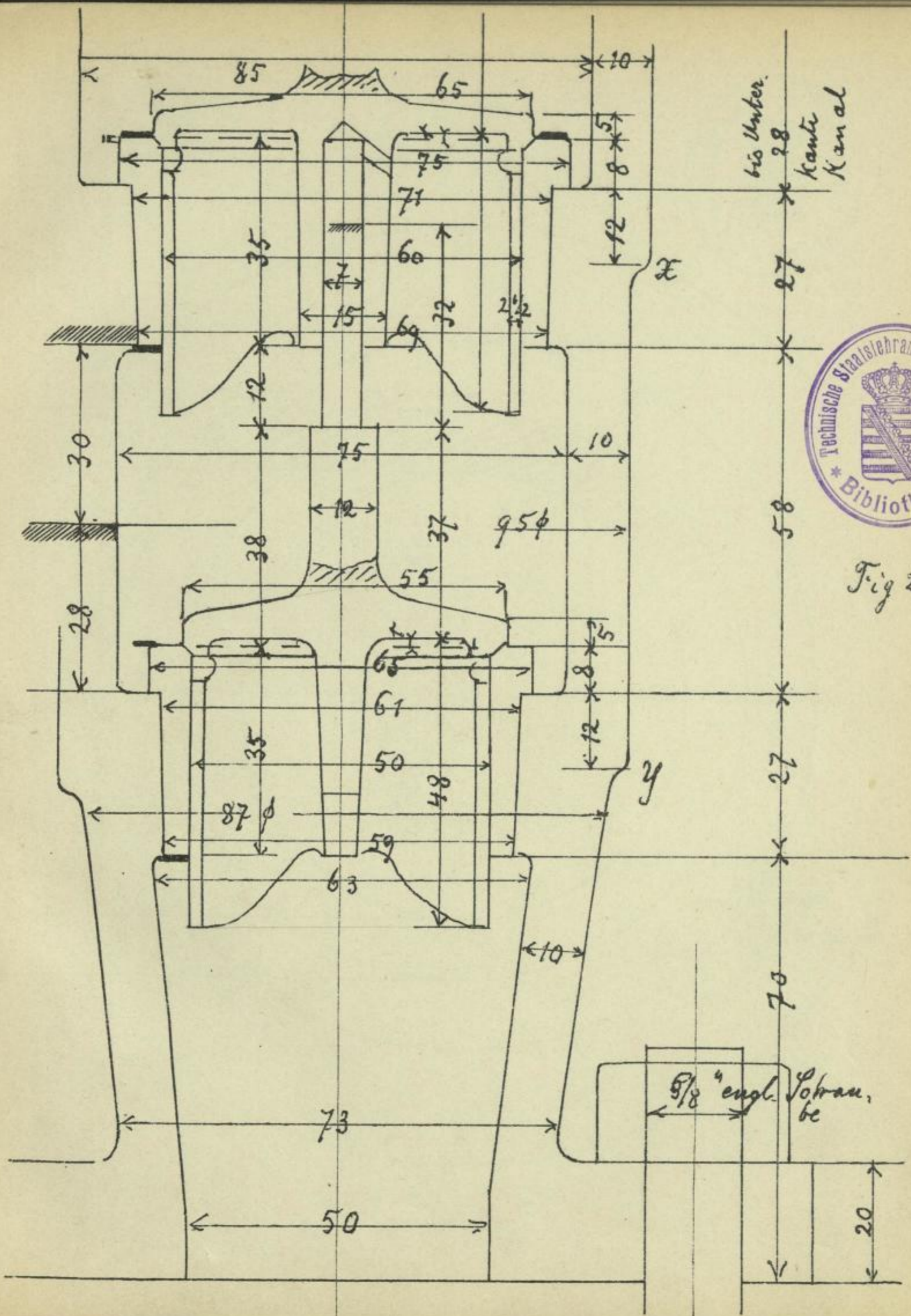

Fig 21



Fig 22.

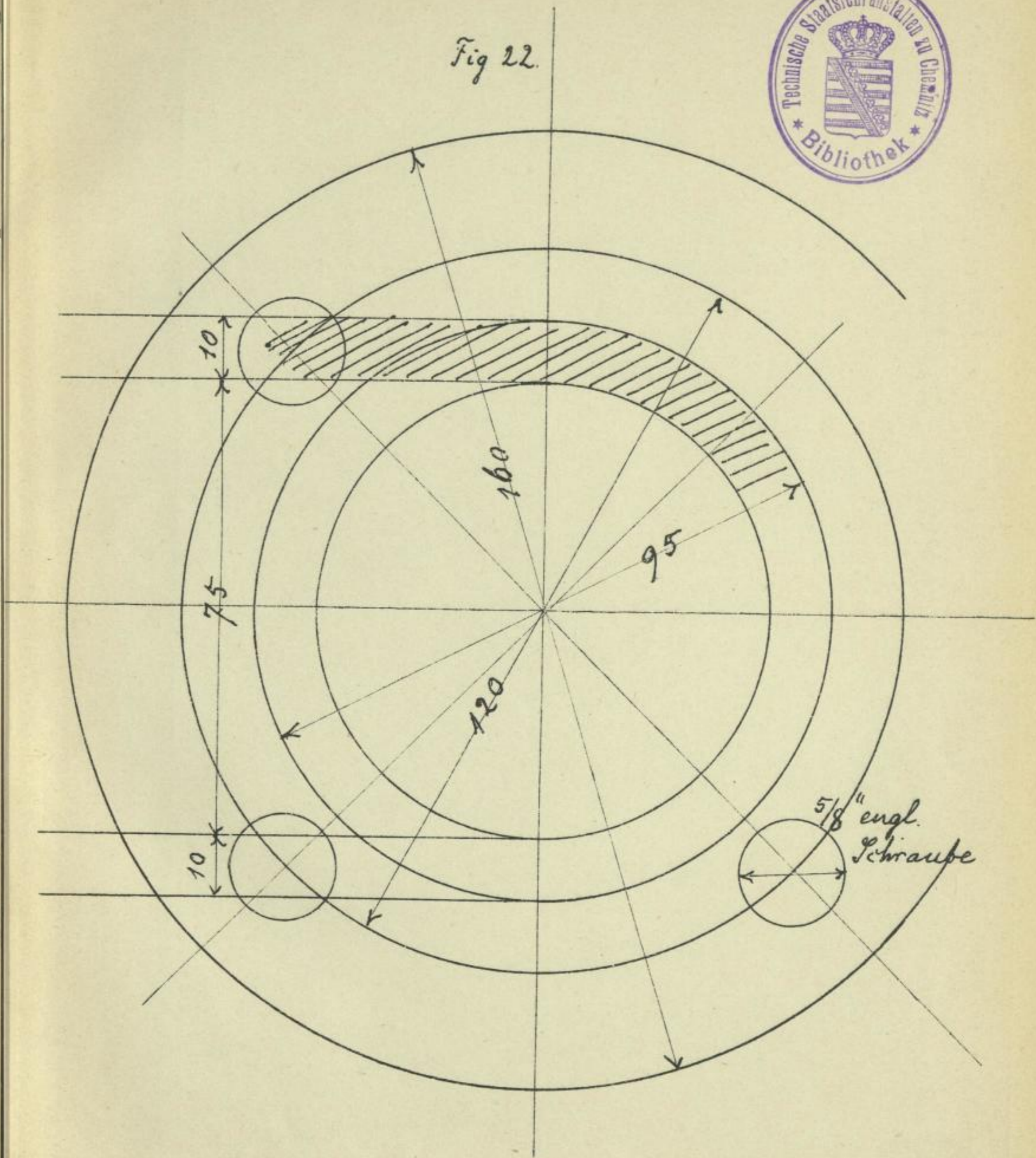
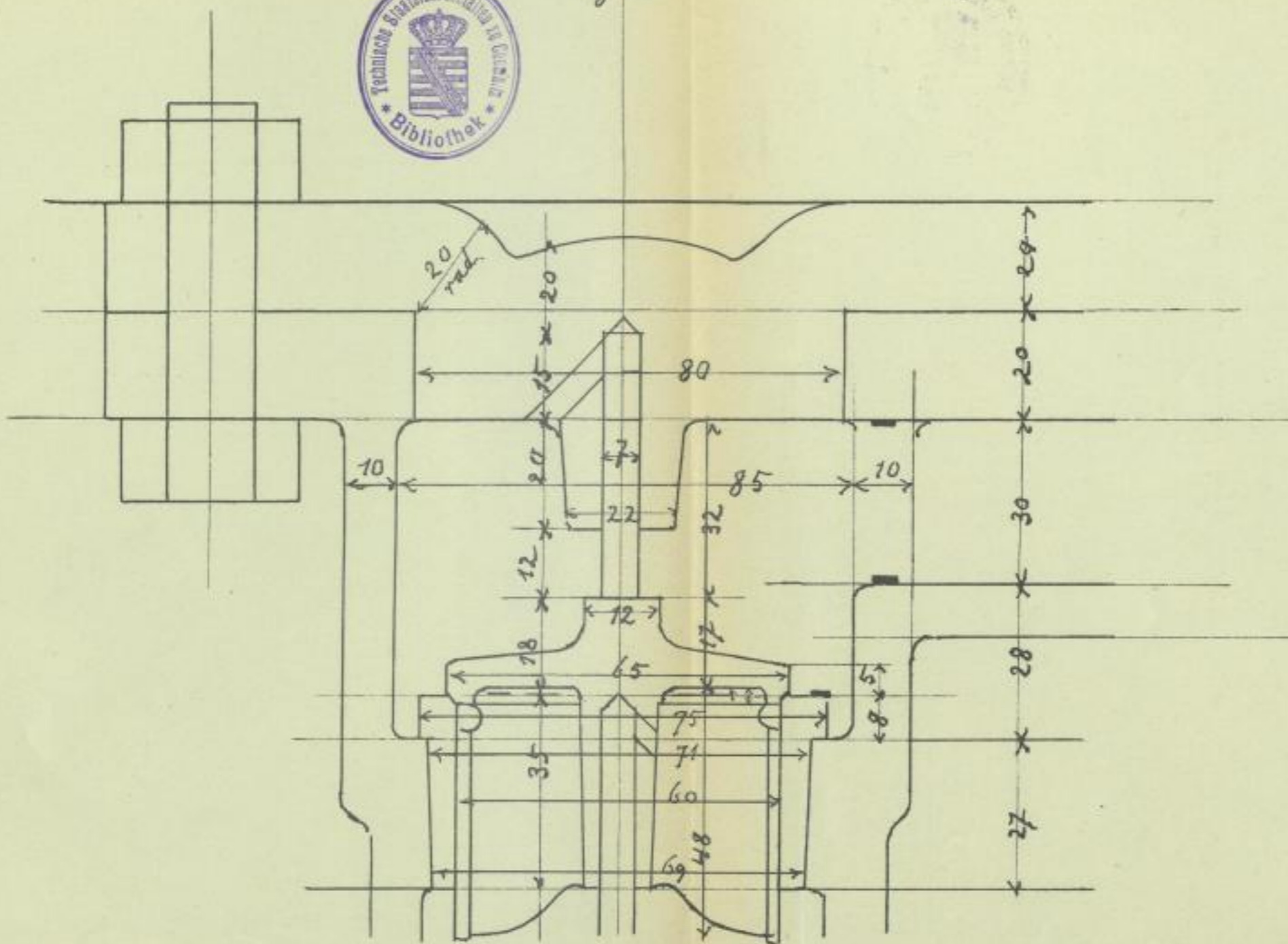

Fig 23





Mitt
Ch...

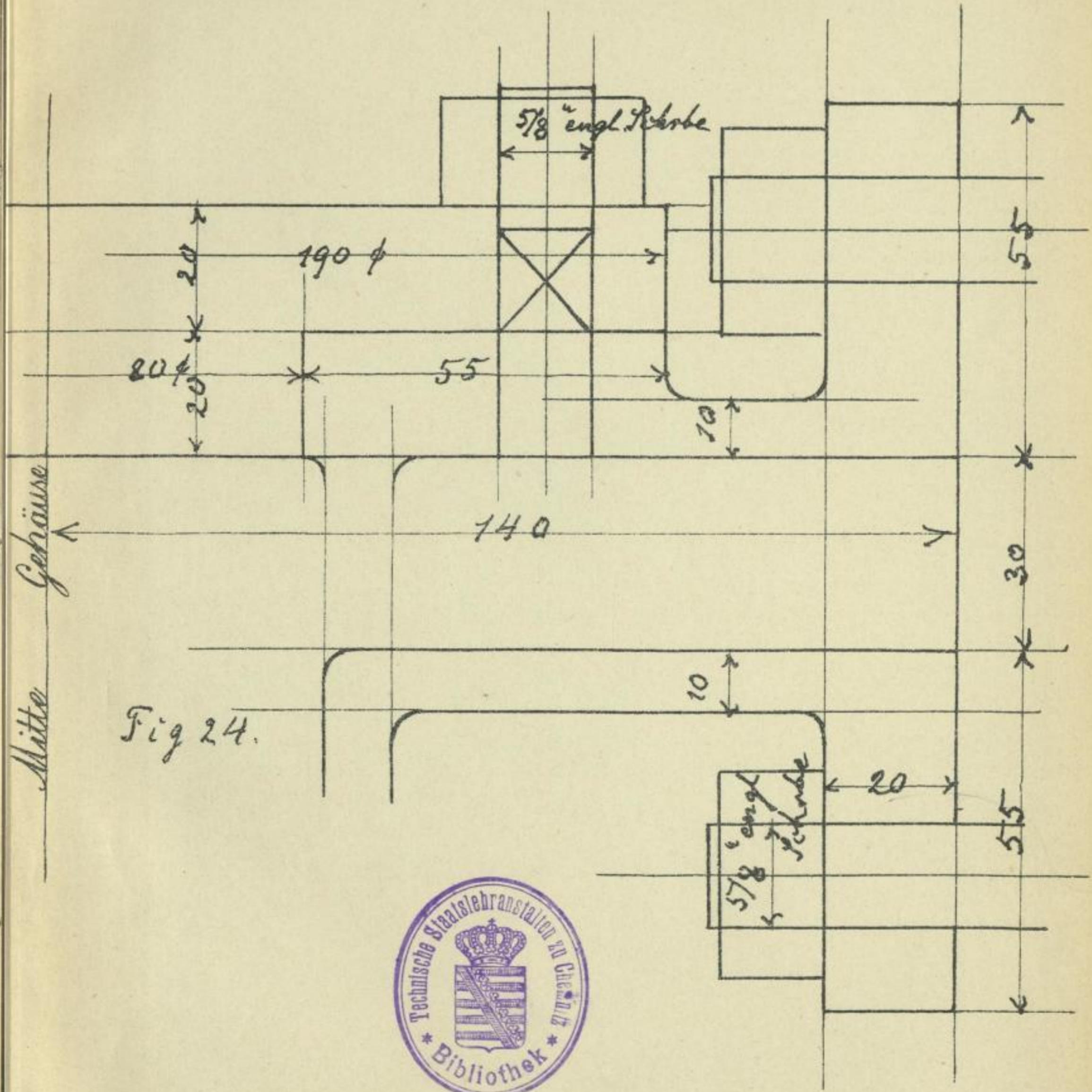

Fig 25

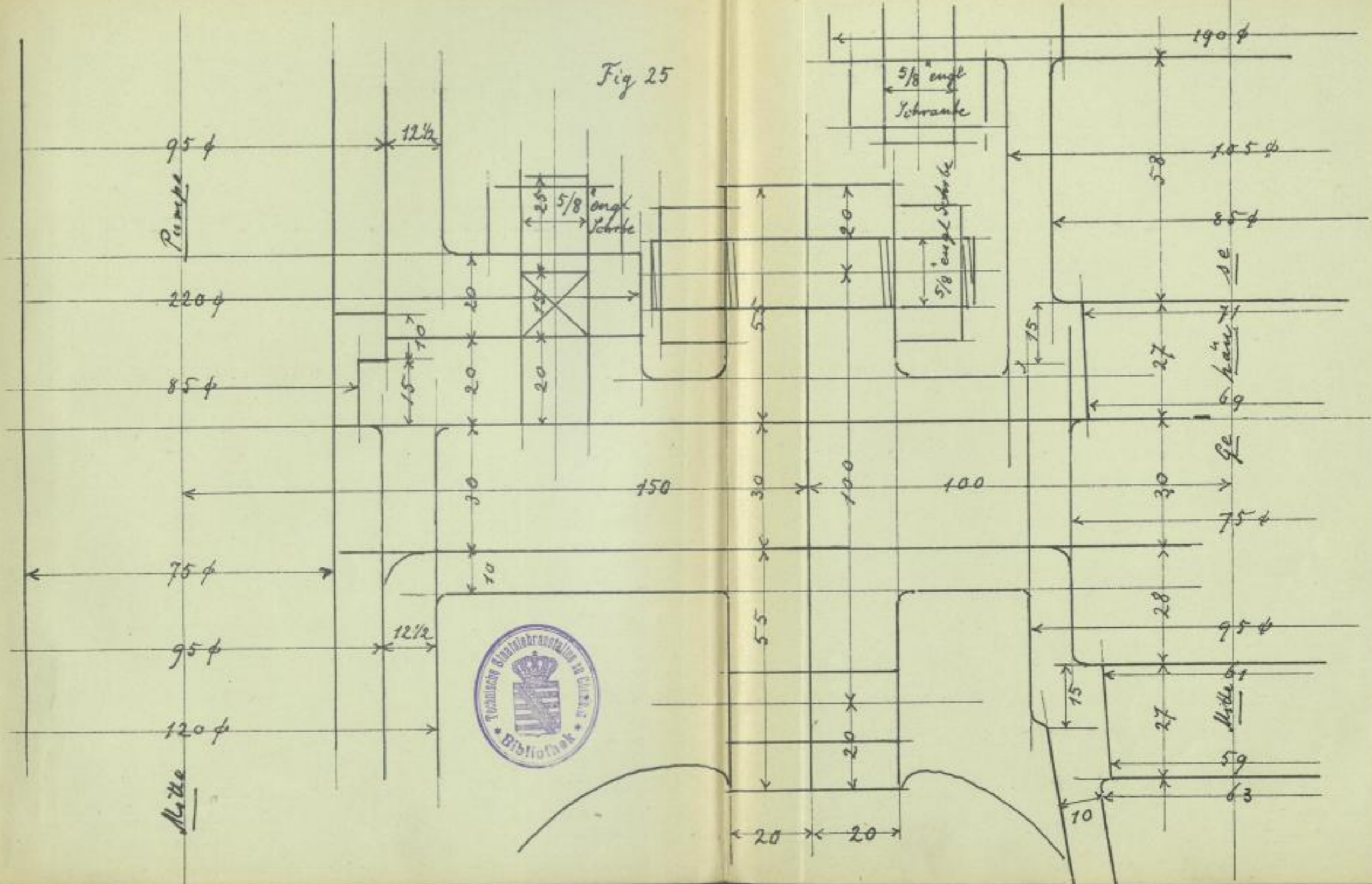

Fig 26
 $\frac{1}{2}$ nat. Gr

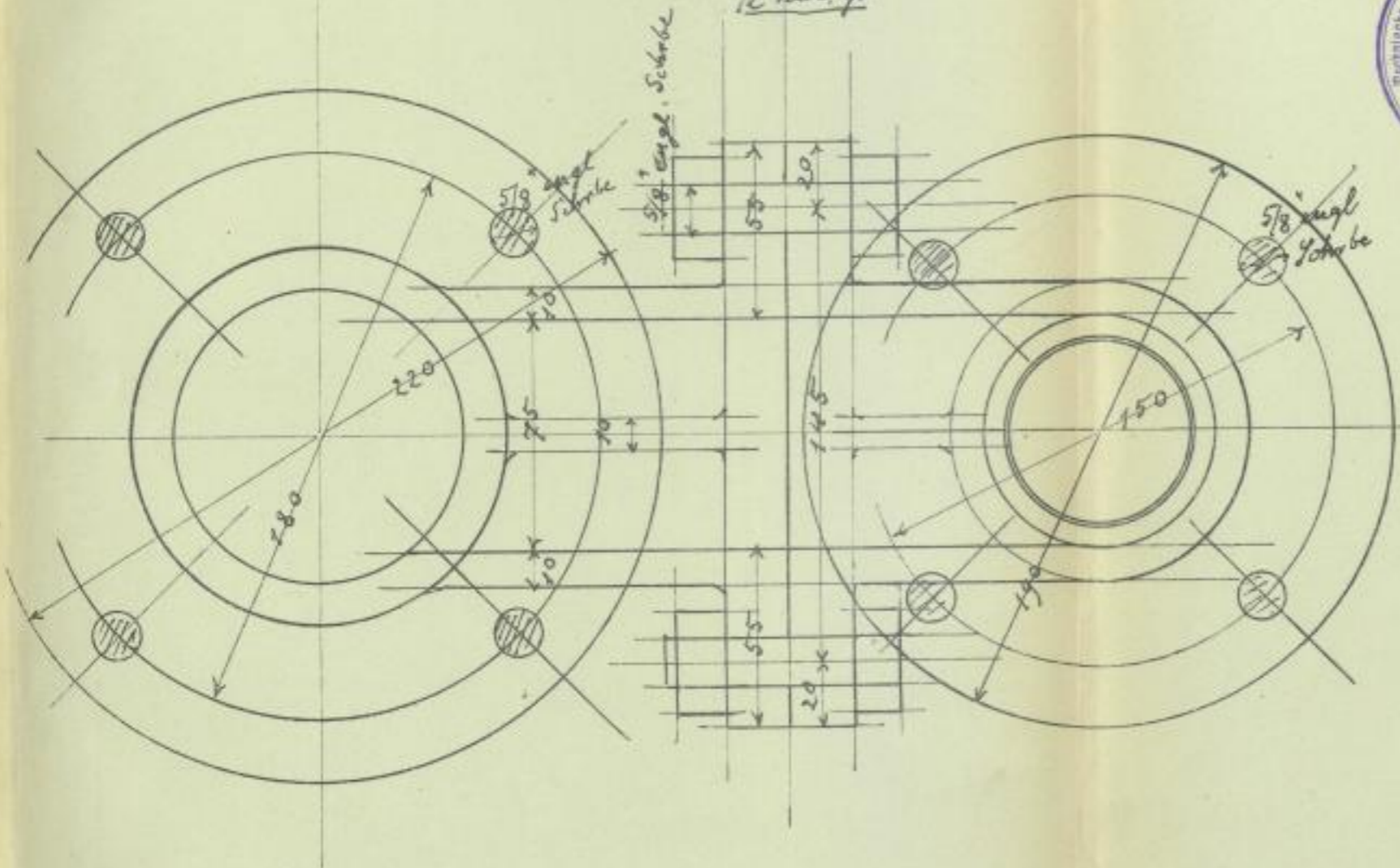

Fig 27.

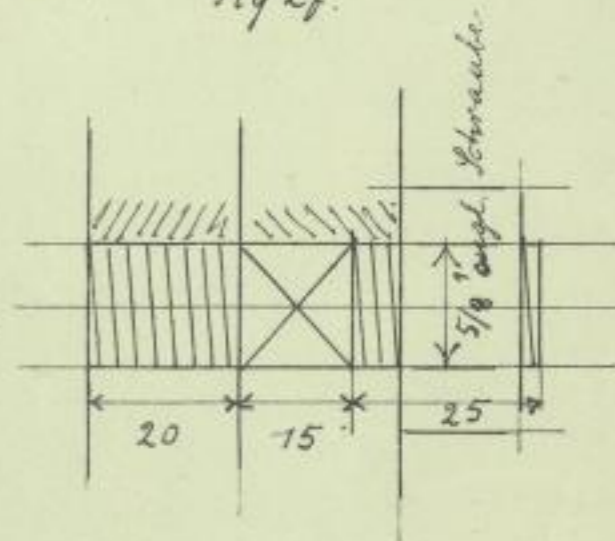
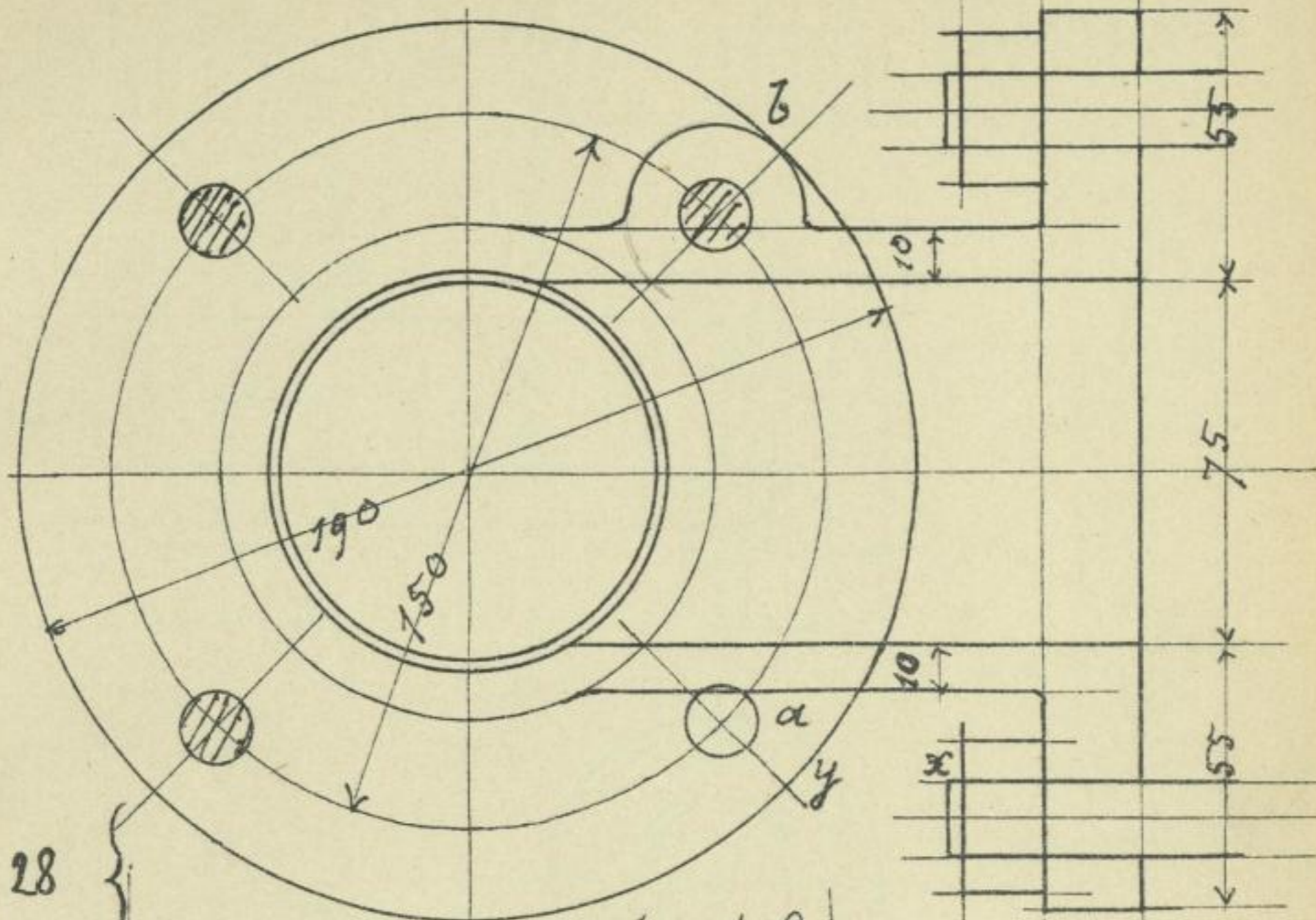
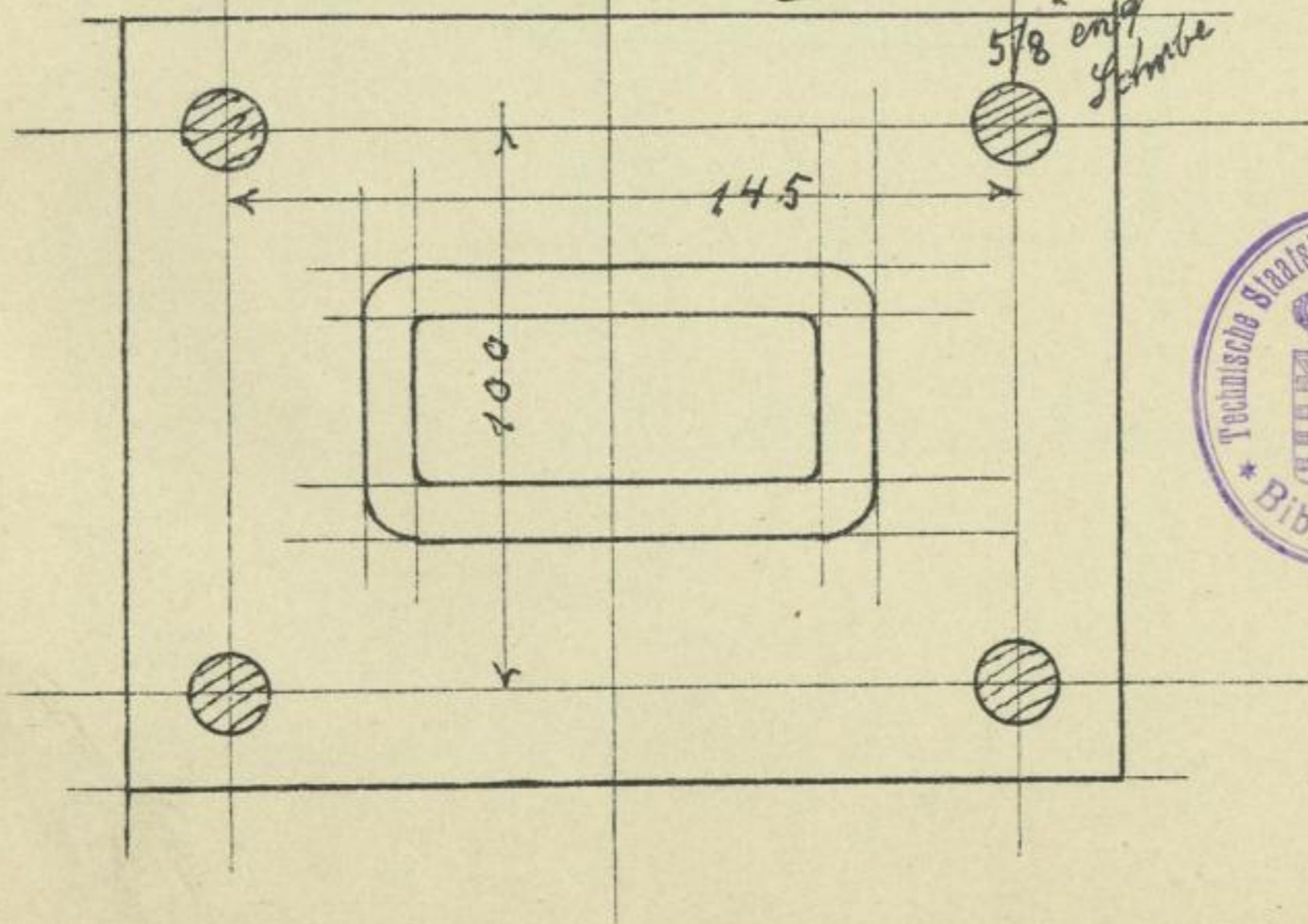

Fig 28



$\frac{1}{2}$ nat. Gr

$\frac{5}{8}$ engl. Schraube



Schnitt UV

Schnitt WZ

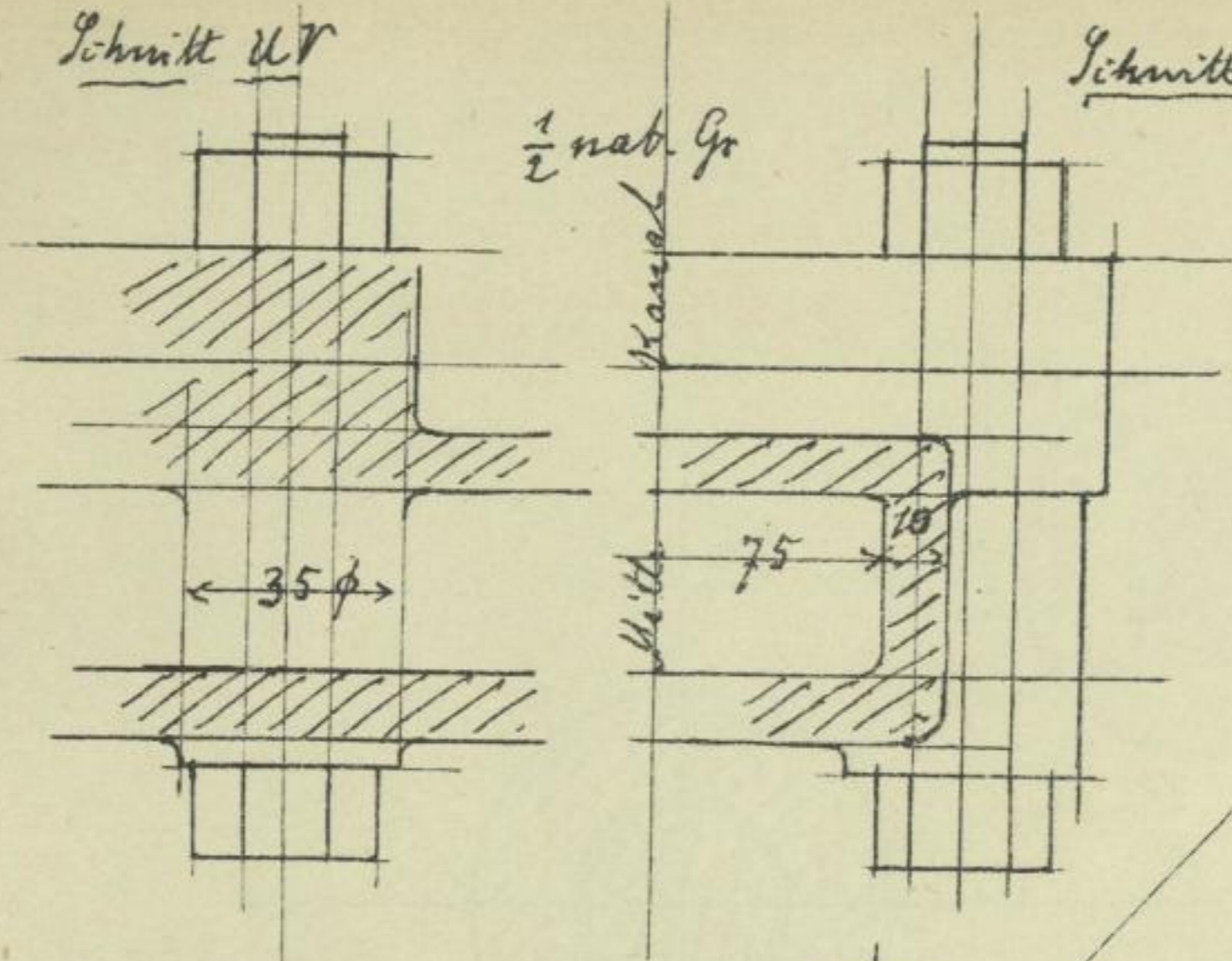
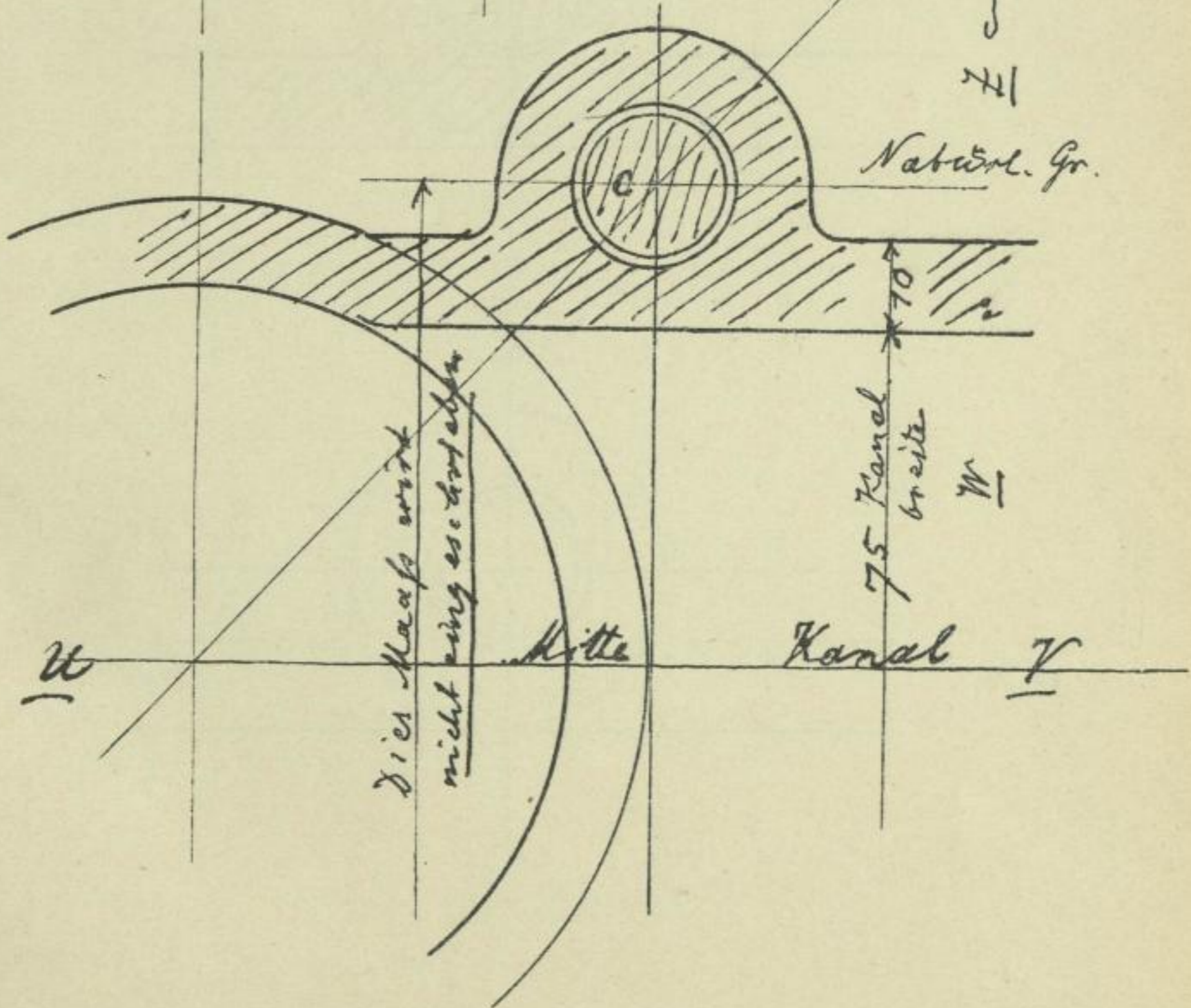

Fig 29



5.11.1887

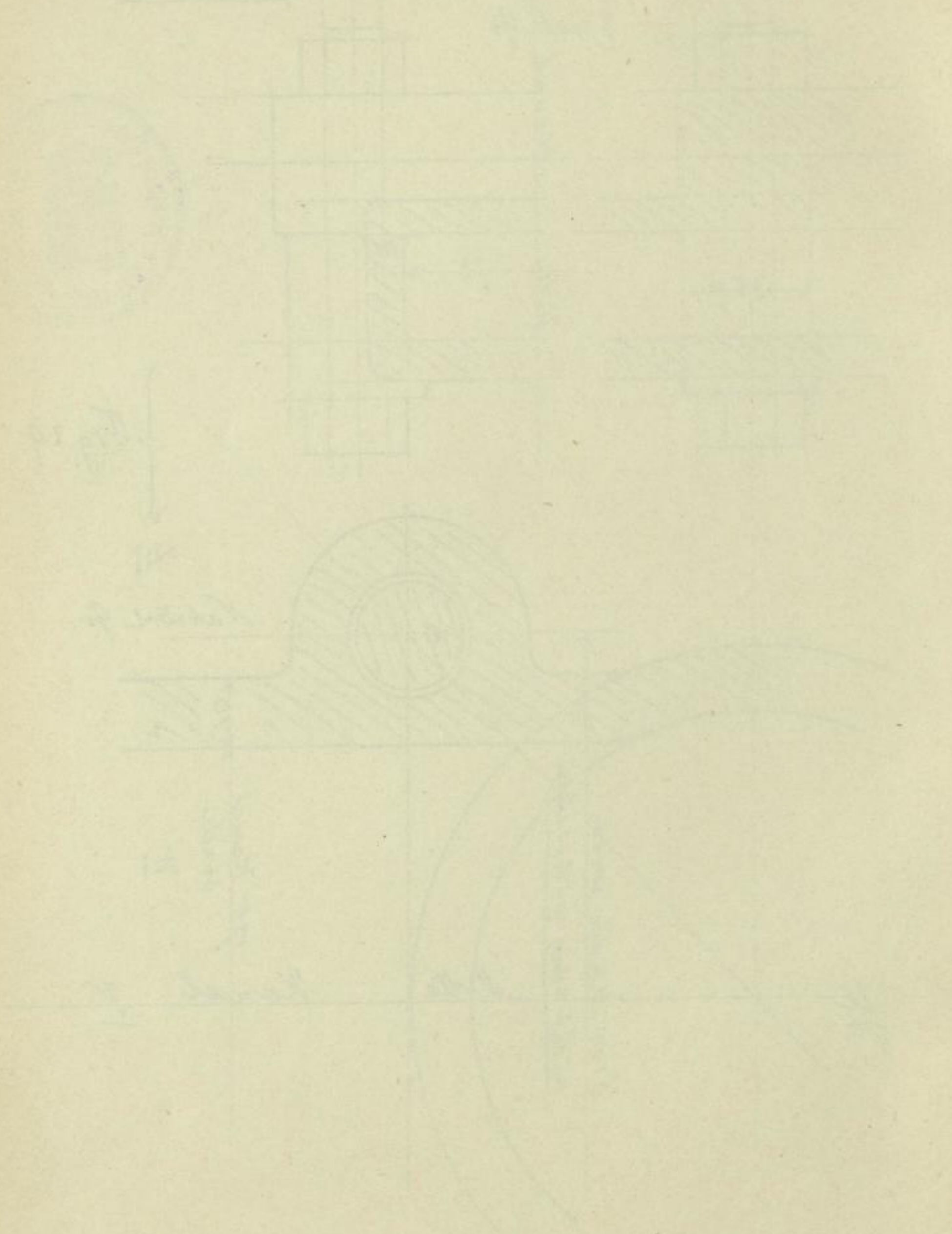

Fig 30

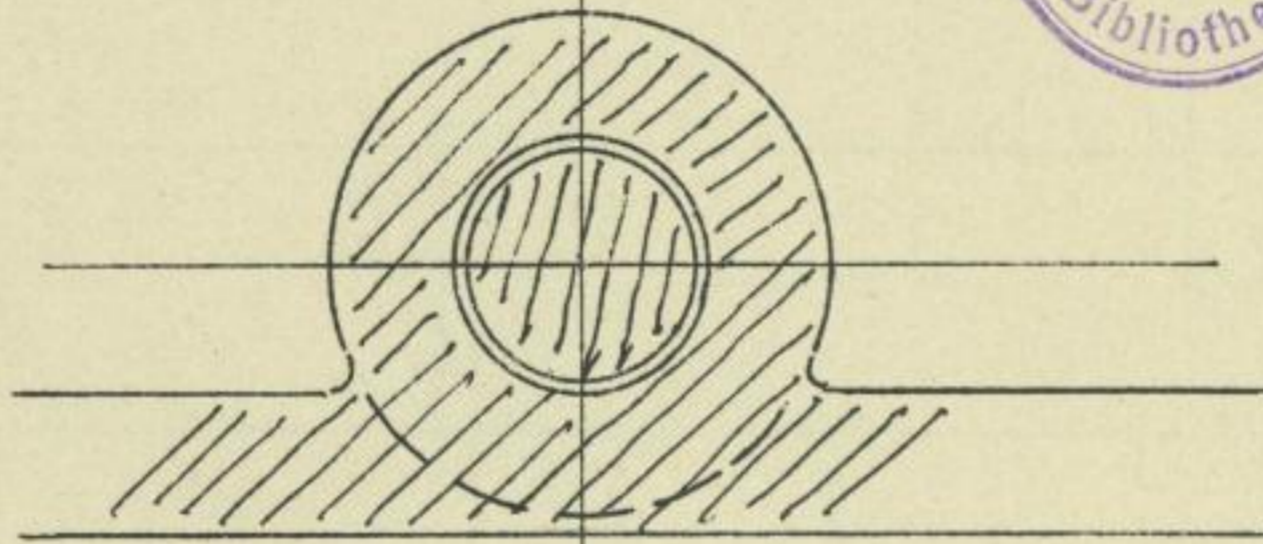

Fig 31

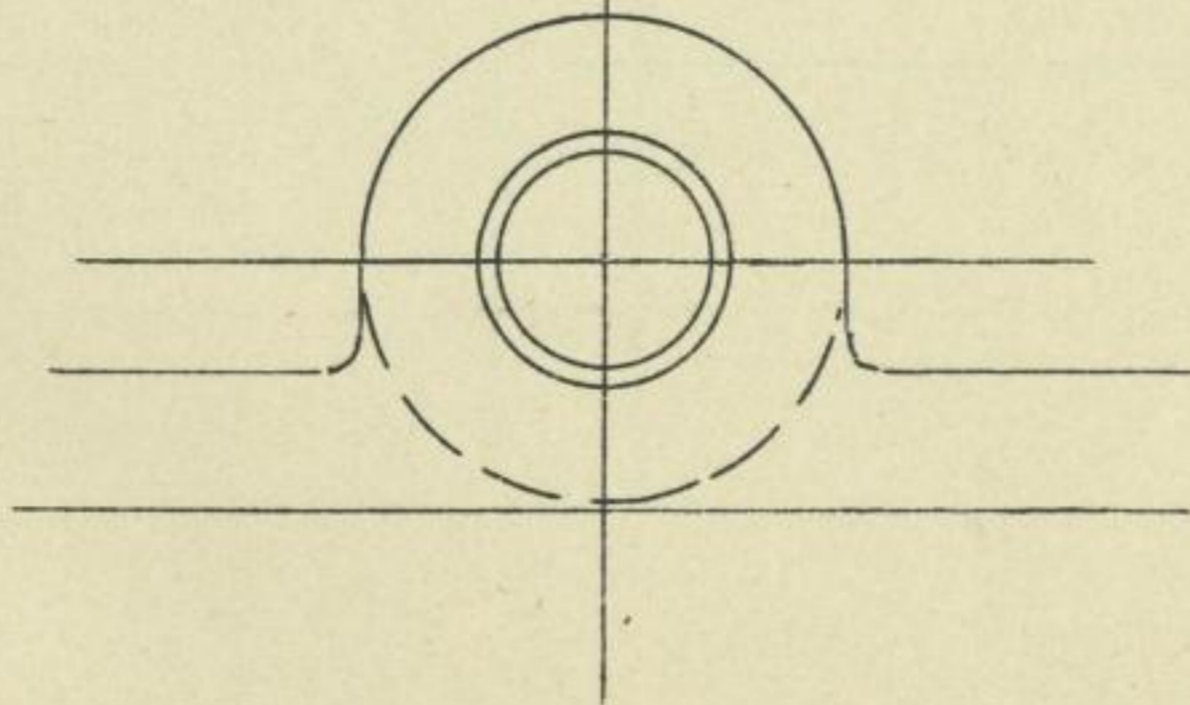
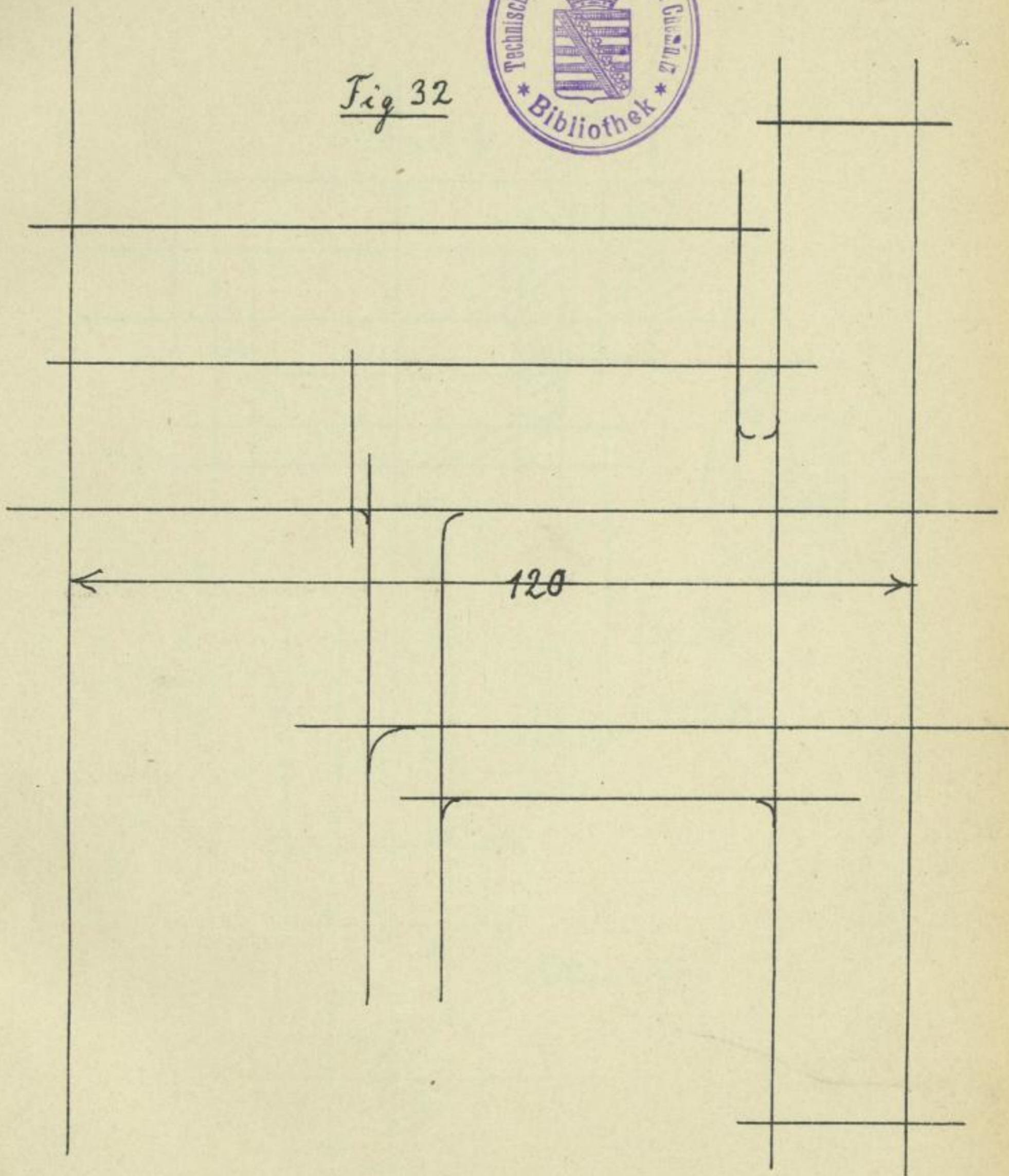

Fig 32



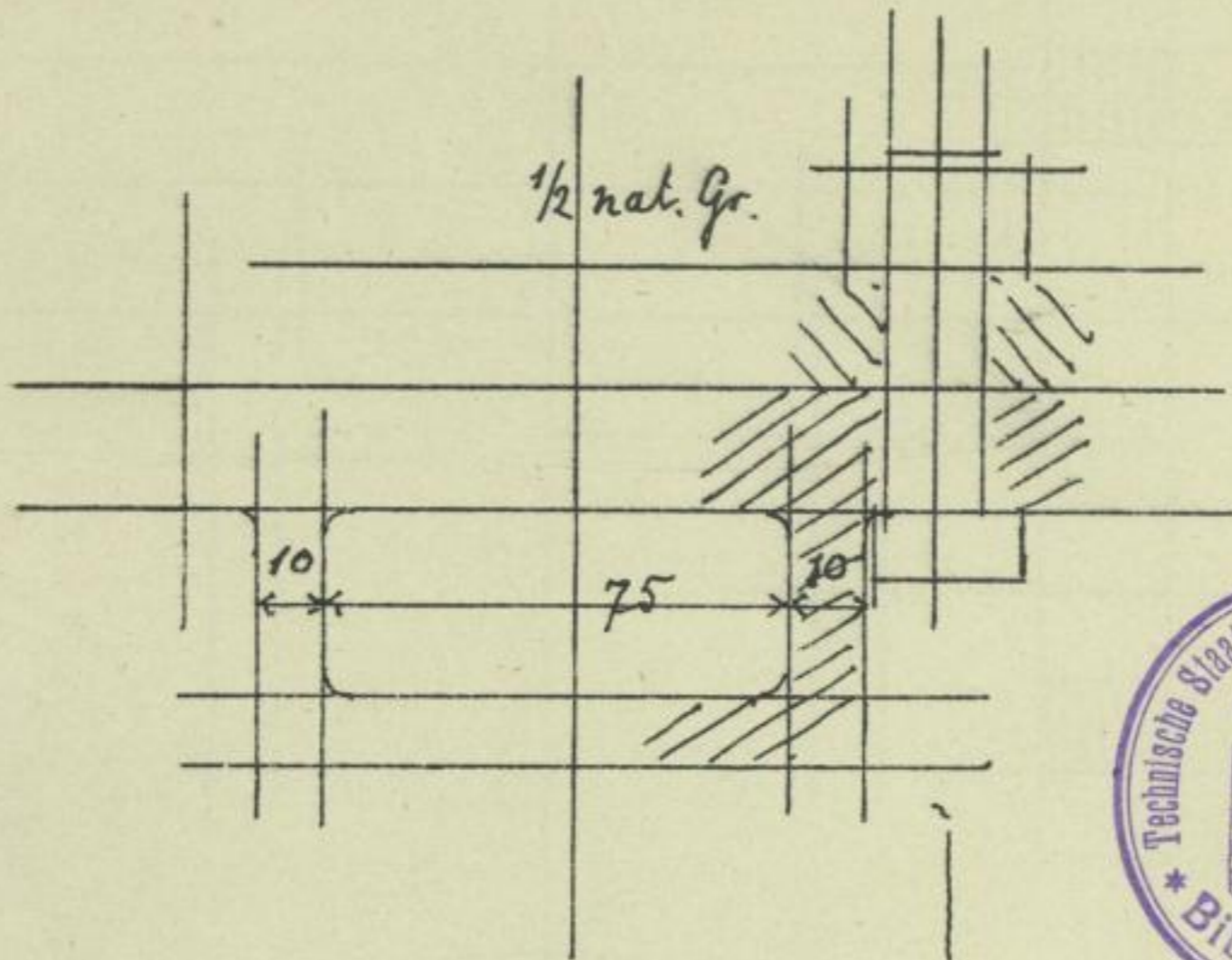
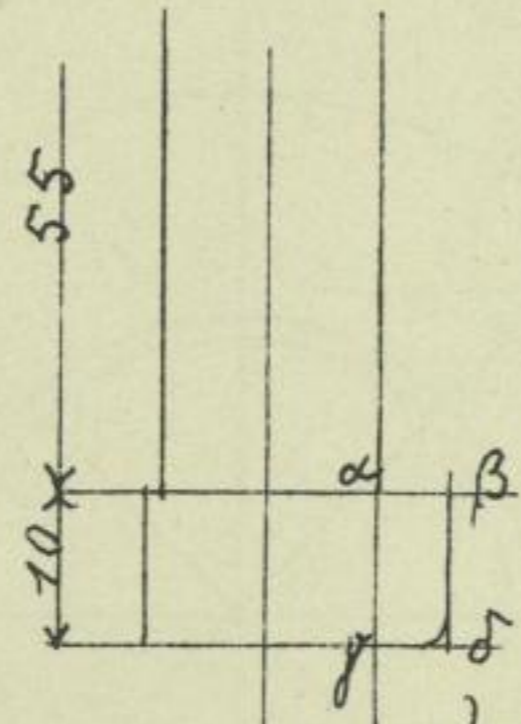
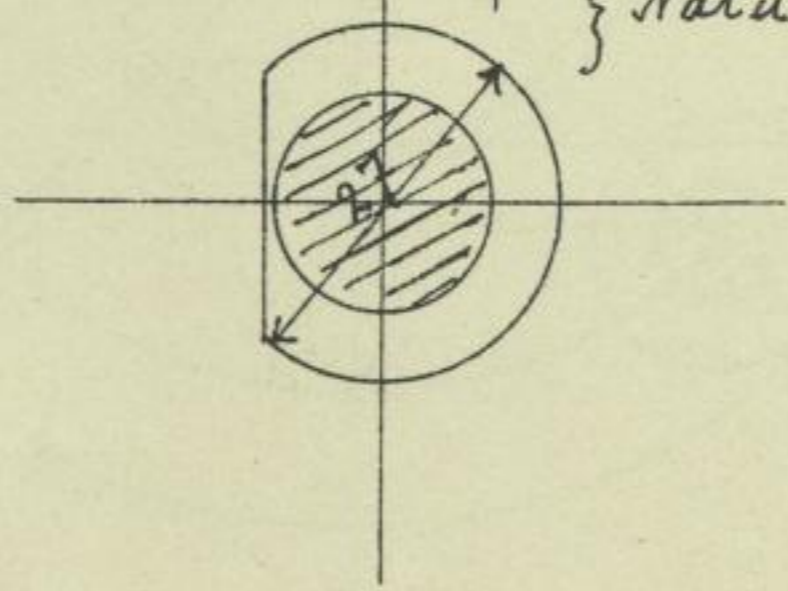

Fig 33.

1/2 nat. Gr.



Natürl. Gr.



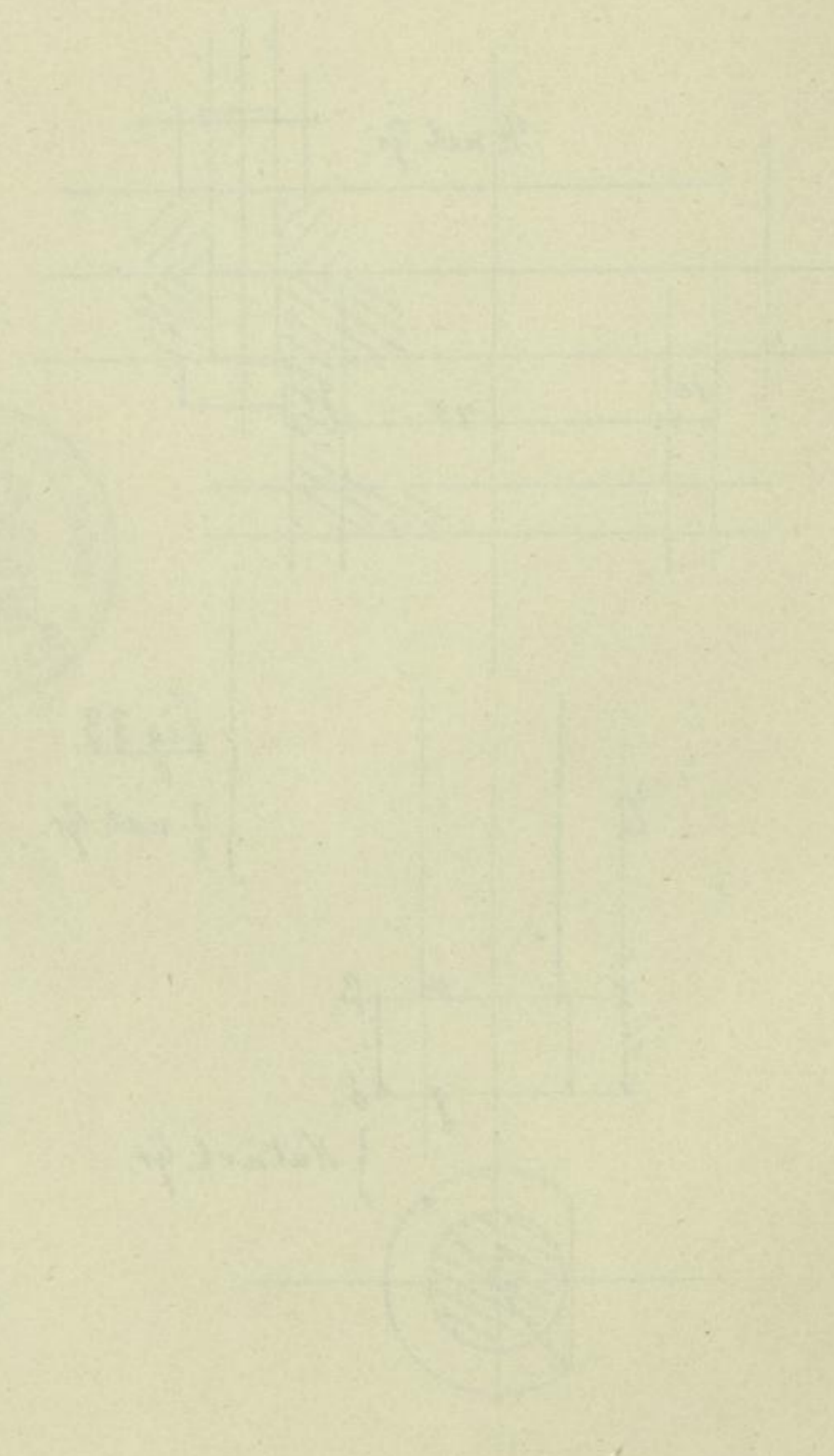

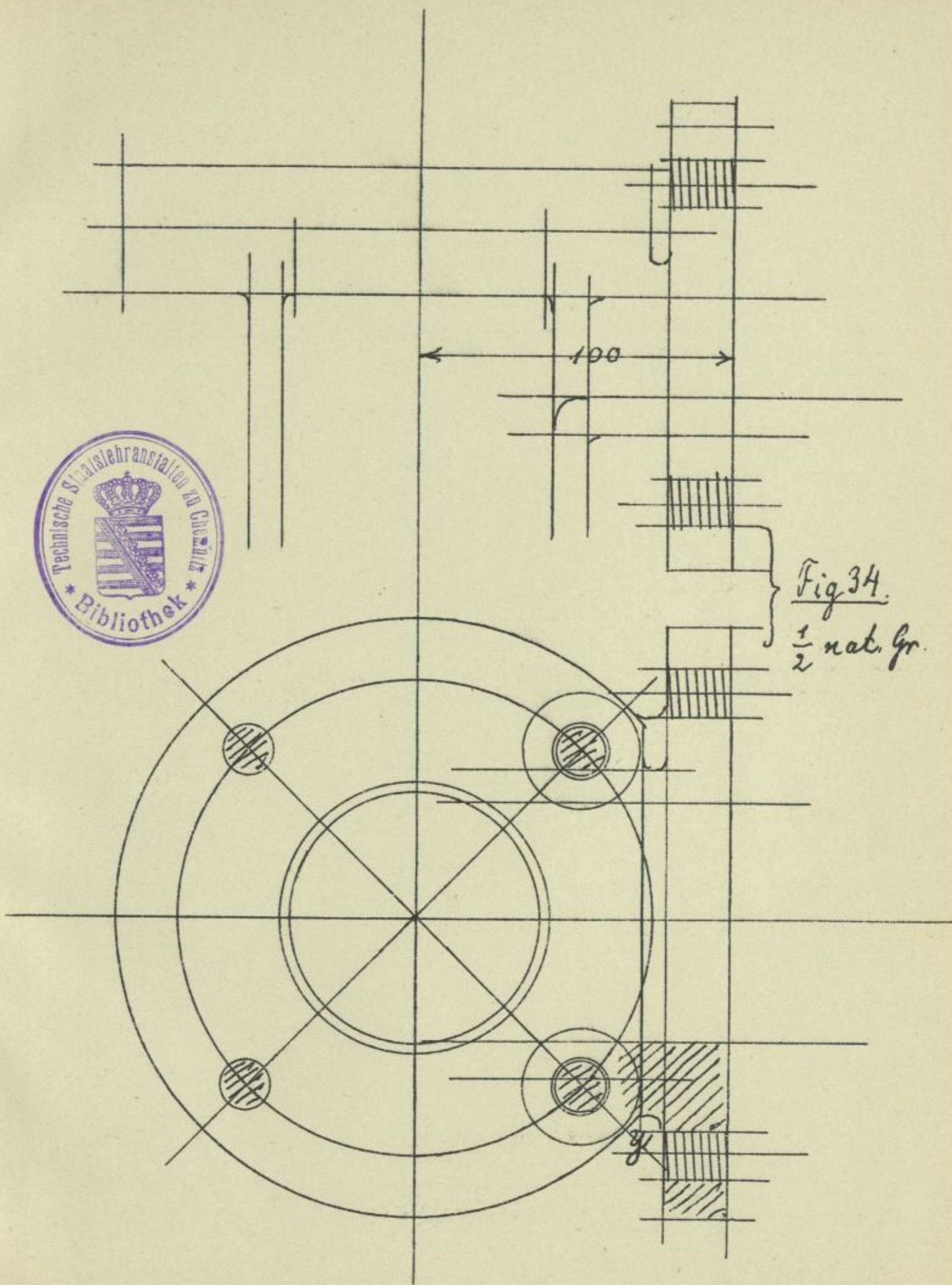
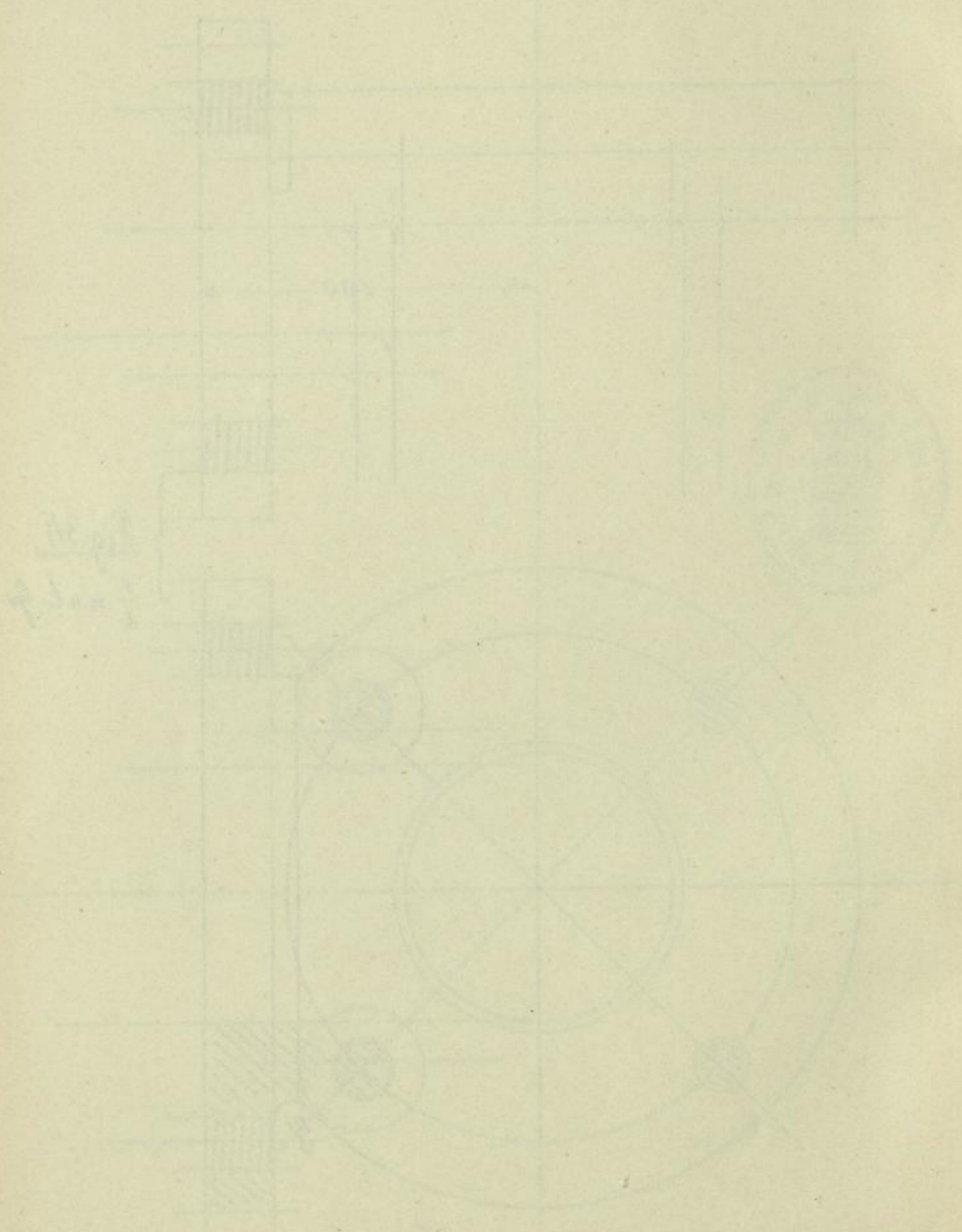

Fig 34.

$\frac{1}{2}$ nat. Gr.



Faint handwritten text, possibly a title or reference number, located in the upper left quadrant of the page.

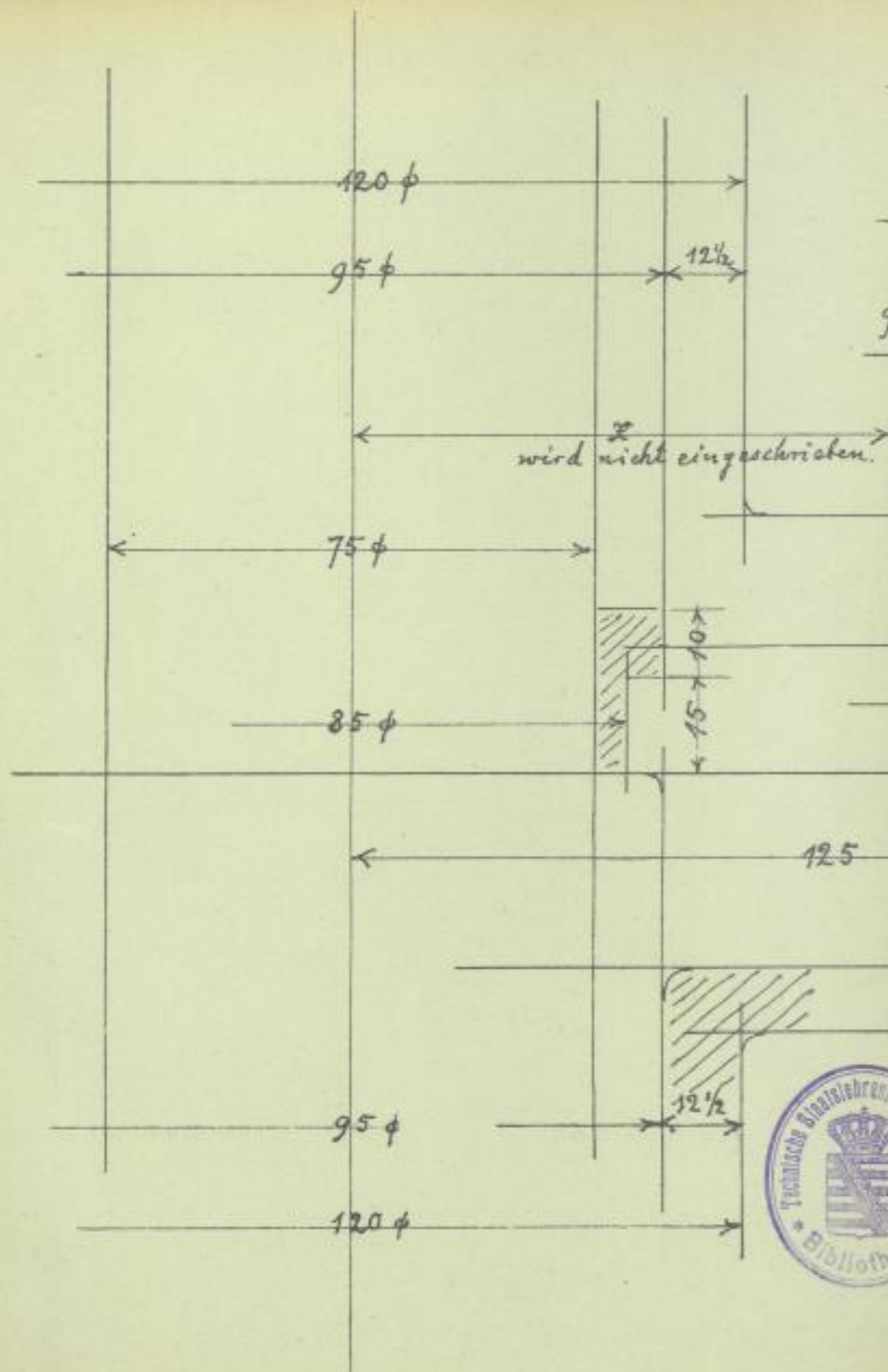

Fig. 35.

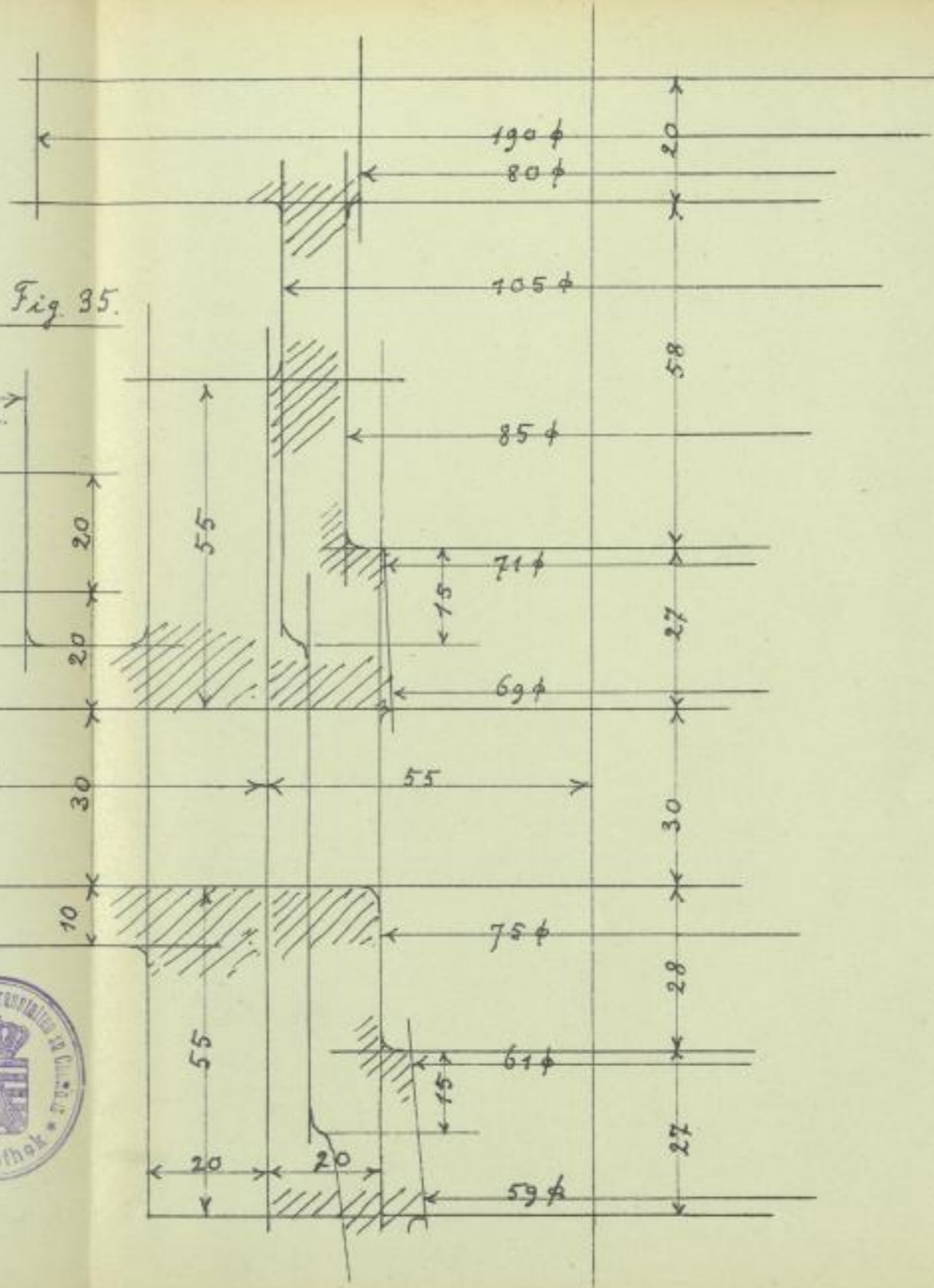

Fig 36.
1/2 nat. Größe

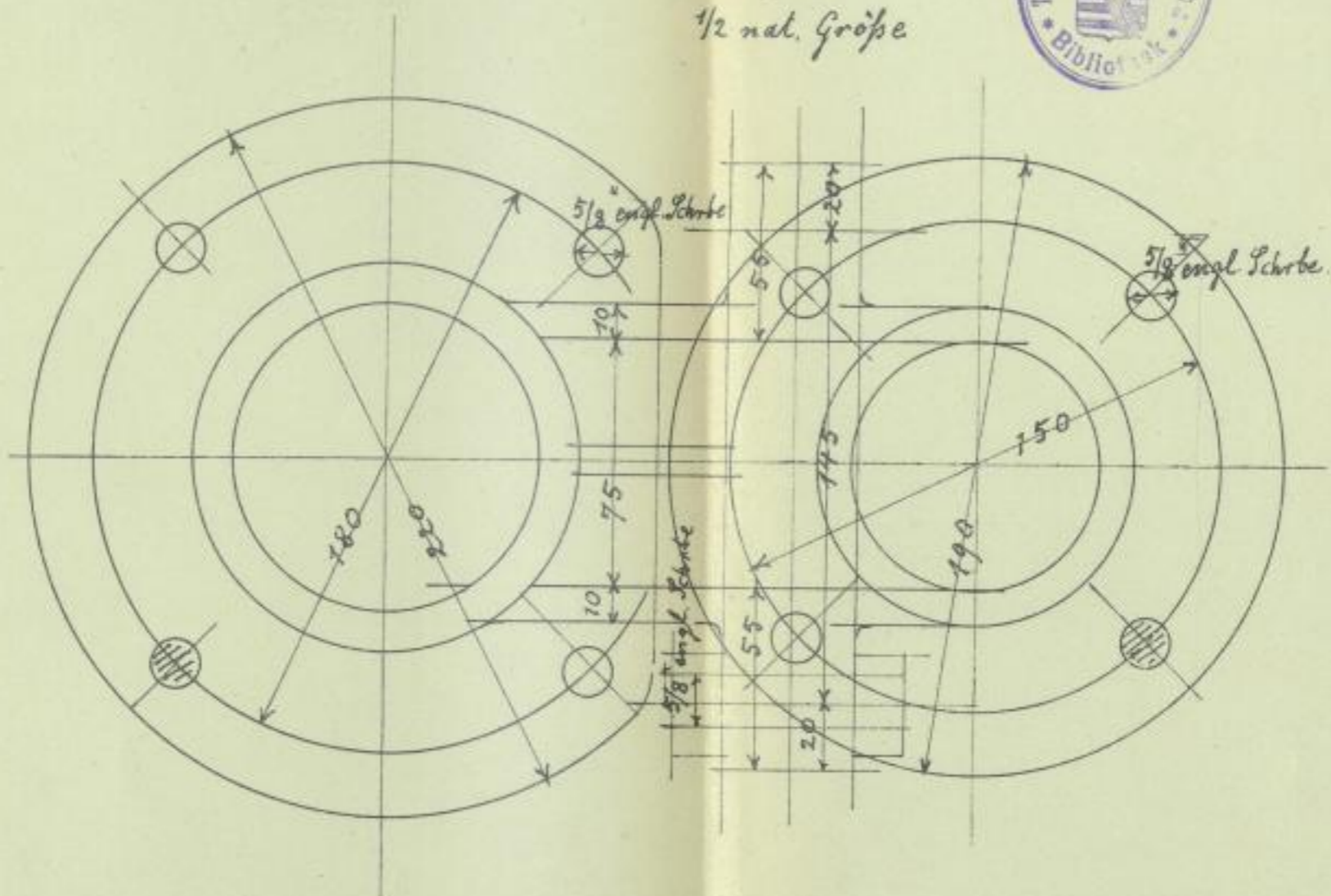
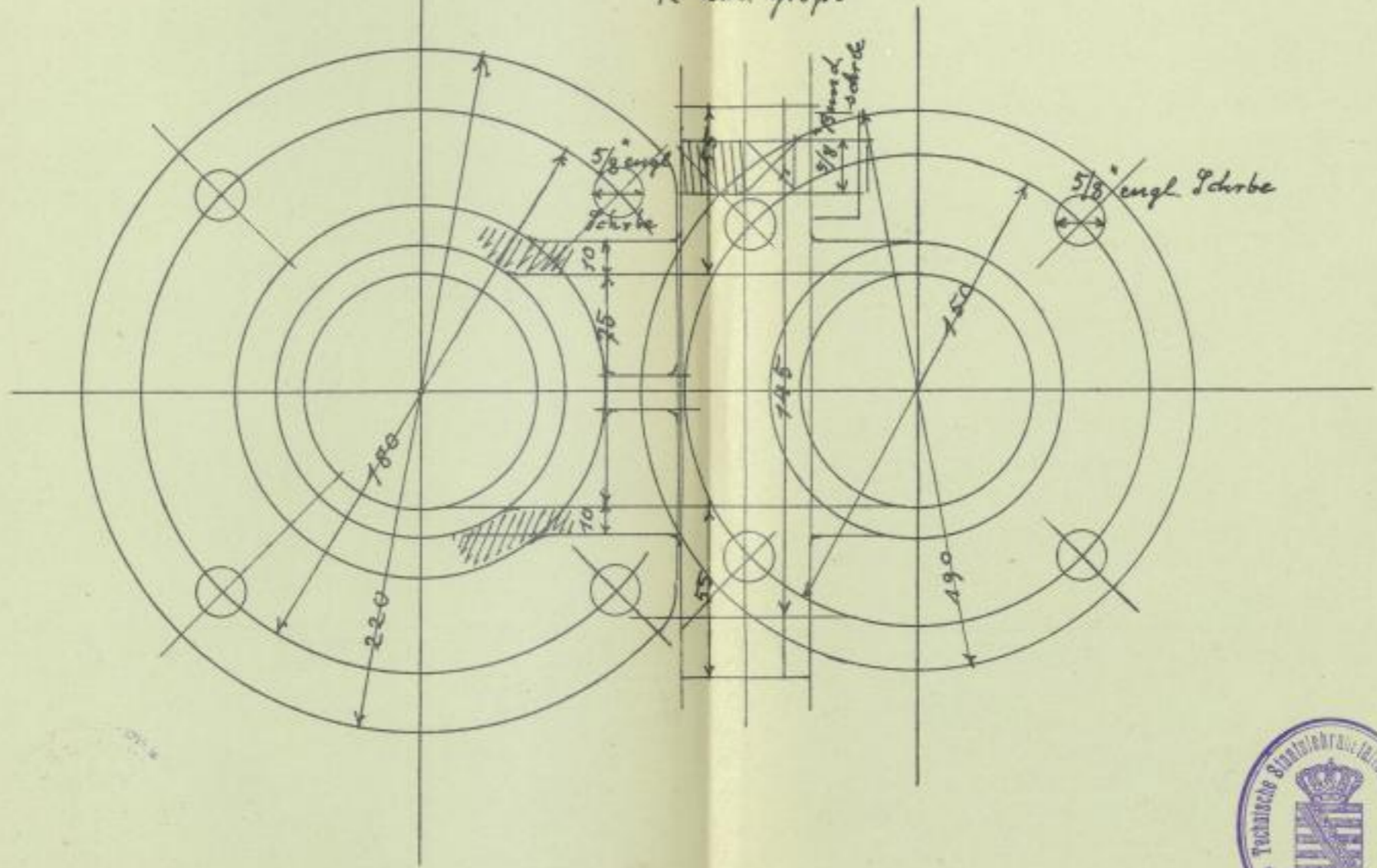
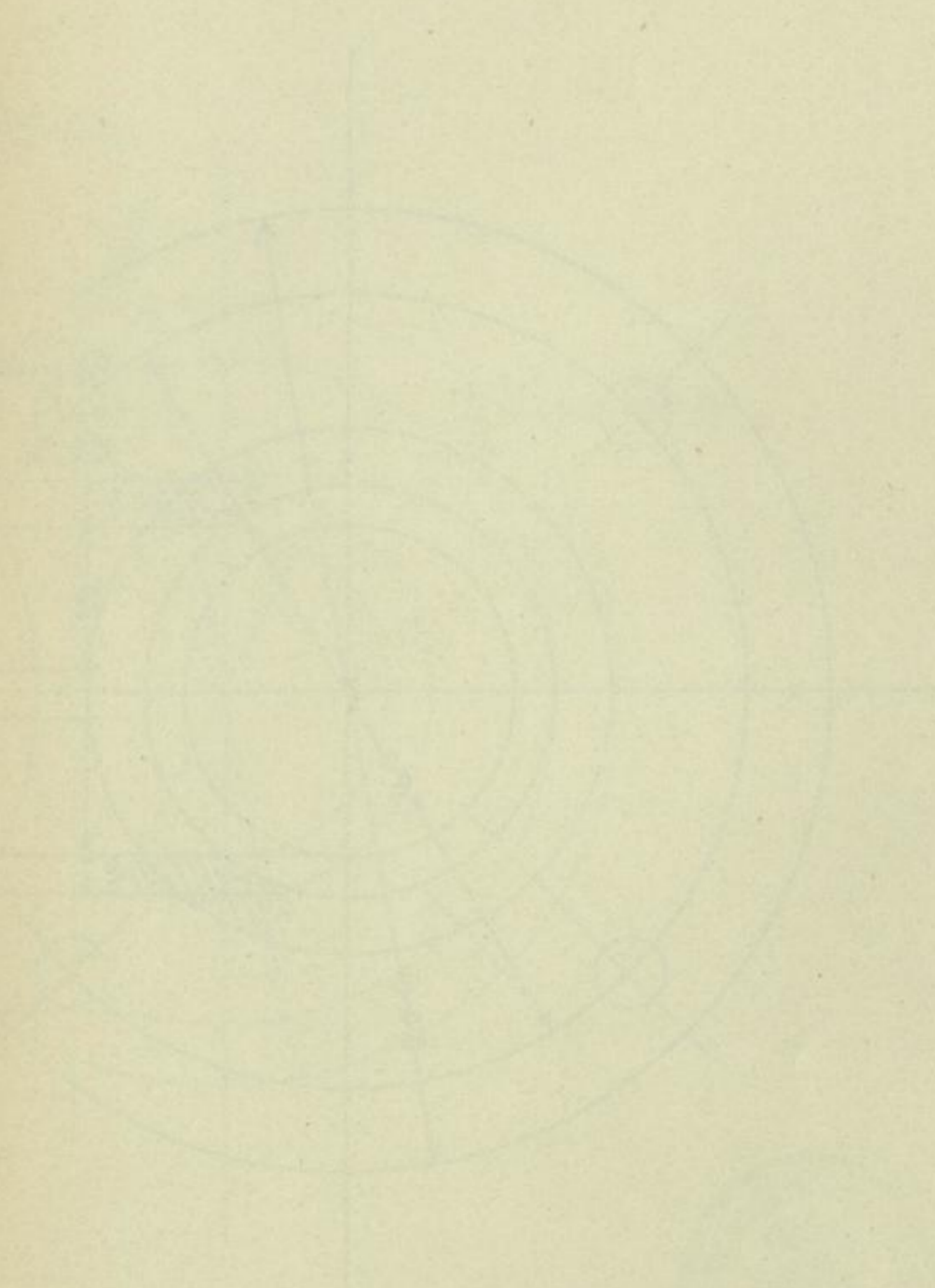

Fig 38
 $\frac{1}{2}$ nat. Größe





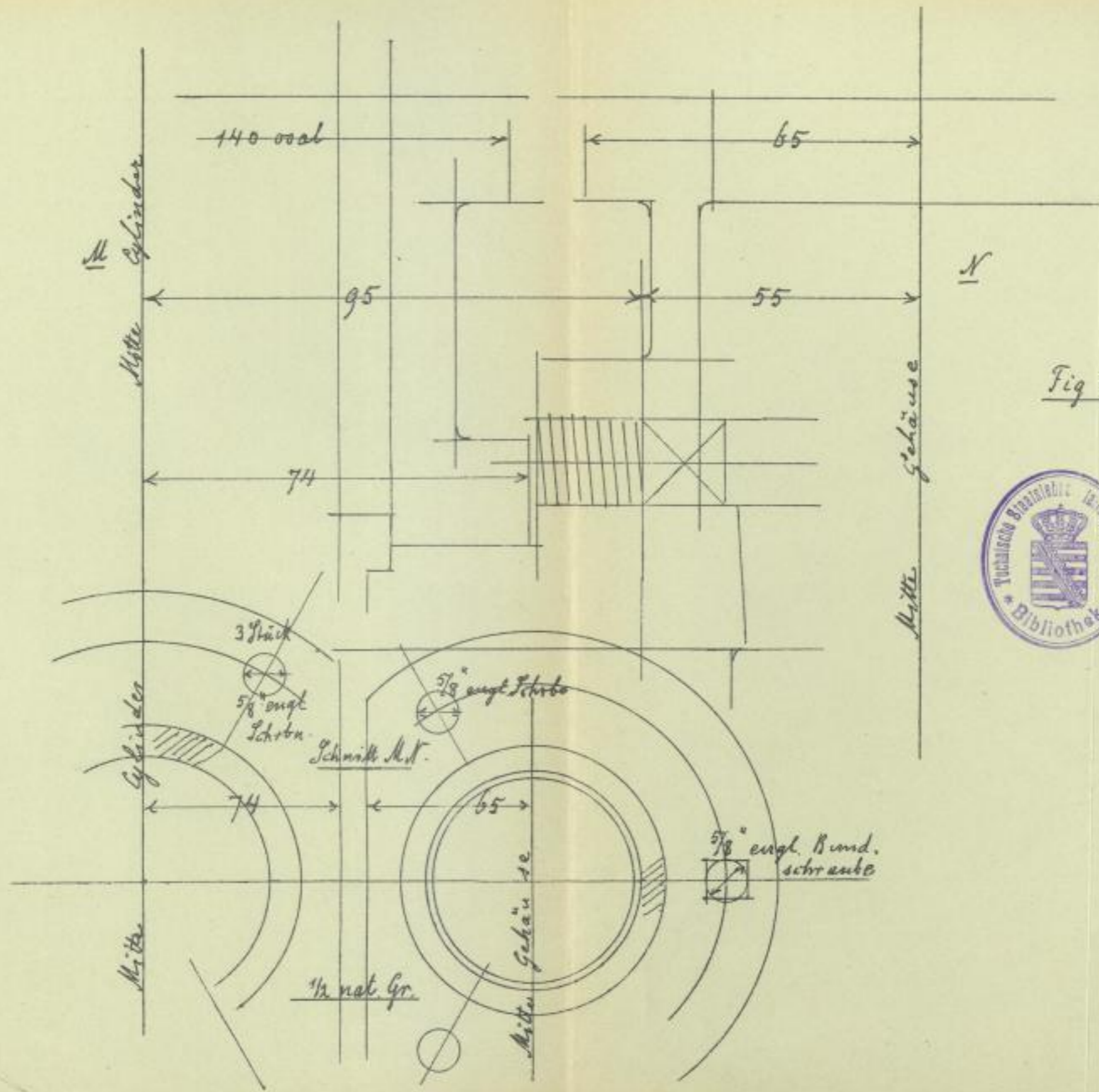

Fig 39.



Fig 40

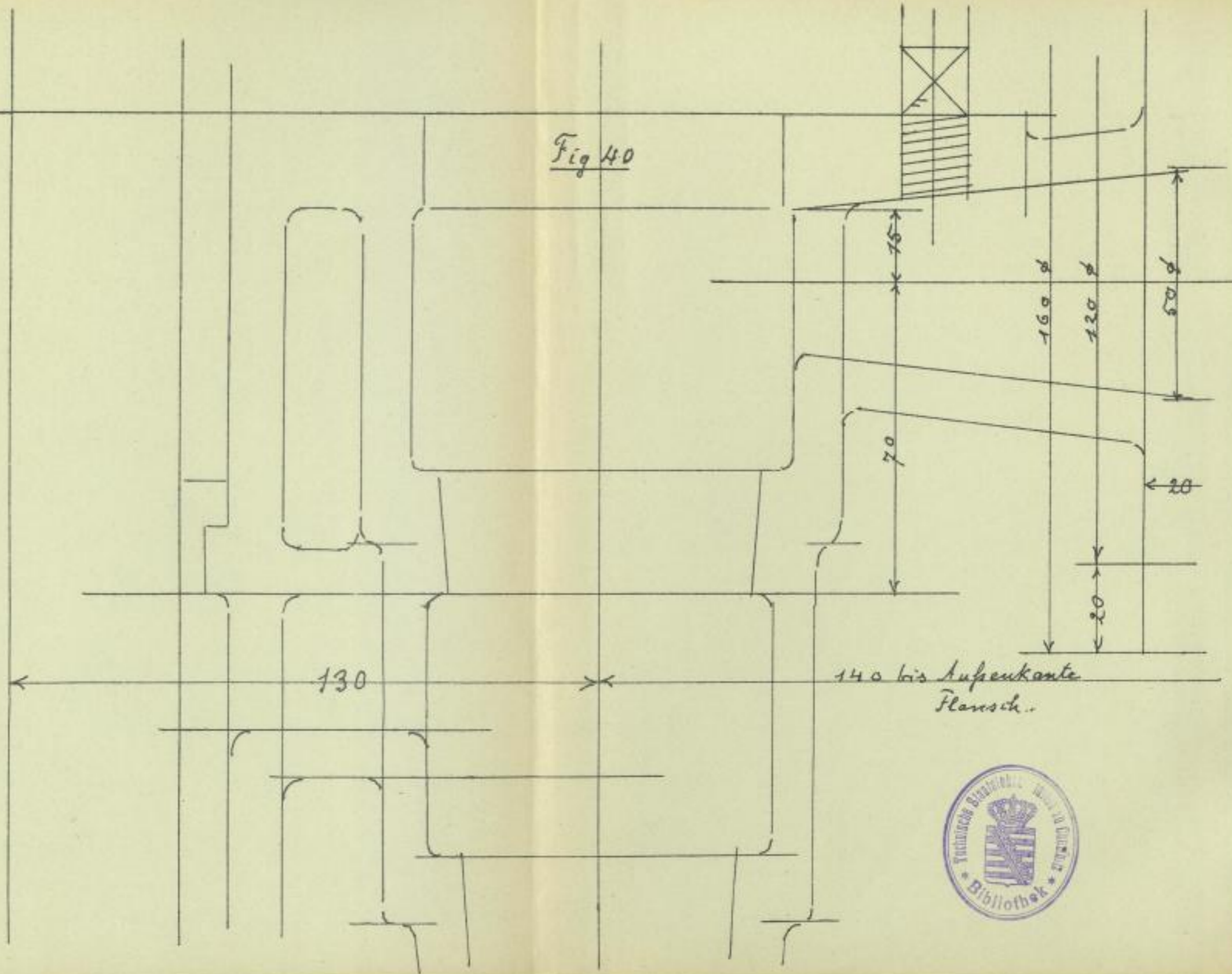
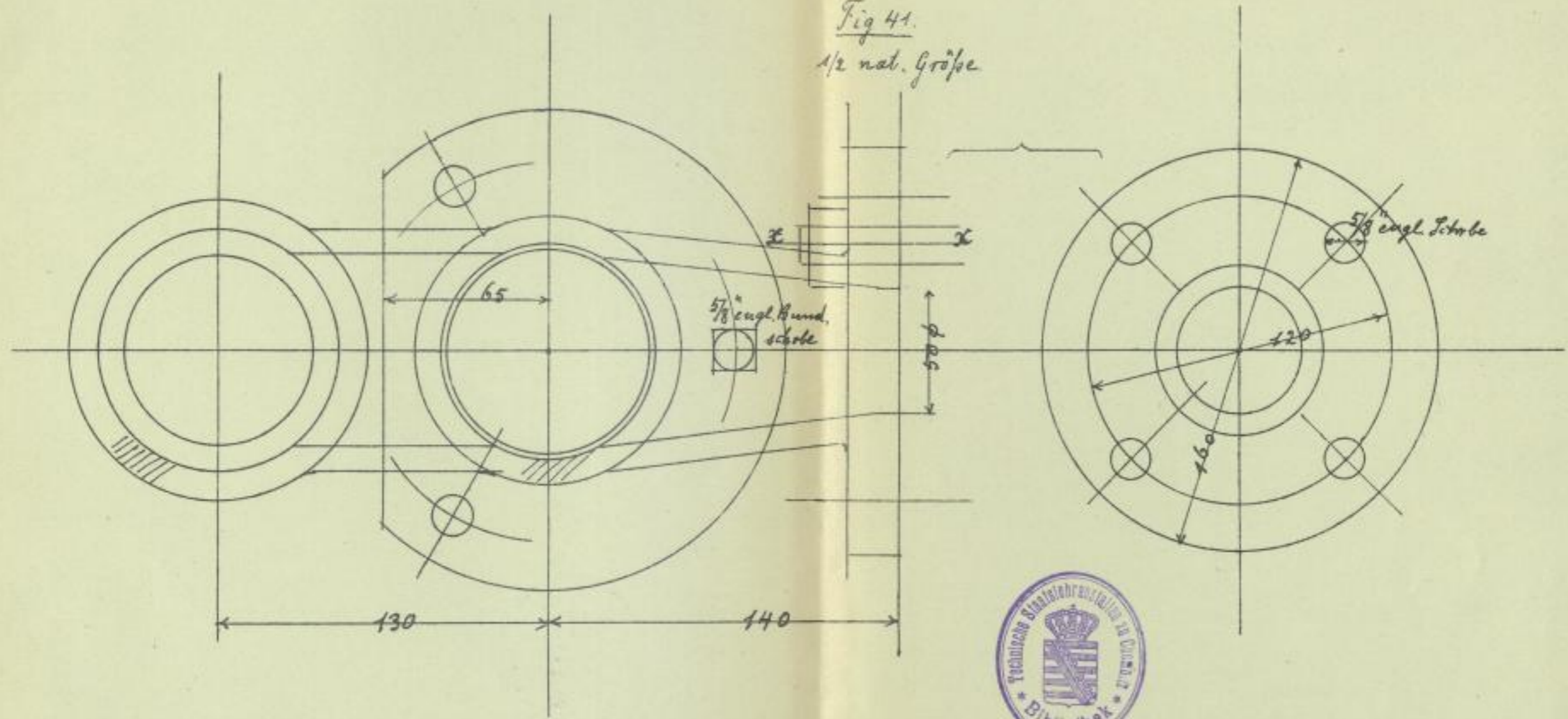

Fig 41.
1/2 nat. Größe



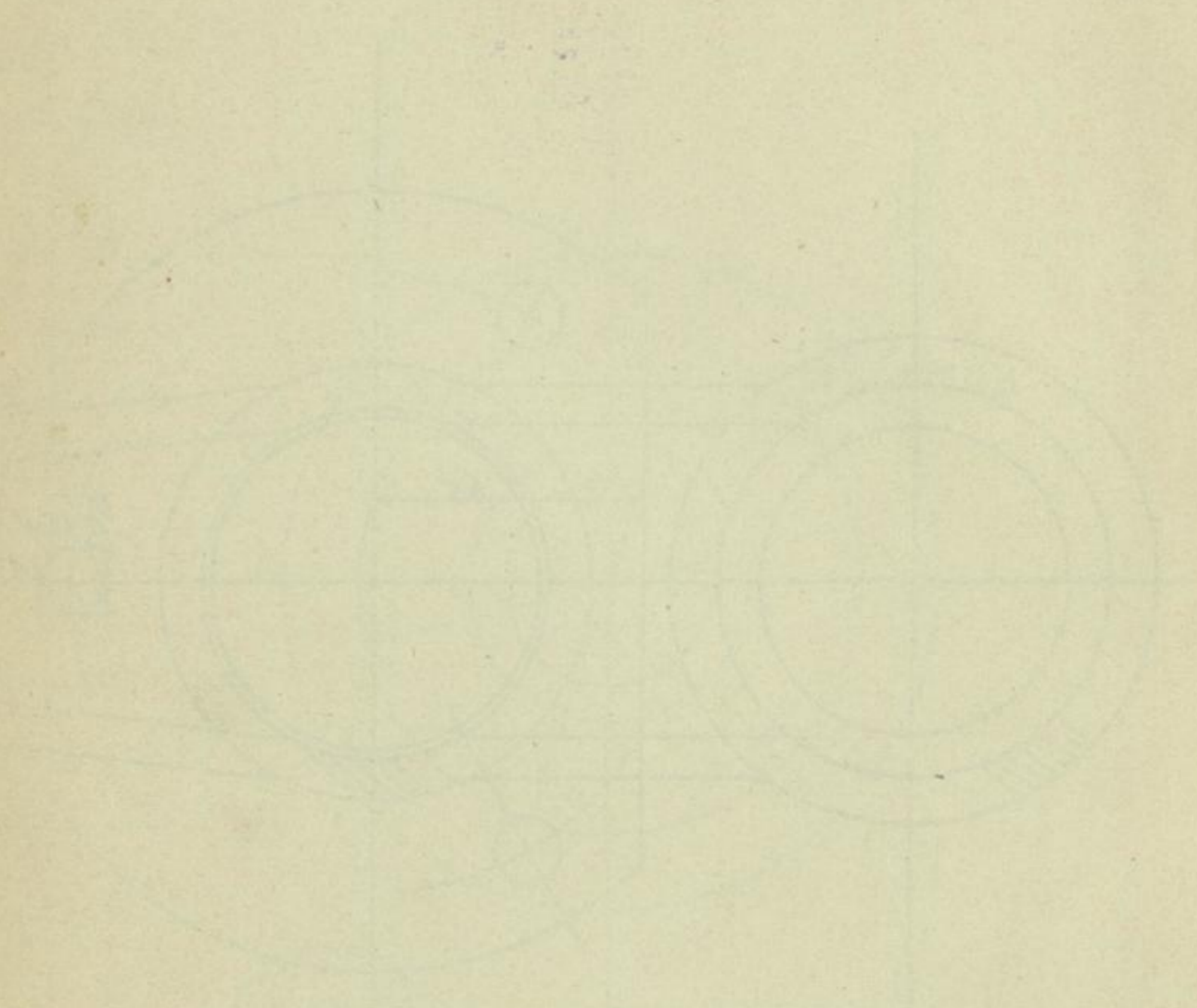



Fig 42

1/5 nat. Gr.

