

ATLAS
ZU
LEMBCKE
MECHANISCHE WEBSTÜHLE
I
SCHAFTSTÜHLE
FÜR GLATTE WAARE



01019856



SLUB

Wir führen Wissen.

<http://digital.slub-dresden.de/id456881794/2>



Westfälische Hochschule Zwickau
Hochschulbibliothek



SLUB

Wir führen Wissen.

<http://digital.slub-dresden.de/id456881794/3>



Westsächsische Hochschule Zwickau
Hochschulbibliothek

4024a

MECHANISCHE WEBSTÜHLE.

ANLEITUNG

ZUR

KENNTNISS, WAHL, AUFSTELLUNG UND BEHANDLUNG
DIESER MASCHINEN.

VON

E. R. LEMBCKE,

Ingenieur und Director der Königlichen Webe-Färberei- und Appreturschule zu Crefeld, Ritter des Königlichen
Preussischen Rothen-Adler-Ordens IV. Classe.

FORTSETZUNG II.

ATLAS.

BRAUNSCHWEIG,

DRUCK UND VERLAG VON FRIEDRICH VIEWEG UND SOHN.

1890.

MICHAELIS

1871

VERLAG VON MICHAELIS

DIESE

Alle Rechte vorbehalten.

F. M. MICHAELIS

IN

LEIPZIG

VERLAG

VON MICHAELIS

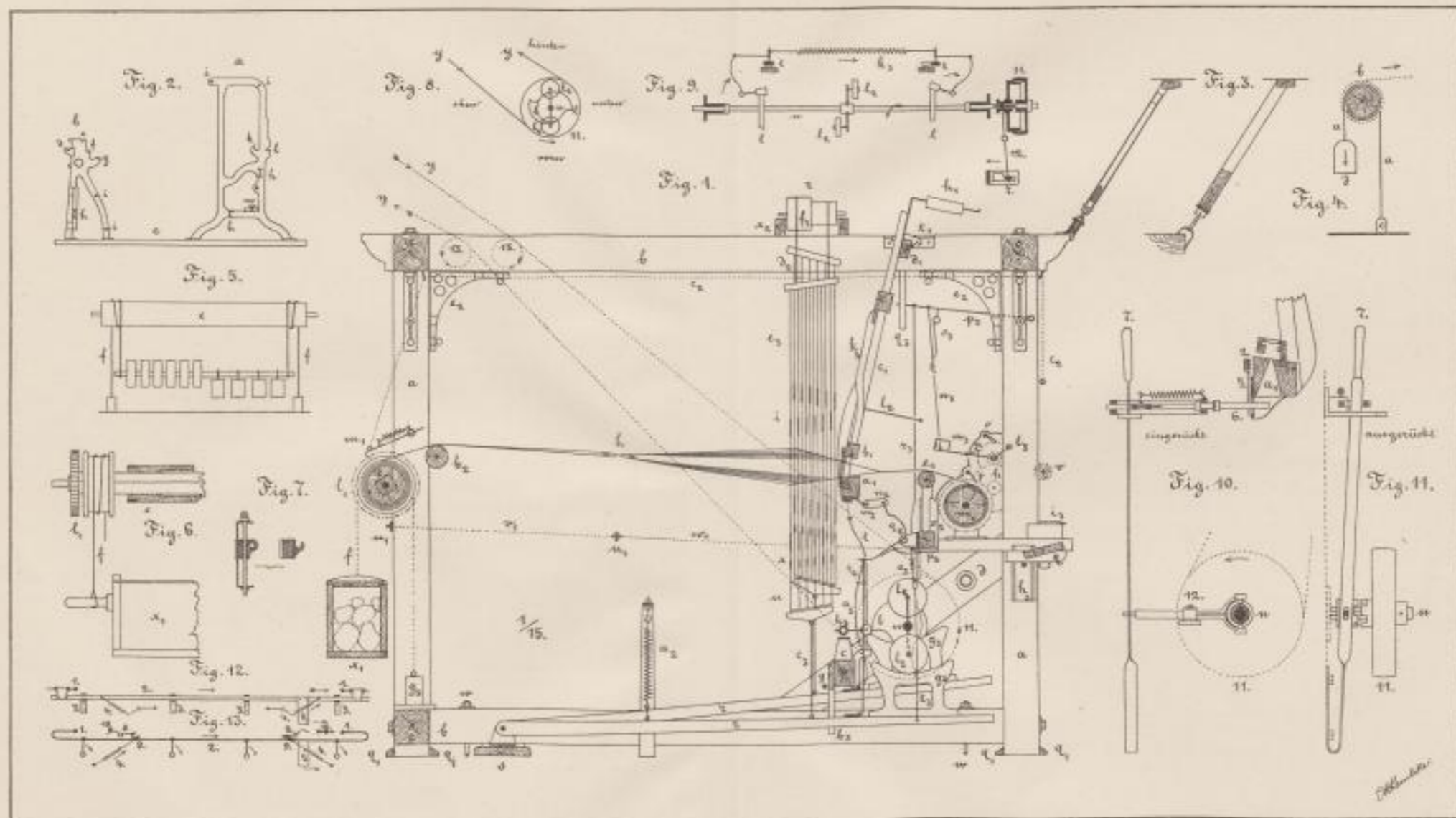

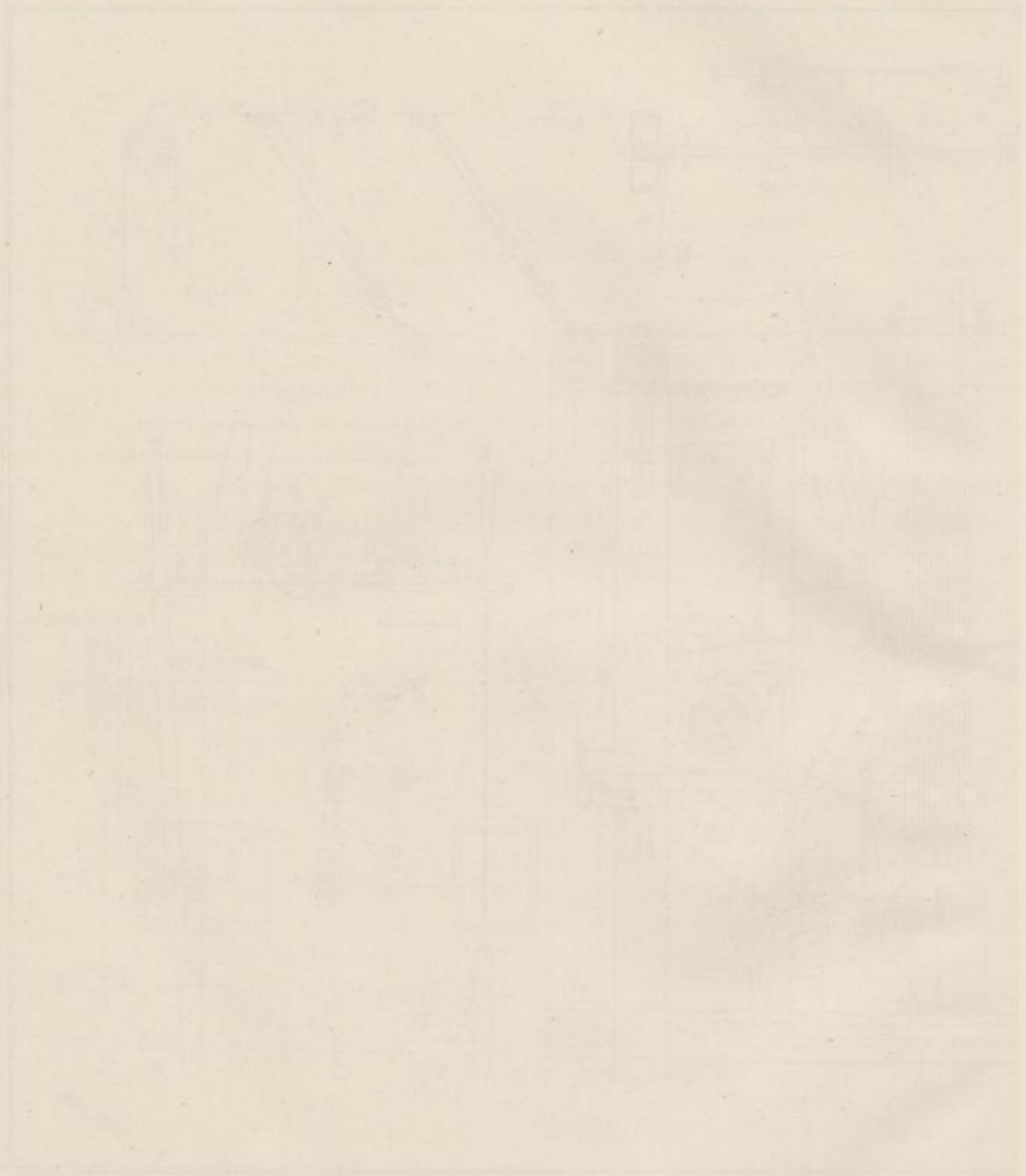

The image shows a page from an old book with a very faint, large rectangular grid or table structure. The grid consists of multiple columns and rows, but the lines are extremely light and difficult to discern against the aged paper background. The overall appearance is that of a ledger or account book page, possibly containing financial or administrative data. The page is otherwise blank, with no text or other markings visible.

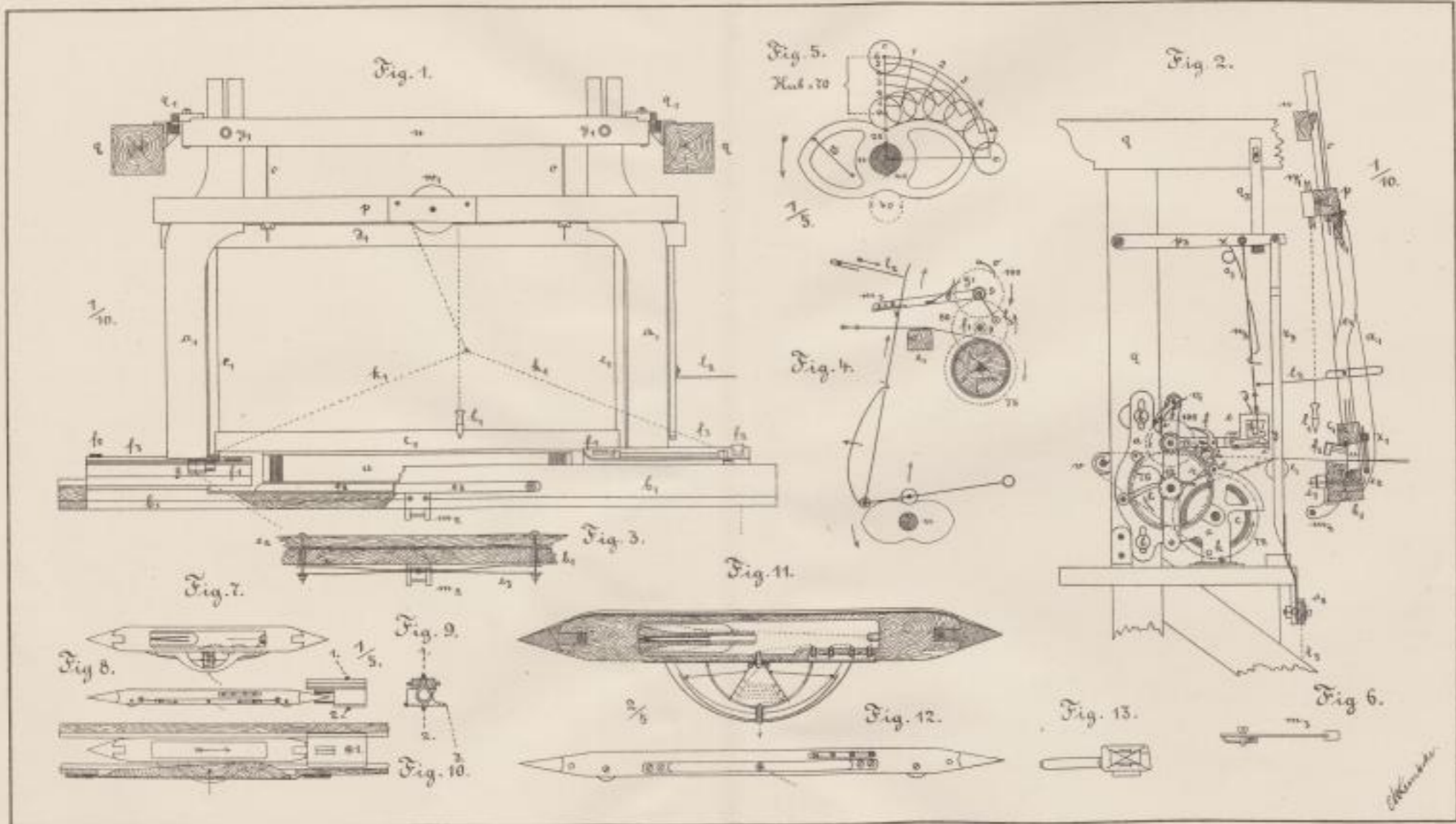

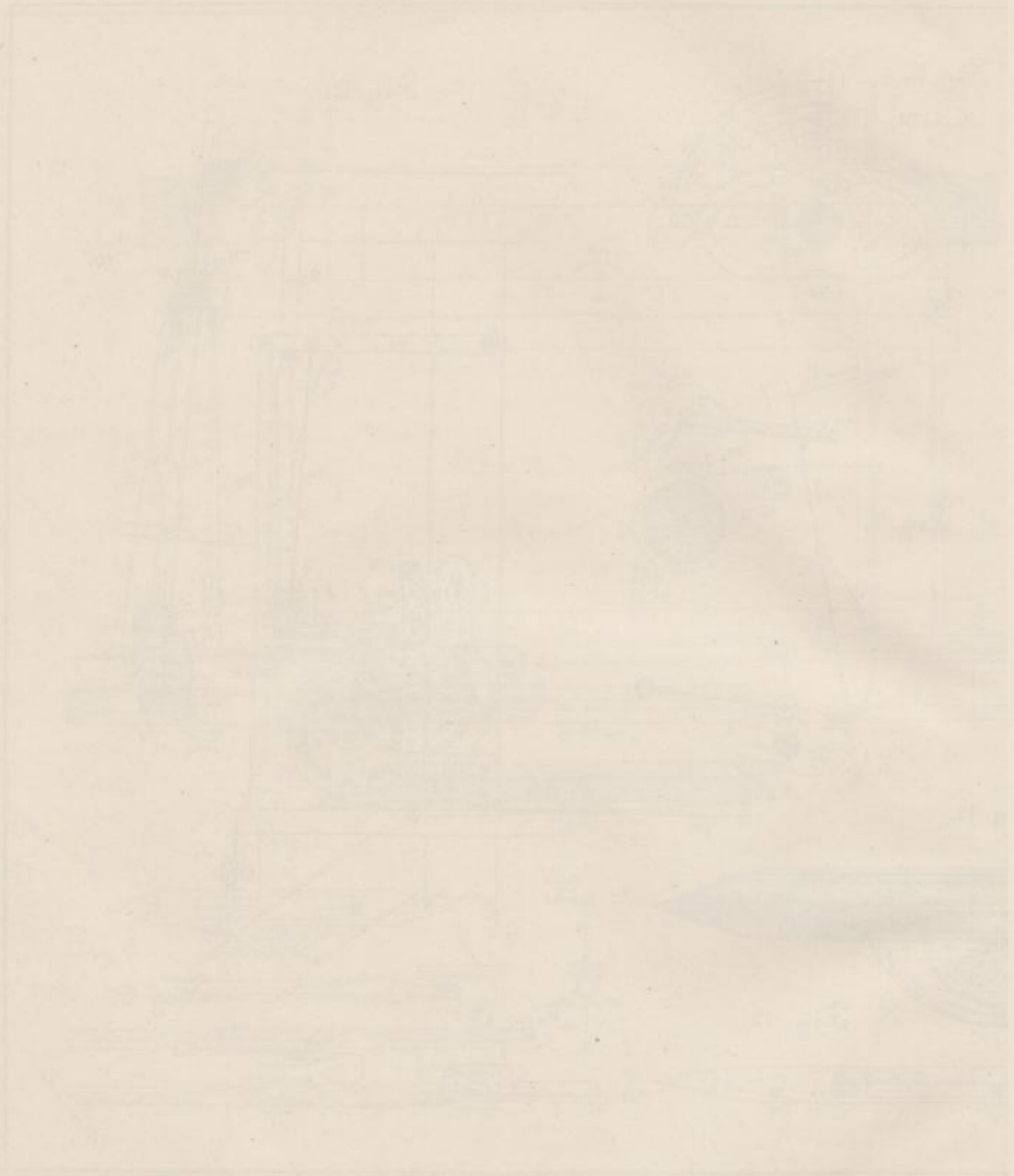

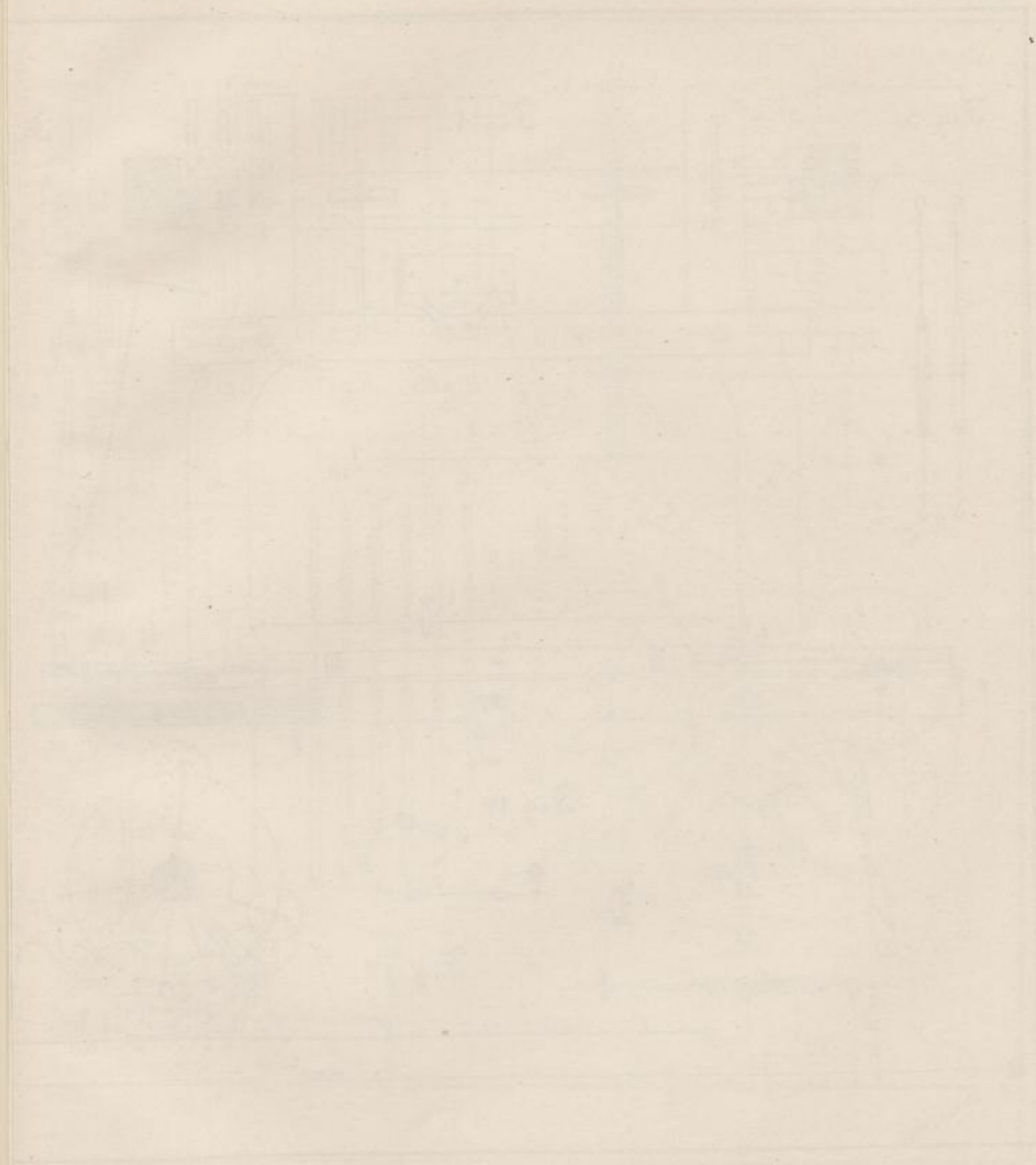

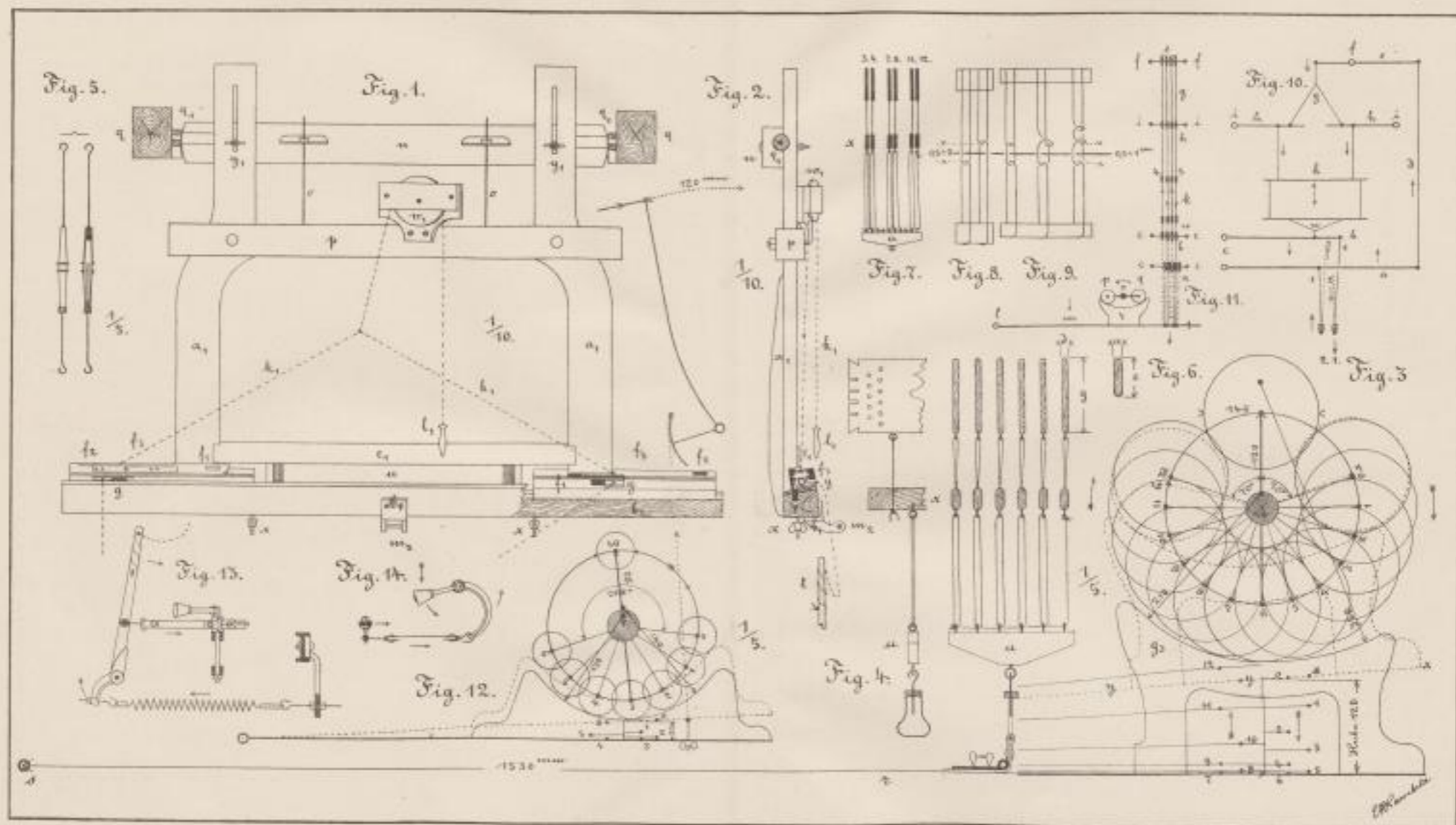

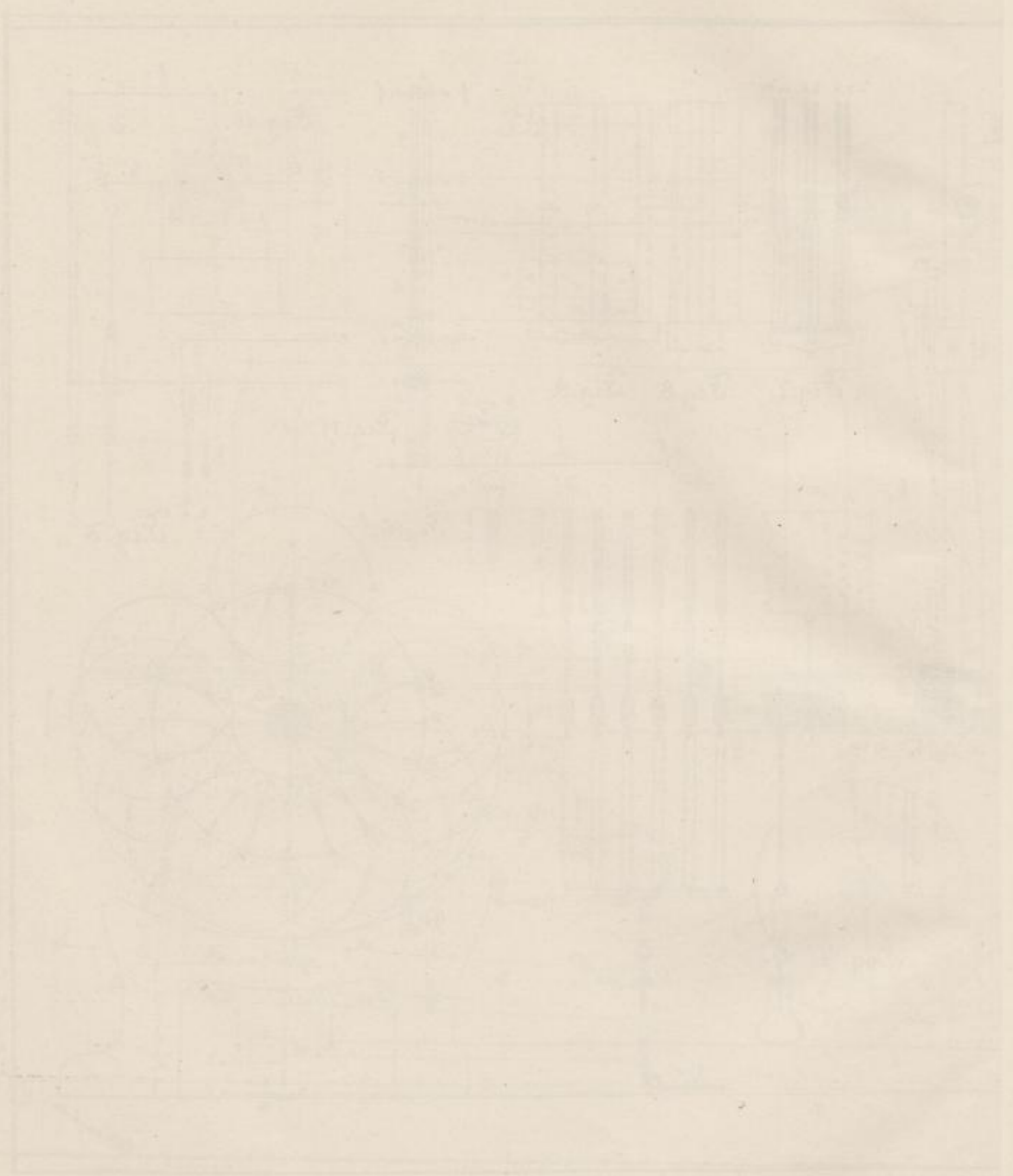

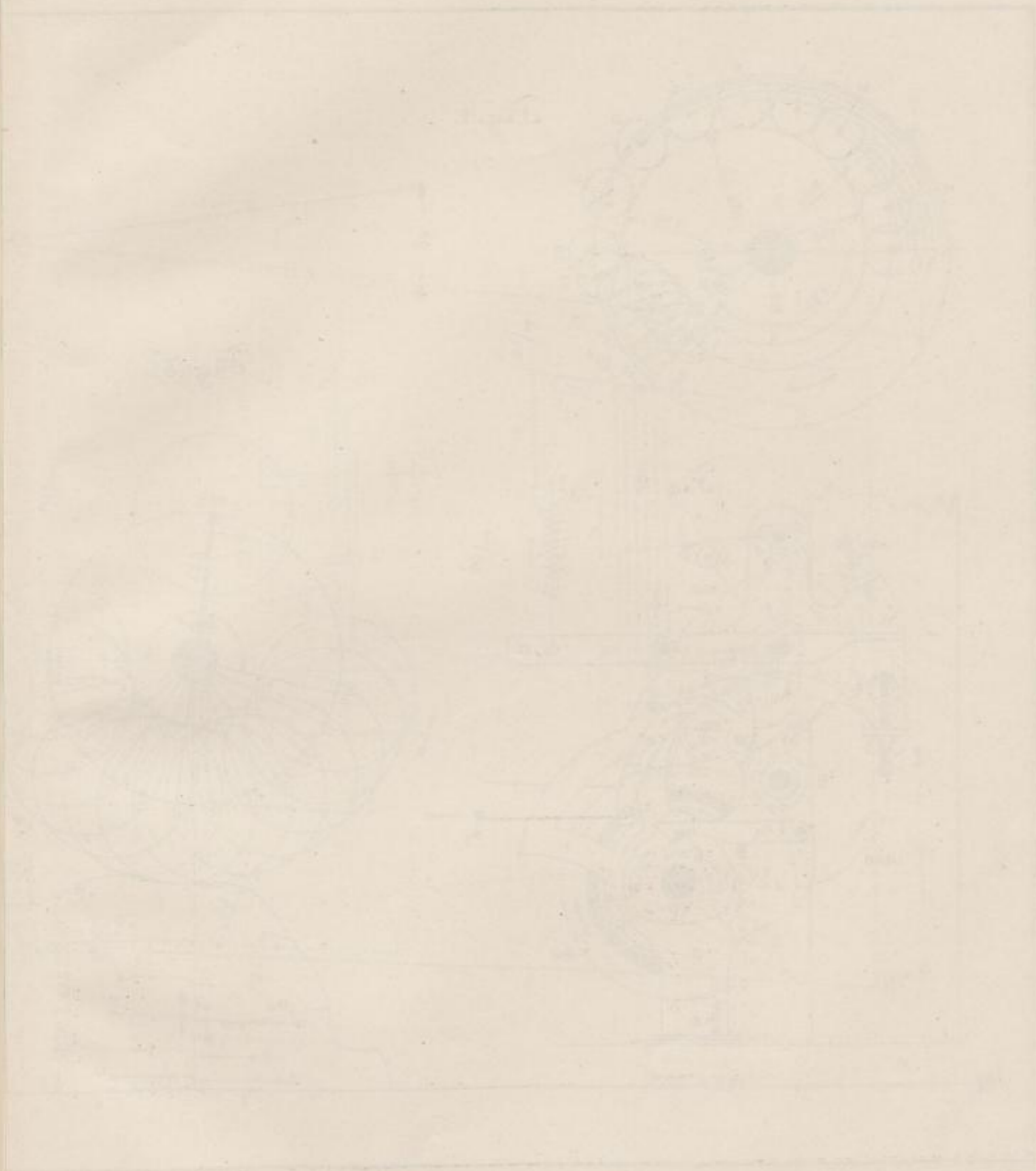

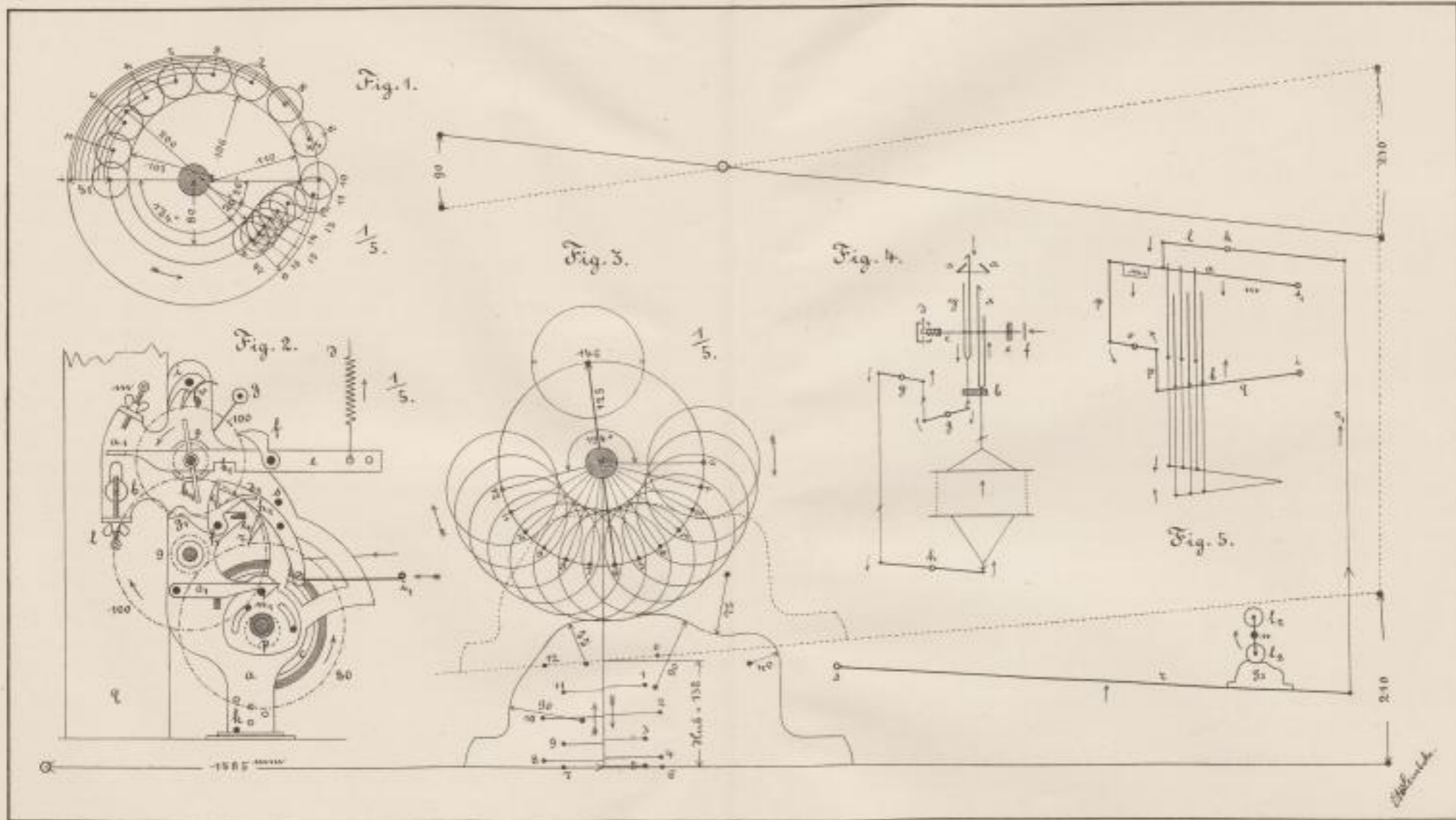

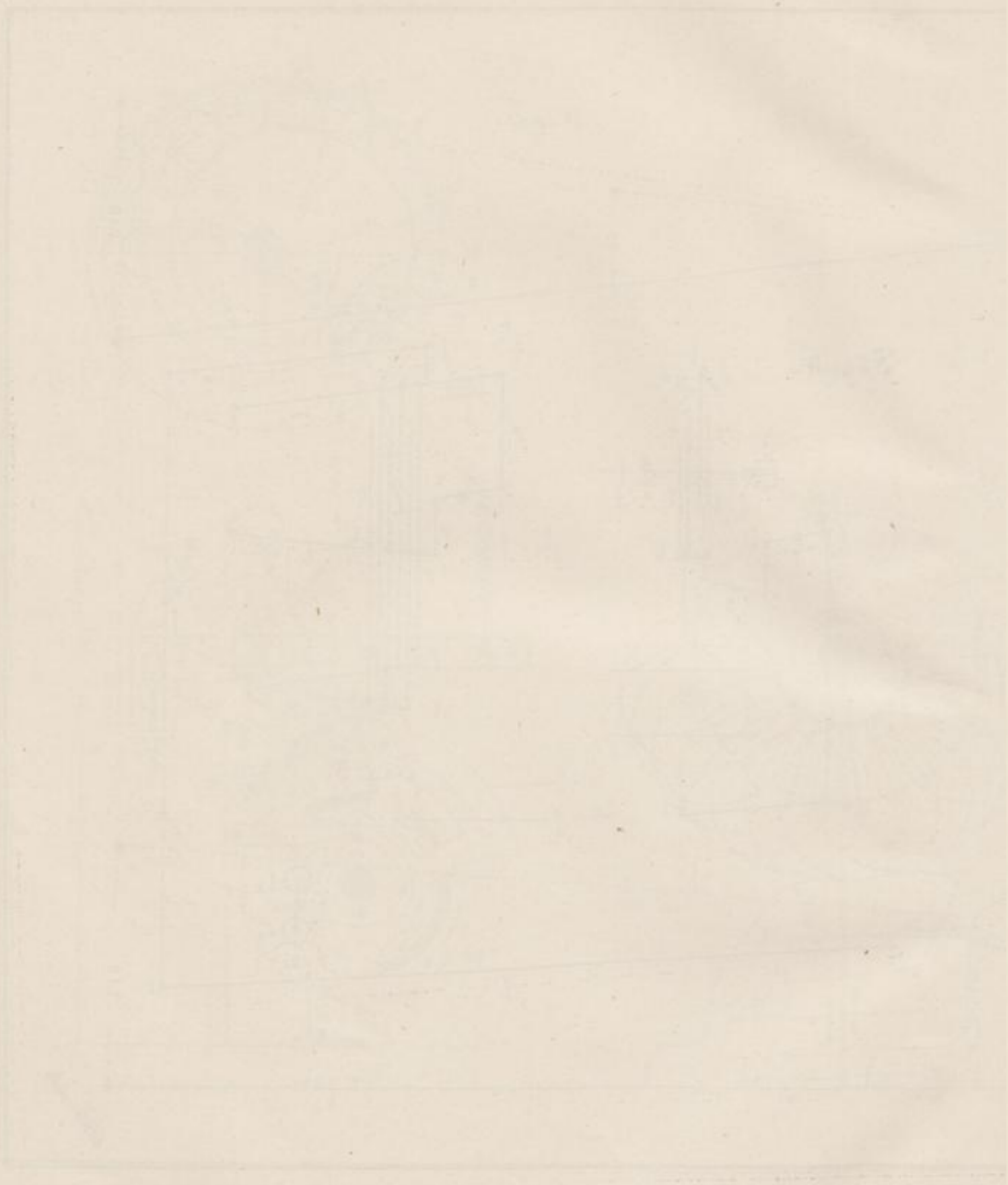

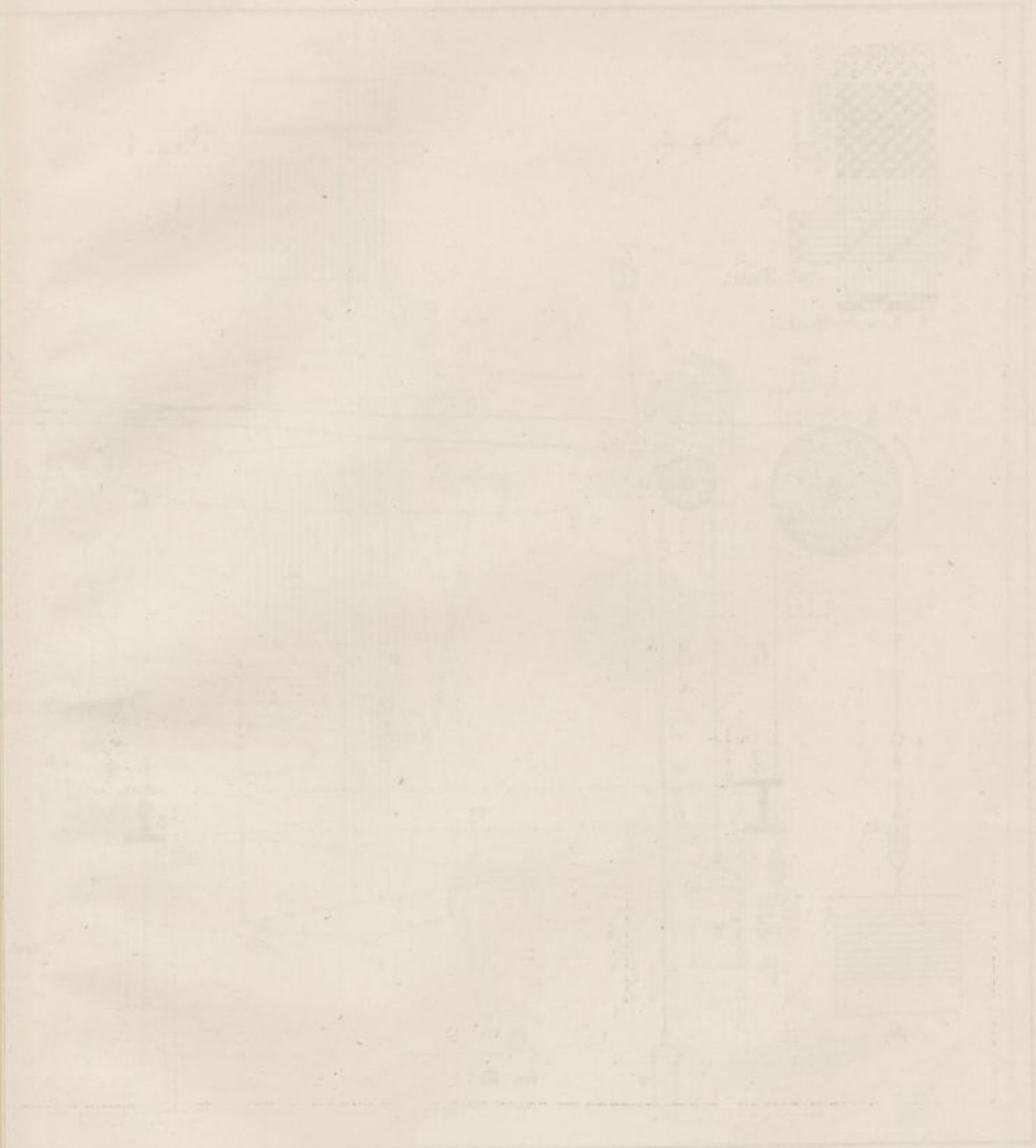

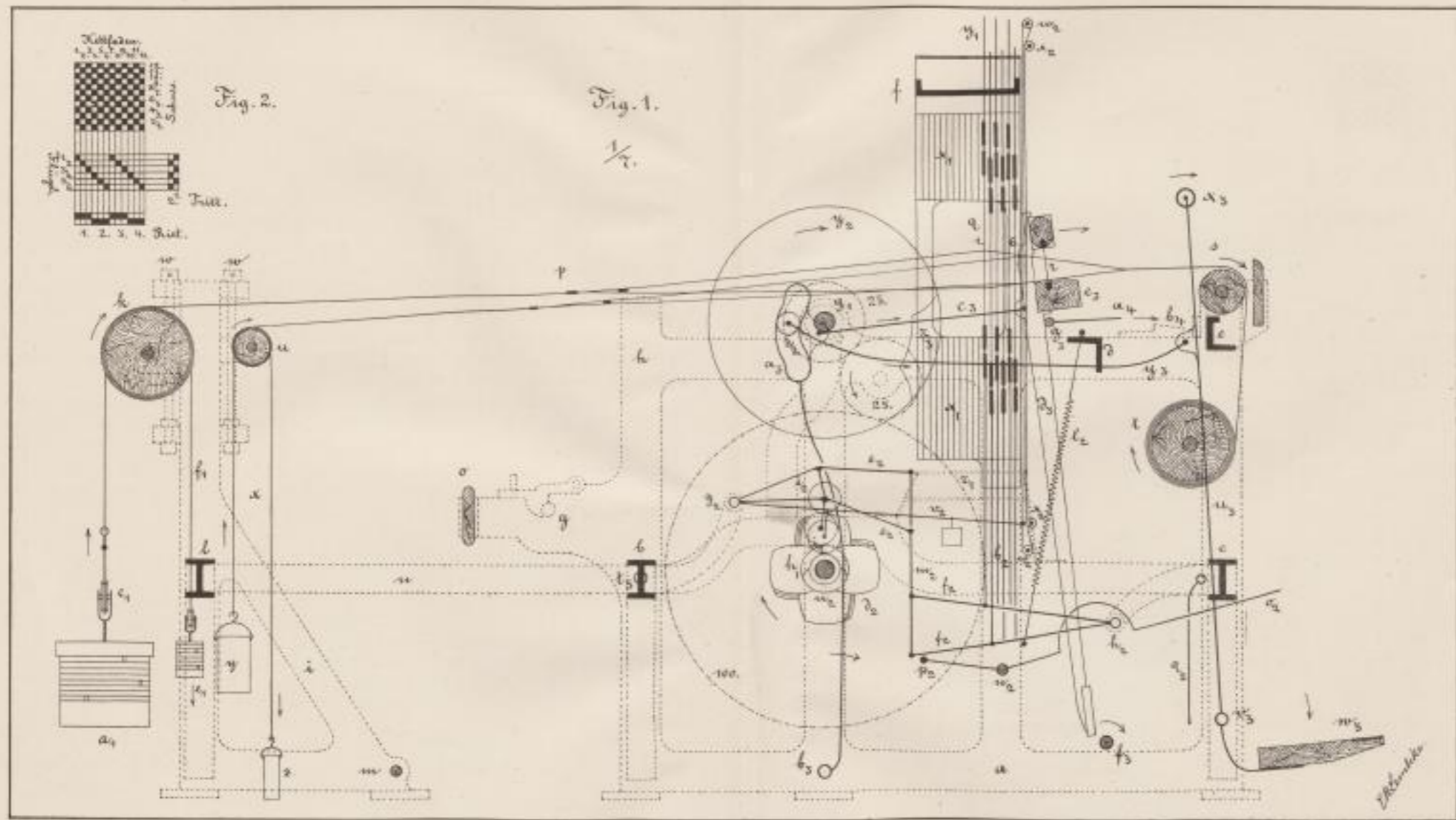

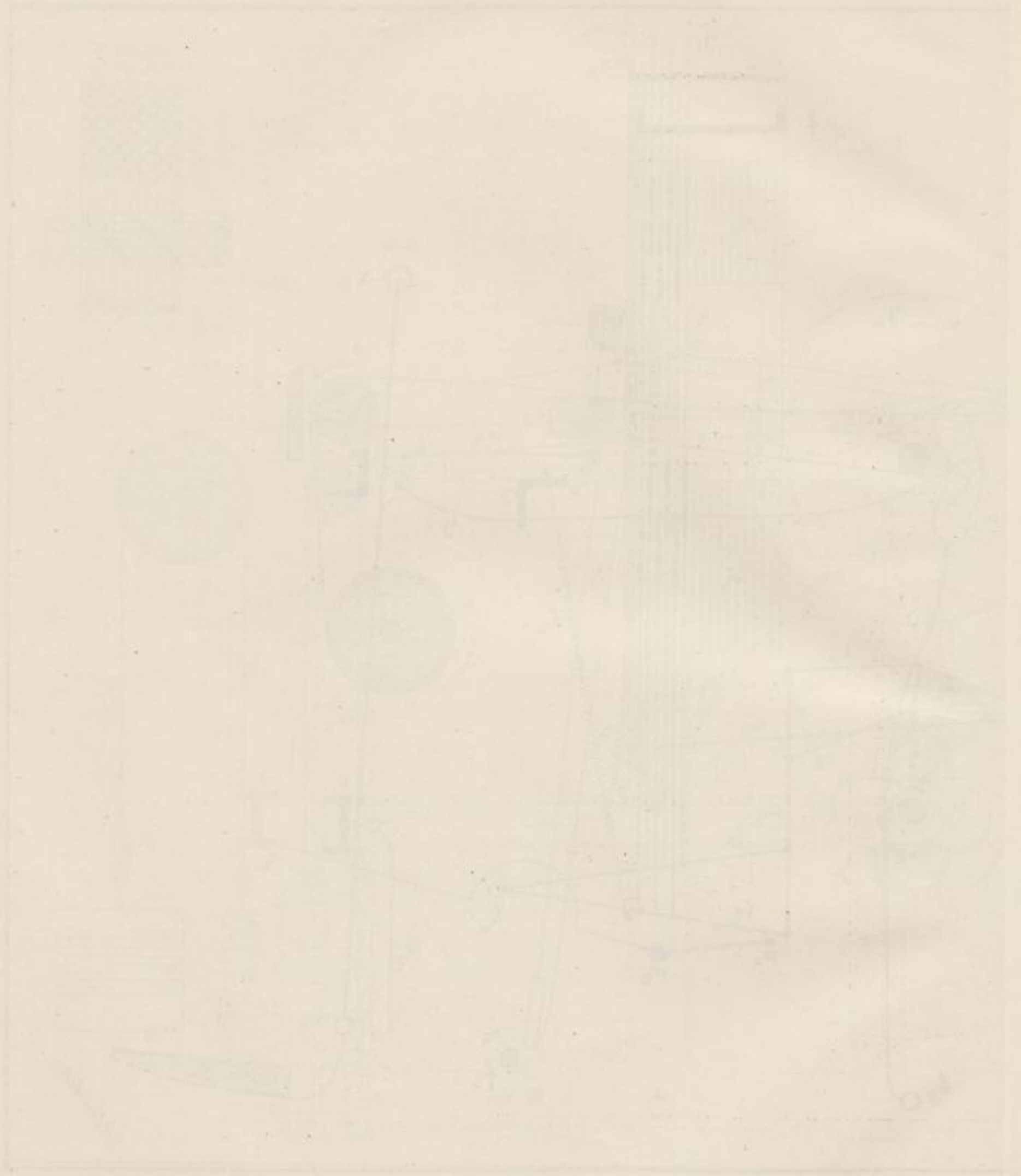

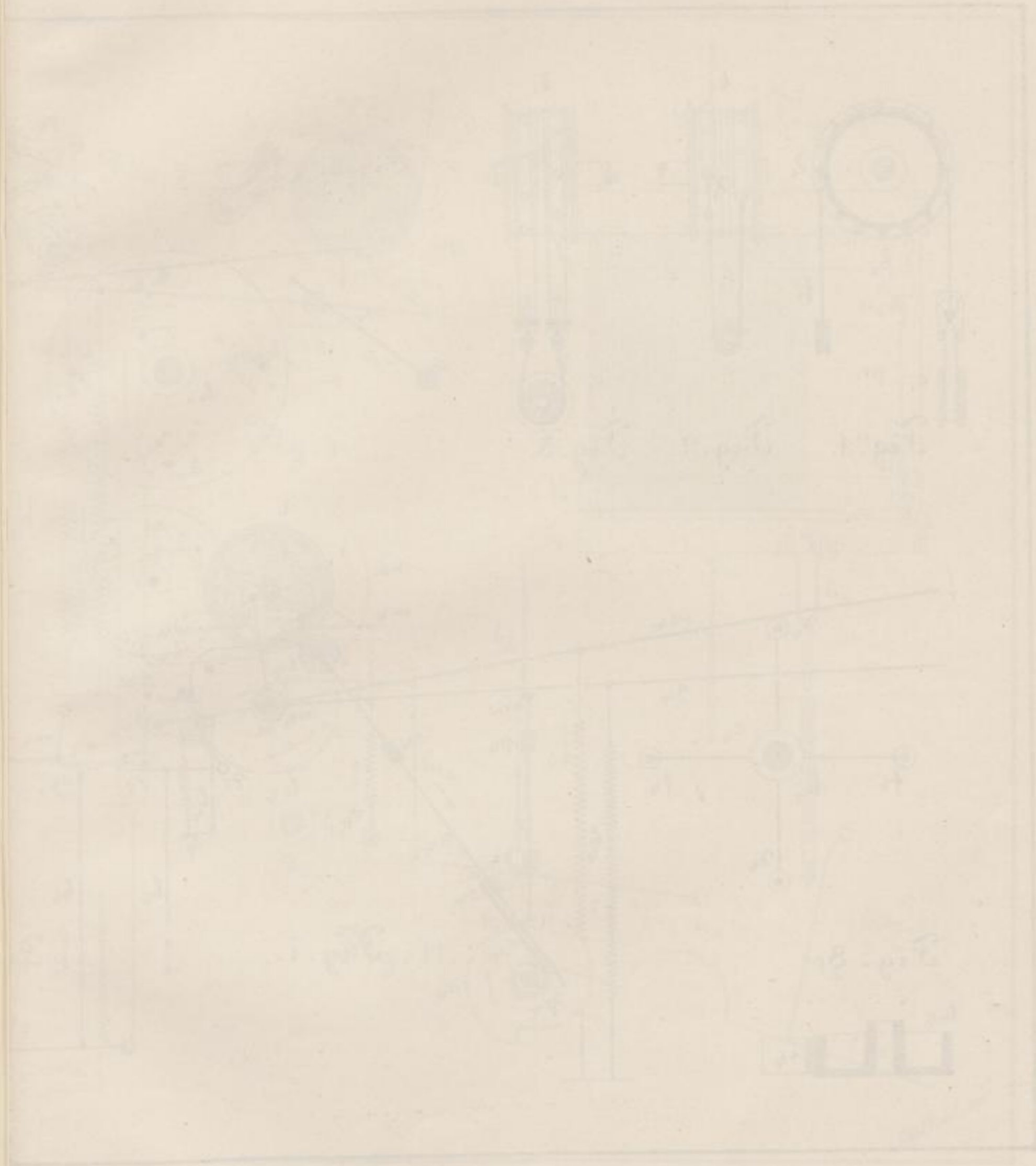

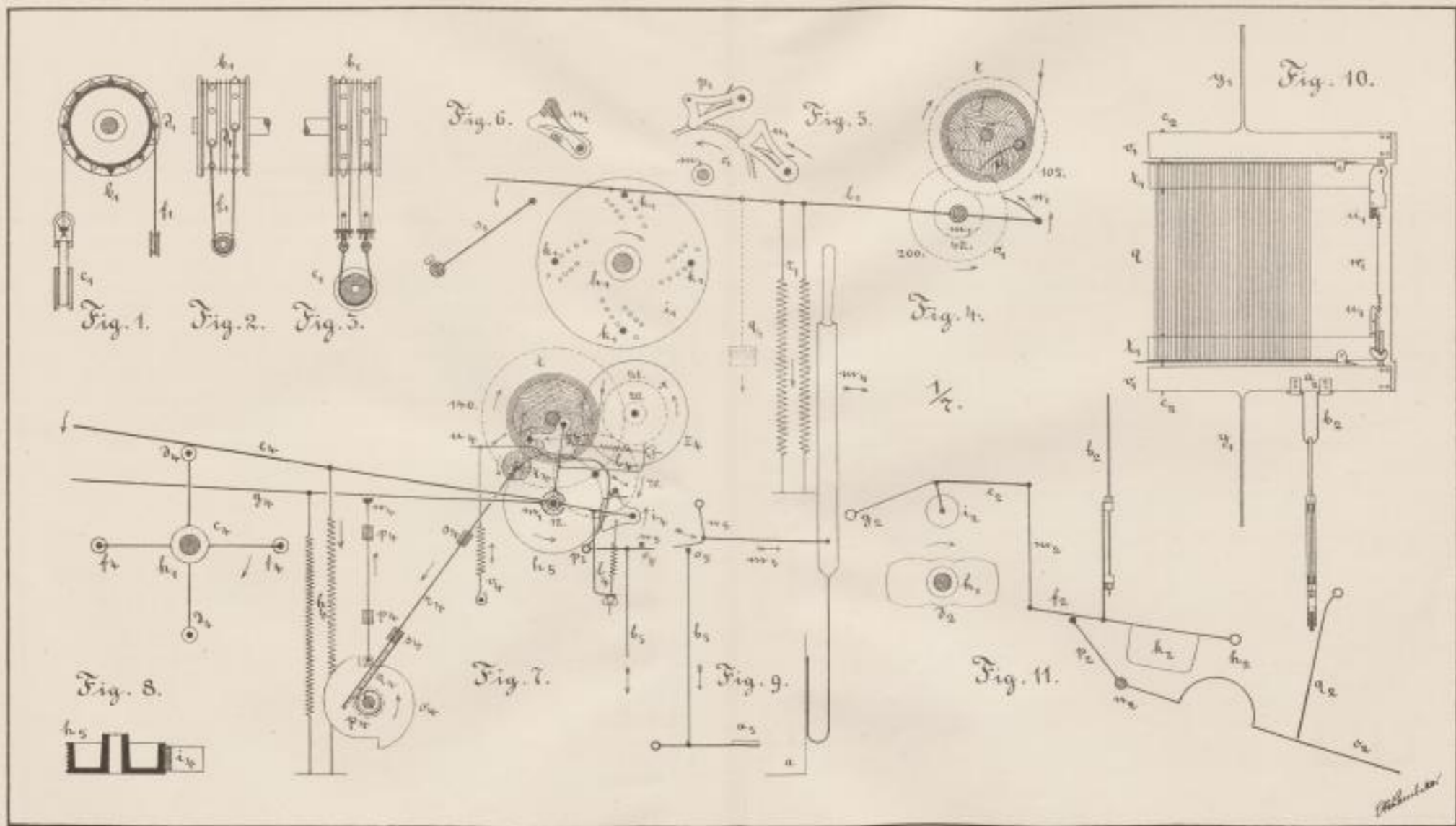

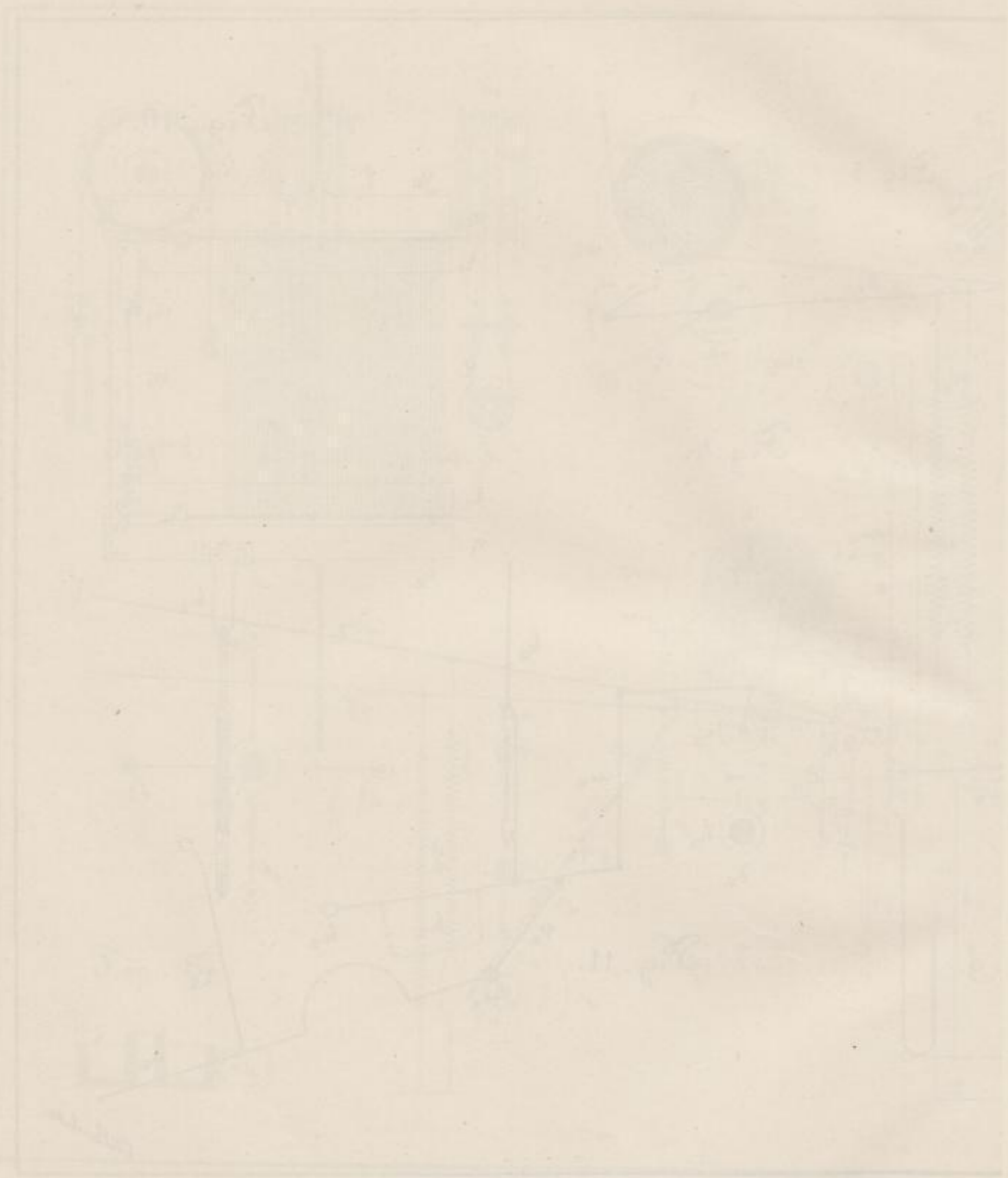

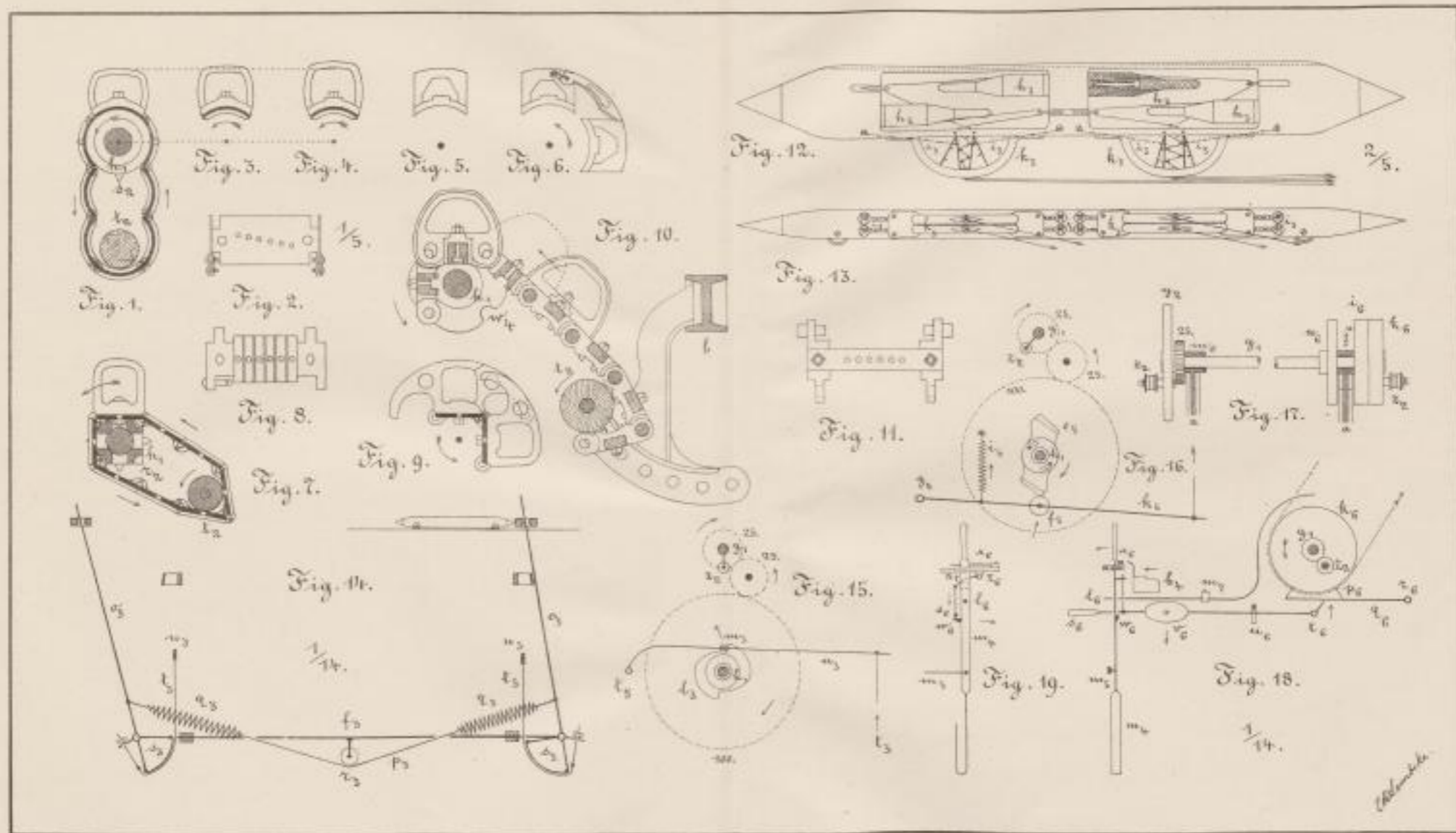

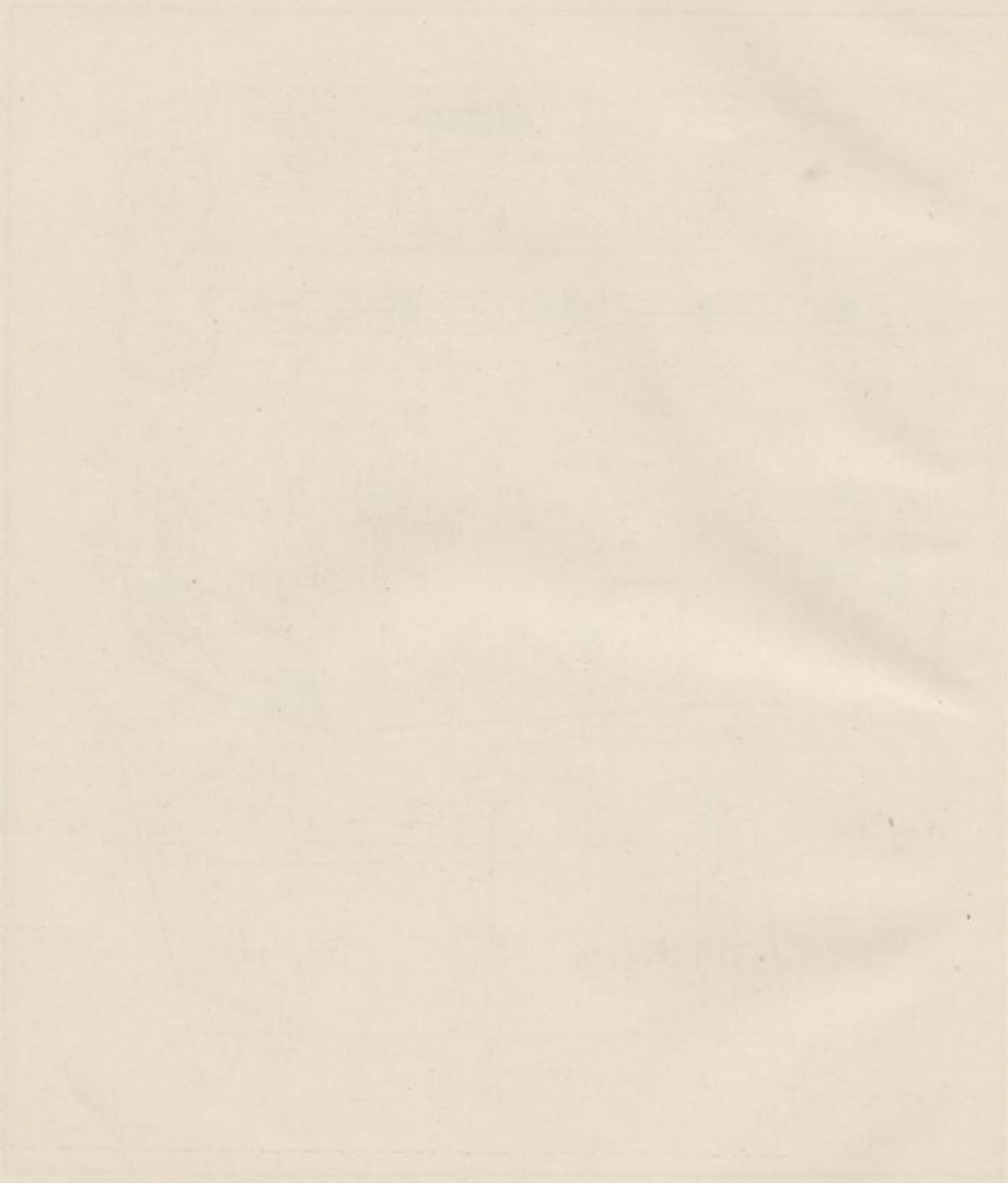

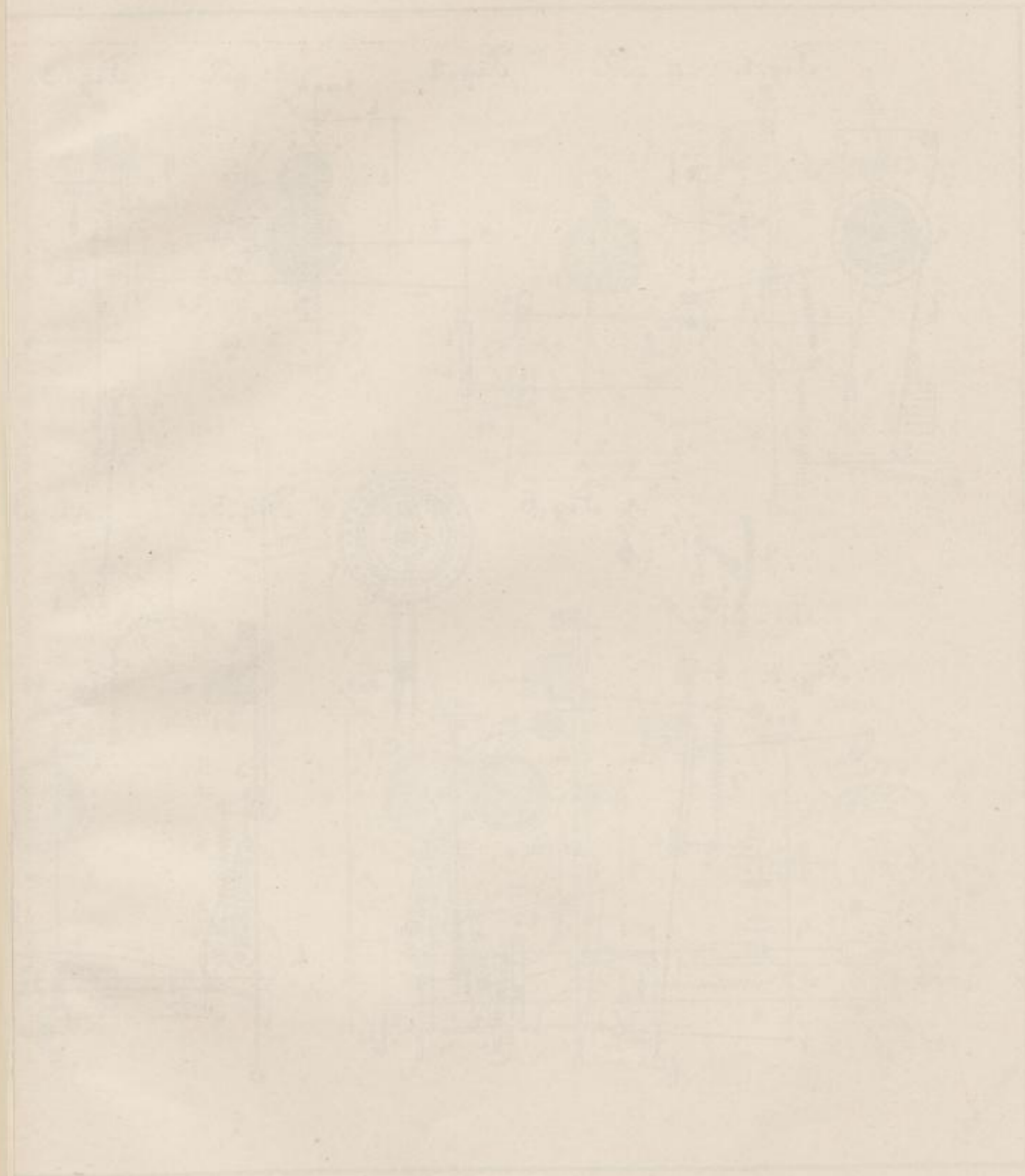

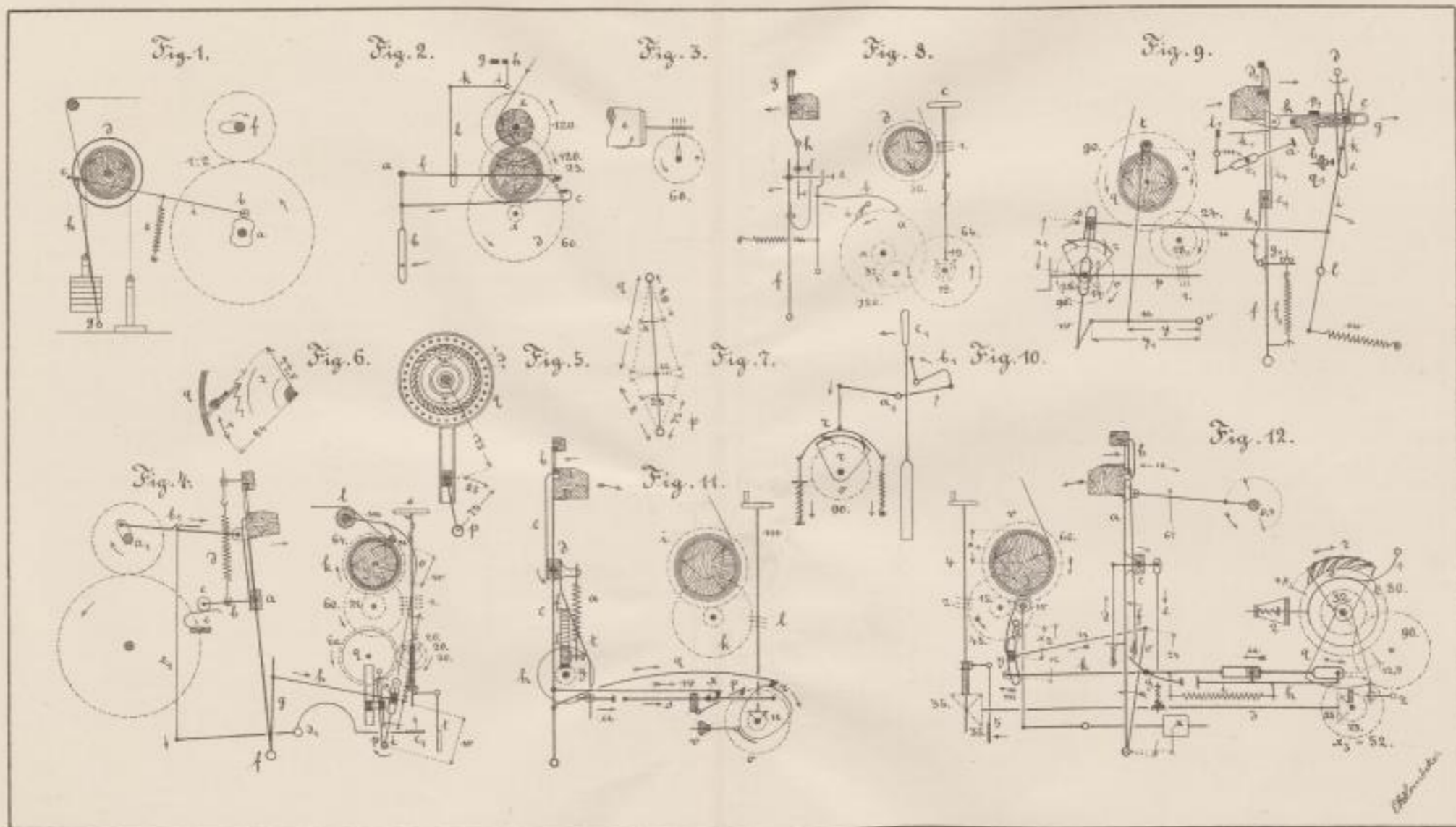

Abbrücken

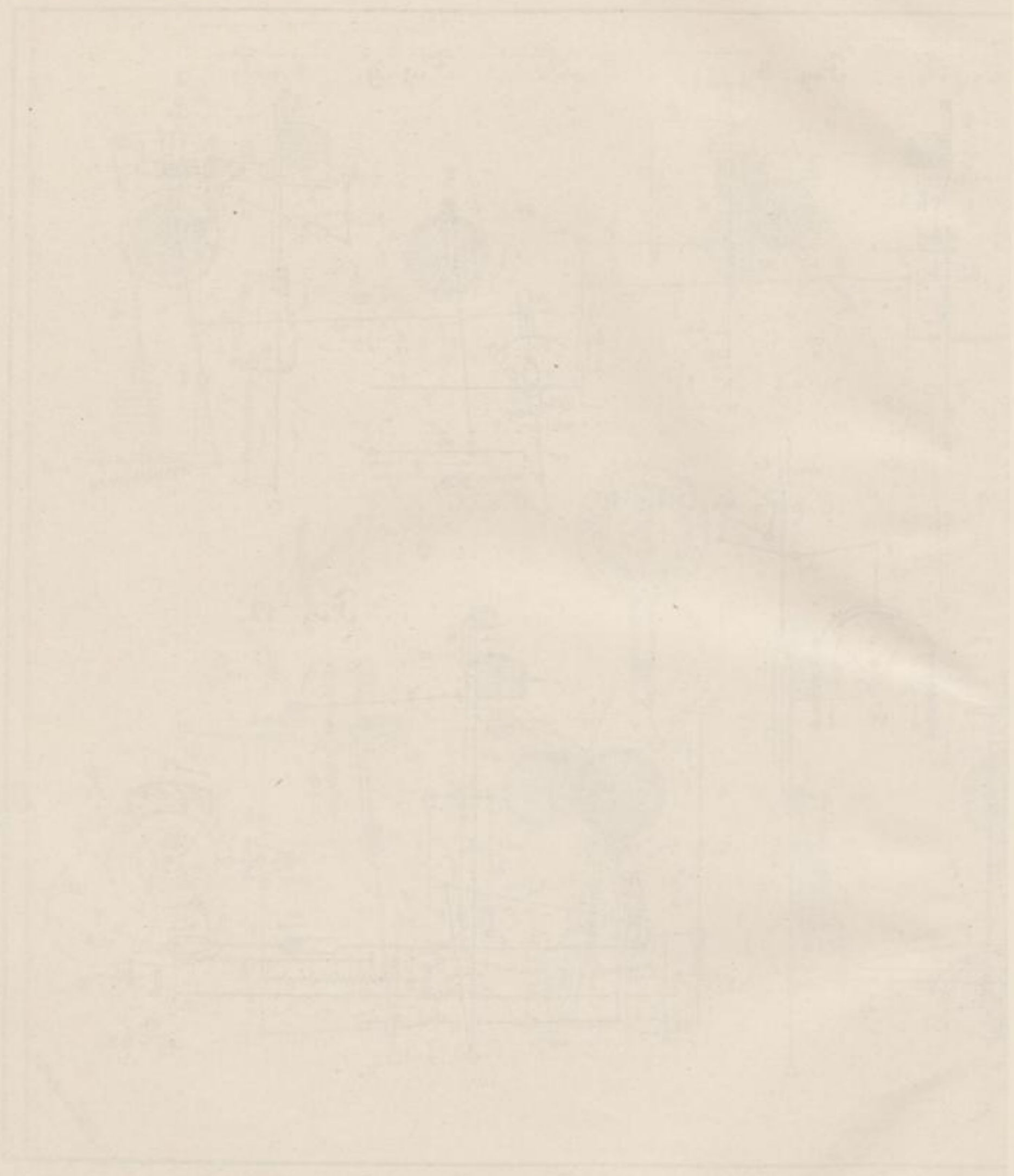

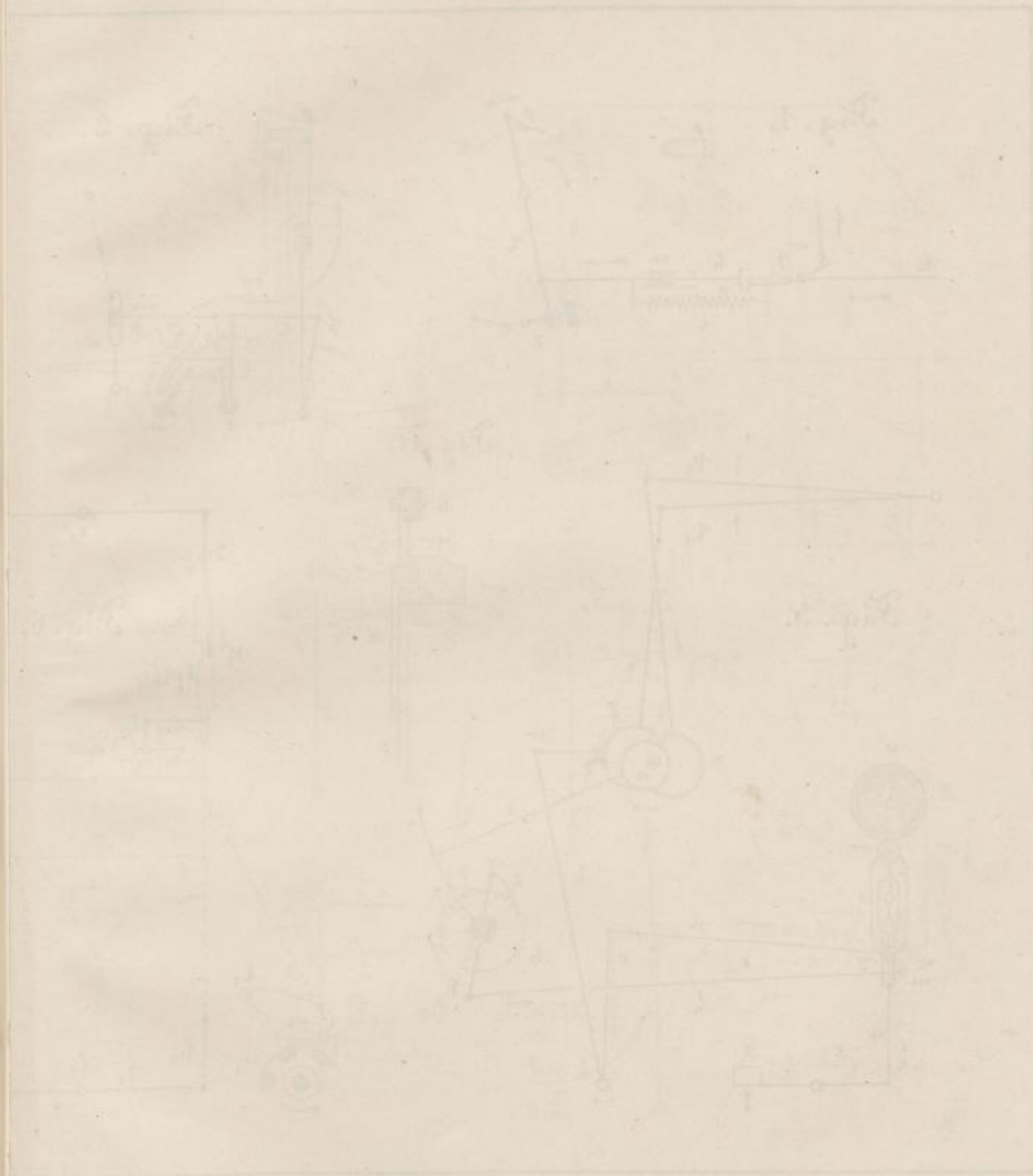

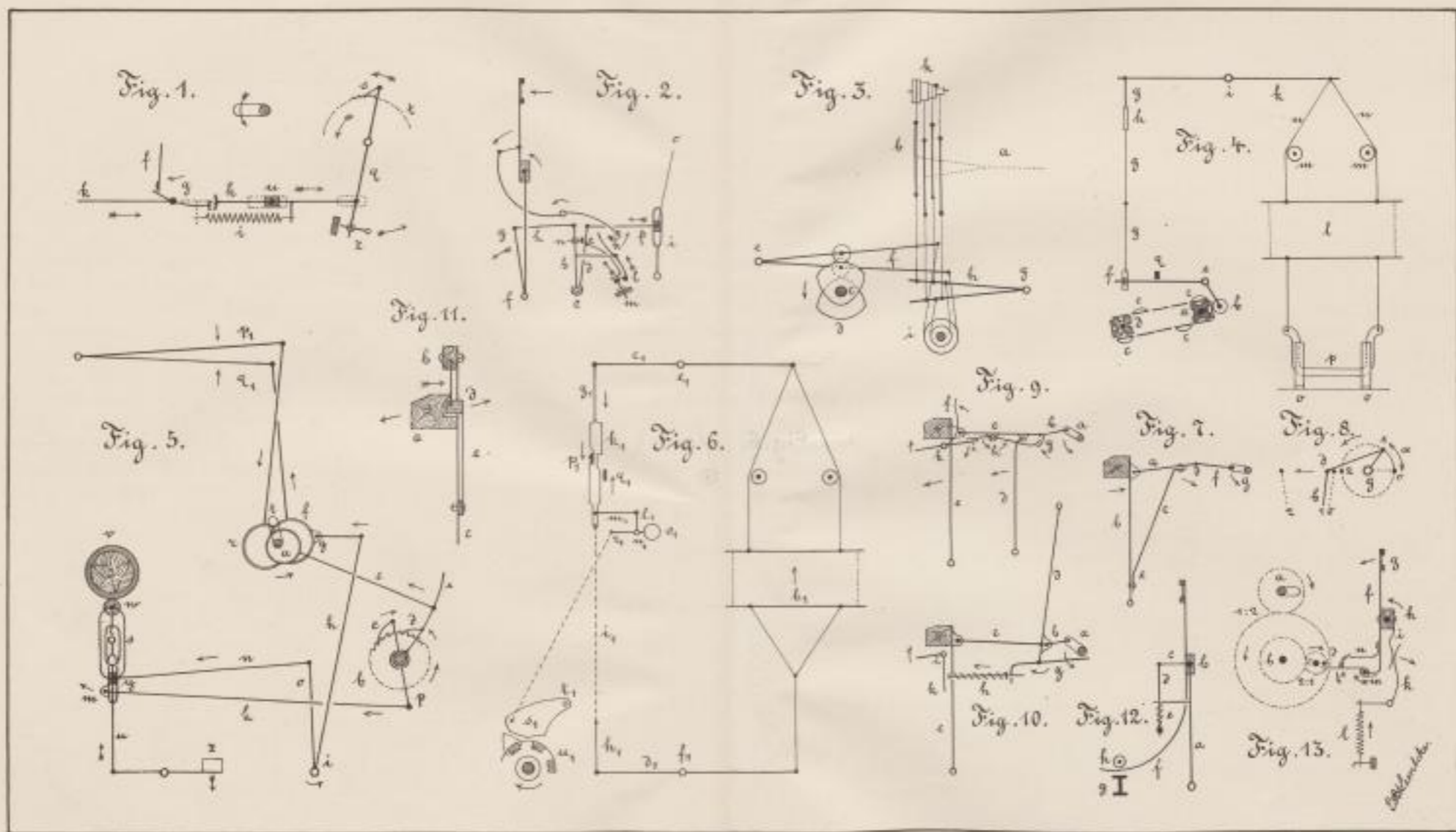

20. 10. 18

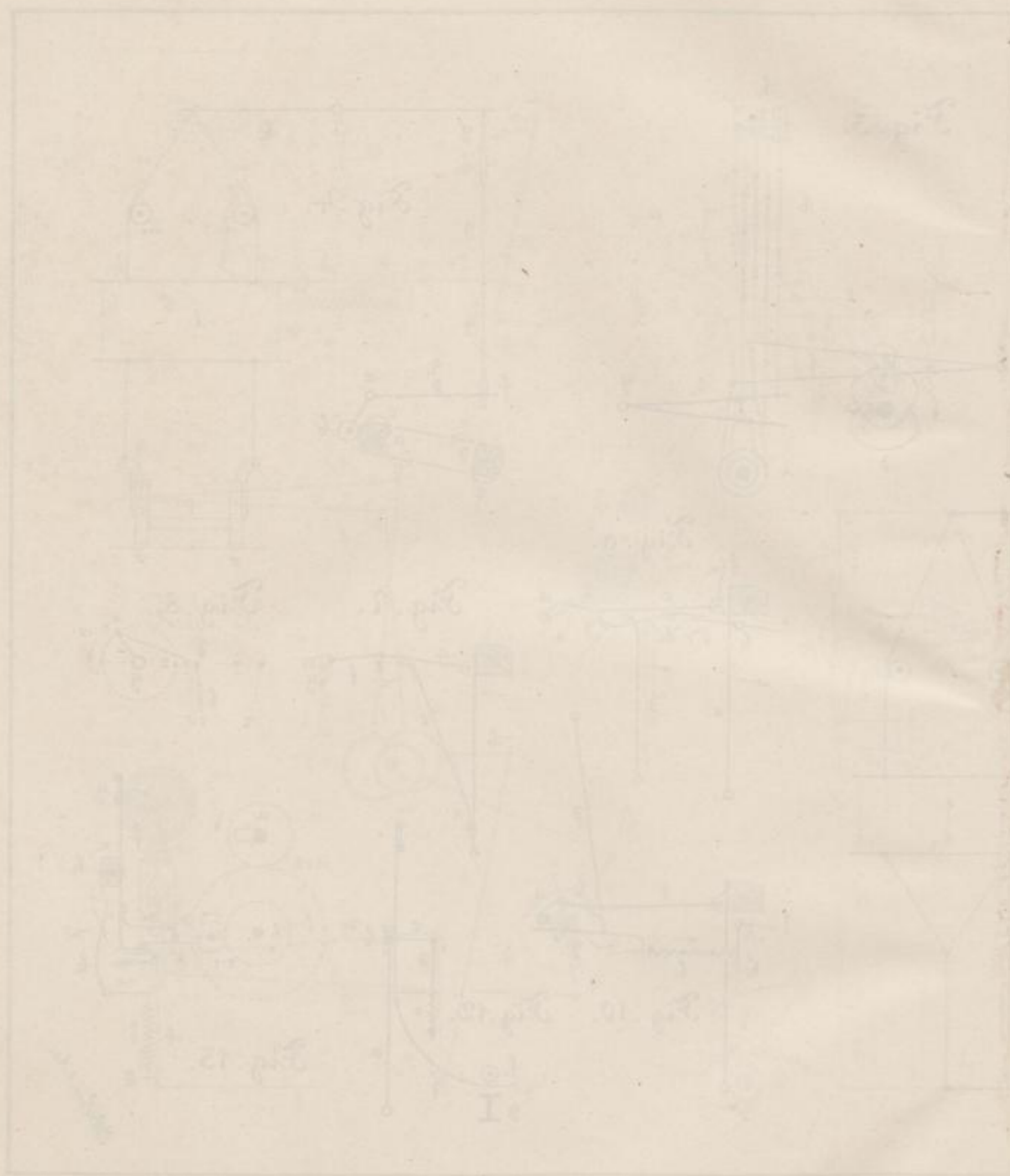



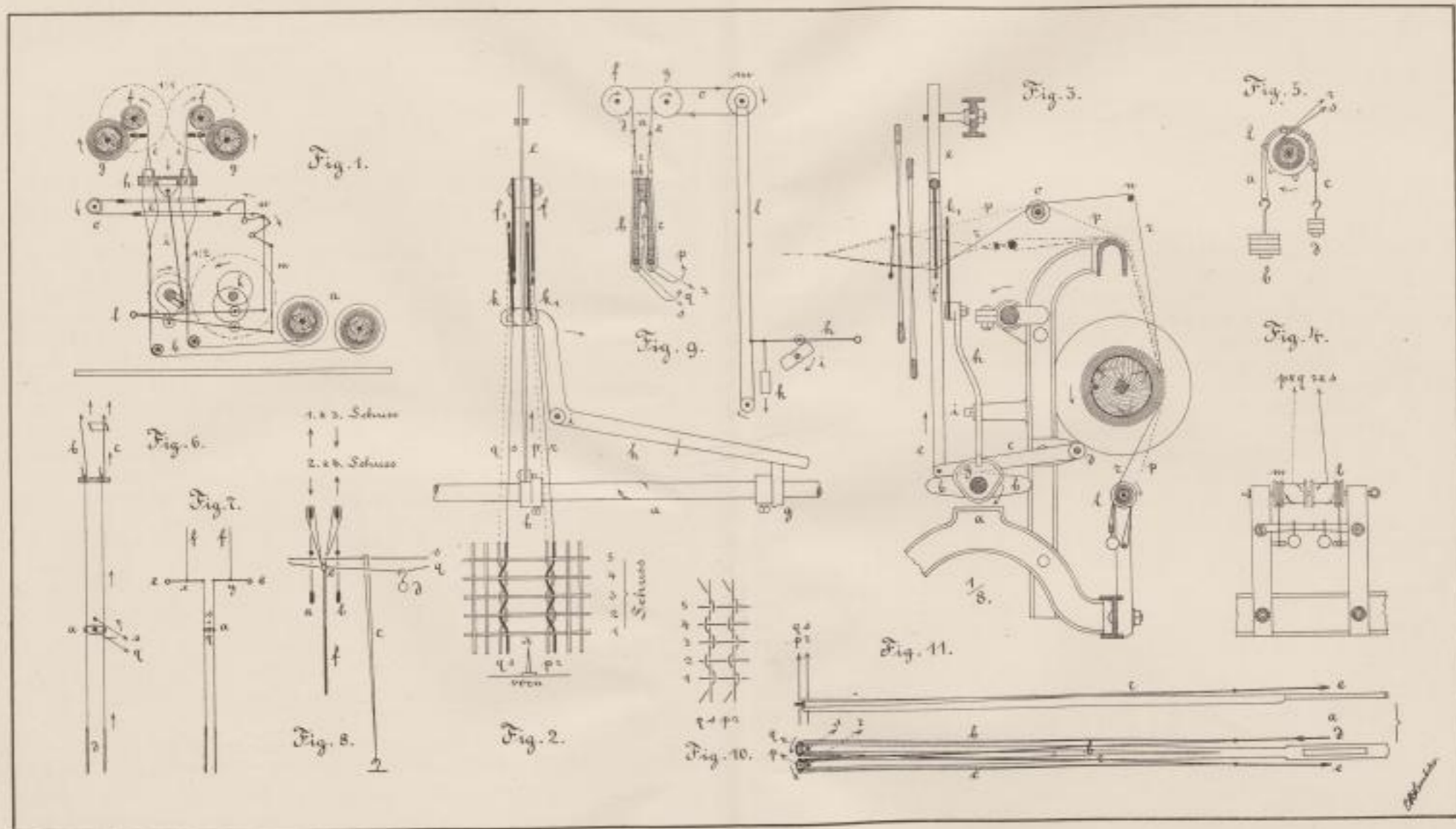

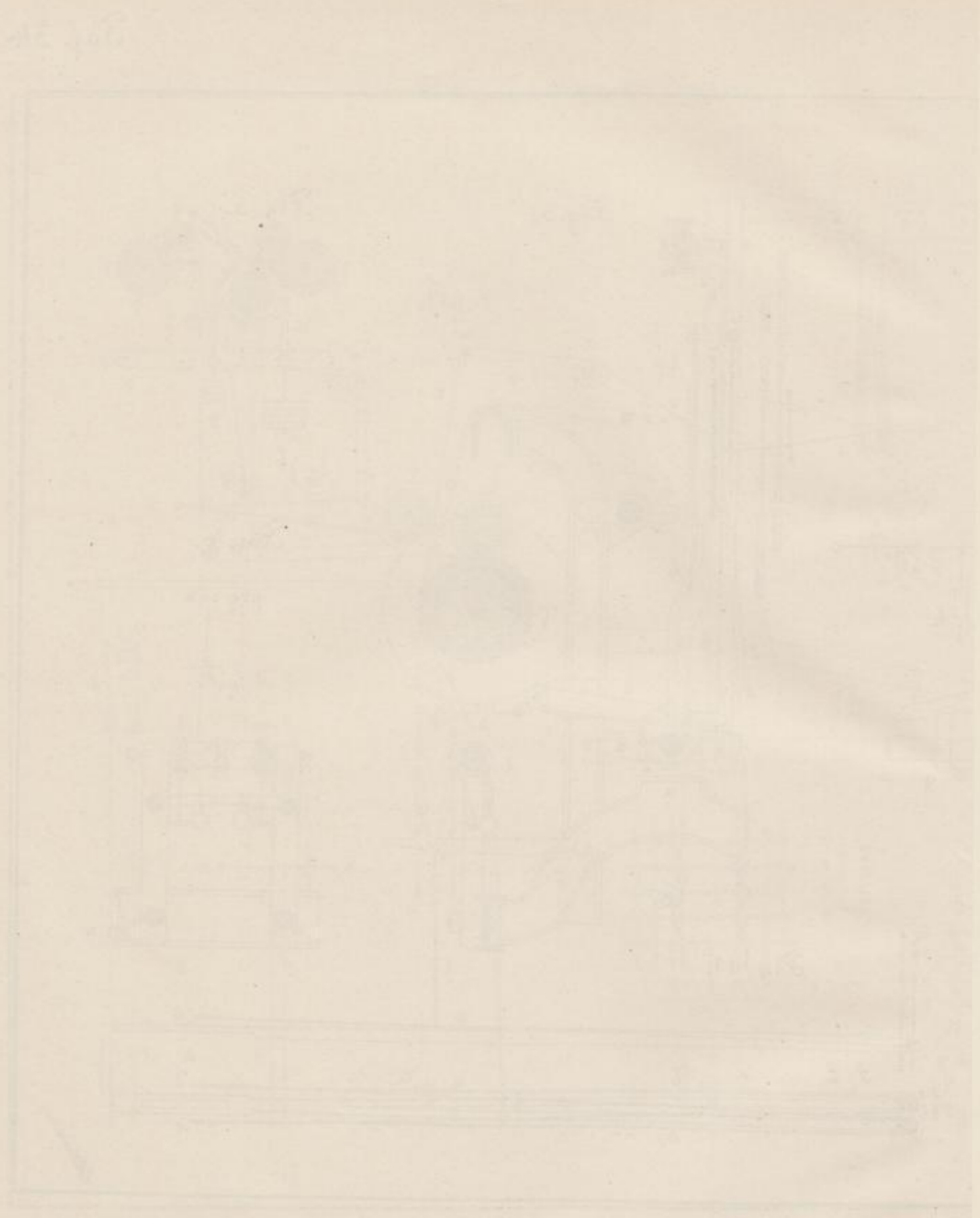

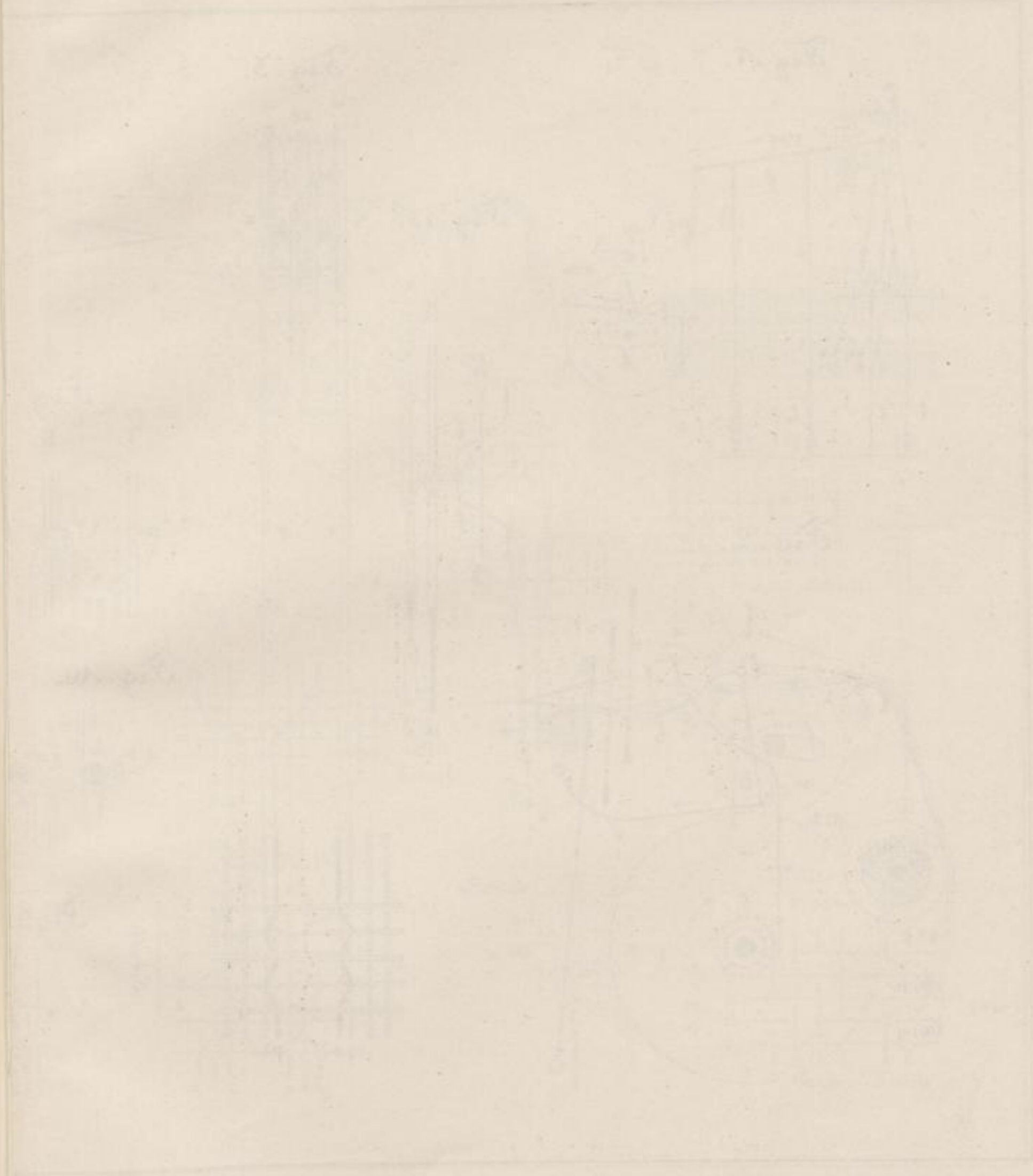

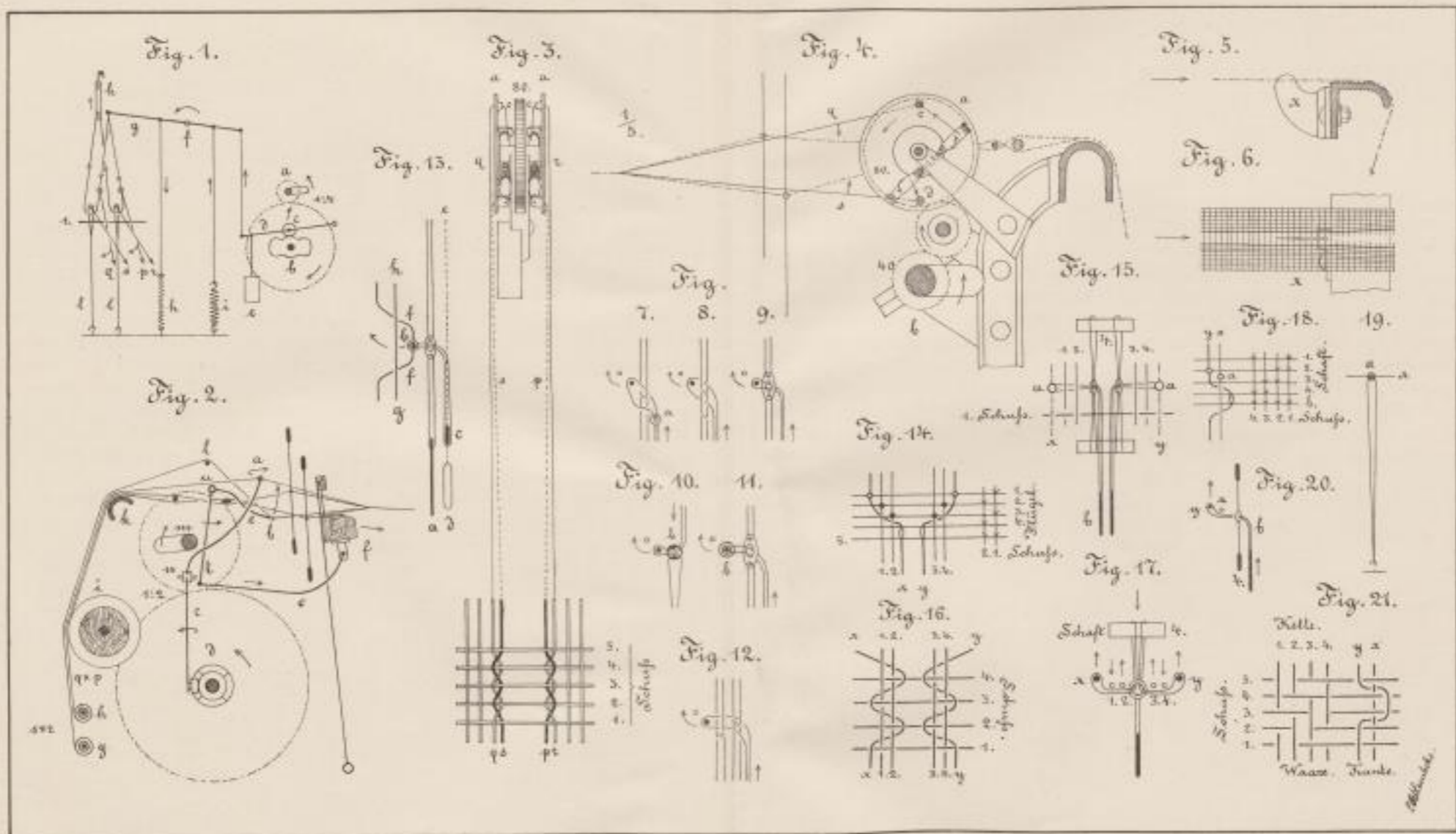

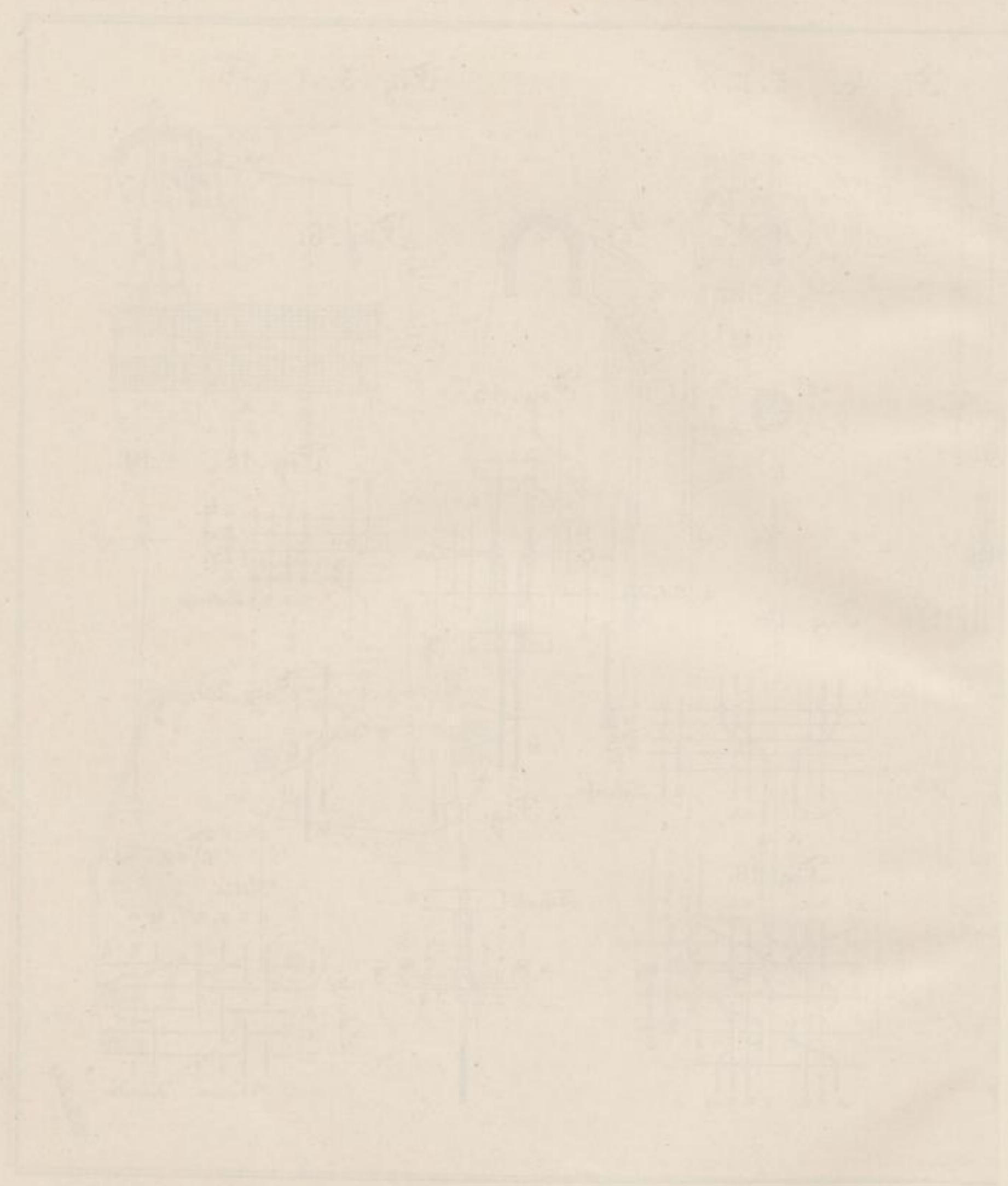

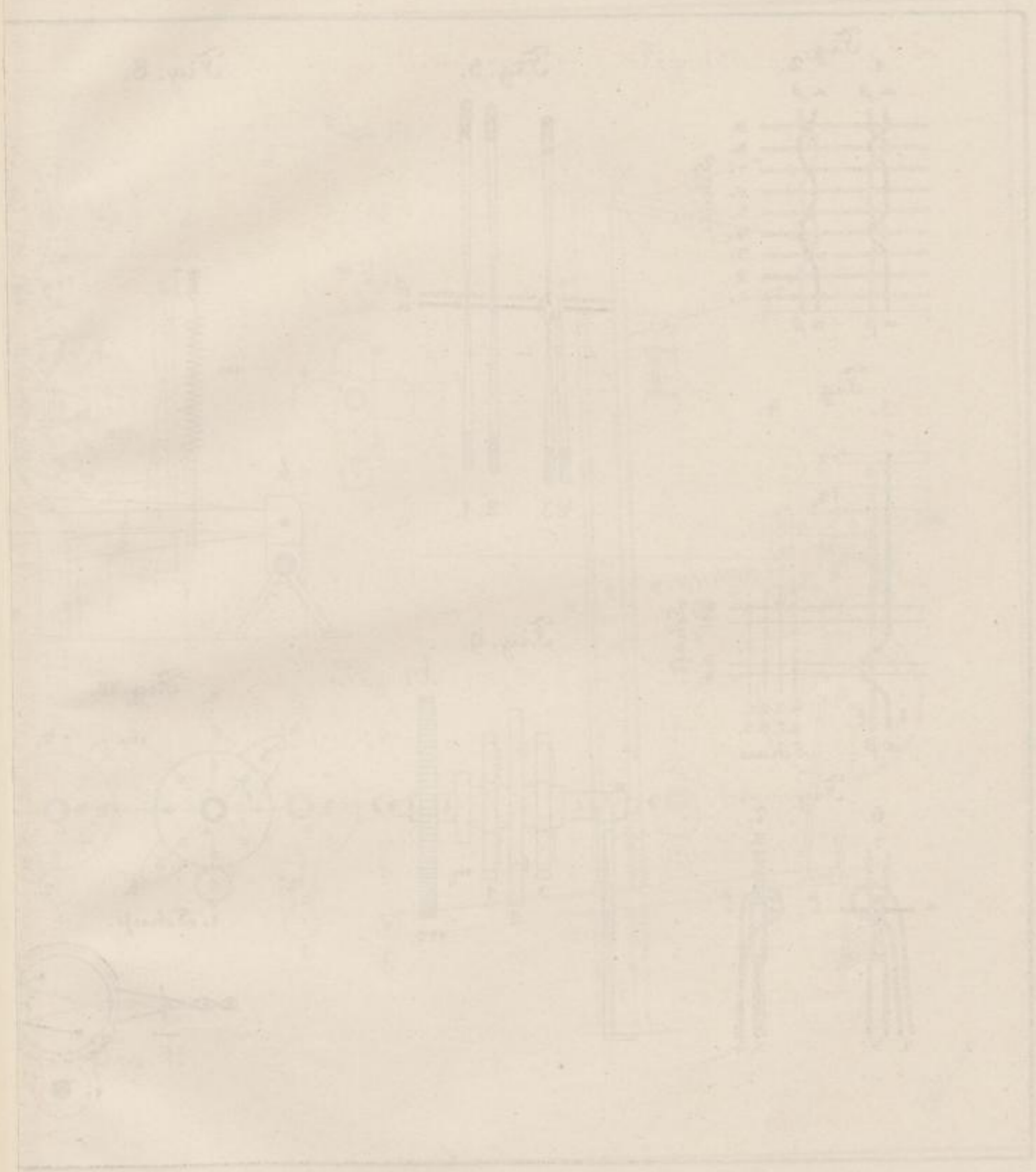

16. Jul

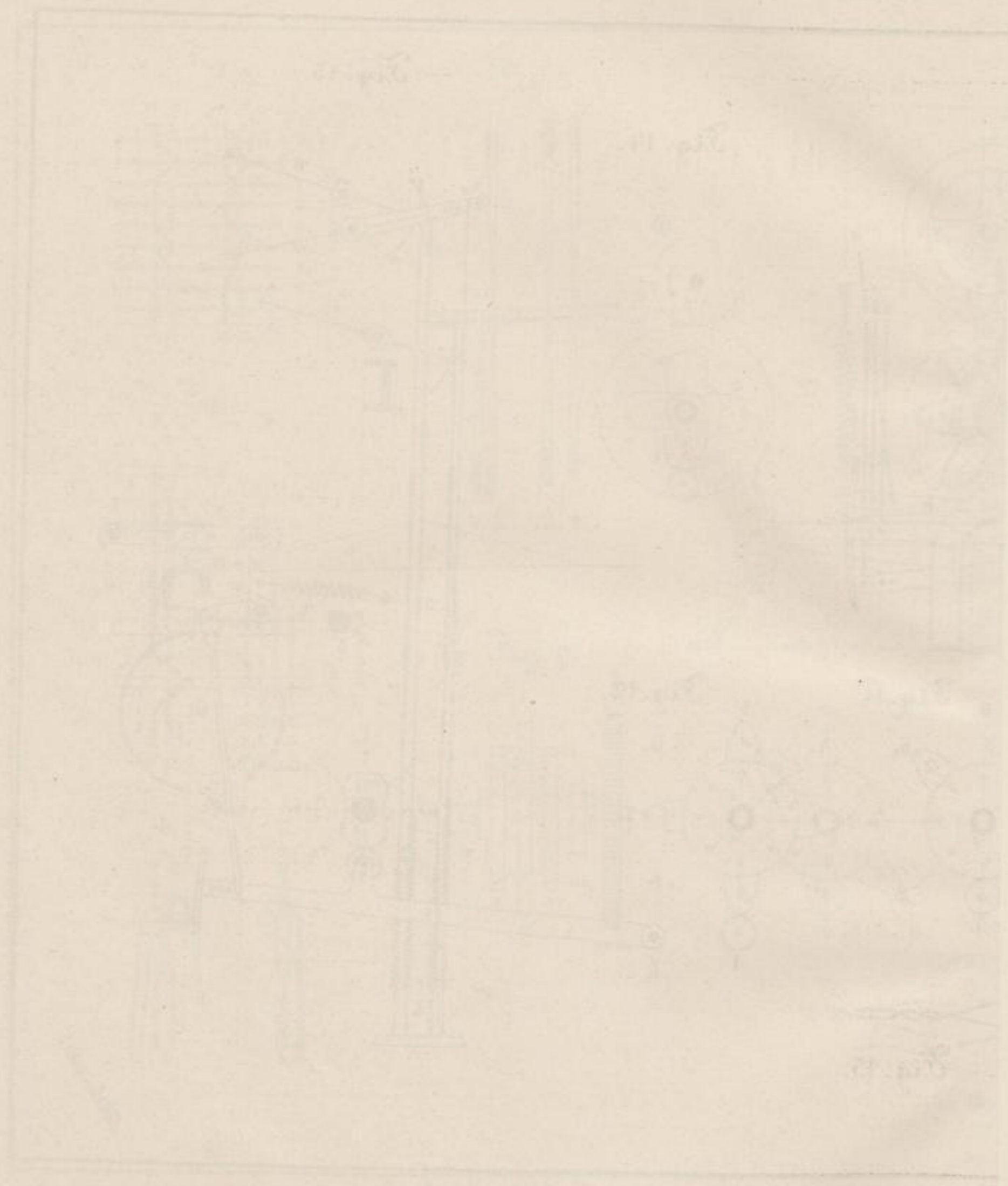



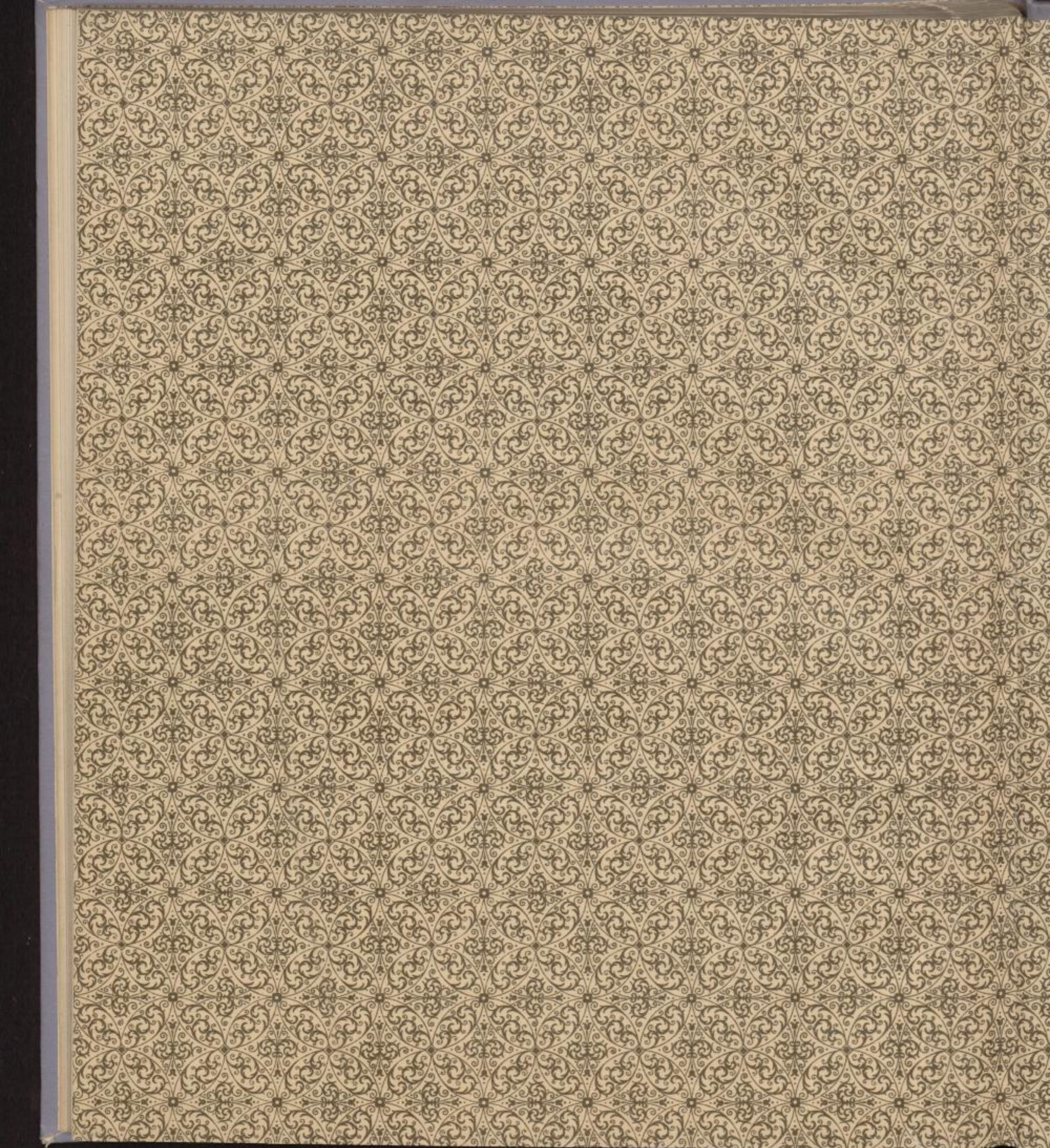

SLUB

Wir führen Wissen.

<http://digital.slub-dresden.de/id456881794/44>



Westsächsische Hochschule Zwickau
Hochschulbibliothek



Hochschulbibliothek Zwickau 00277049

