

1-2



G.  
1001.  
Atlas.















PUBLICATIONS INDUSTRIELLES DE E. LACROIX

---

TRAITÉ THÉORIQUE ET PRATIQUE  
DES  
MÉTIERS A FILER AUTOMATES

DITS  
**SELF-ACTING**

PAR  
ERNEST STAMM  
INGÉNIEUR CIVIL



---

**ATLAS**  
PRIX : 32 FRANCS

---

PARIS  
LIBRAIRIE SCIENTIFIQUE, INDUSTRIELLE ET AGRICOLE DE E. LACROIX, ÉDITEUR  
QUAI MALAQUAIS, 45

1862



Technische Universität  
Chemnitz  
Universitätsbibliothek

WA

G 1001-2







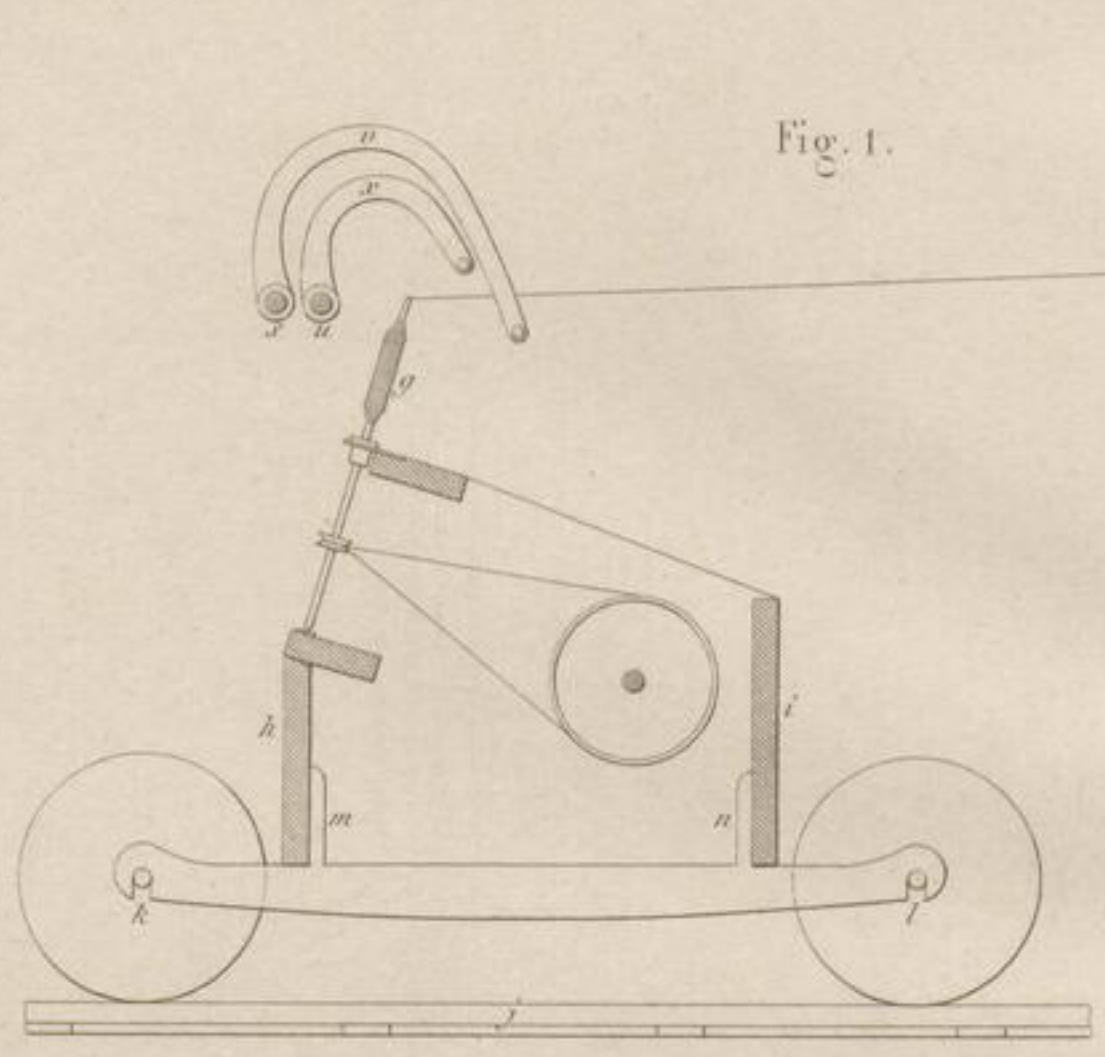

Fig. 1.

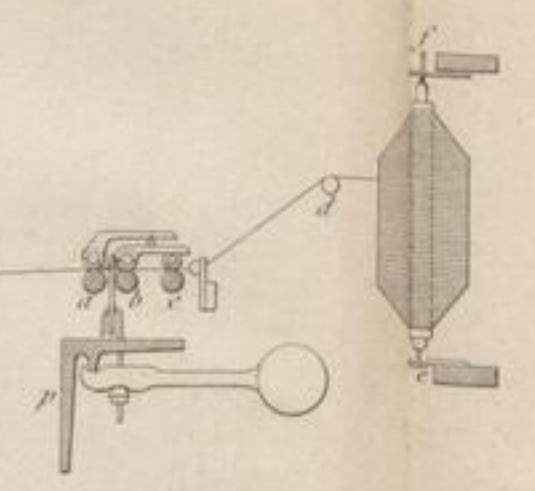

Fig. 2.

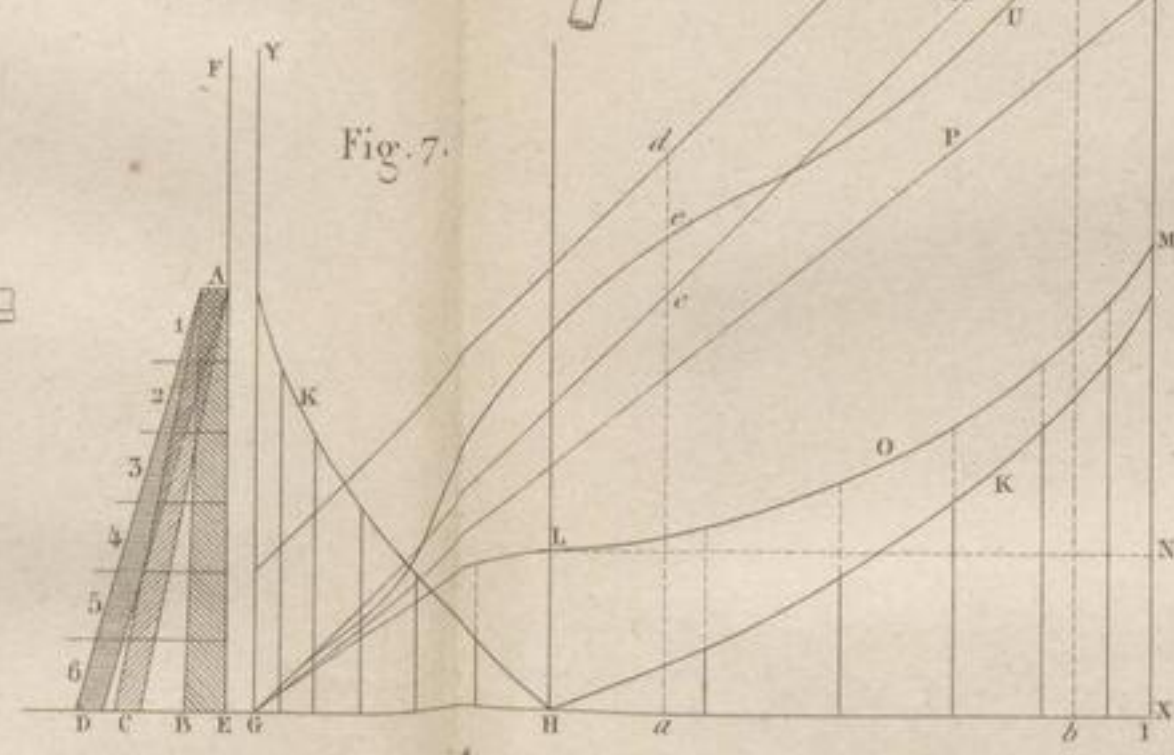

Fig. 7.

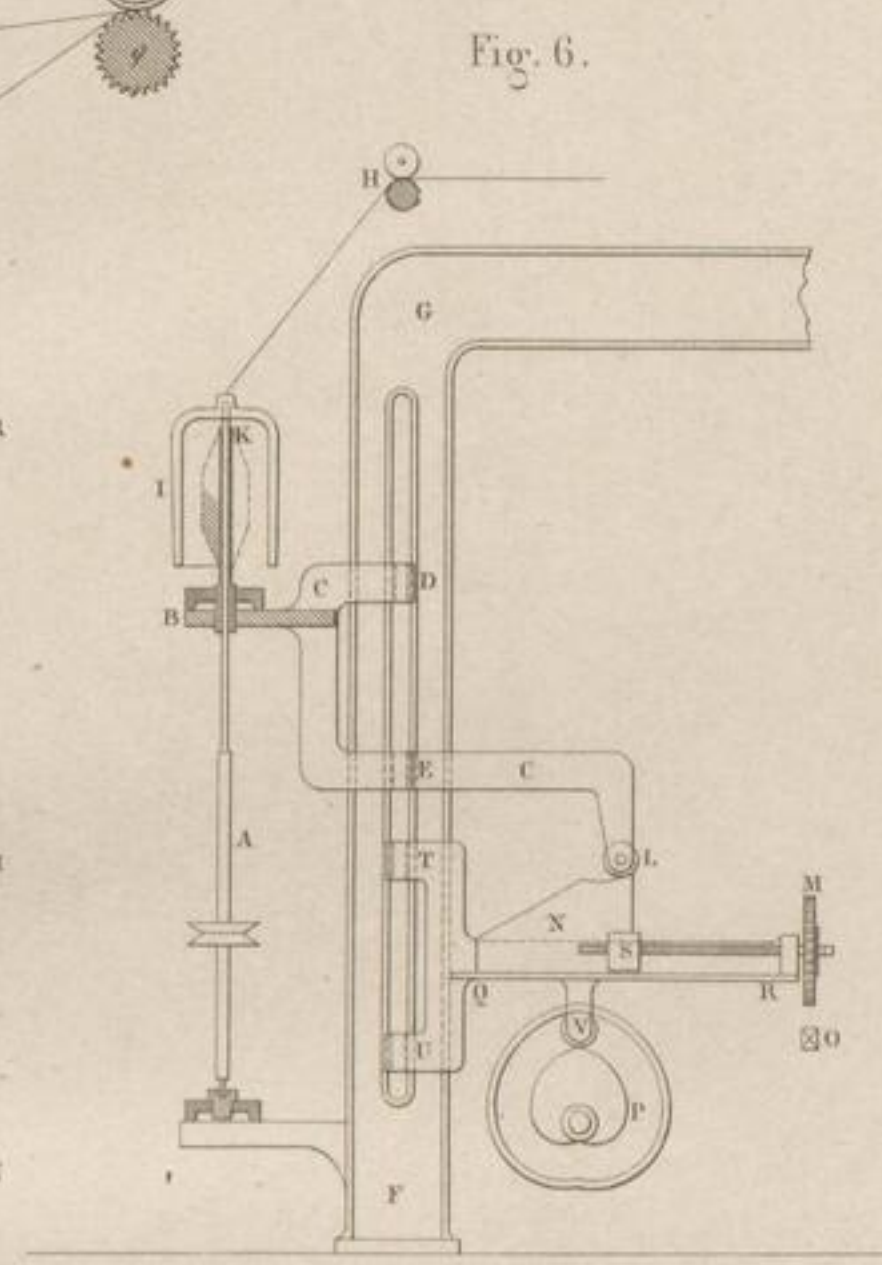

Fig. 6.

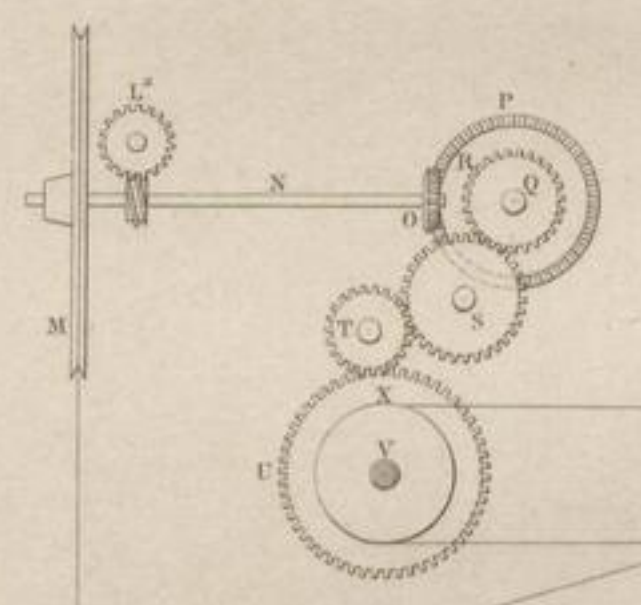

Fig. 5.

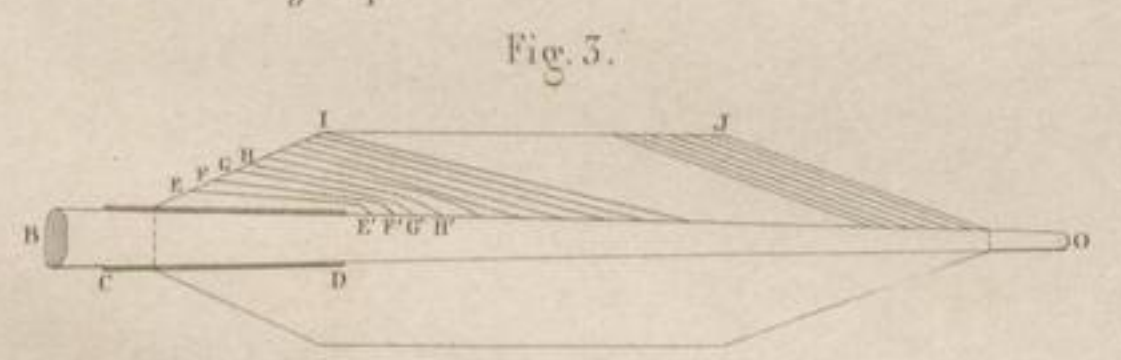

Fig. 3.

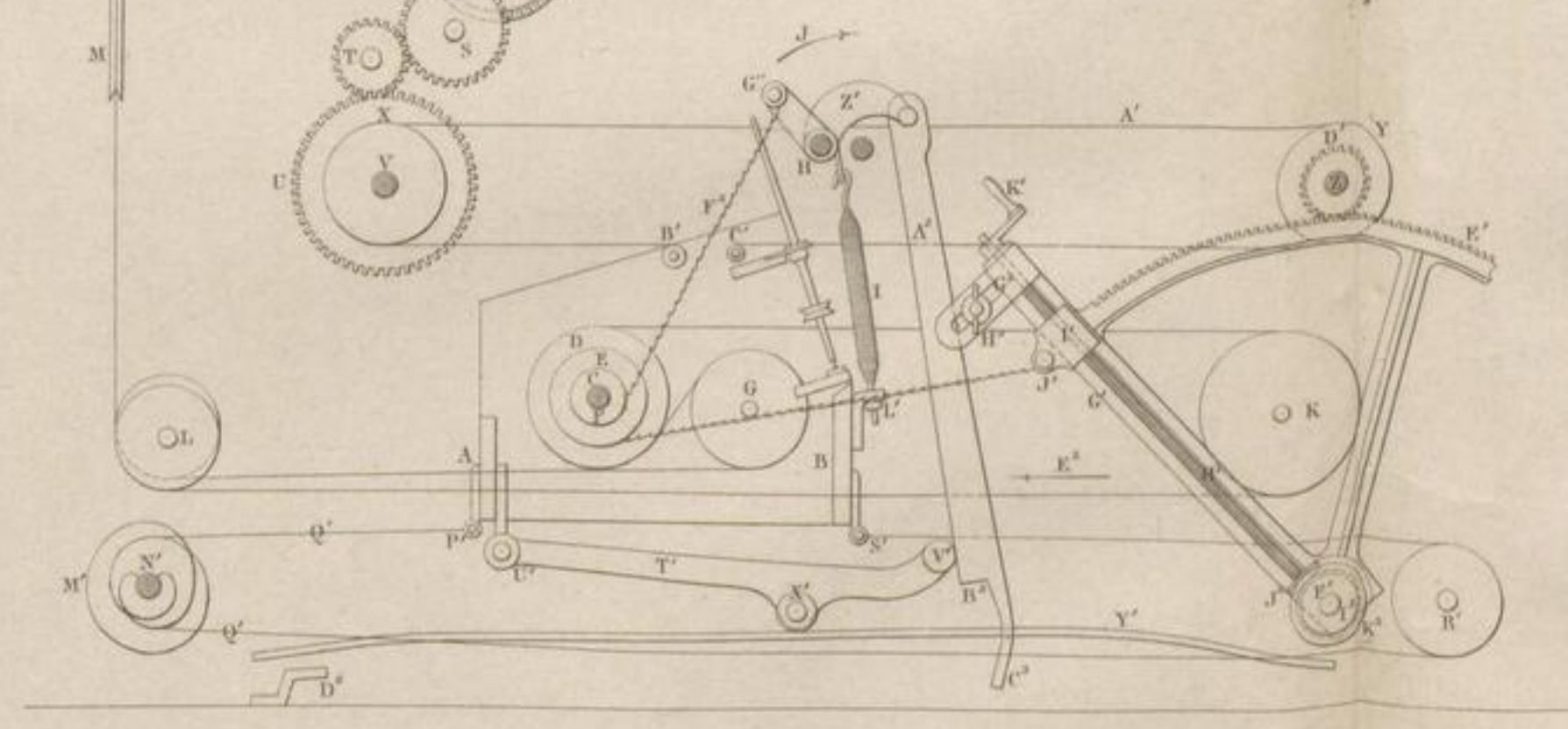

Fig. 4.

*Dessiné par Stamm.*

*Imp. Rouvier, 10, rue de Valenciennes, S<sup>t</sup>. Jacques, Paris.*

*Gravé par Le Blanc, s. S. Appoline, Paris.*











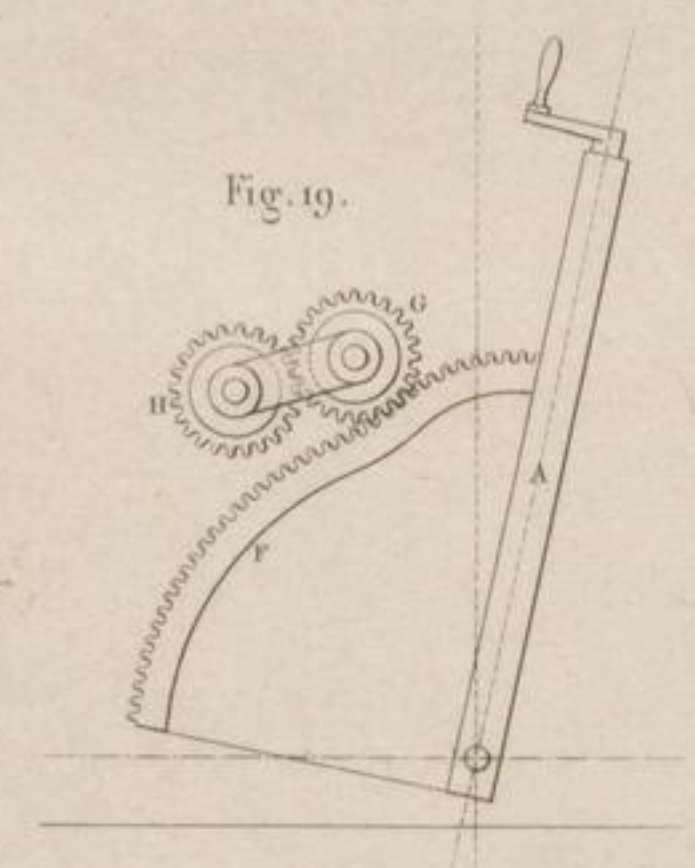
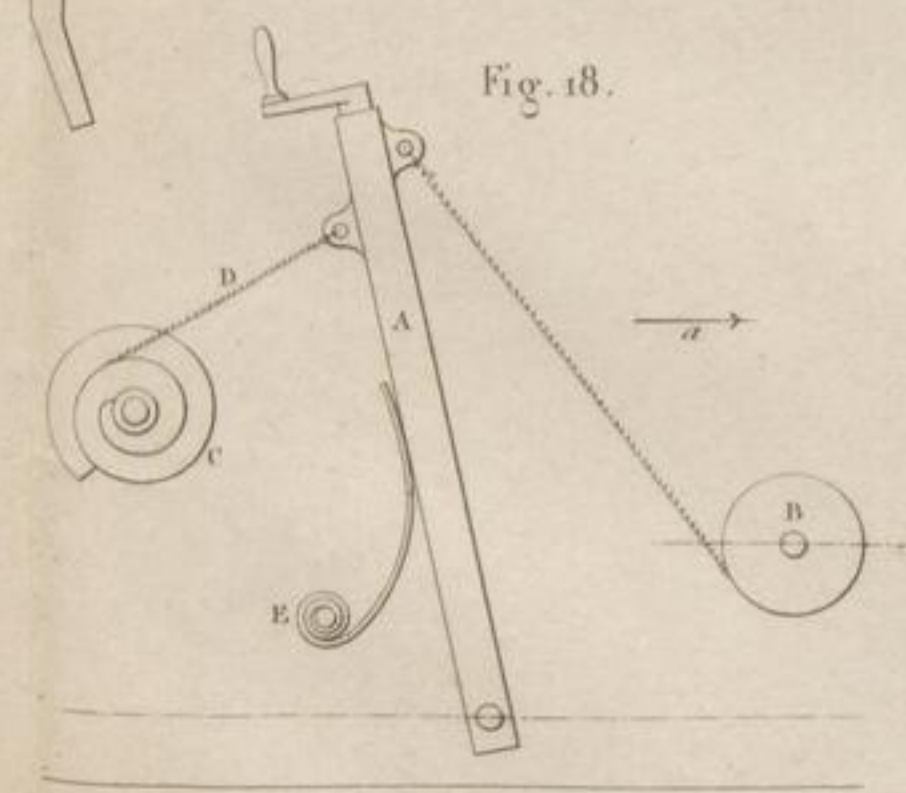
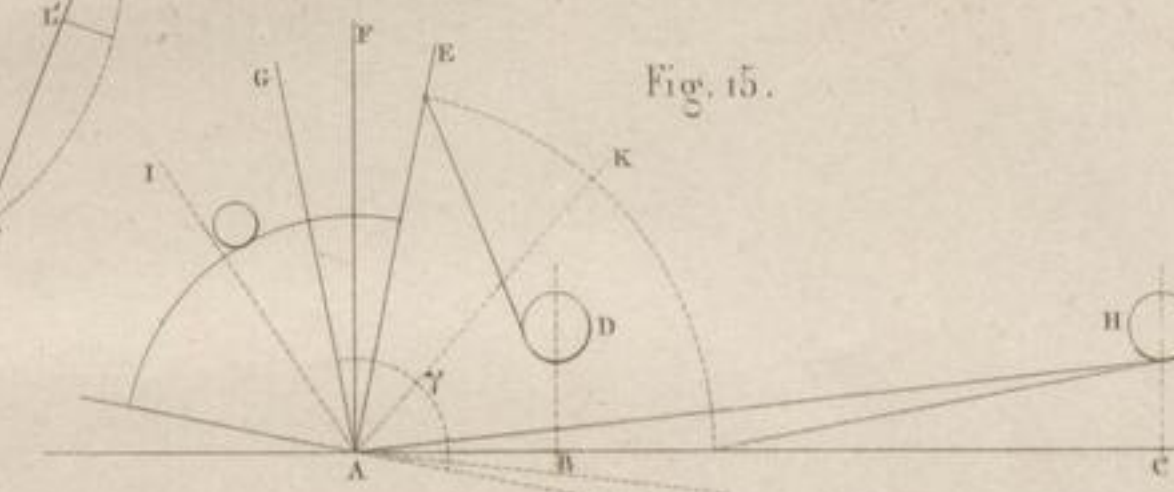
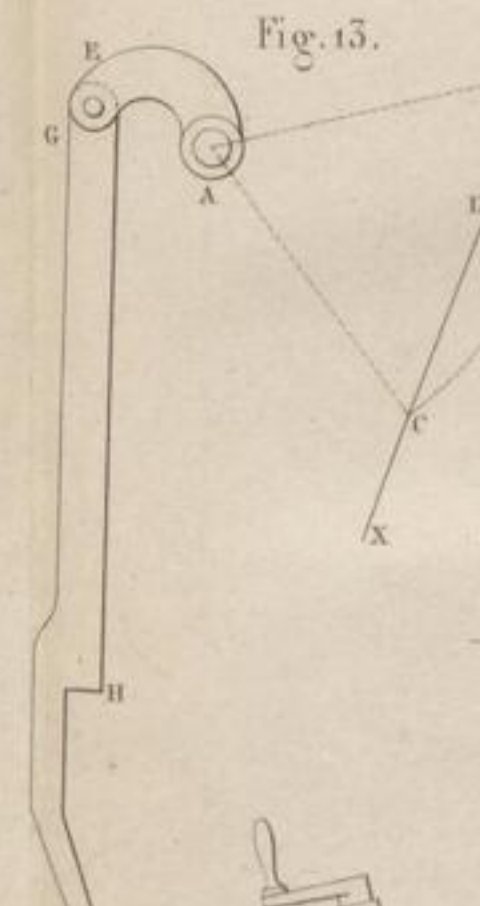
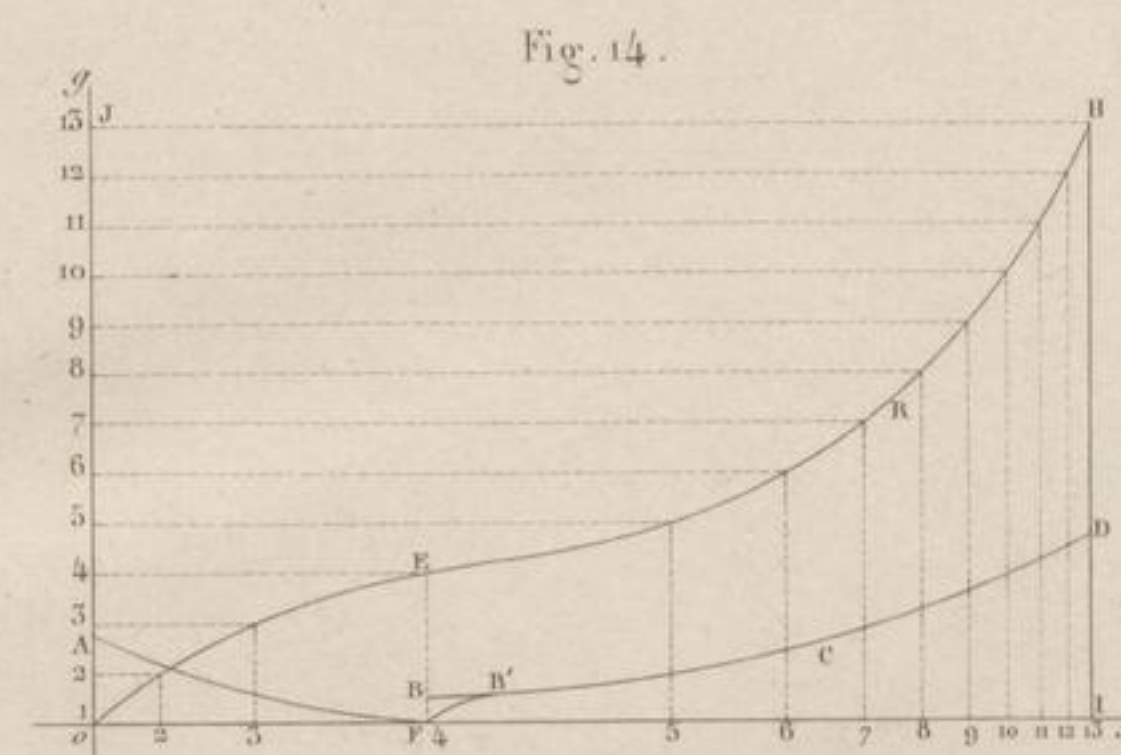
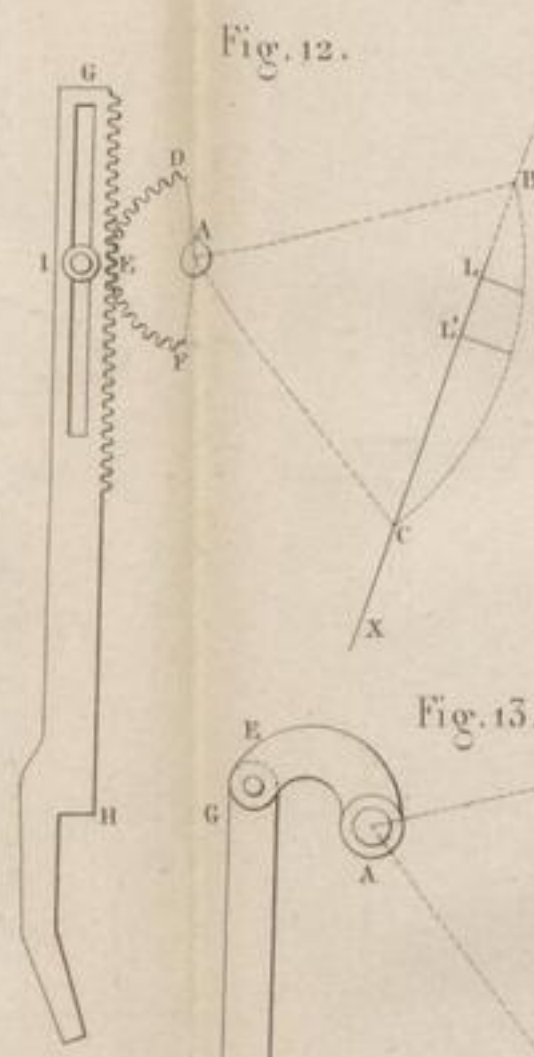
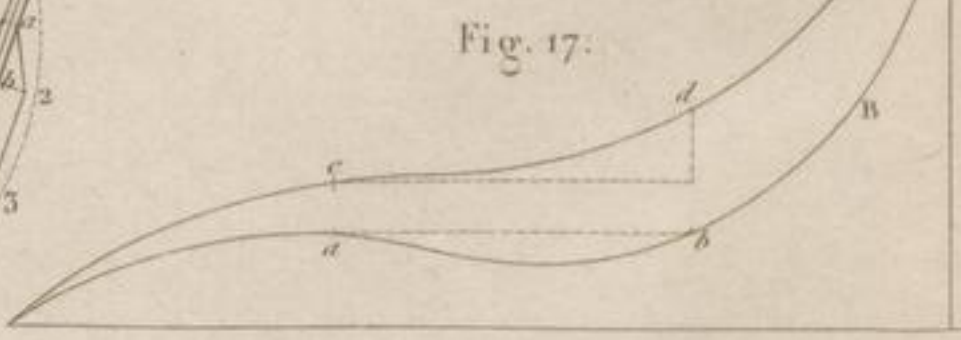
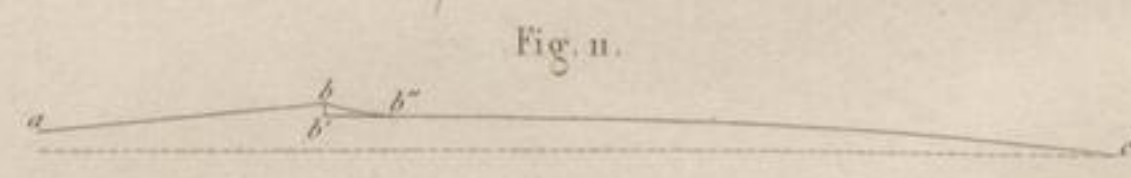
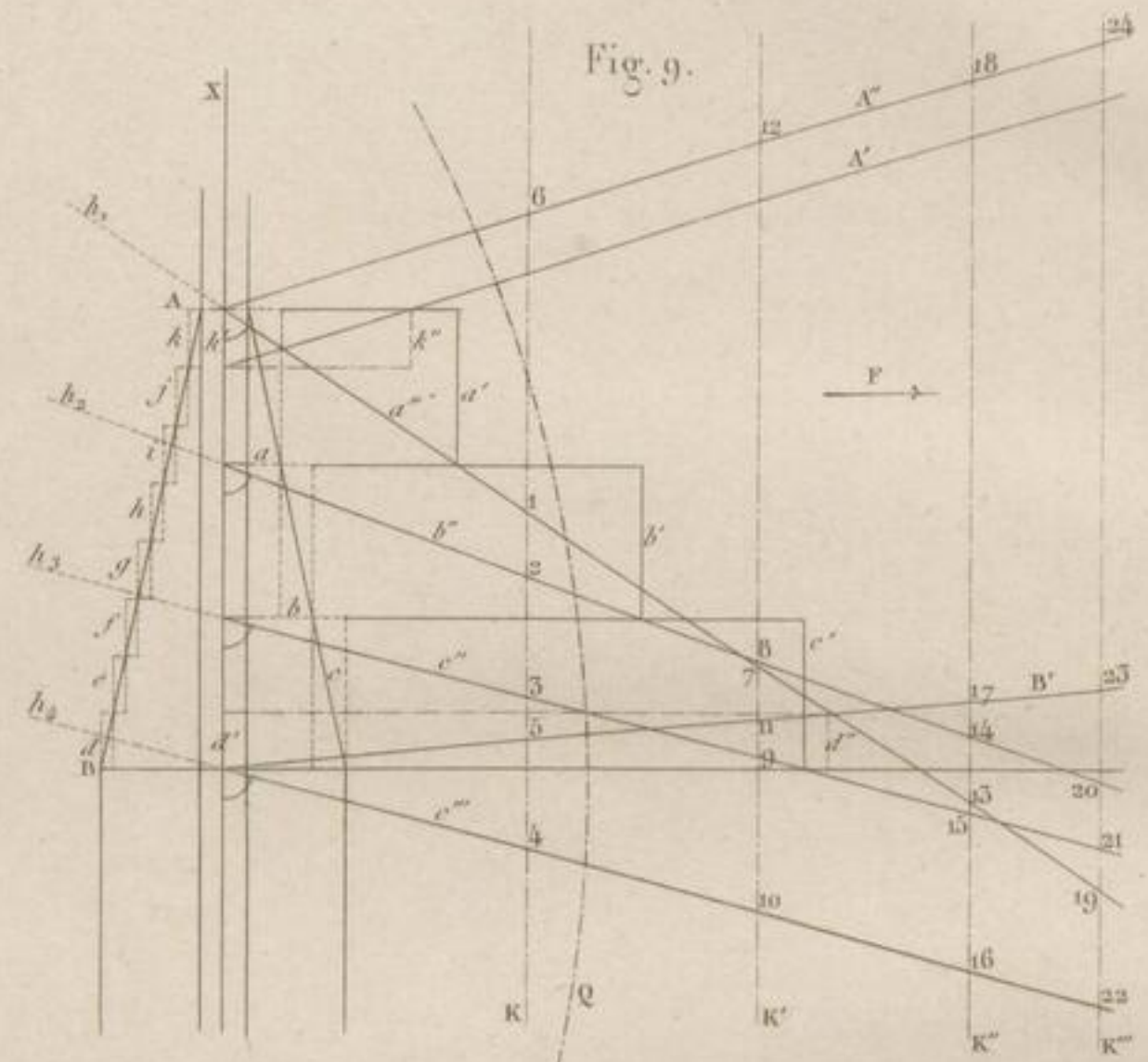
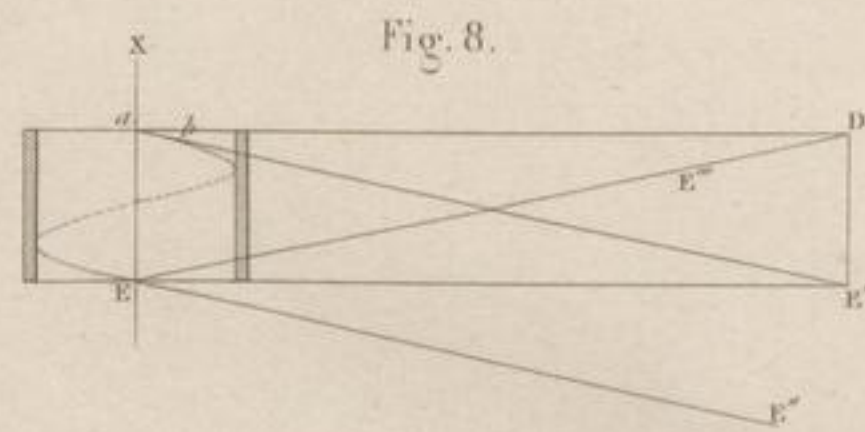

Dessiné par Stamm.

Gravé par Ad. Le Blanc, r. rue St. Appolin. Paris.







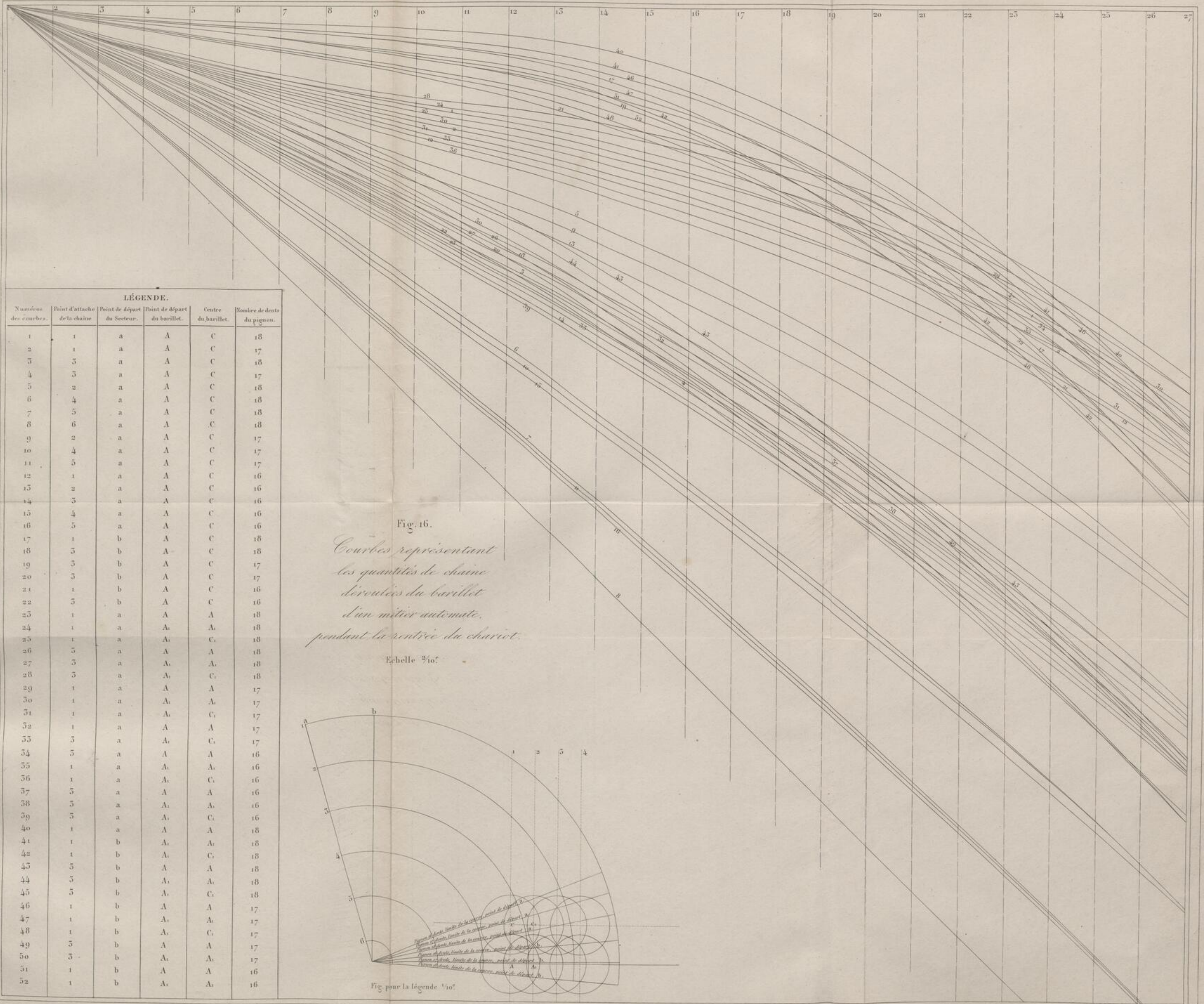

**LÉGENDE.**

Numéros des courbes.	Point d'attache de la chaîne	Point de départ du Secteur.	Point de départ du barillet.	Centre du barillet.	Nombre de dents du pignon.
1	1	a	A	C	18
2	1	a	A	C	17
3	3	a	A	C	18
4	3	a	A	C	17
5	2	a	A	C	18
6	4	a	A	C	18
7	5	a	A	C	18
8	6	a	A	C	18
9	2	a	A	C	17
10	4	a	A	C	17
11	5	a	A	C	17
12	1	a	A	C	16
13	2	a	A	C	16
14	3	a	A	C	16
15	4	a	A	C	16
16	5	a	A	C	16
17	1	b	A	C	18
18	3	b	A	C	18
19	3	b	A	C	17
20	3	b	A	C	17
21	1	b	A	C	16
22	3	b	A	C	16
23	1	a	A	A	18
24	1	a	A	A	18
25	1	a	A	C	18
26	3	a	A	A	18
27	3	a	A	A	18
28	3	a	A	C	18
29	1	a	A	A	17
30	1	a	A	A	17
31	1	a	A	C	17
32	1	a	A	A	17
33	3	a	A	C	17
34	3	a	A	A	16
35	1	a	A	A	16
36	1	a	A	C	16
37	3	a	A	A	16
38	3	a	A	A	16
39	3	a	A	C	16
40	1	a	A	A	18
41	1	b	A	A	18
42	1	b	A	C	18
43	3	b	A	A	18
44	3	b	A	A	18
45	3	b	A	C	18
46	1	b	A	A	17
47	1	b	A	A	17
48	1	b	A	C	17
49	3	b	A	A	17
50	3	b	A	A	17
51	1	b	A	A	16
52	1	b	A	A	16

Fig. 16.  
 Courbes représentant  
 les quantités de chaîne  
 déroulées du barillet  
 d'un métier automate,  
 pendant la rentrée du chariot.

Echelle 2/10.

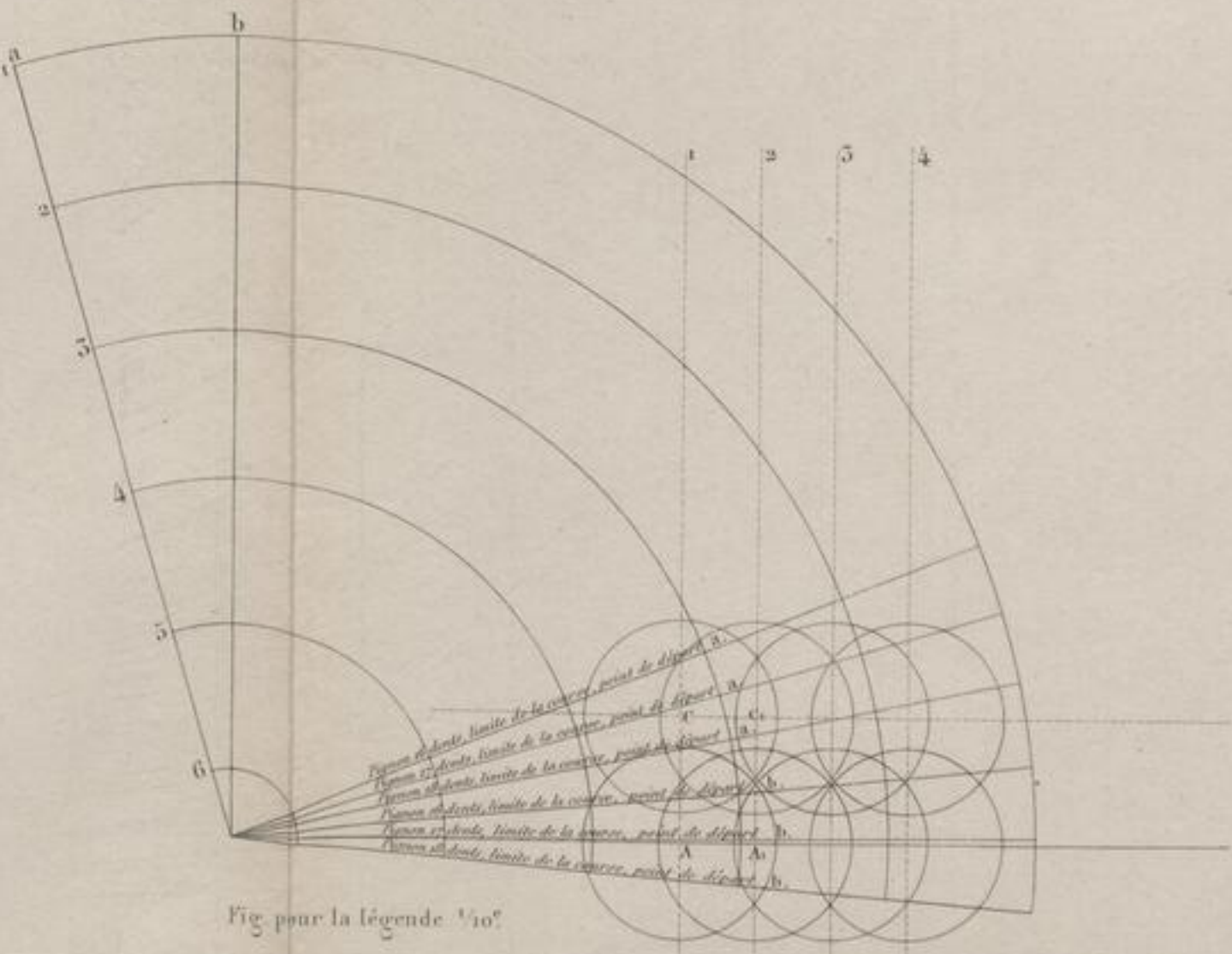

Fig. pour la légende 1/10.

Desiné par Stamm

Gravé par M. de Blane, à Paris, chez M. Agache, Paris











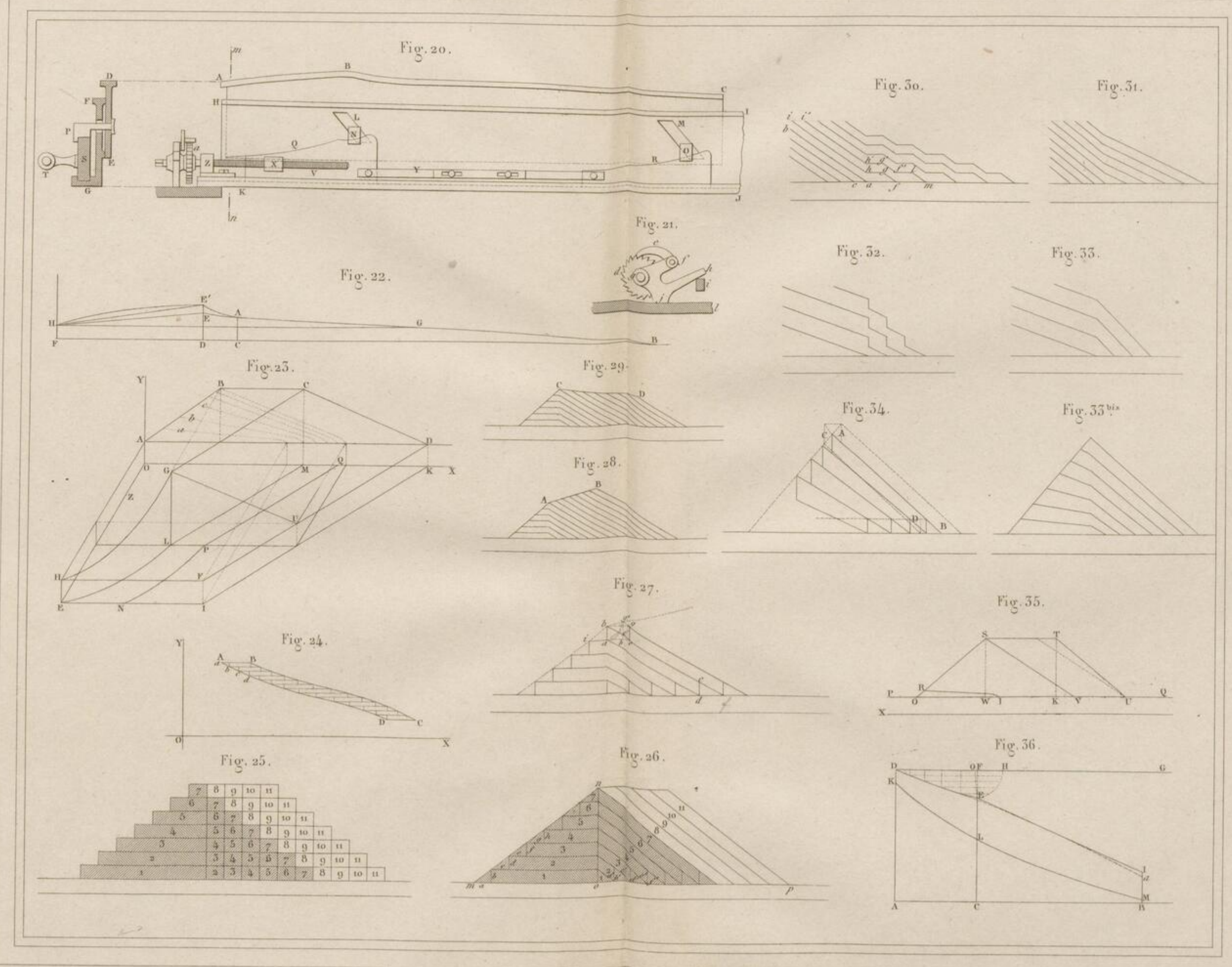

Dessiné par Stamm.

Gravé par Ad. Le Blanc, r. rue St. Appoline, Paris.











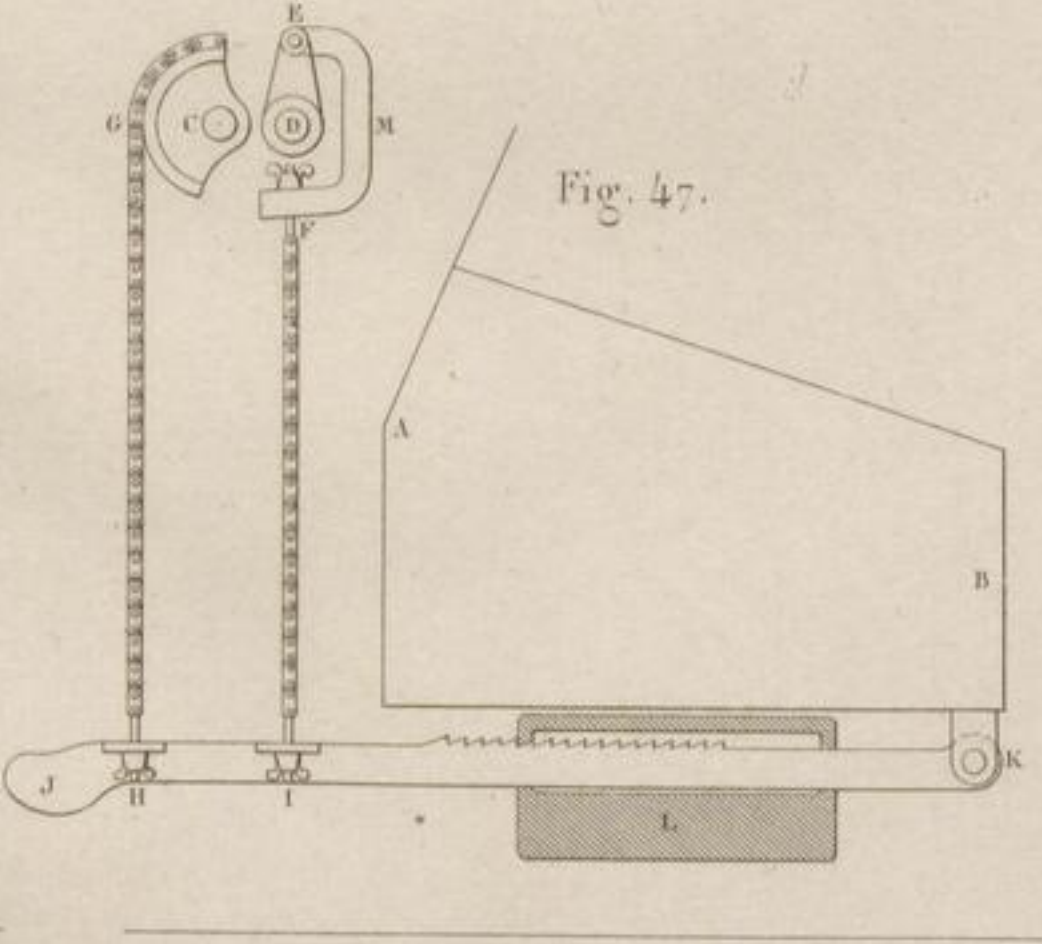
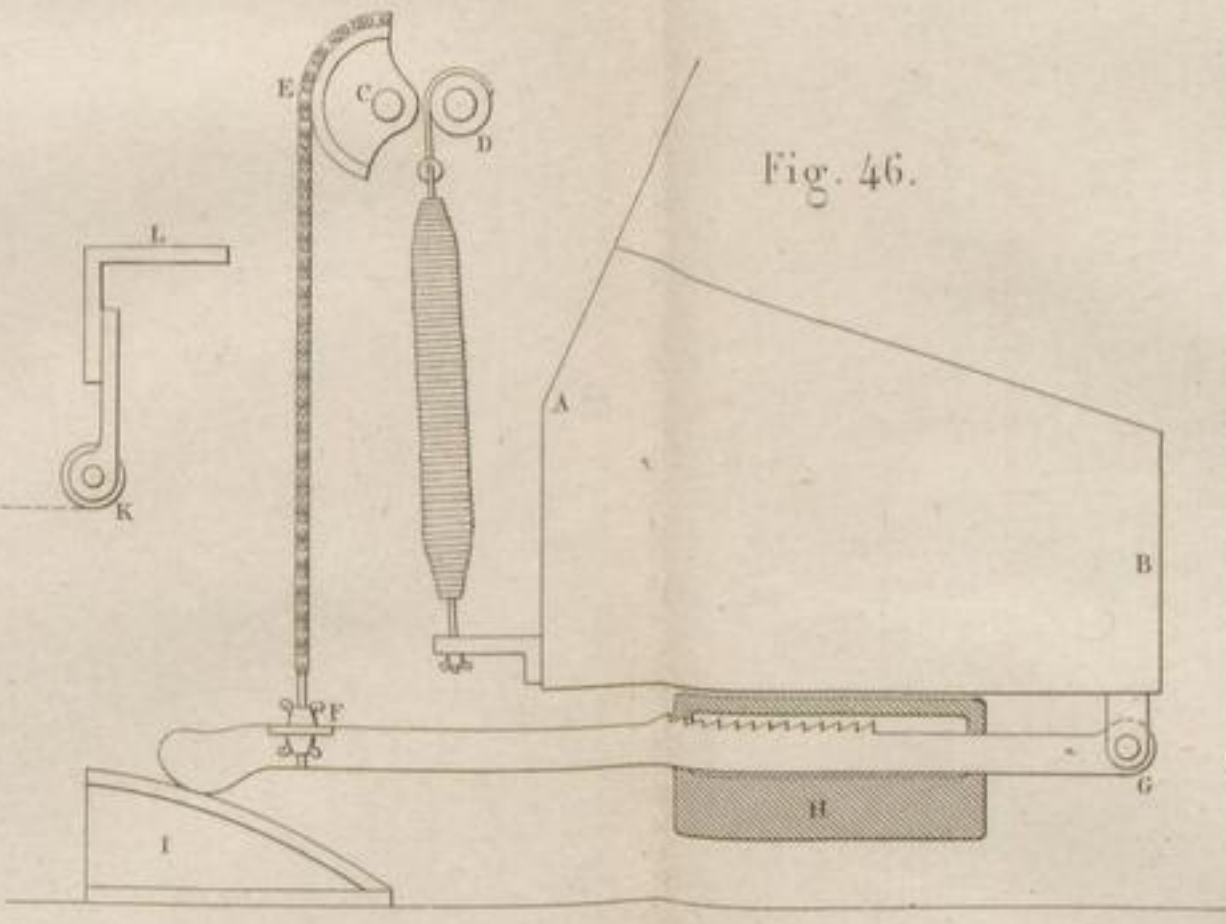
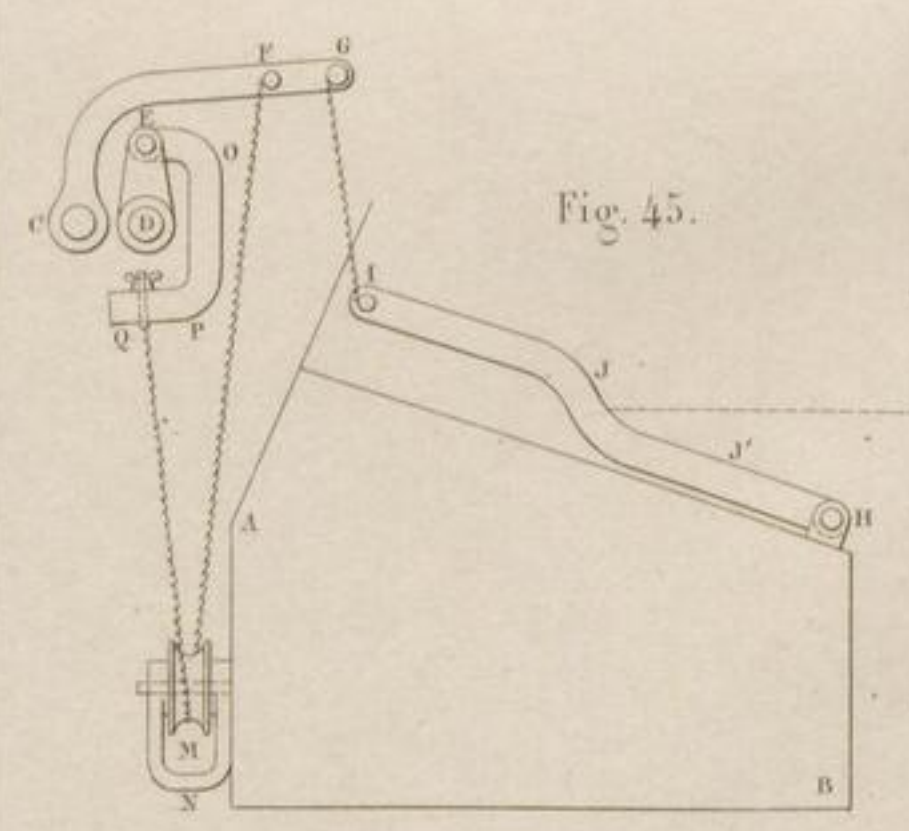
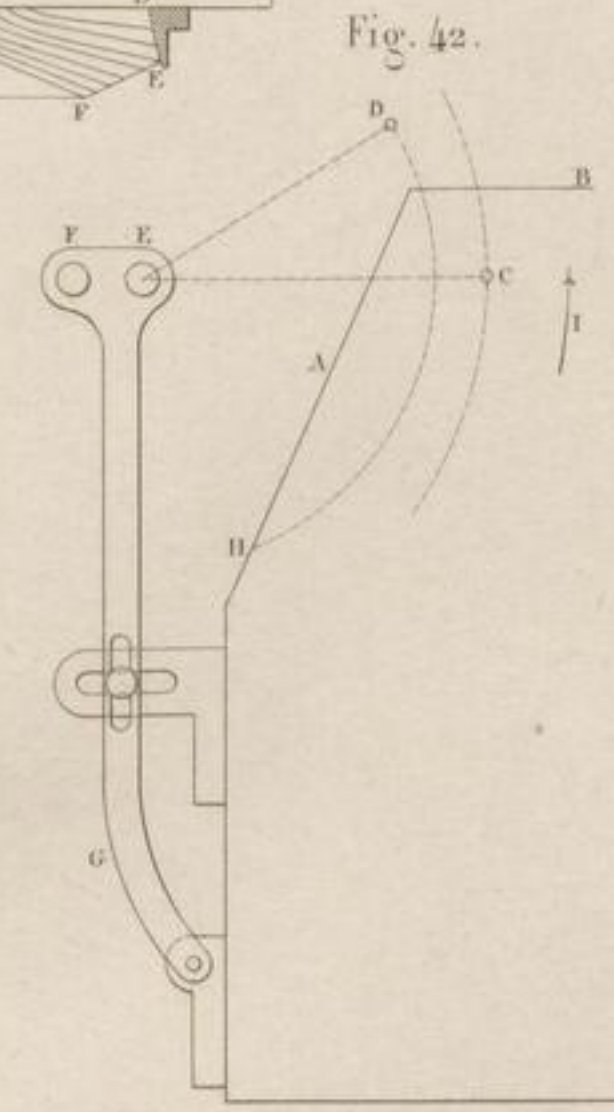
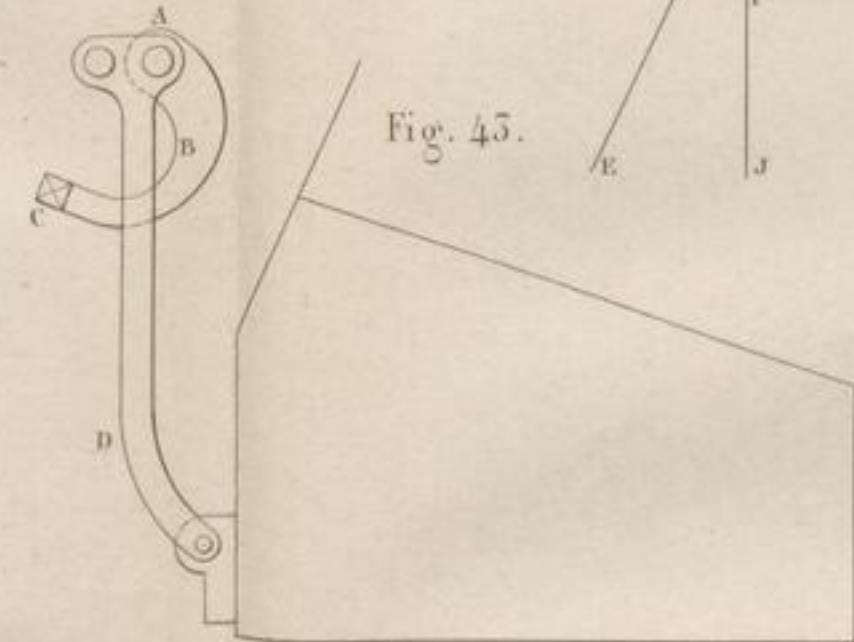
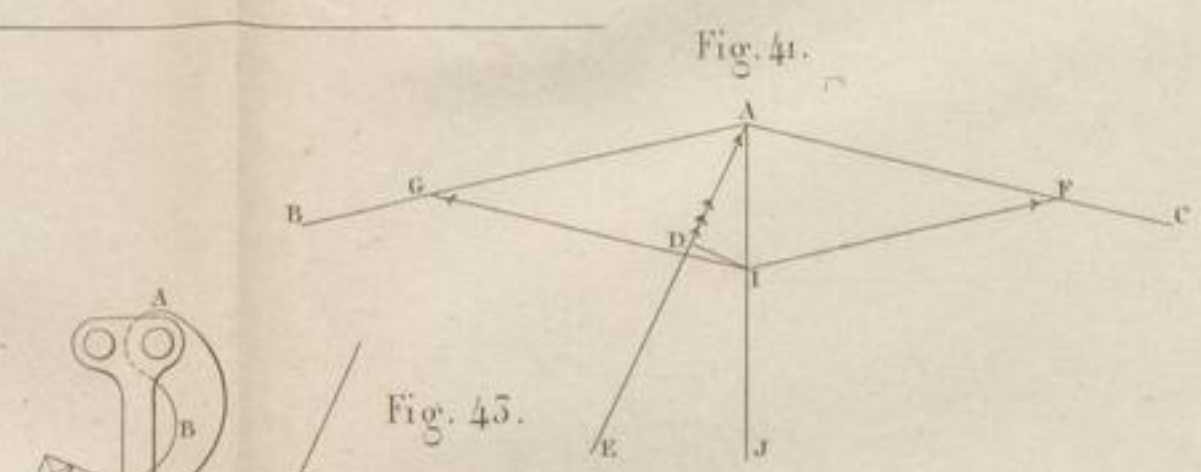
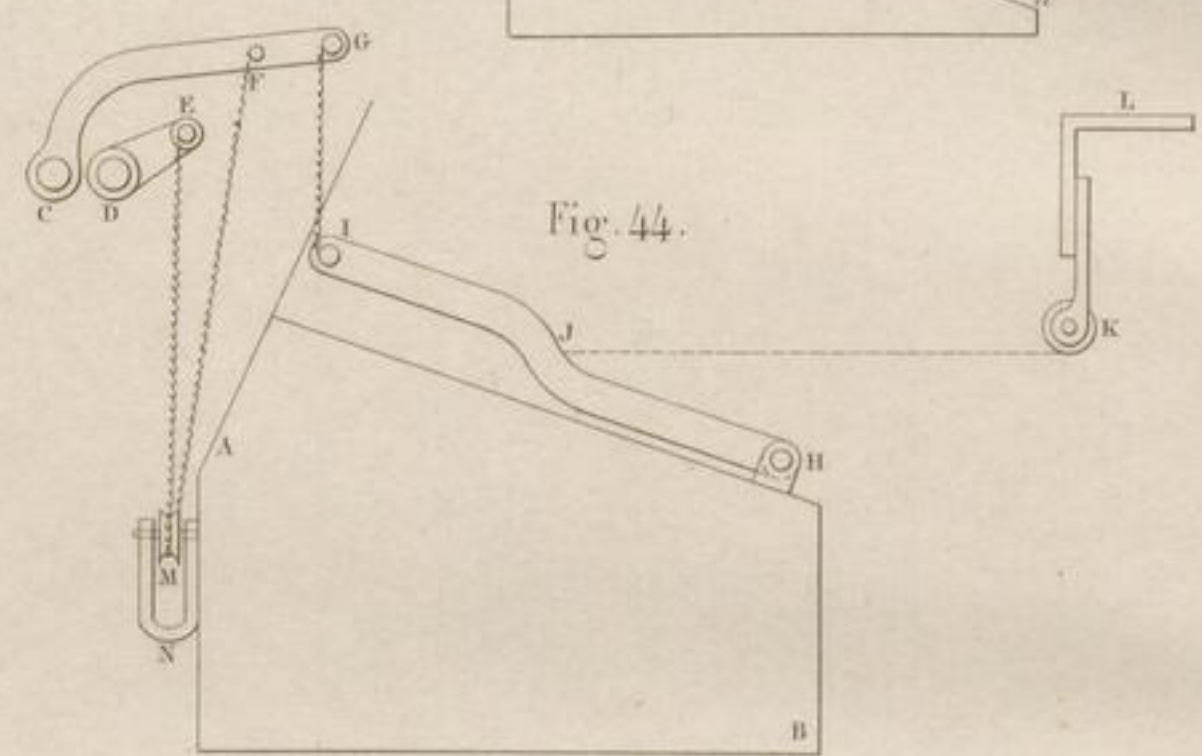
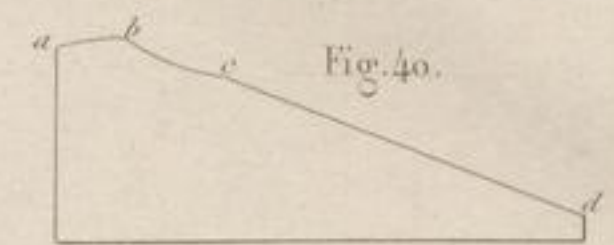
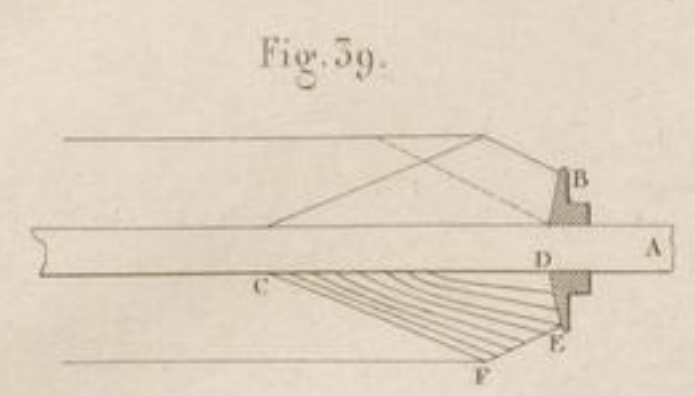
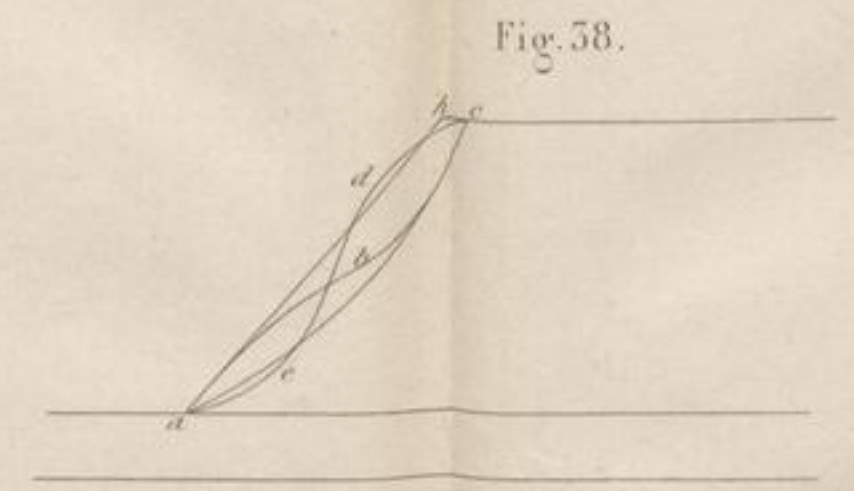
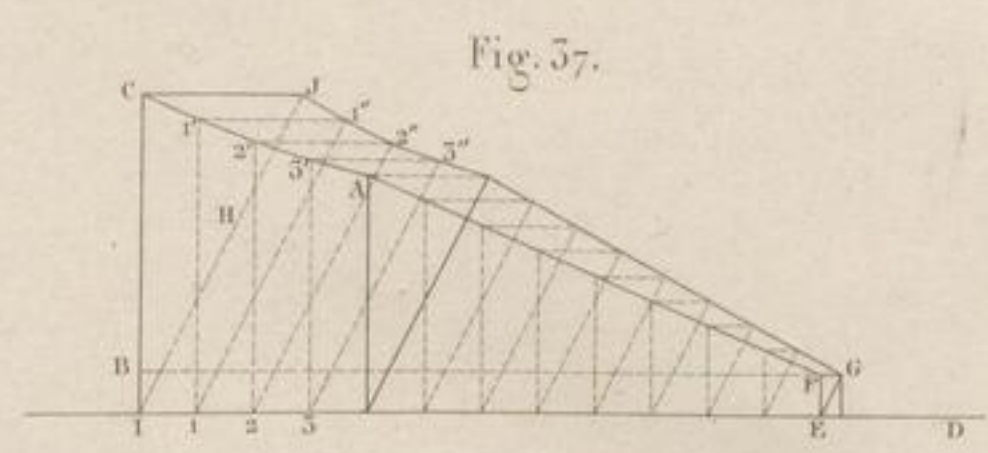

*Dessiné par Stamm.*

*Gravé par Ad. Le Blanc à rue S. Apolline, Paris.*











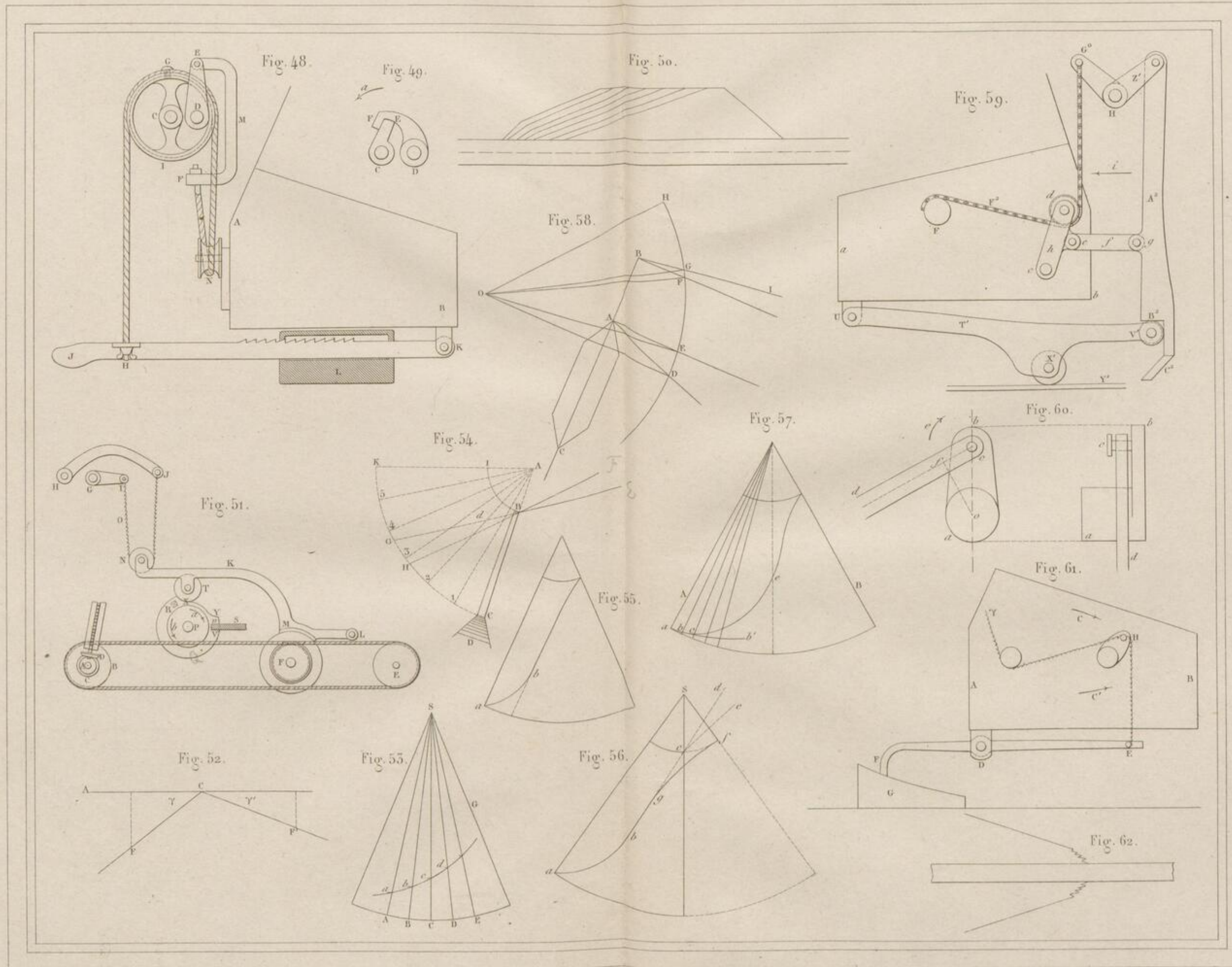

Dessiné par Stamm.

Gravé par Ad. Le Blanc, chez S'Appaher, Paris.











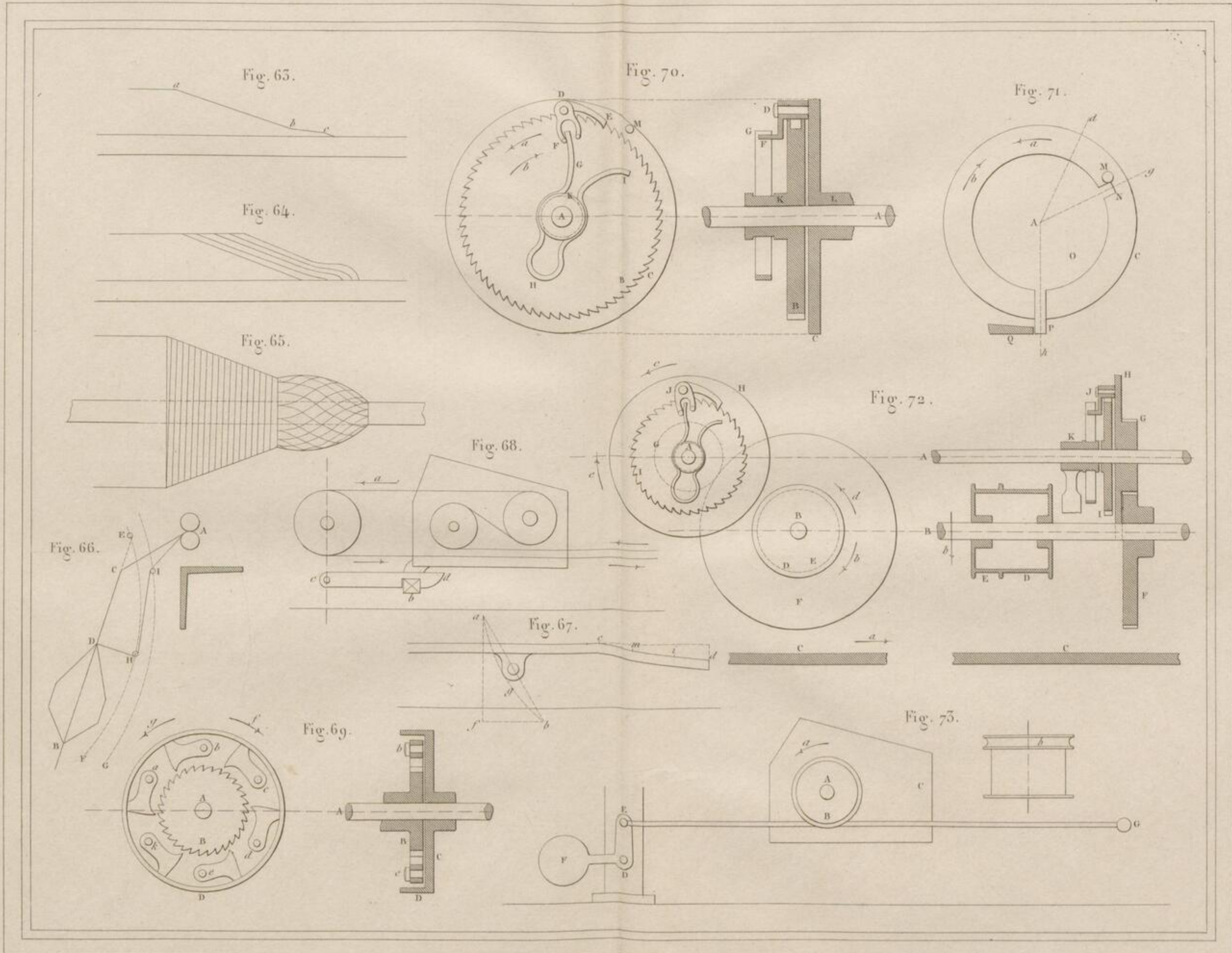

Designé par Stamm.

Gravé par Ad. Le Blanc, à rue S. Appoline, Paris.











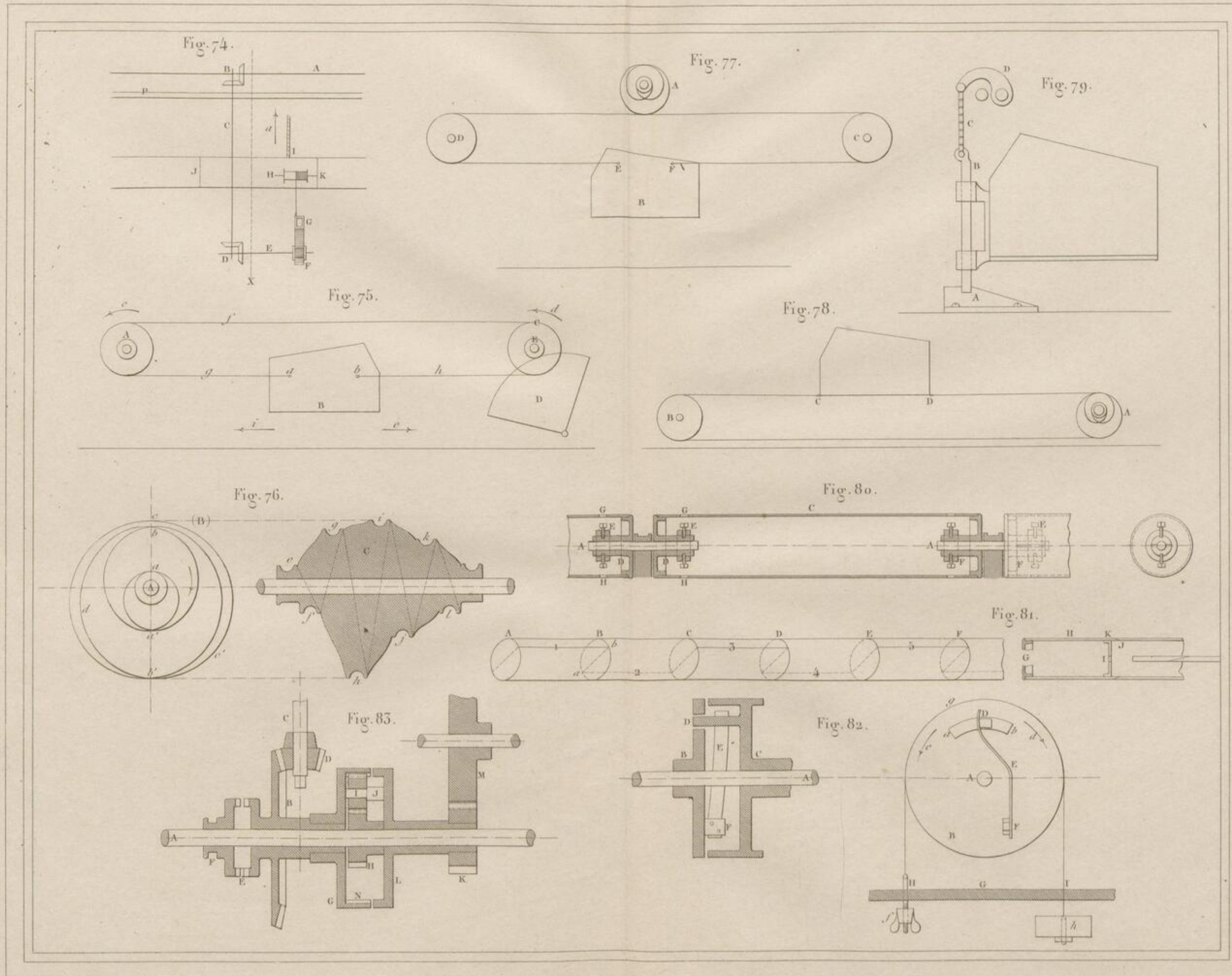

Desiné par Stamm.

Gravé par Ad. Le Blanc, r. rue St. Antoine Paris.











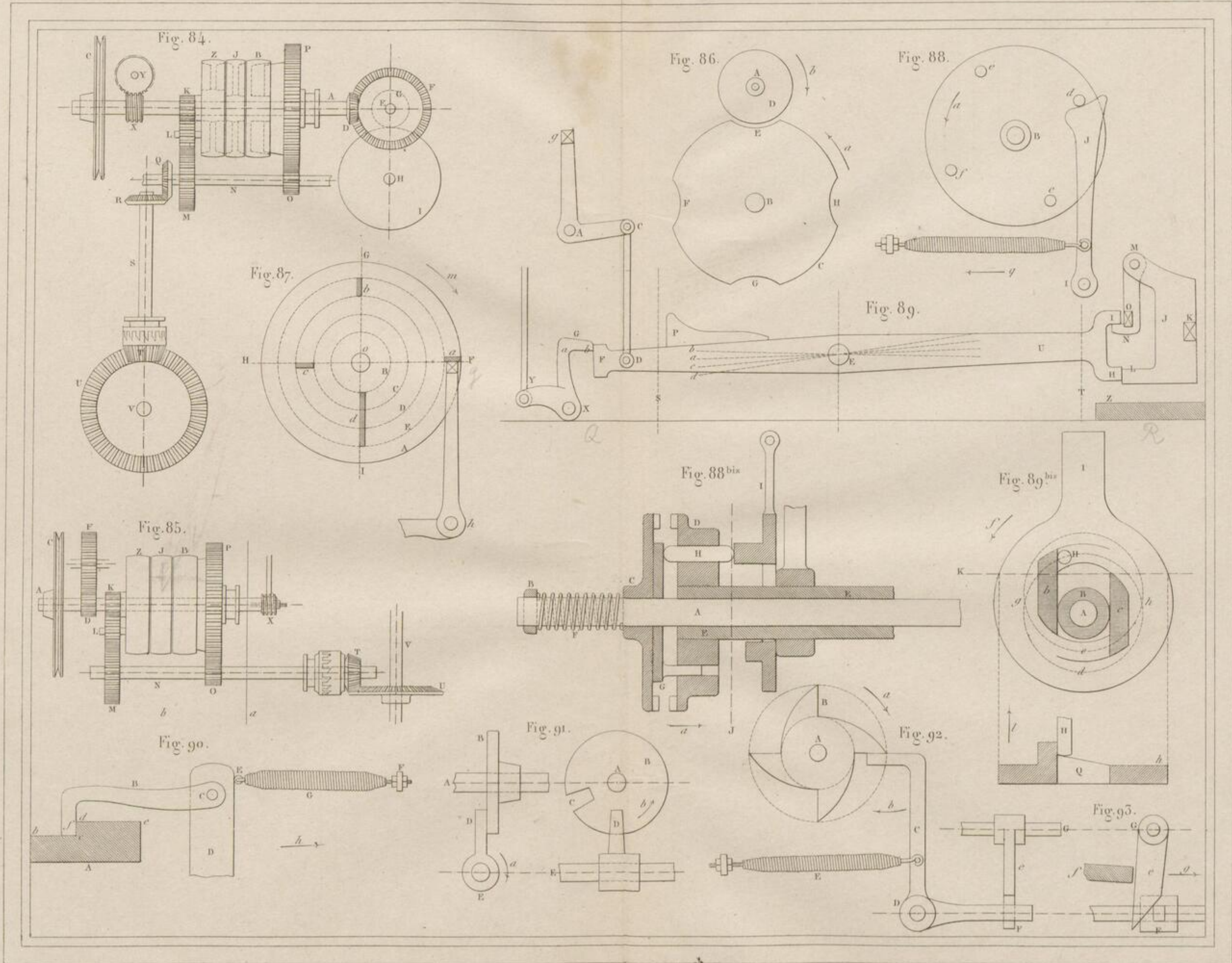

Dessiné par Stamm.

Gravé par Ad. Le Blanc, r. rue S. Apollon Paris.











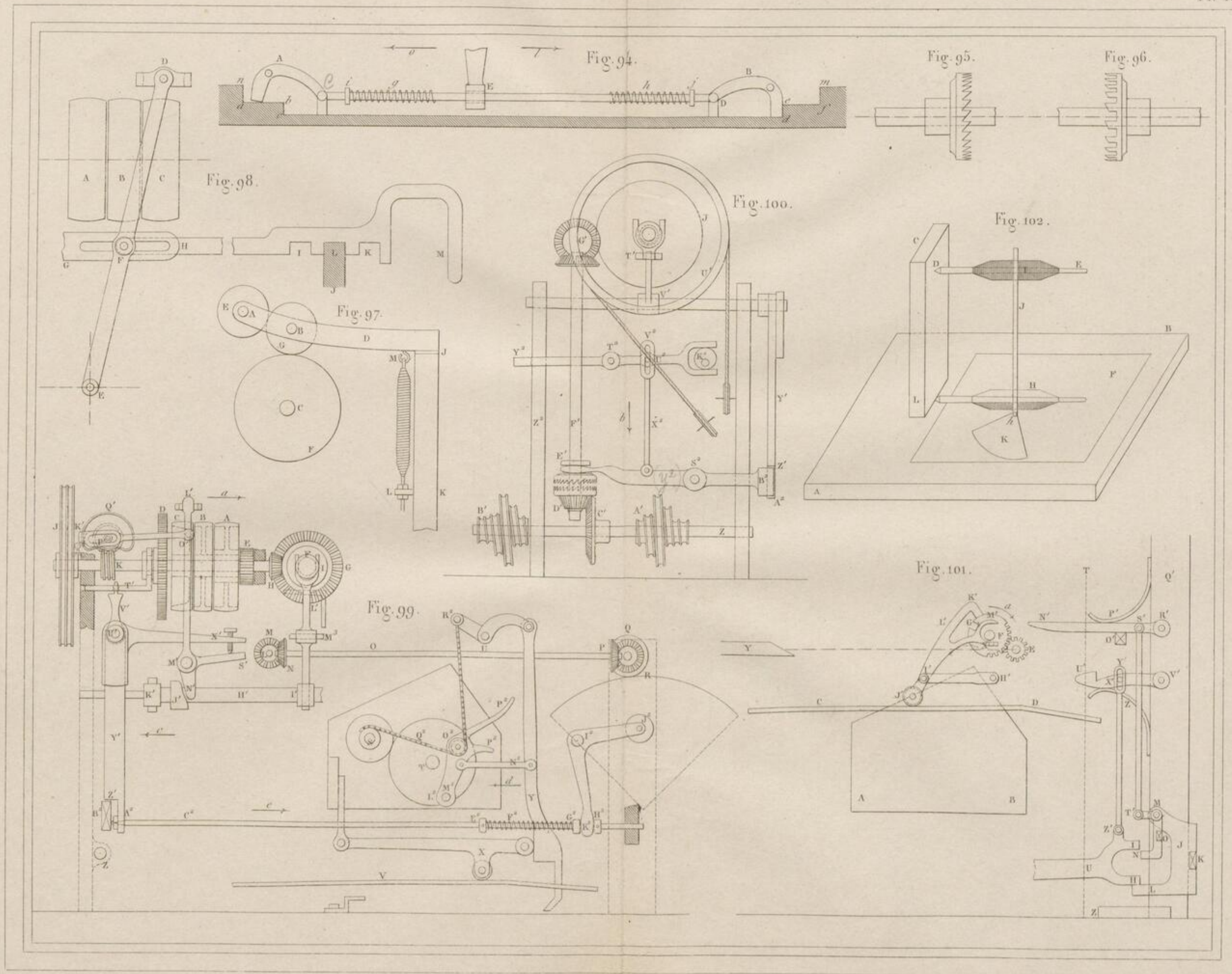

Designé par Stamm.

Gravé par Ad. Le Blanc, à rue S. Appoline, Paris.



















10