













# Atlas

zu

## Dingler's polytechnisches Journal.

Band 237.

(Einundsechzigster Jahrgang.)

Jahrgang 1880.

---

Enthaltend 37 lithographirte Tafeln.

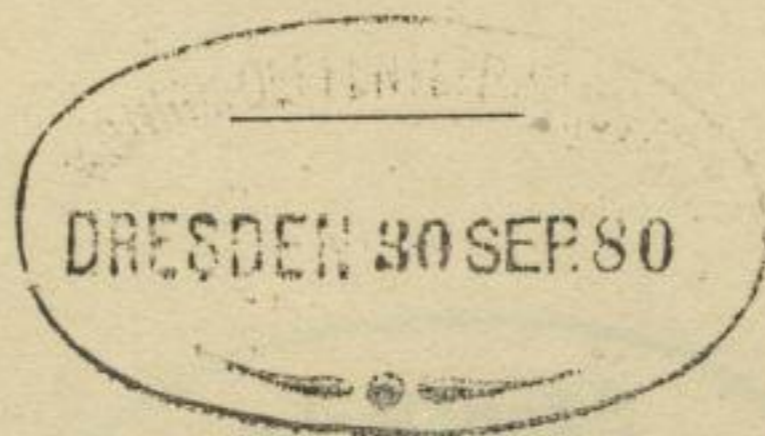

Augsburg.

Druck und Verlag der J. G. COTTA'schen Buchhandlung.















Uhlhorn's halbgeschränkter Riementrieb mit zwei Leitrollen. (1 u 2)

Lemut's Einladevorrichtung. (3 u 4)

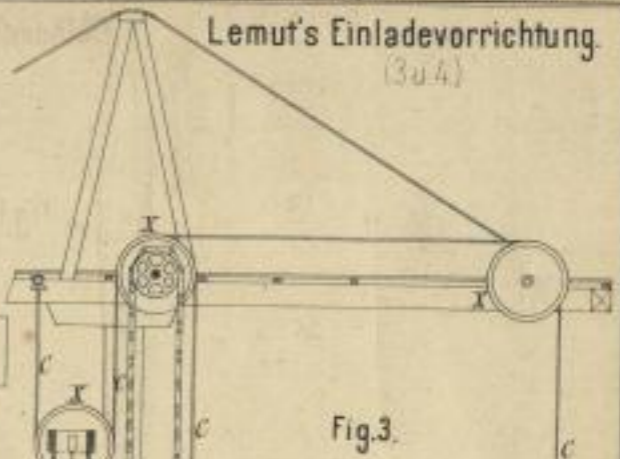
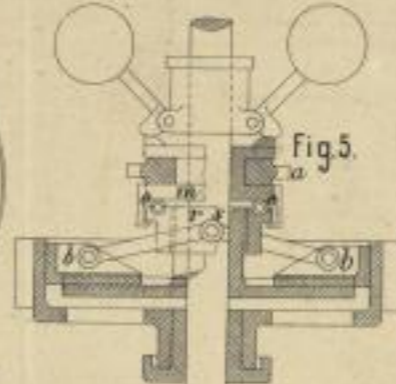
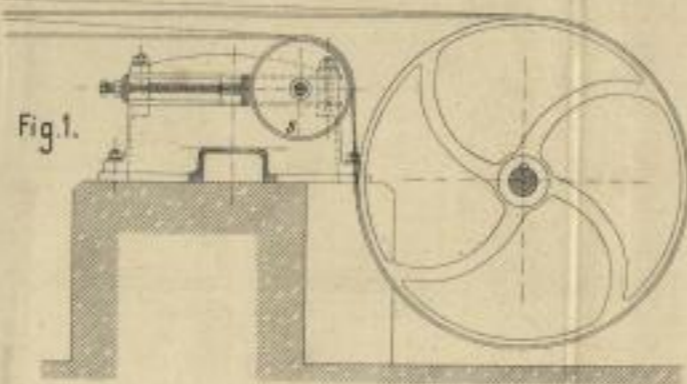
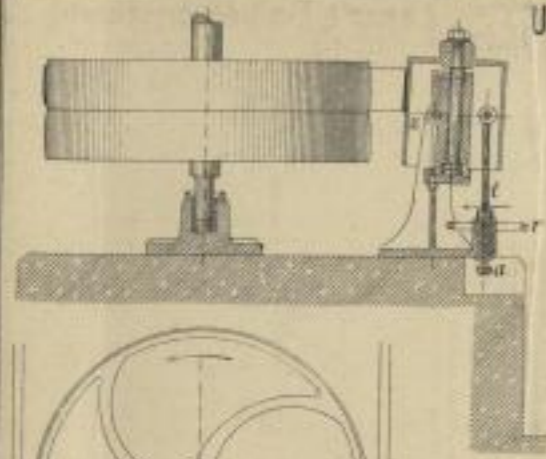

Stoltenberg's und Féral's Wegmesser für Fuhrwerke. (7-11 bez 12 u 13)

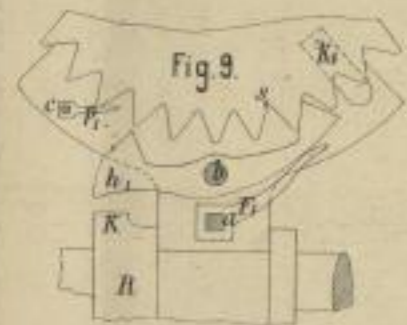
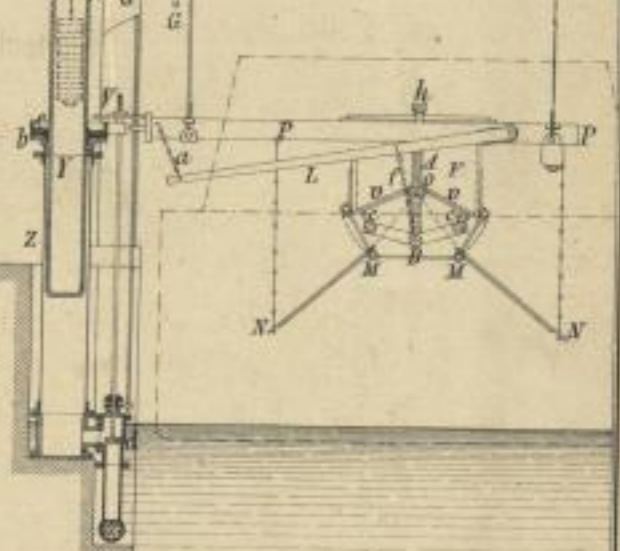
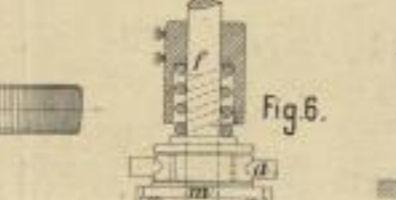
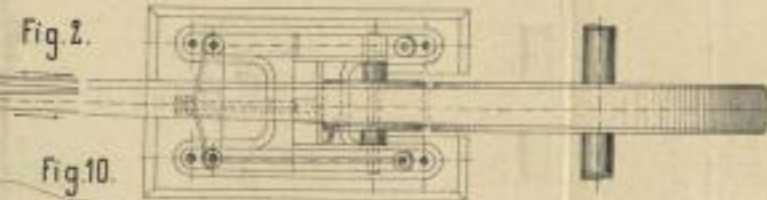

R. Steiner's Reibungskupplung. (5 u 6)

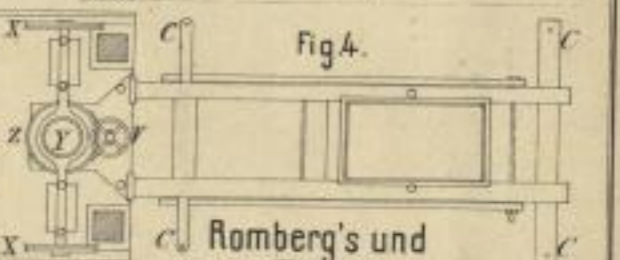
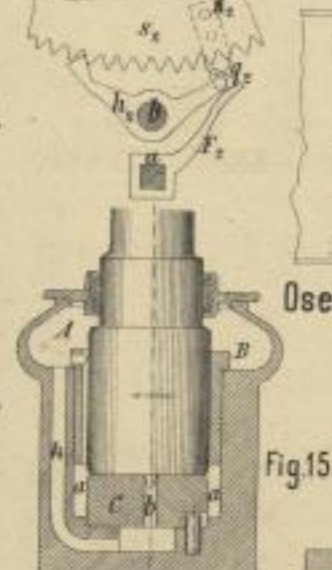
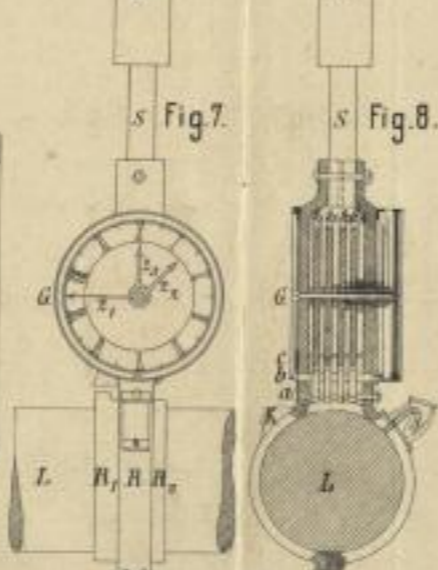
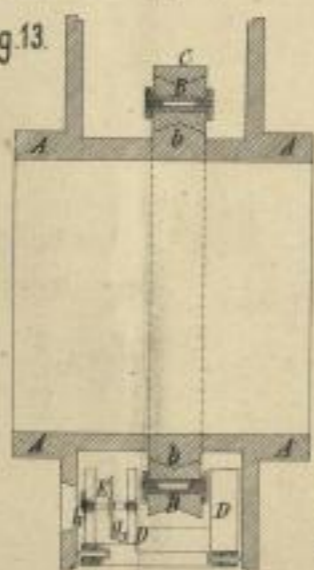
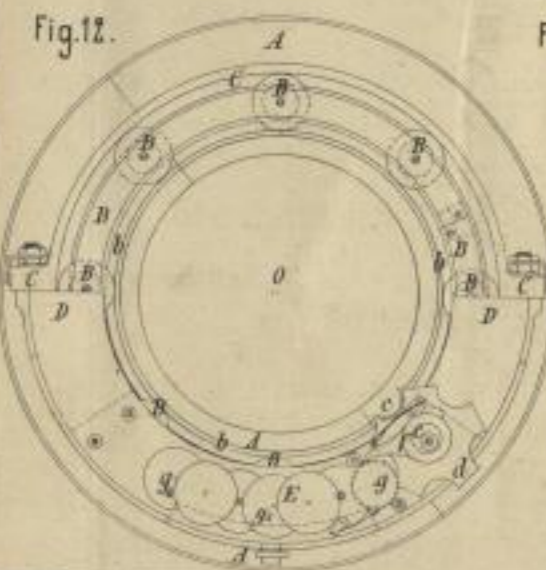
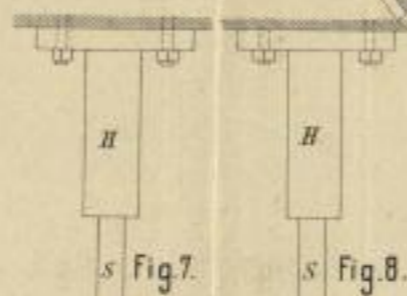

Romberg's und Osenbrück's Schmierapparate. (14 u 15)

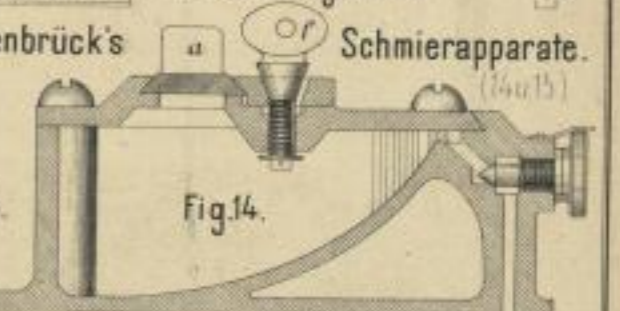
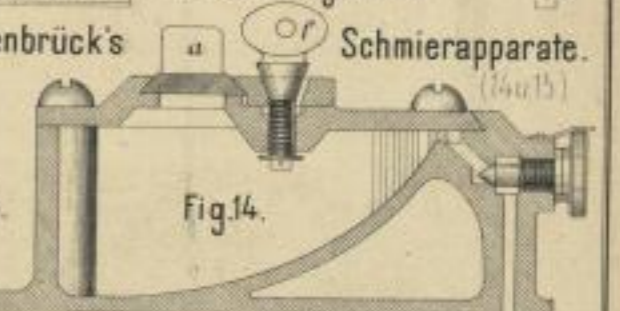

Lith. Anst. v. F. W. W. Darmstadt.



Erdmann's Trio-Walzenständer (1-6)

Fig. 1.

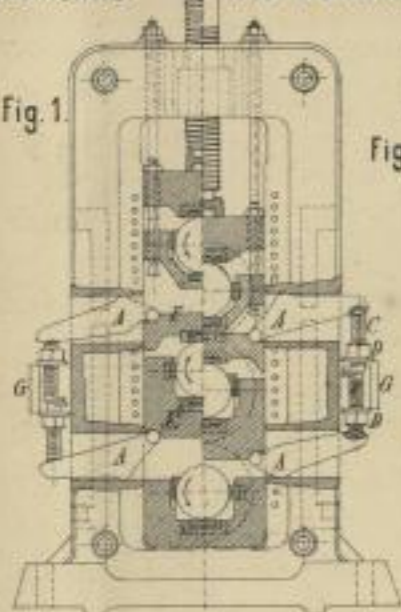

Fig. 3.

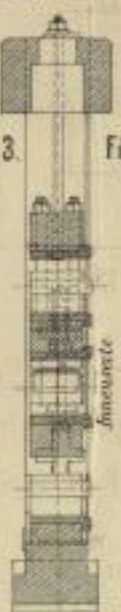

Fig. 4.

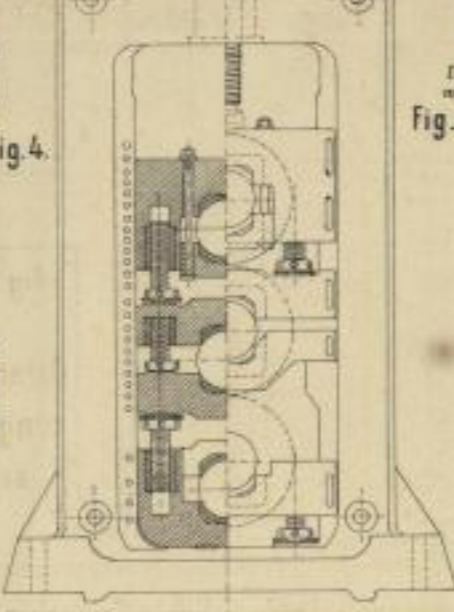

Fig. 6.

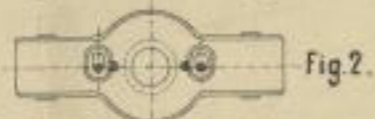
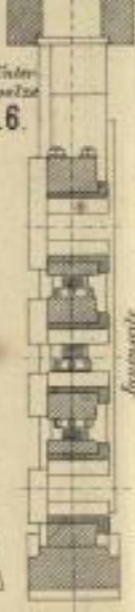

Fig. 2.

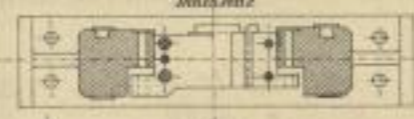

Fig. 5.

R. M. Daelen's Richtpresse (7-8)

Fig. 7.

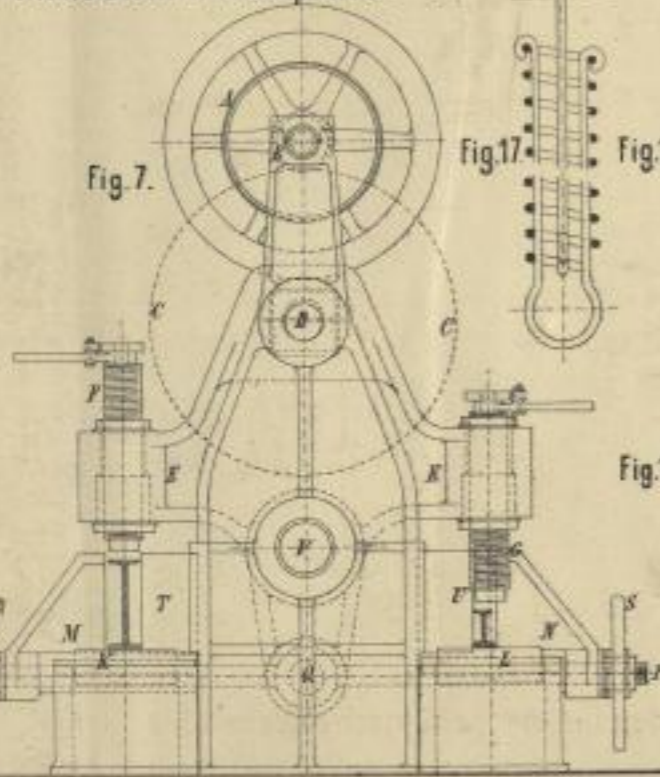

Fig. 17.

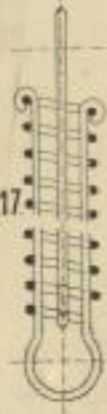

Fig. 18.

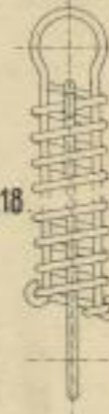

Fig. 19.

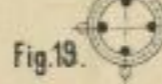
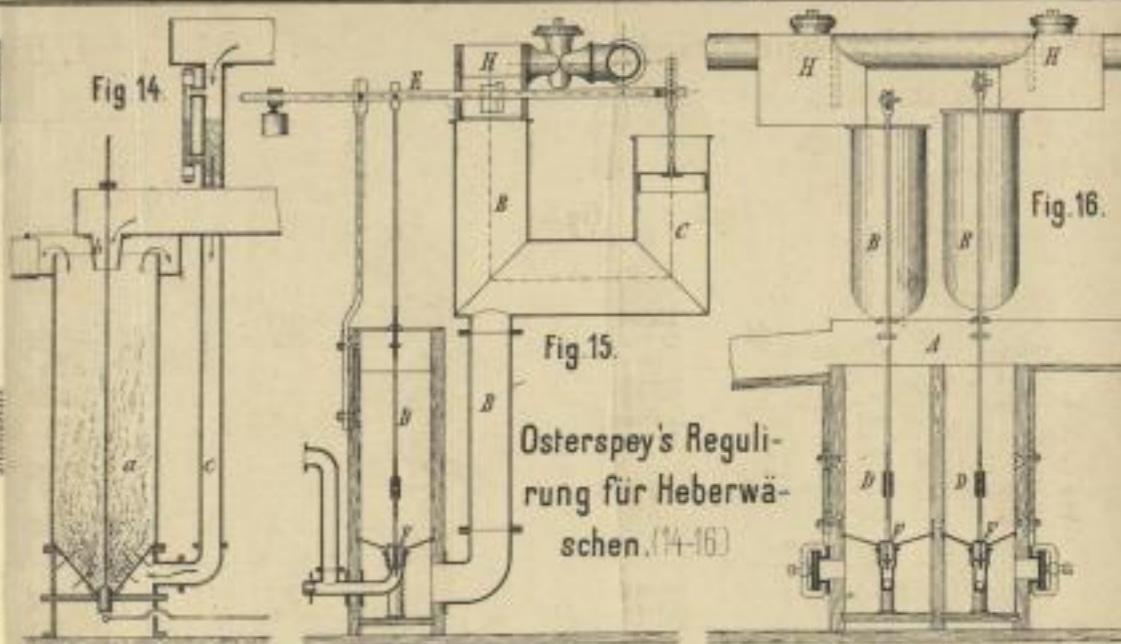
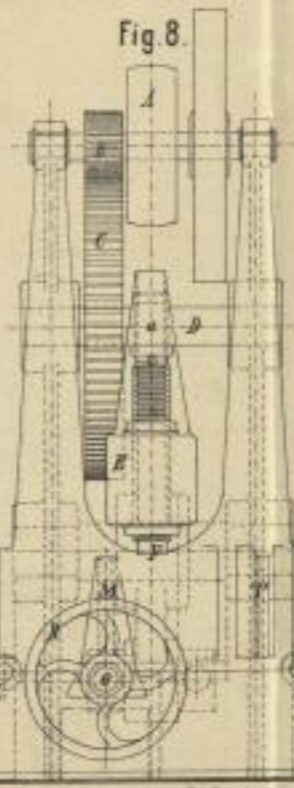

Fig. 8.



Kreuzberger's Fräsen-Schleifmaschine (9-13)

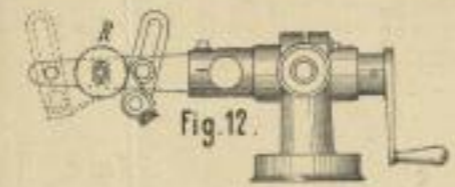

Fig. 12.

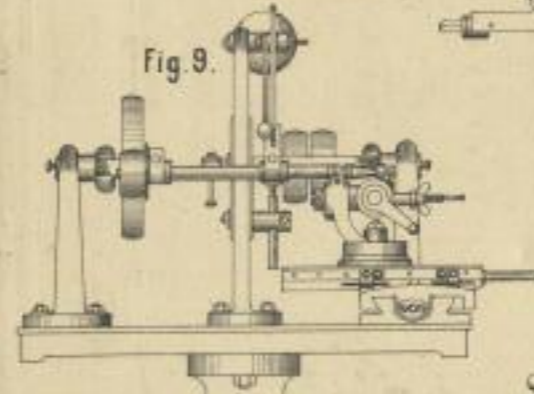

Fig. 9.



Fig. 13.

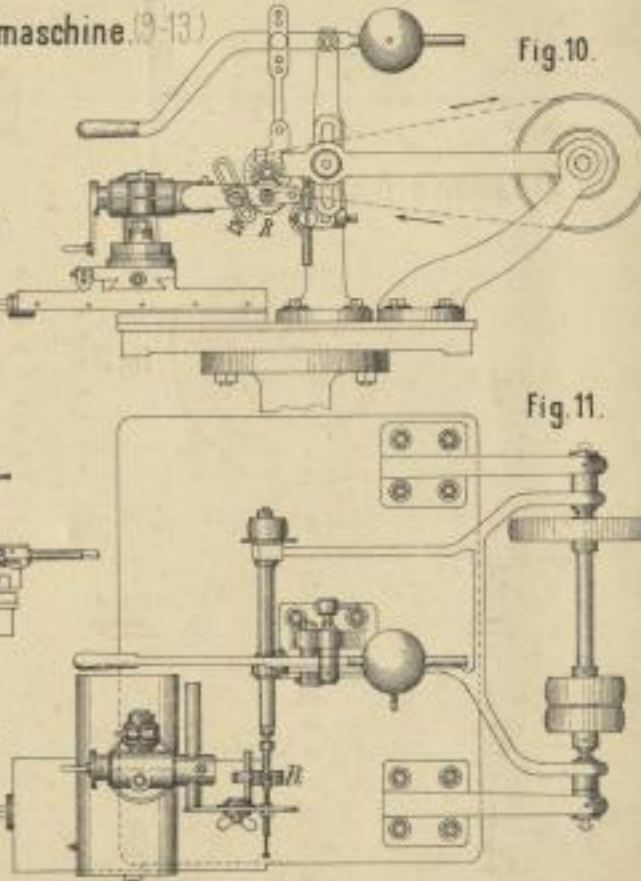

Fig. 10.

Fig. 11.

Entel's Schlagfeder für me- chanische Webstühle (17-19)

Lith. Ansc. F. Wirtz, Darmstadt.







Fein's Anschlagwerk für Thurmuhren. (13 u. 14)

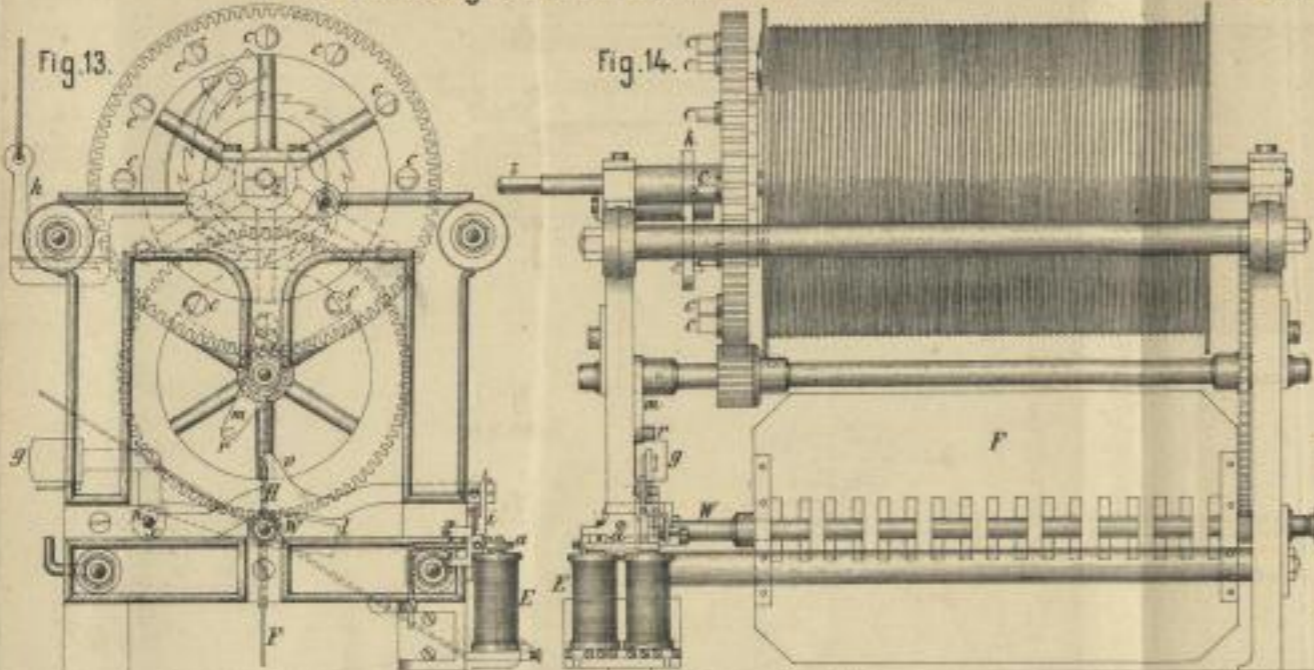

Gardner und Jarvis' Furnürpresse. (2)

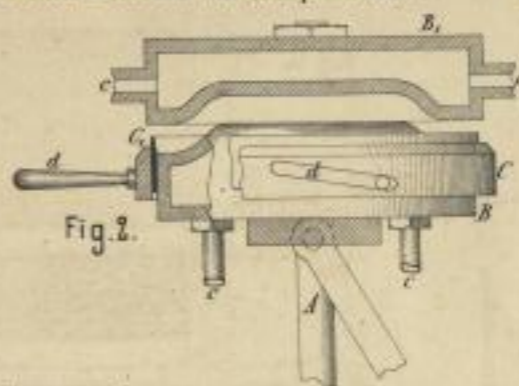

Scheven's Rohranschluss. (1)

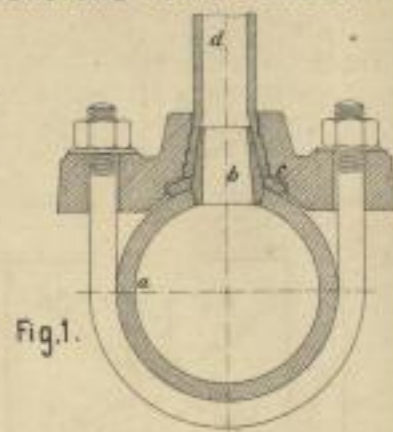

Schnitt III.



Fig. 8.

Fig. 7.

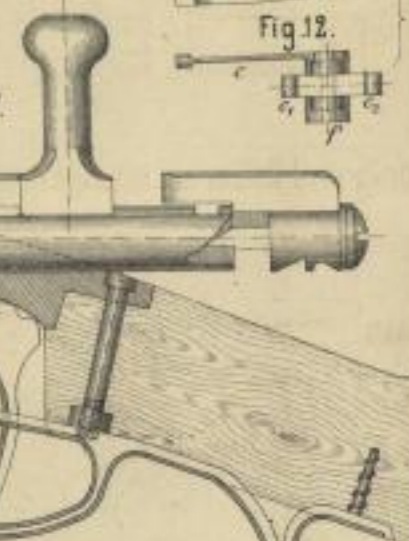
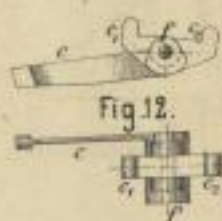
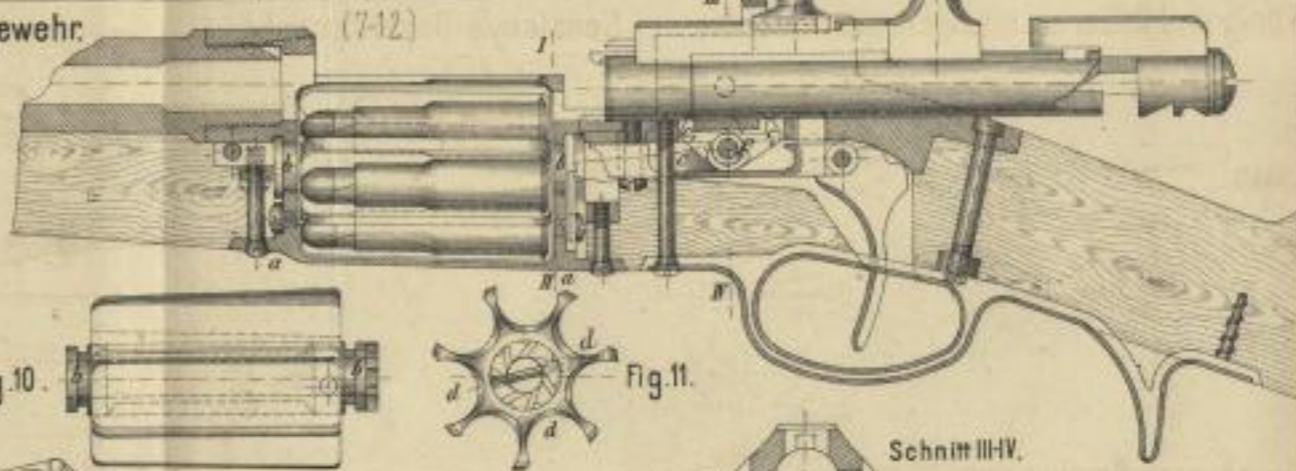
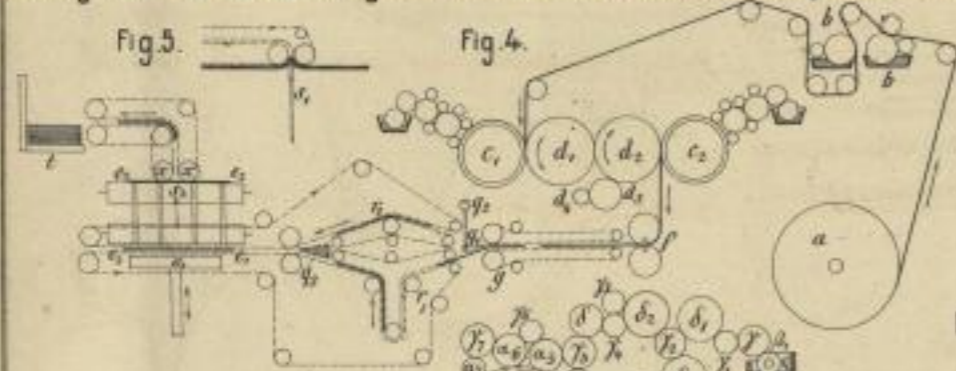

Fig. 12.



König und Bauer's Zeitungsdruckmaschine. (4-6) Spitalsky's Repetirgewehr. (7-12)



Augsburger Rotationsmaschine für Illustrationsdruck. (3)

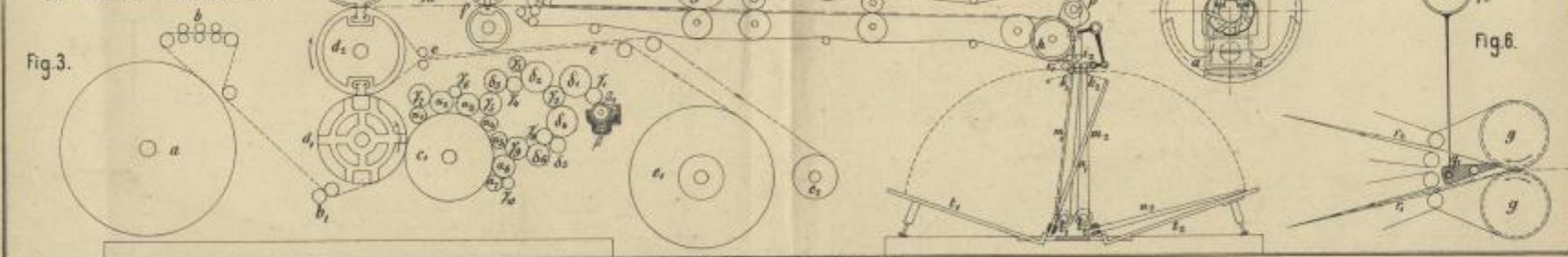

Lith. Anst. v. F. Witz Darmstadt.





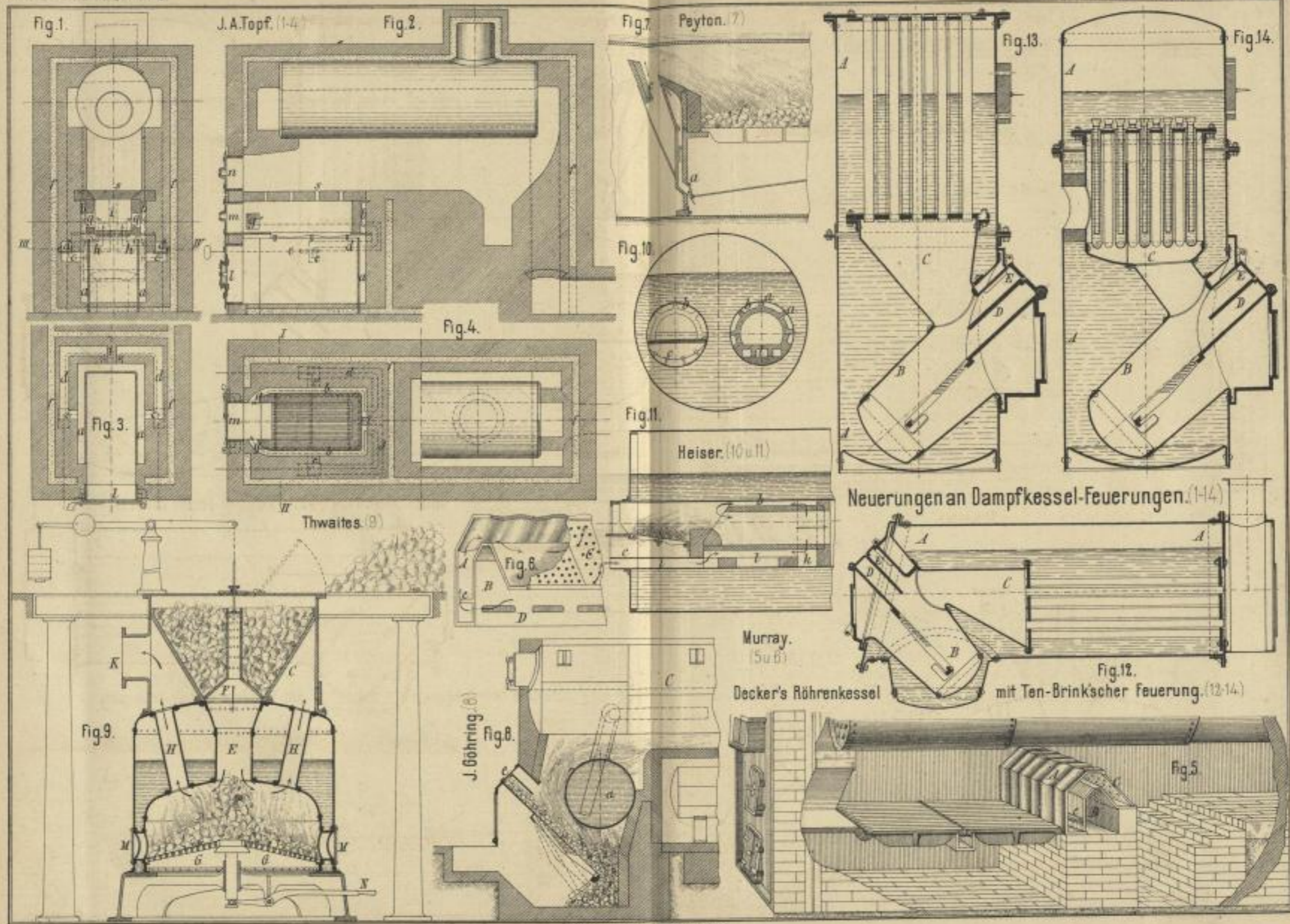

Lith. Anst. v. F. W. v. Dornstadt.



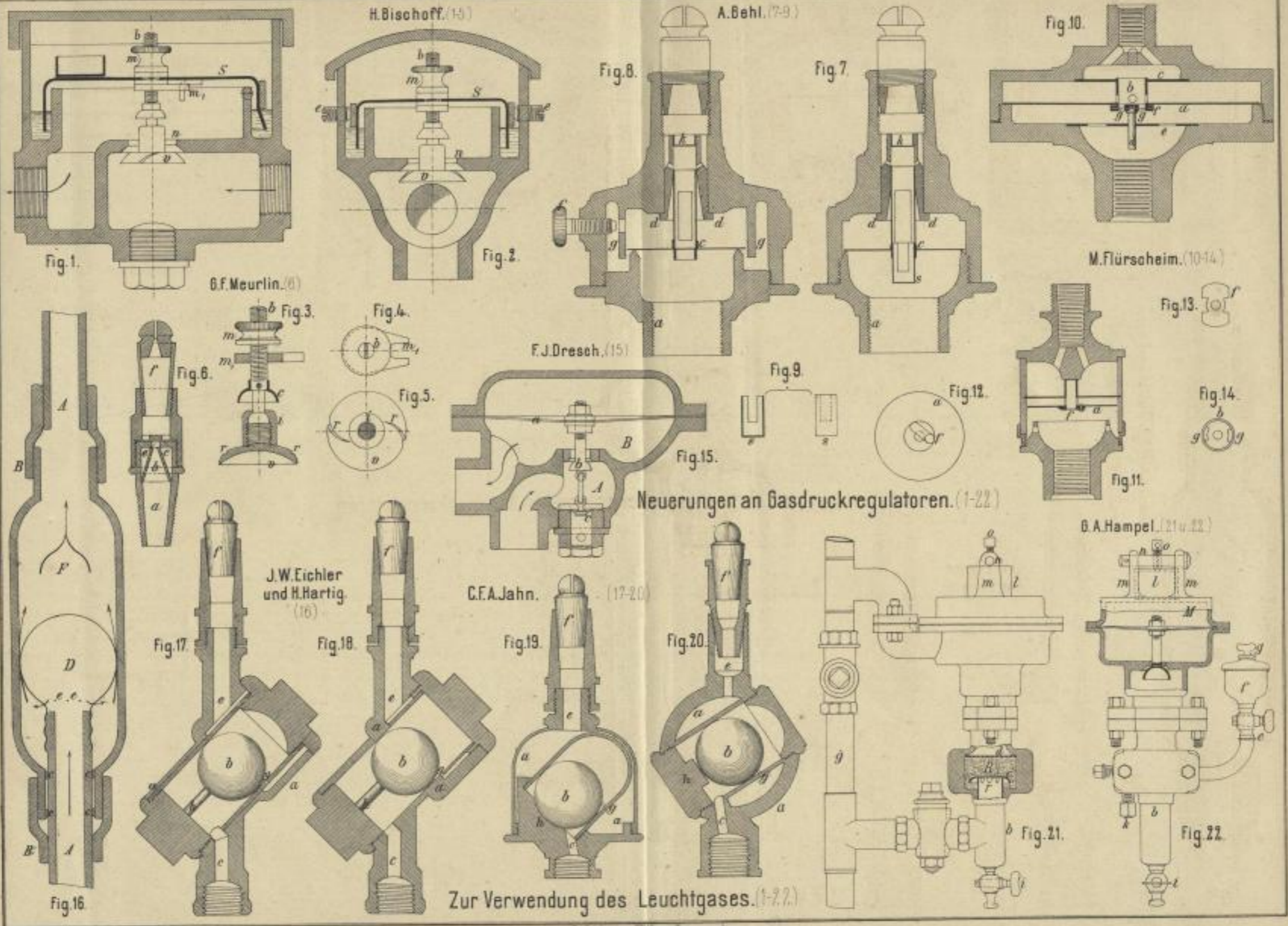

Lith. Anst. v. Ehrlich Darmstadt



Pfaundler's Bestimmung der Eigenwärme. (3)

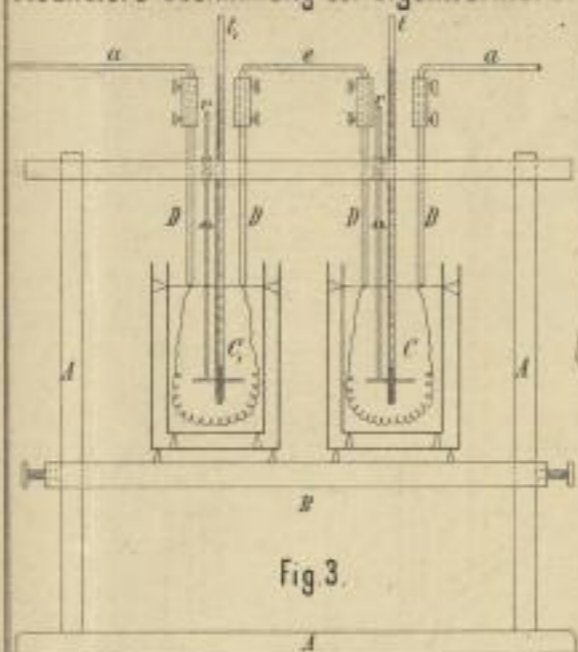

Fig. 3.

Bestimmung von Stickstoff. (11-13)

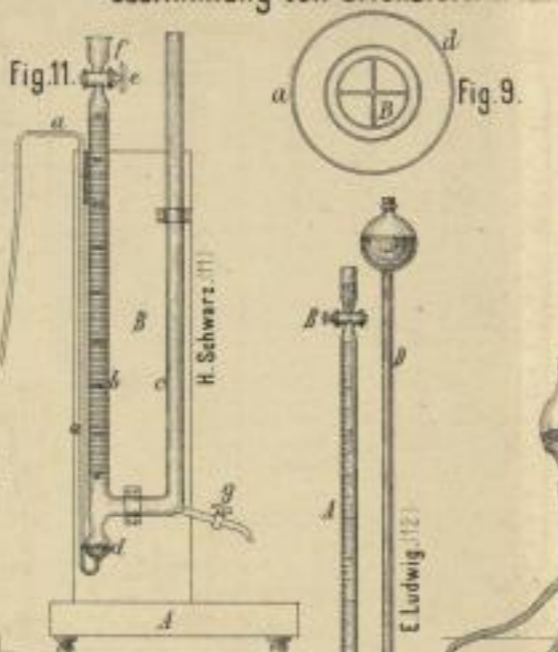

Fig. 9.

Jungfleisch's Apparat für Acetylen. (8-10.)

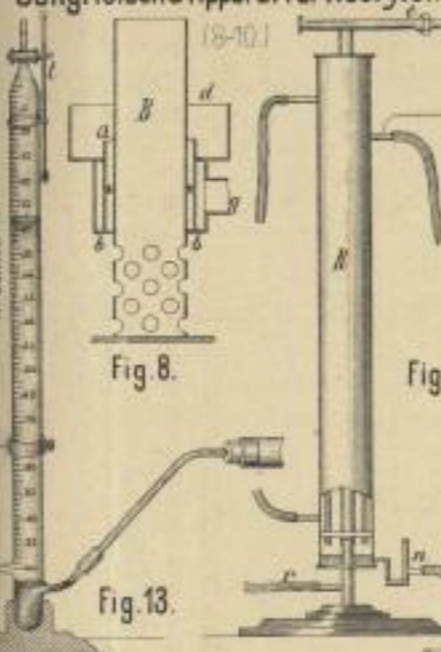

Fig. 8.

Fig. 10.

Fig. 13.

Grüneberg's Destillationsapparat. (6)

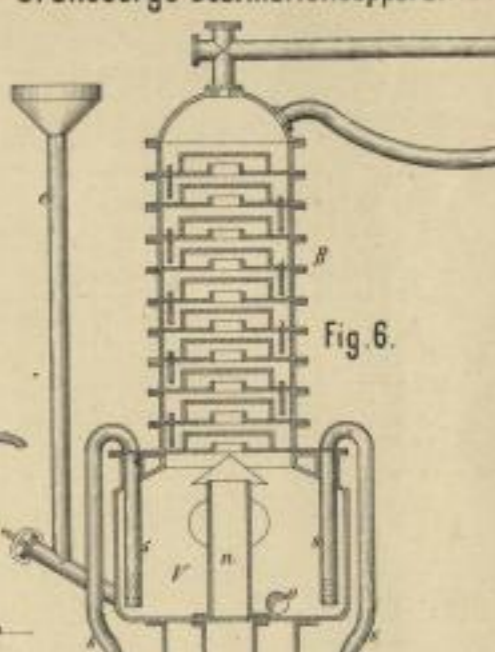

Fig. 6.

Petterson's Bestimmung der Ausdehnung. (2)

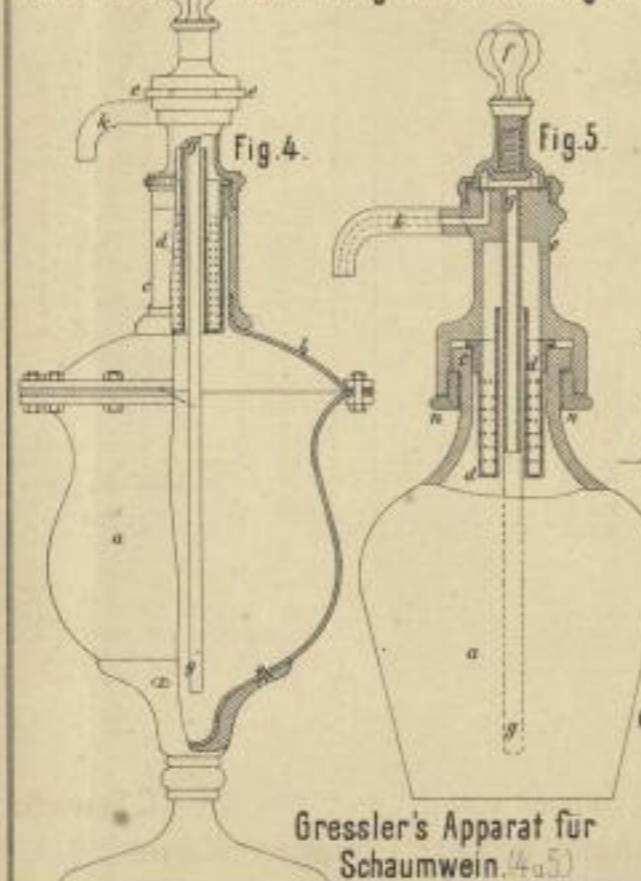

Fig. 4.

Fig. 5.

Gressler's Apparat für Schaumwein. (4a, 5)

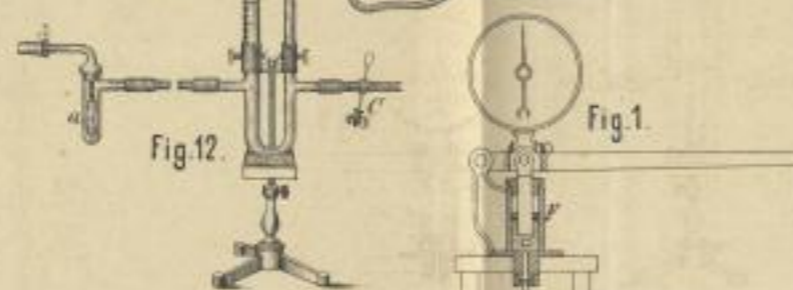

Fig. 12.

Fig. 1.

Fig. 2.

Cozza's Brückenwage. (1)

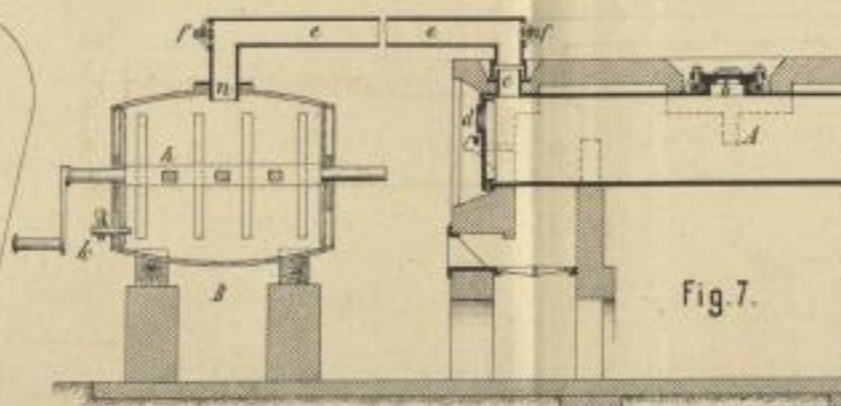
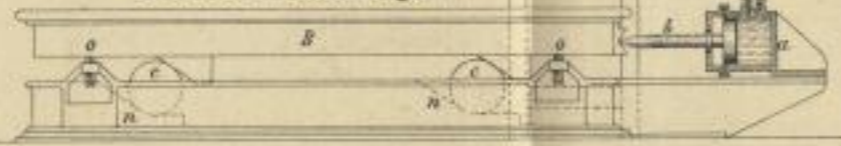

Fig. 7.

Zenisek und C. Schmidt's Apparat für Kieselfluorwasserstoffsäure. (7)

Druck. Anst. v. P. W. Schmidt.





Emil H. Nacke. (3-7)

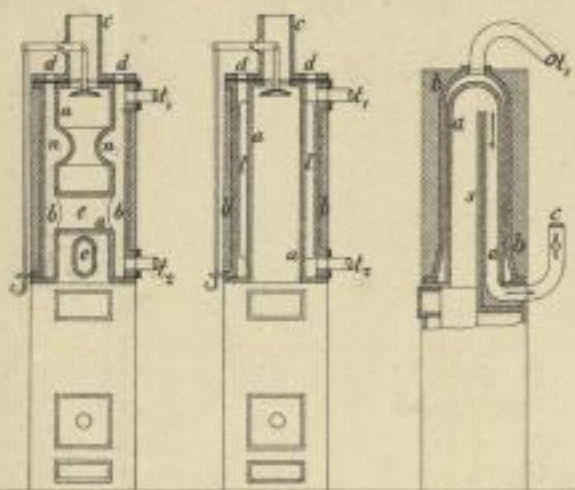

Fig. 3.

Fig. 4.

Fig. 6.

Fig. 5.

Fig. 7.



A. Slaby: Ueber Neuerungen an Luft- und Gasmaschinen.

Leonhard Hopmann.

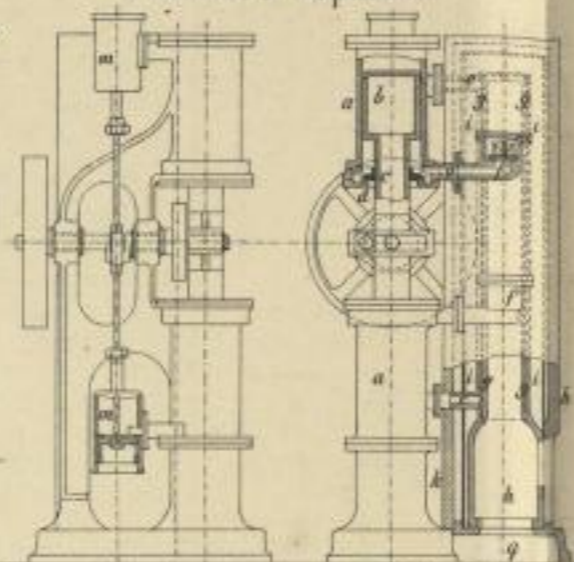

Fig. 1.

Fig. 2.

Martin Hanner. (8 u. 9)

Fig. 8.

Fig. 9.

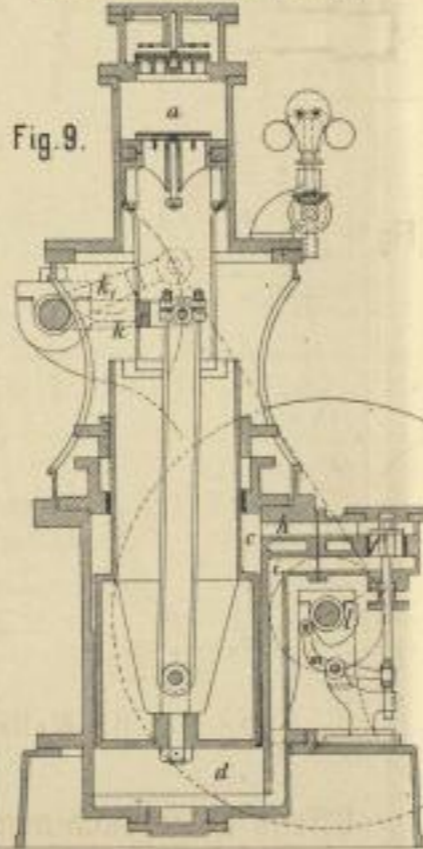
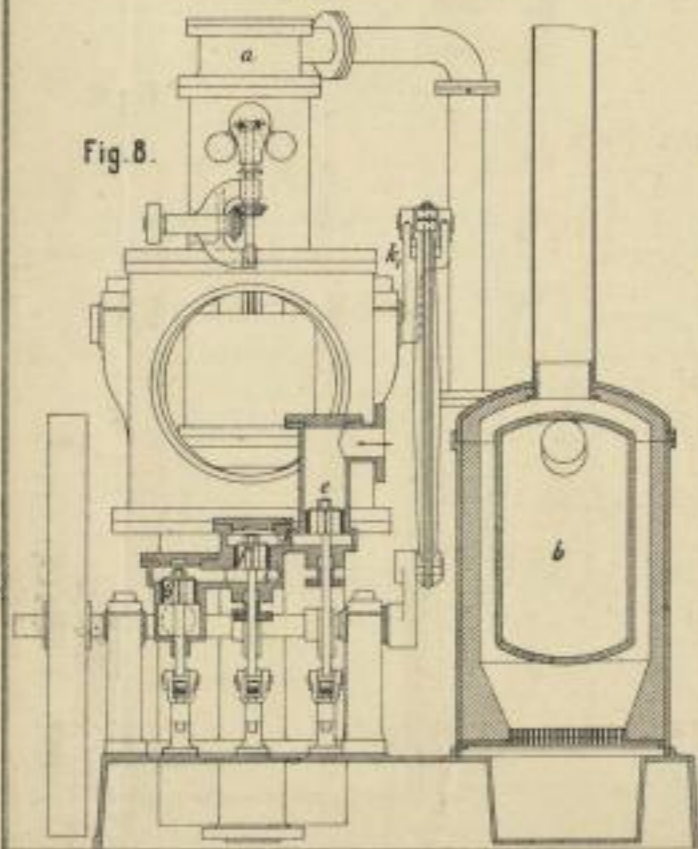

Fig. 10.

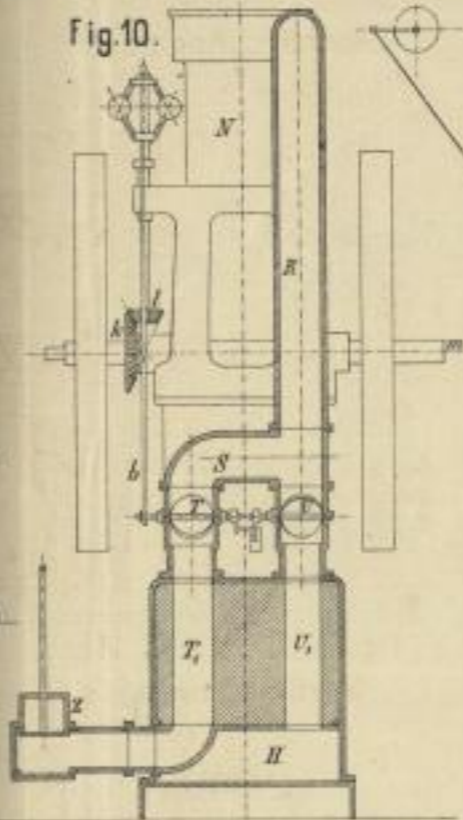

Fig. 13.

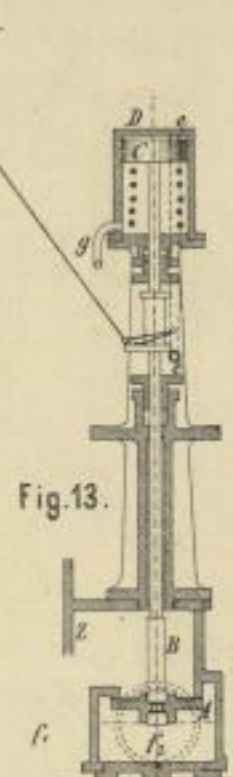

Fig. 11.

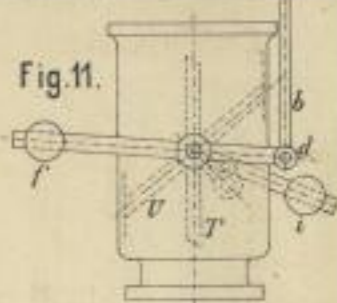

Fig. 12.

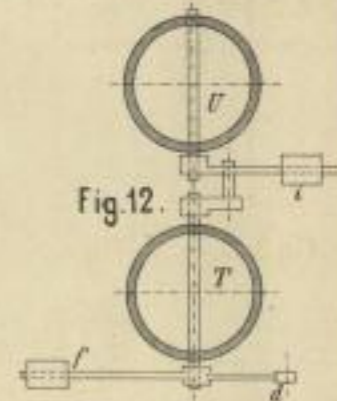
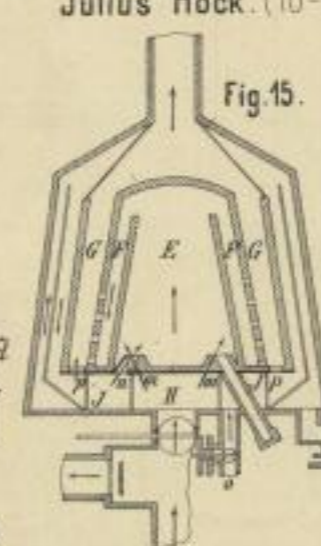
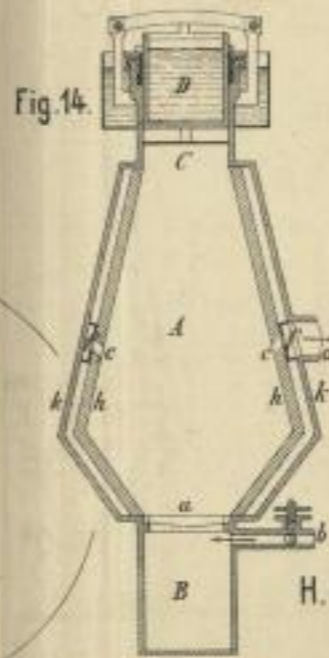

Fig. 16.

Julius Hock. (10-13)

Fig. 14.

Fig. 15.



H. F. Wallmann. (14-16)

Offene Luftmaschinen. (1-16)

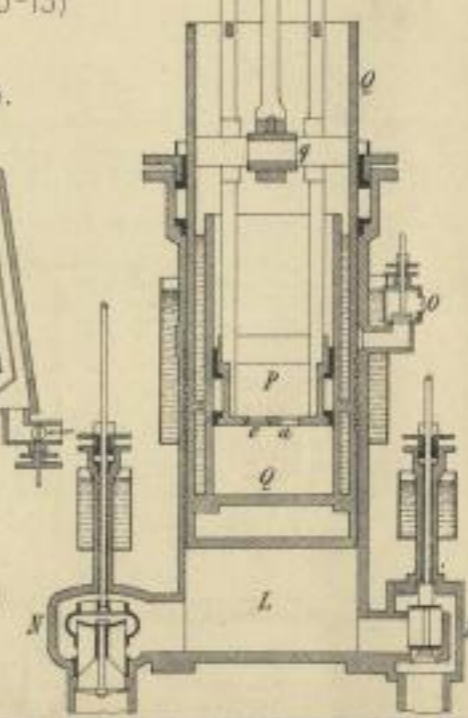

Verf. des Aut. v. F. M. v. Darmstadt





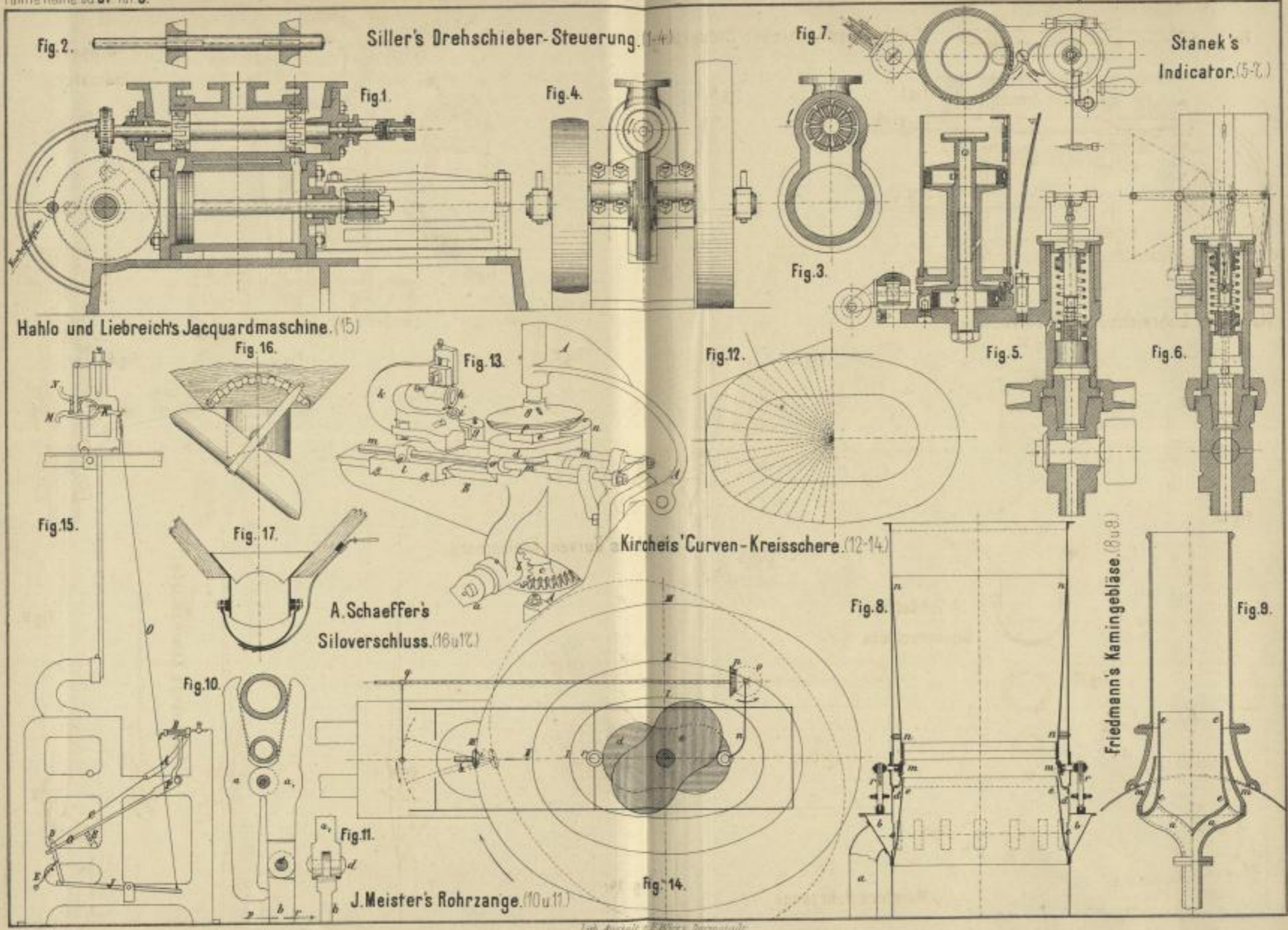

Lab. Anstalt E. W. v. Dornmühle.



G. Schaeffer's Schneidscheiben. (6 u. 7)

Kick: Neuerungen im Mühlenwesen. (1-22)

Nagel und Kaemp's Walzenstuhl bezieh. Desintegrator. (16 bez. 17)

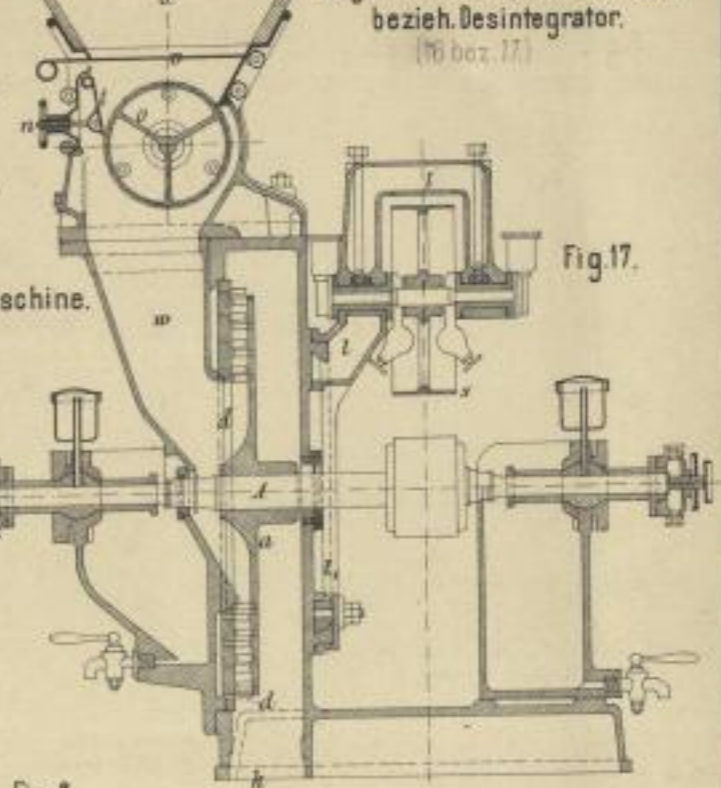
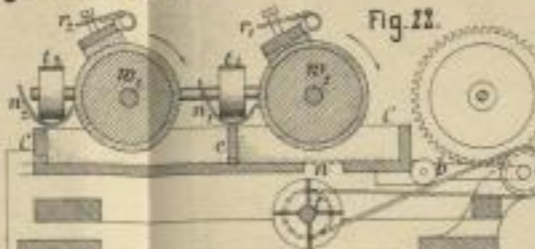
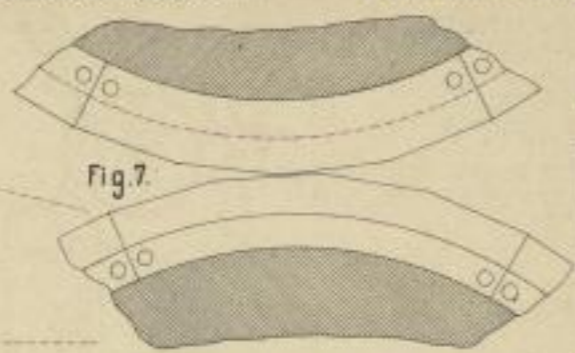
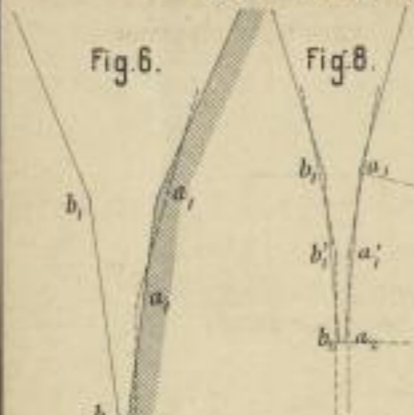

Buchholz's Riffelung. (10 u. 11)

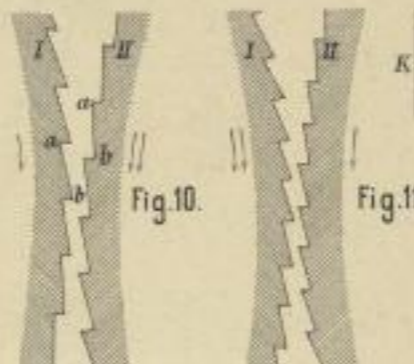
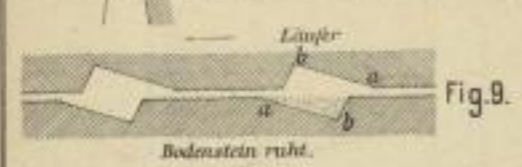

Smith und Osborne's Griesputzmaschine. (22)

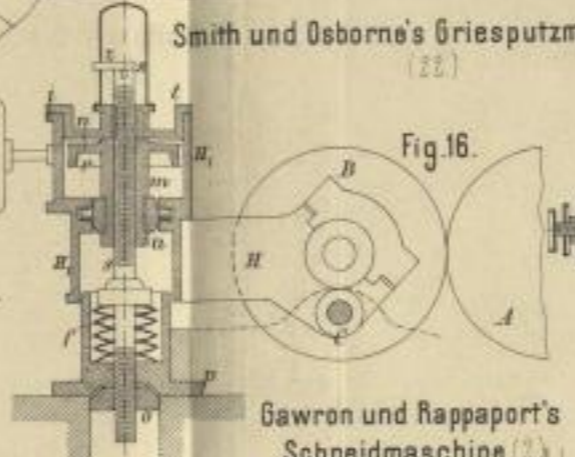

Zum Flachmahlen bewegt sich 8 schrägler / Zum Schroten bewegt sich 1 schrägler

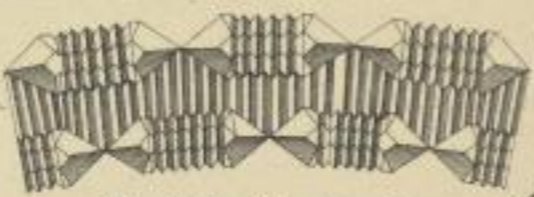

Zu Fr. Schmid's Mahlgang. (21)

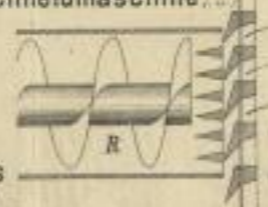

Gawron und Rappaport's Schneidmaschine. (2)

Fig. 2.

Nemeika's Walzenstuhl. (14 u. 15)



Millot's Zahnscheibe. (3 u. 4)

Ritschler's Schrotgang. (5)



Fig. 5.

Fig. 21.

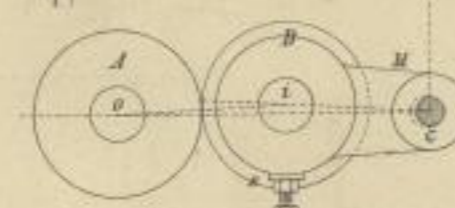

Fig. 15.

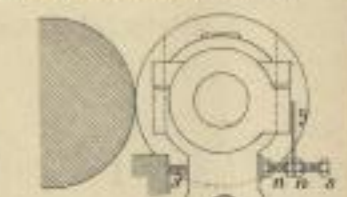
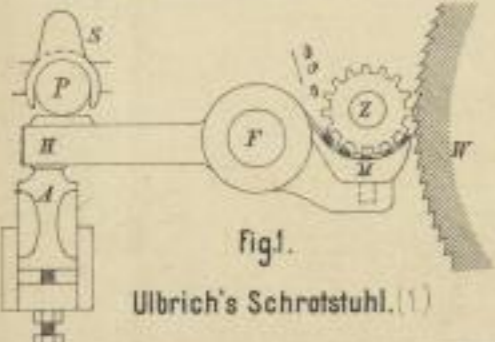

Fig. 14.

A. Braun's Walzenstuhl. (12 u. 13)



Ulbrich's Schrotstuhl. (1)

Weber und Bünzli sowie Daverio's Scheibendetacheur (18-20)

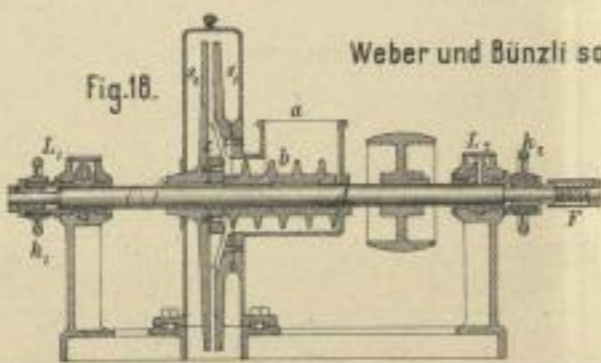

Fig. 18.

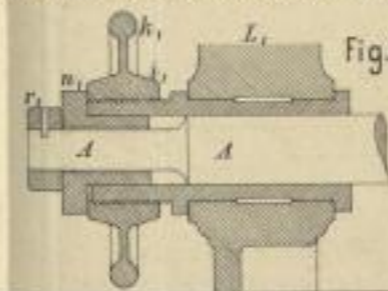

Fig. 19.

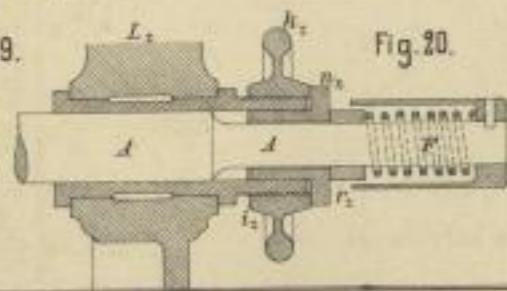
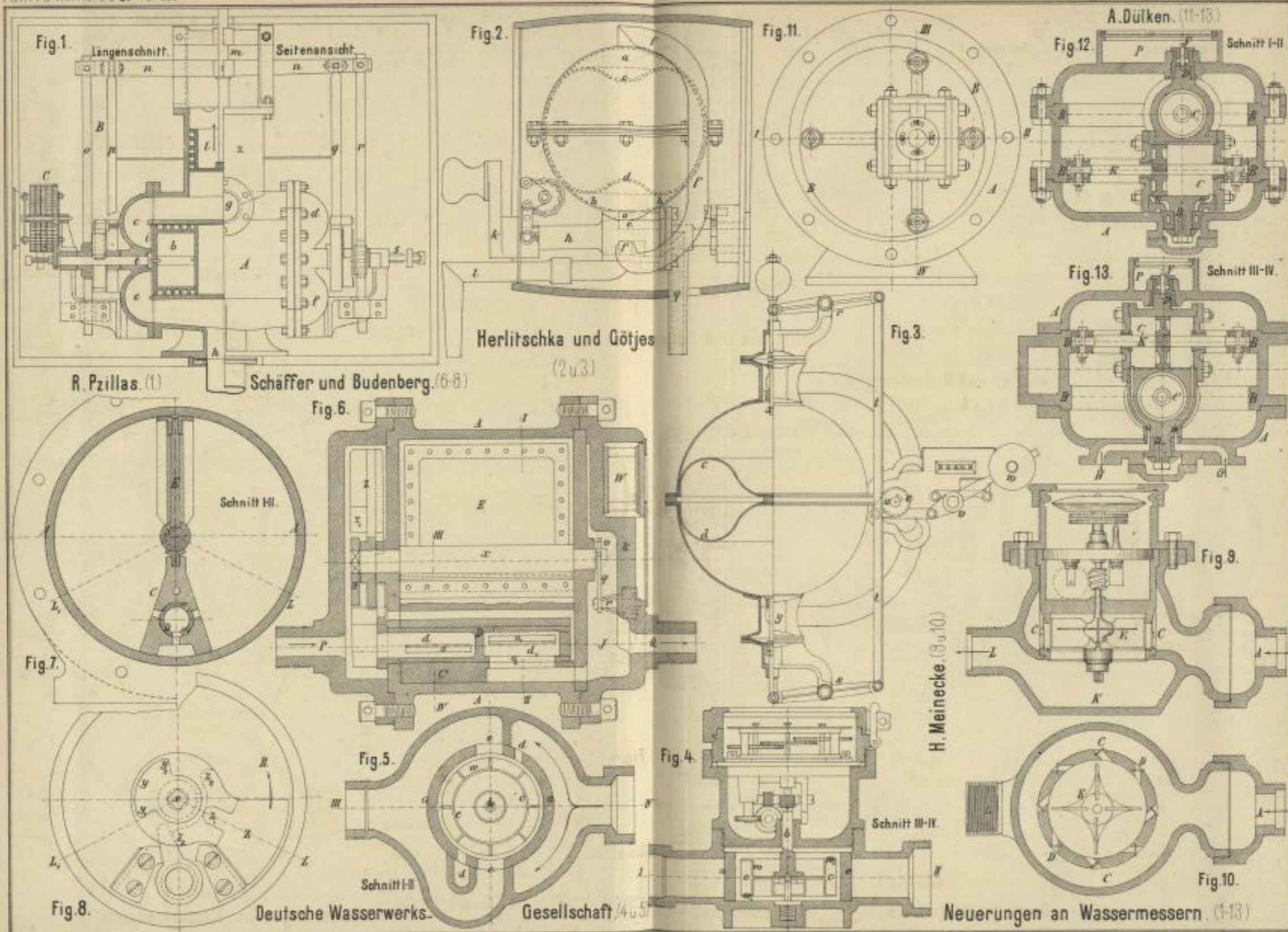

Fig. 20.

Zeich. Anst. v. F. Metz, Darmstadt







Lith. Anst. v. W. v. Hartmann, Darmstadt.



Francotte's Gewehr. (1)

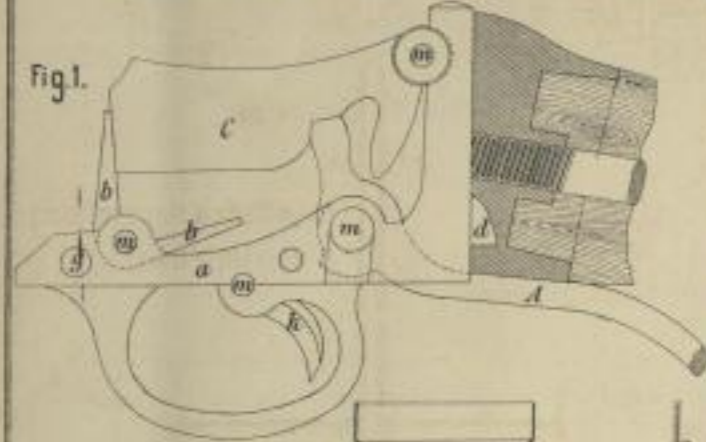

Herstellung von Blausäure aus Trimethylamin. (13)

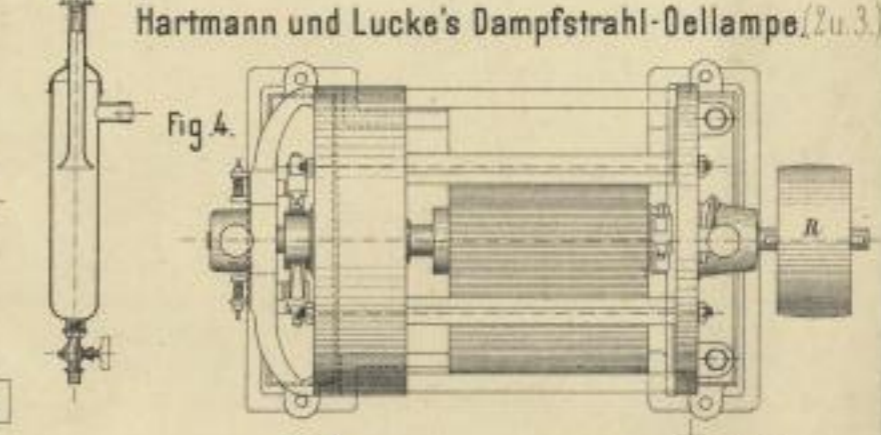
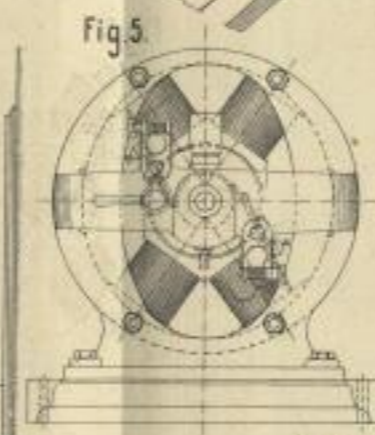
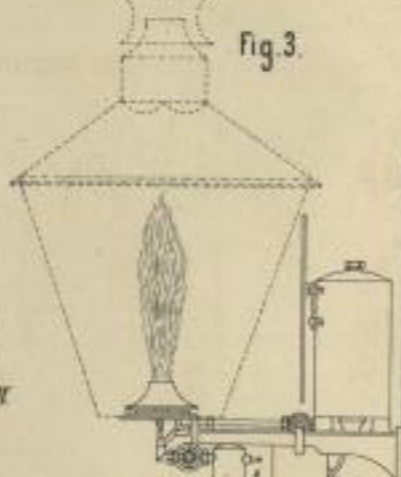
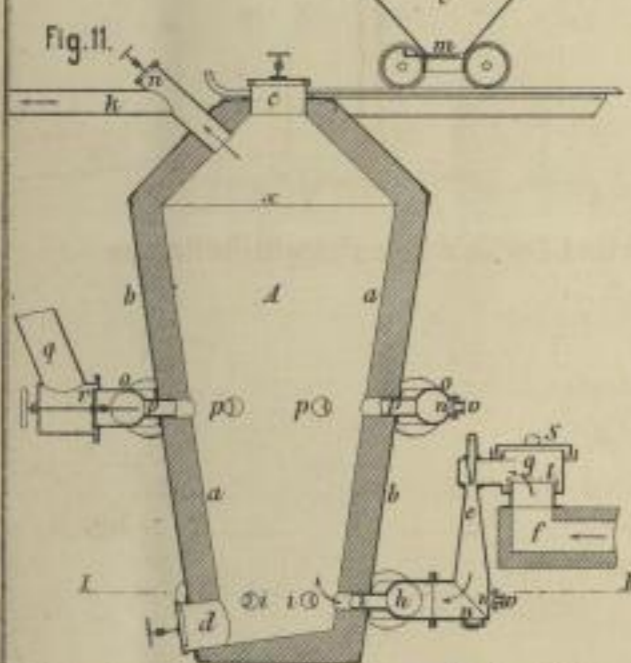
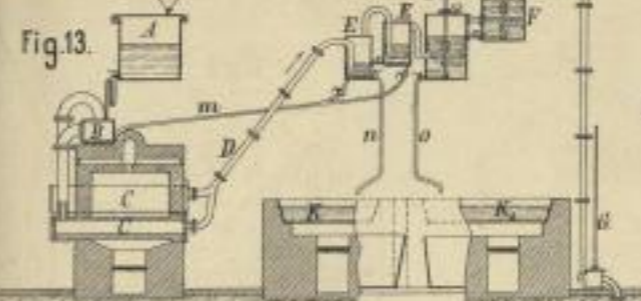
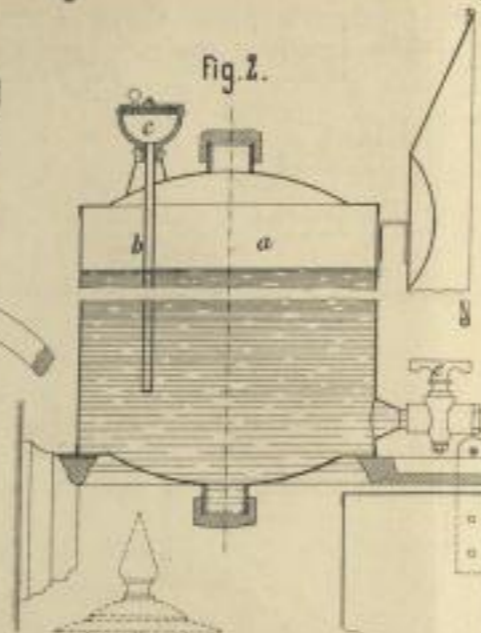

W. Hartmann's Darstellung von Schwefelwasserstoff. (11 u. 12)

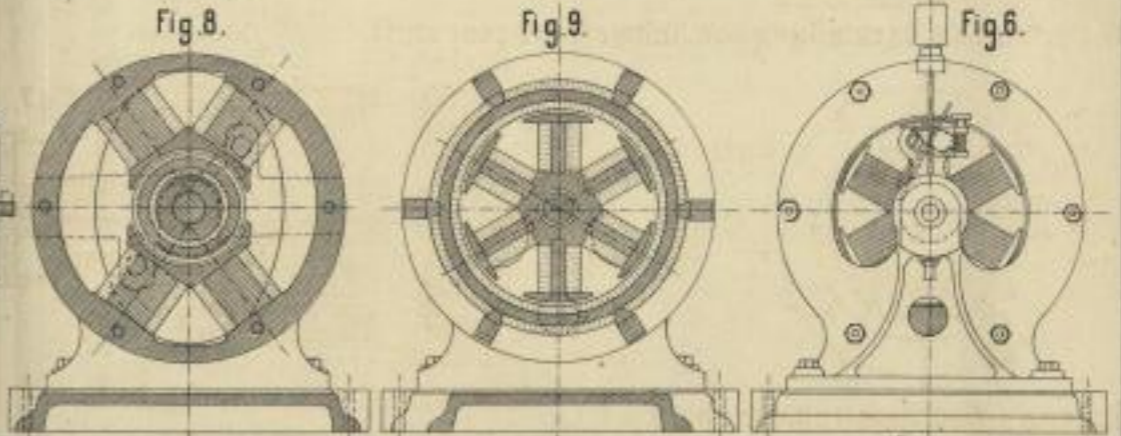
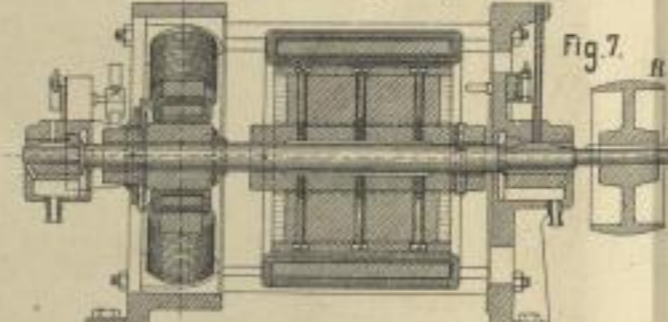
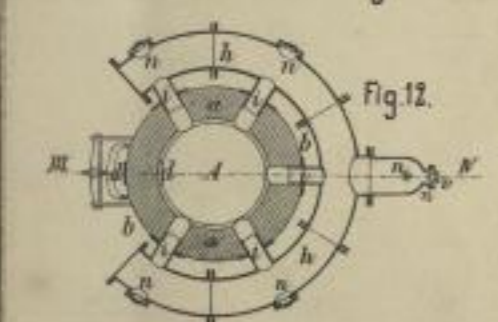

Gramme's Wechselstrommaschine. (4-9)

Verf. Anst. F. Wirtz, Darmstadt.



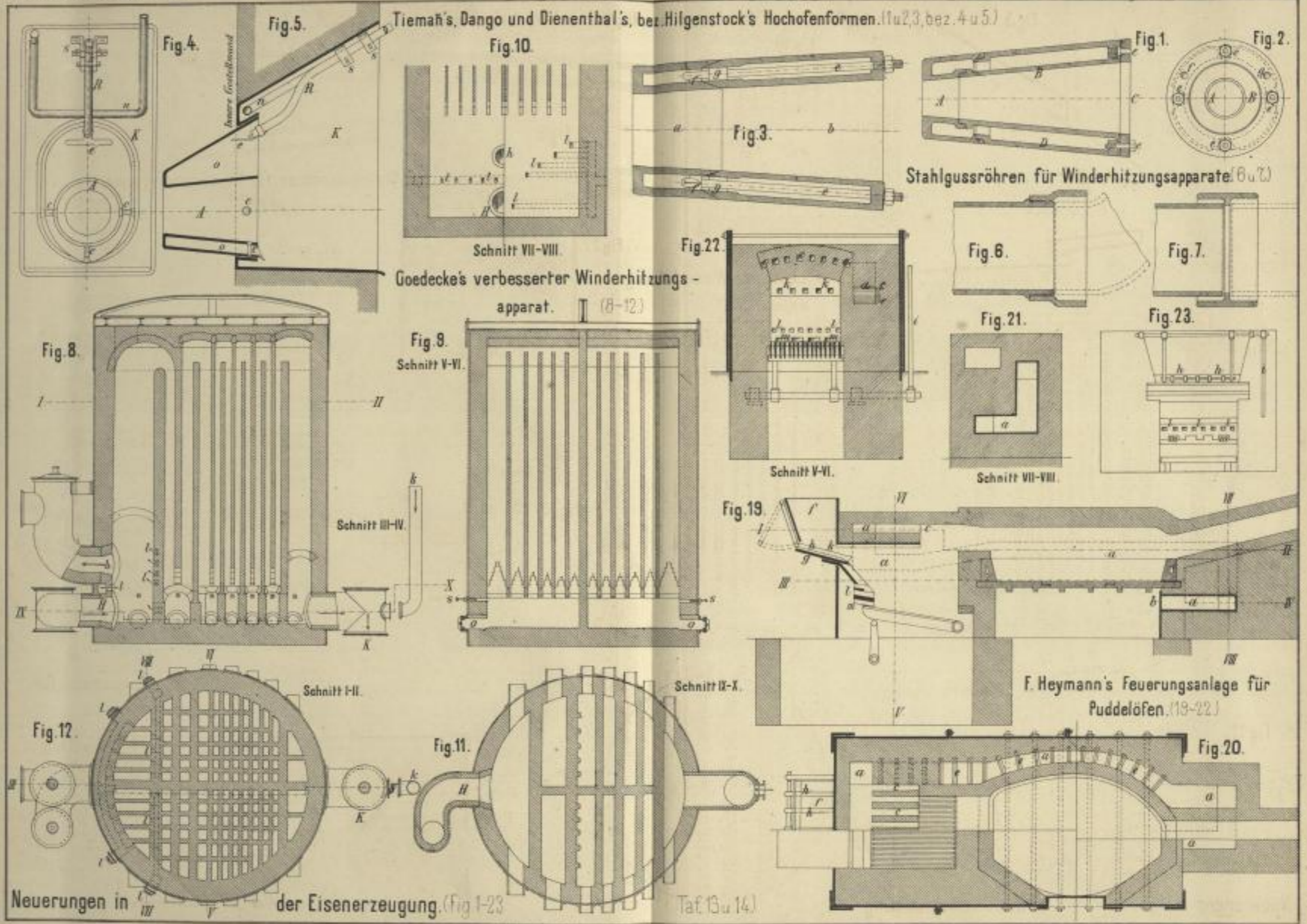

Lith. Anst. v. F. W. Meyer, Dresden.



Beilstein und Jawein's Werthbestimmung von Zink und Zinkstaub. (3)

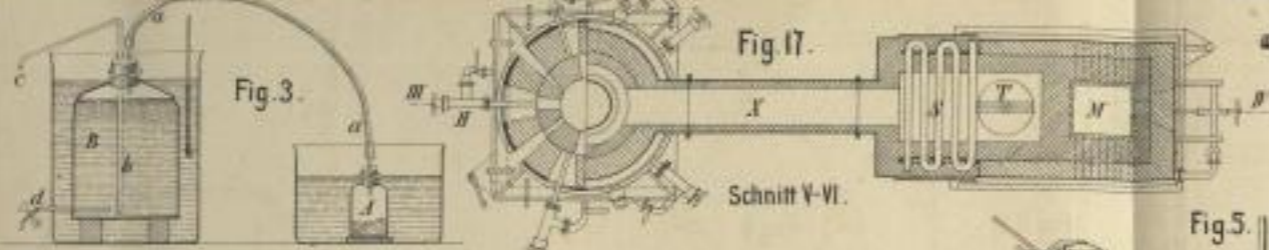

Kücken's zerlegbares Drahtgitter (5 u. 6) Pfaundler's Luftthermometer. (4)

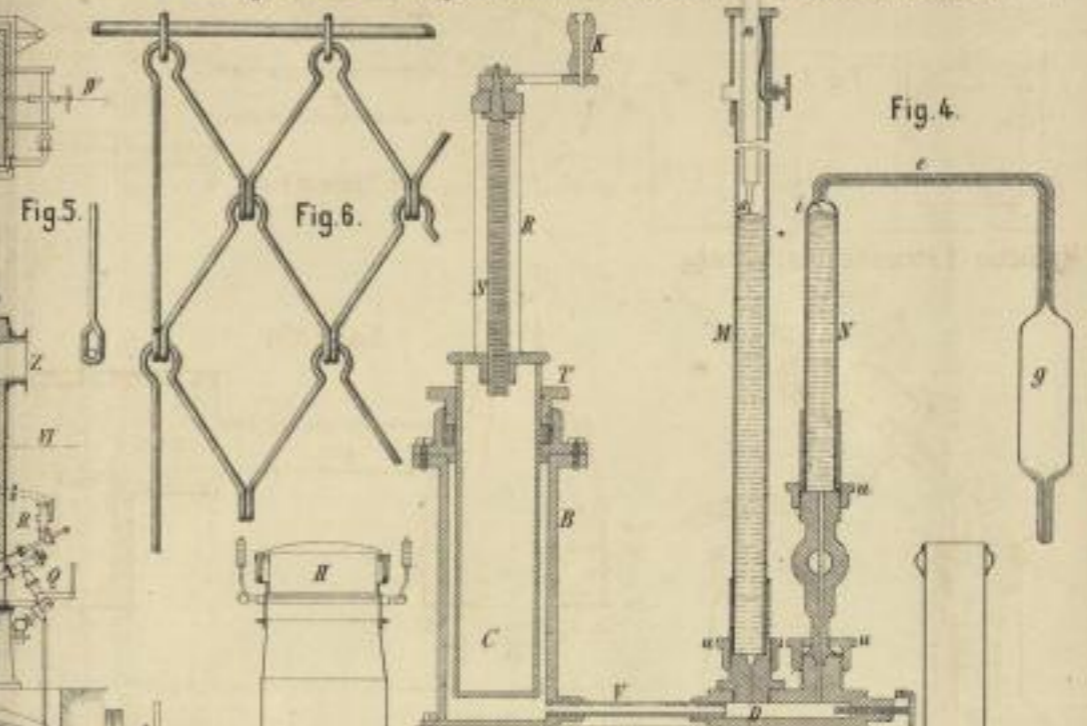

Medicus' Extractionsapparat. (1 u. 2)

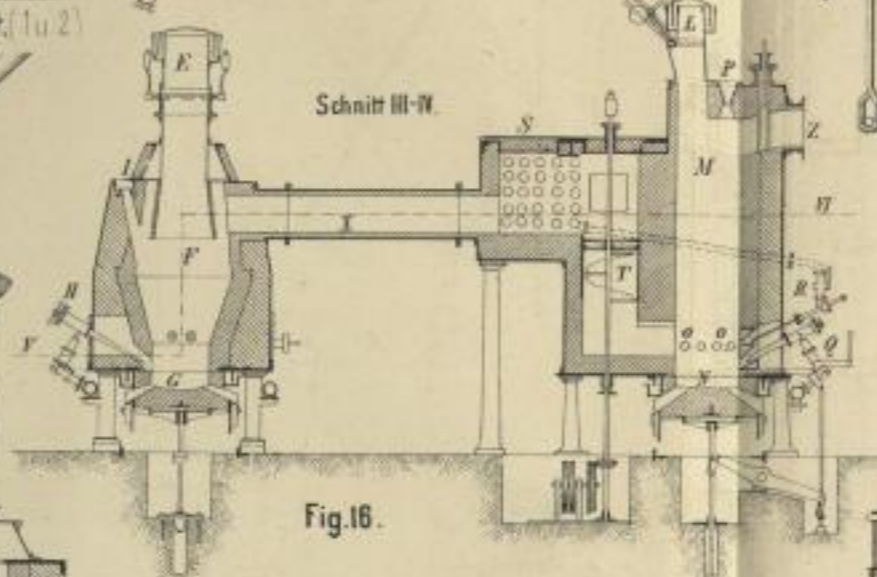

Neuerungen in der Eisenerzeugung (Fig. 1-23 Taf. 13 u. 14)

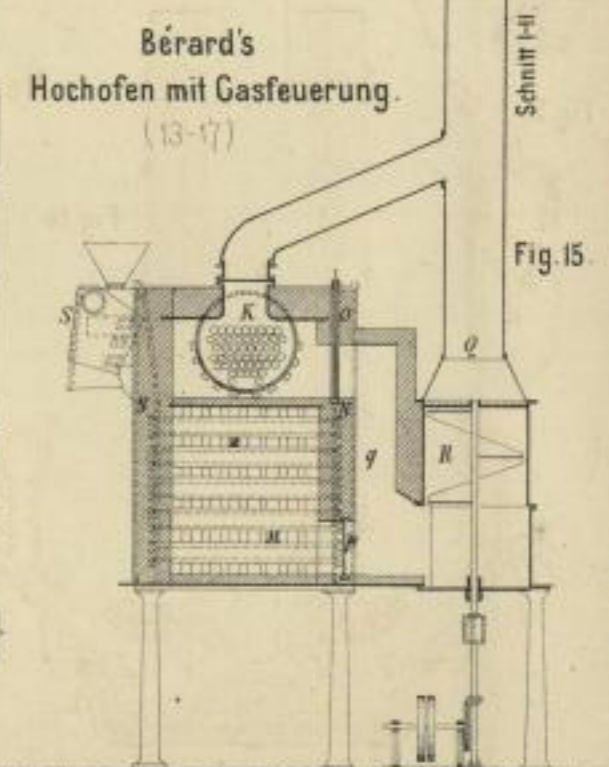
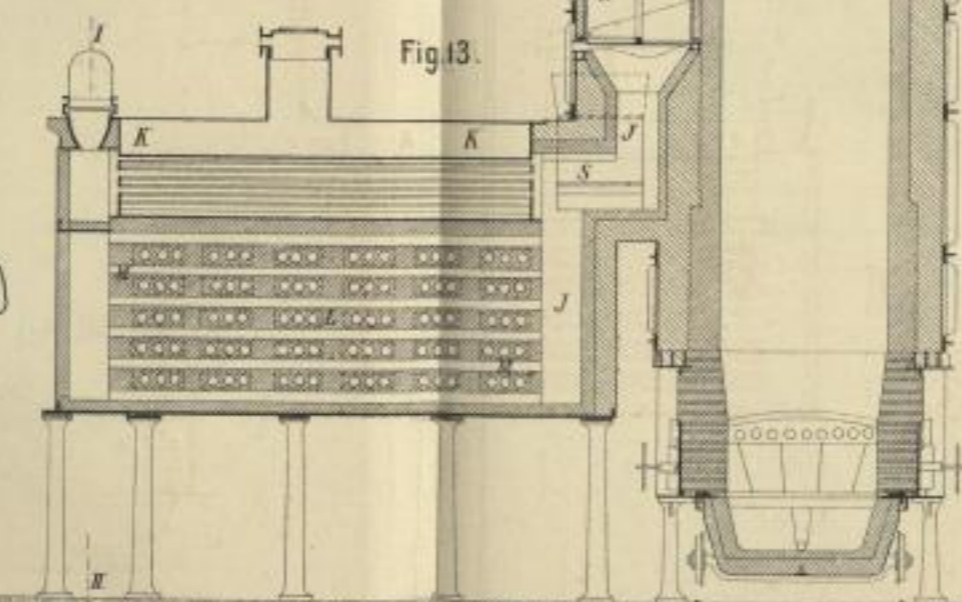
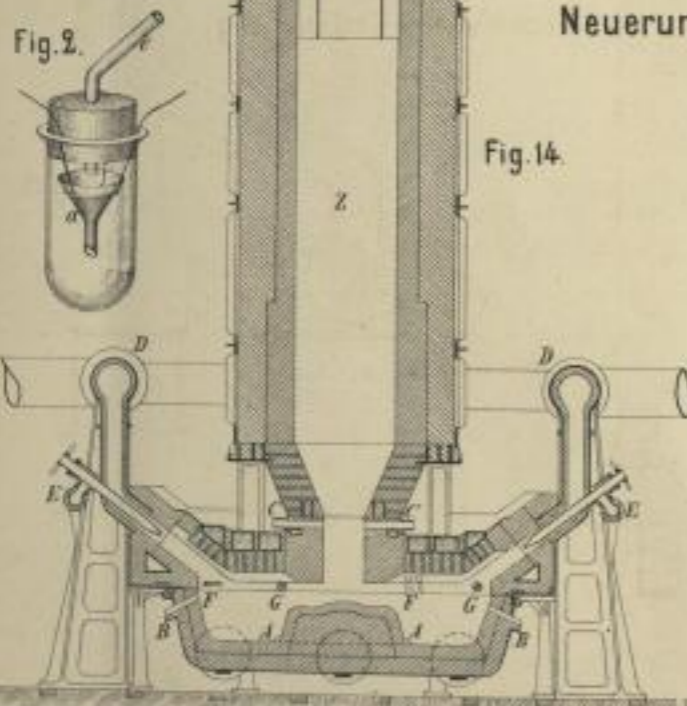

Bérard's Hochofen mit Gasfeuerung. (13-17)

Leit. Anstalt von F. W. G. G. G.



Hallam's doppelwirkende Injectoren. (1-3)

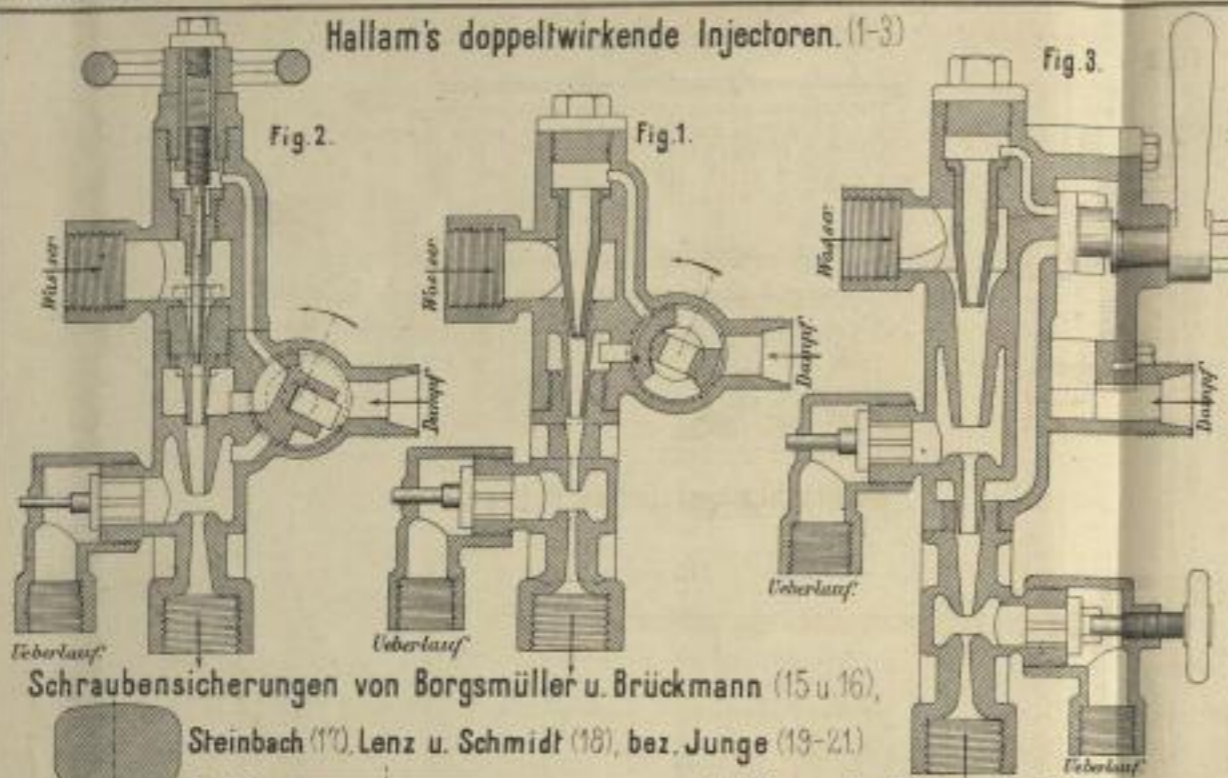

Schwannecke's Hubzähler. (12-14)

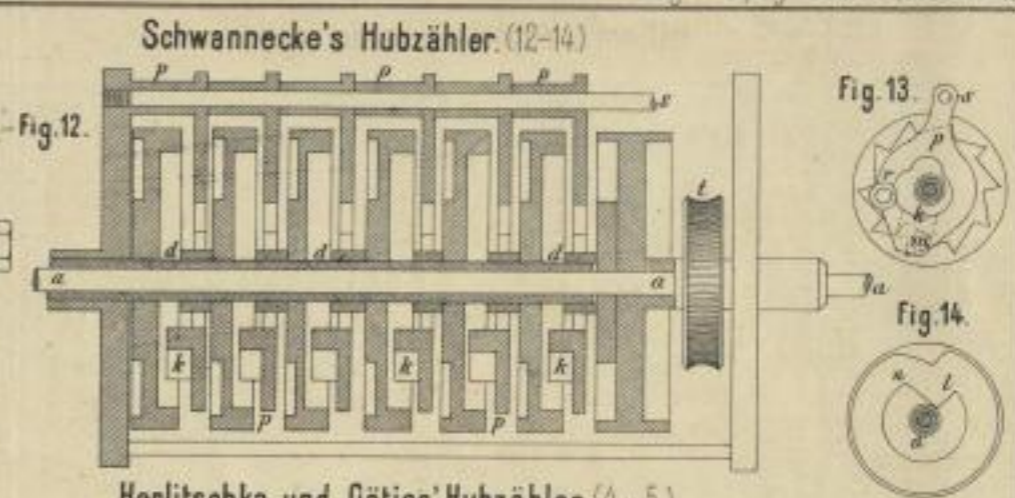

Herlitschka und Götjes' Hubzähler. (4 u 5)

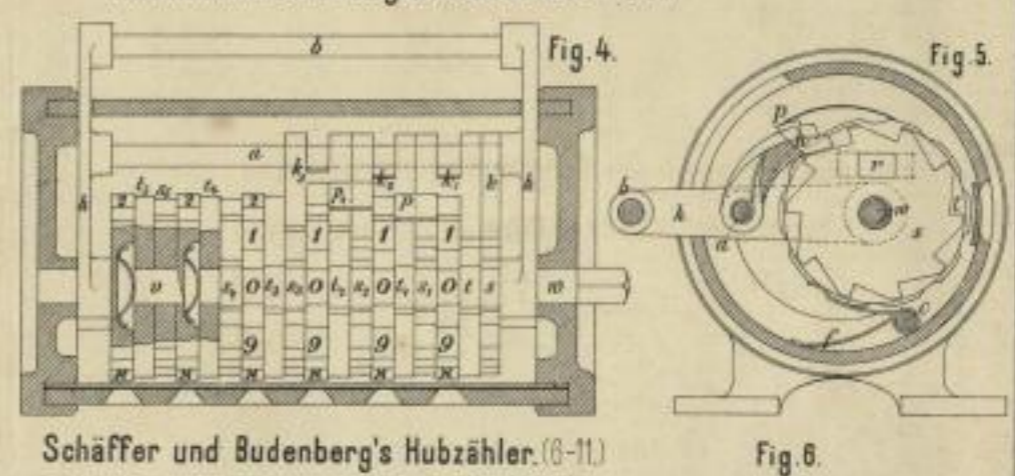

Schraubensicherungen von Borgsmüller u. Brückmann (15 u. 16),

Steinbach (17), Lenz u. Schmidt (18), bez. Junge (19-21)

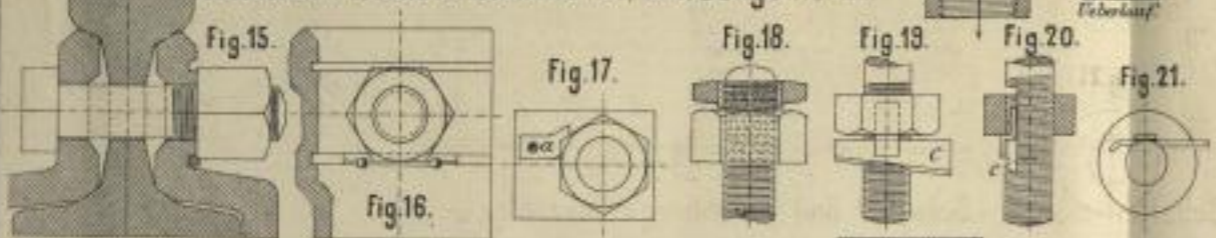

Schäffer und Budenberg's Hubzähler. (6-11)

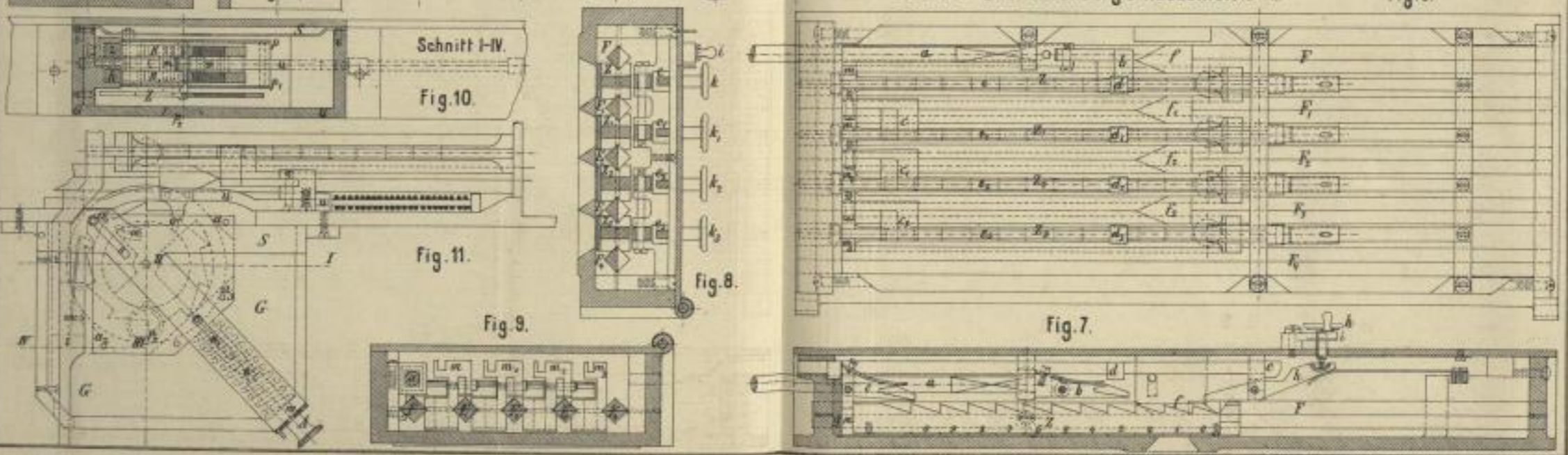

Leit. Anstalt + F. Wenz, Darmstadt.





A. Bachmann's Rollmaschine für conische Rohre (1-8)

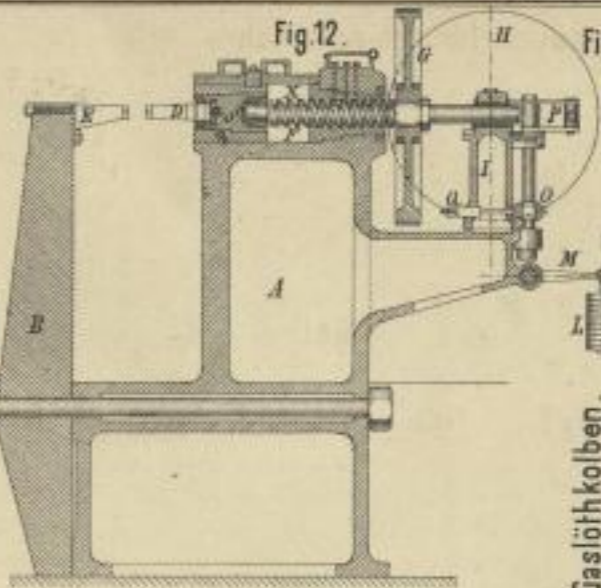
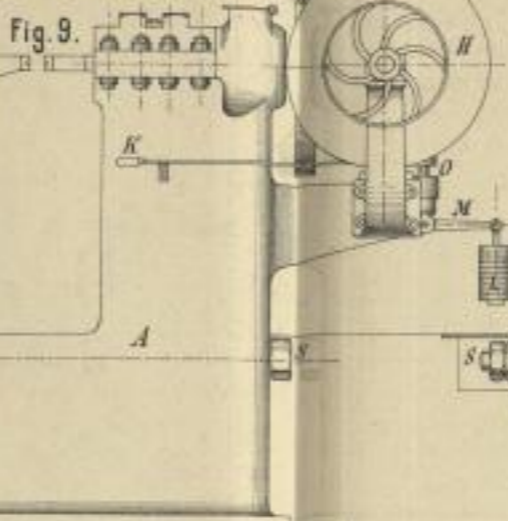
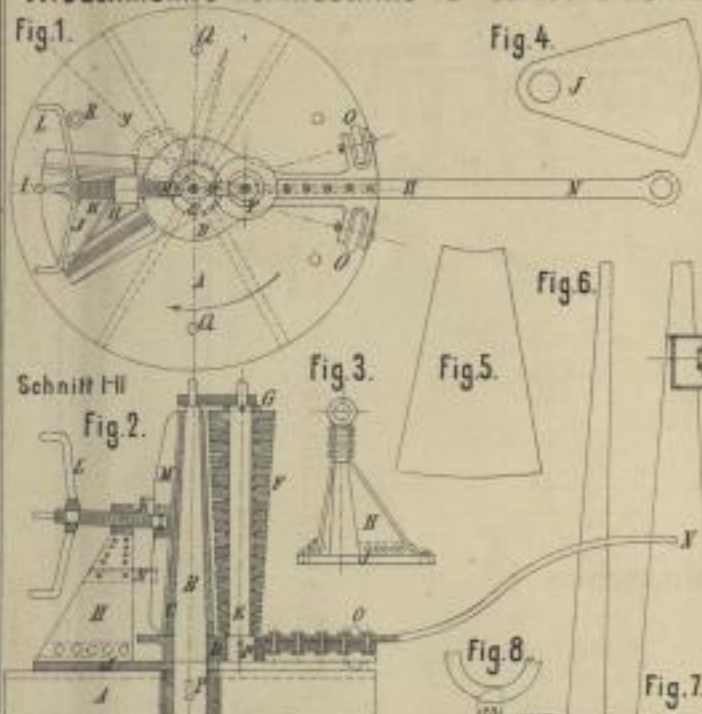

Le Brun's Nietmaschine. (9-12)

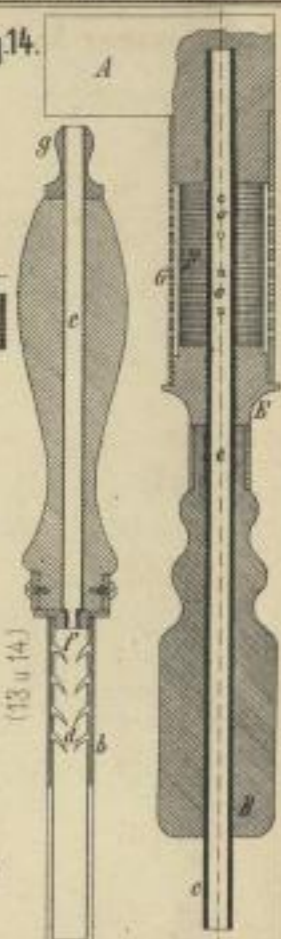

Vängel und Hamilton's Gaslöthkolben. (13 u. 14)

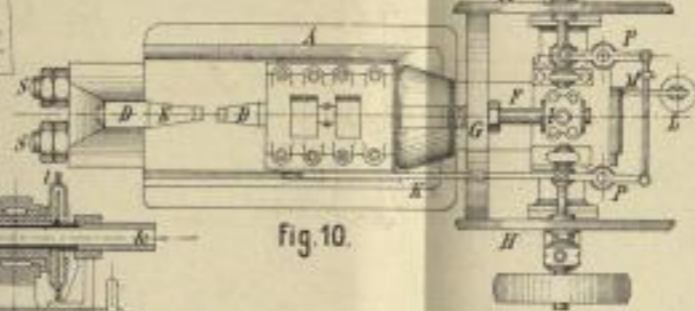

W. Brown's Fass-Hebevorrichtung. (20 u. 21)

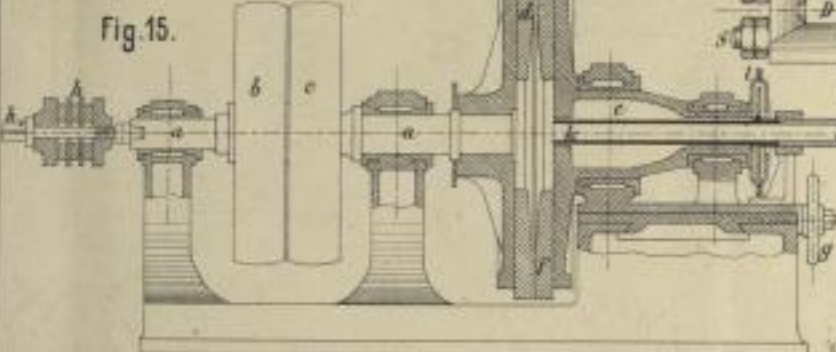
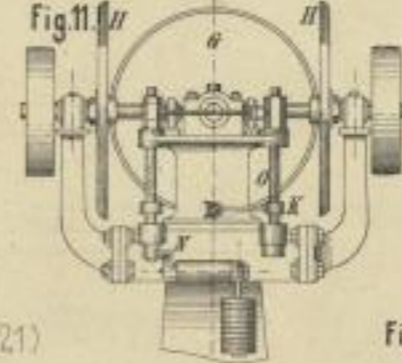

Heberle's Bogardus-Mühle. (15 u. 16)

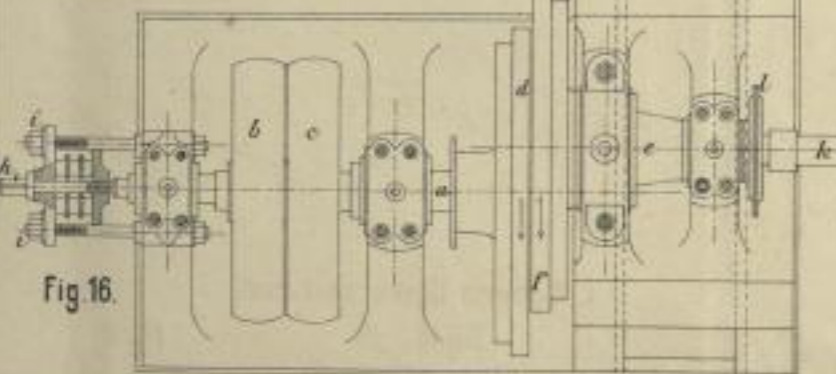
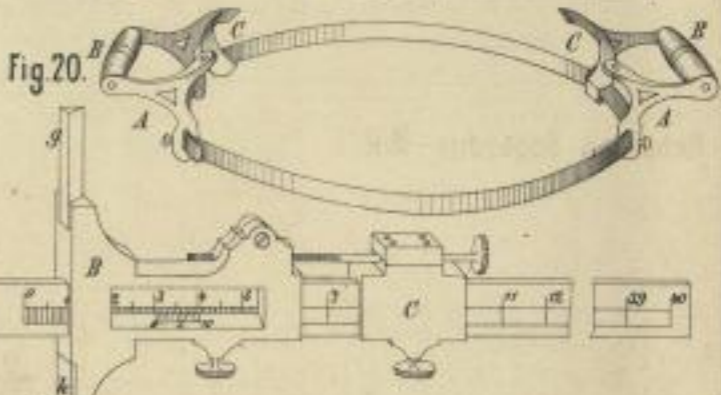

Fig. 21.



L. Weber's Universalzirkel. (17-19)



Fig. 17.



Fig. 18.

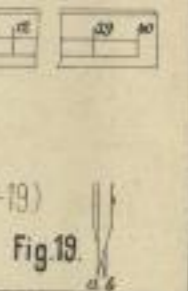

Fig. 19.

Lith. Anst. = E. Witz, Darmstadt.



Haseloff's Schüttelkipprost. (1-7)

F. Schmidt's Treppenrost Beschütter. (11 u. 12)

Dankwarth's Feuerung mit Beschickung von unten. (17-20)

W. J. Hunter's mechanische Feuerung. (21 u. 22)

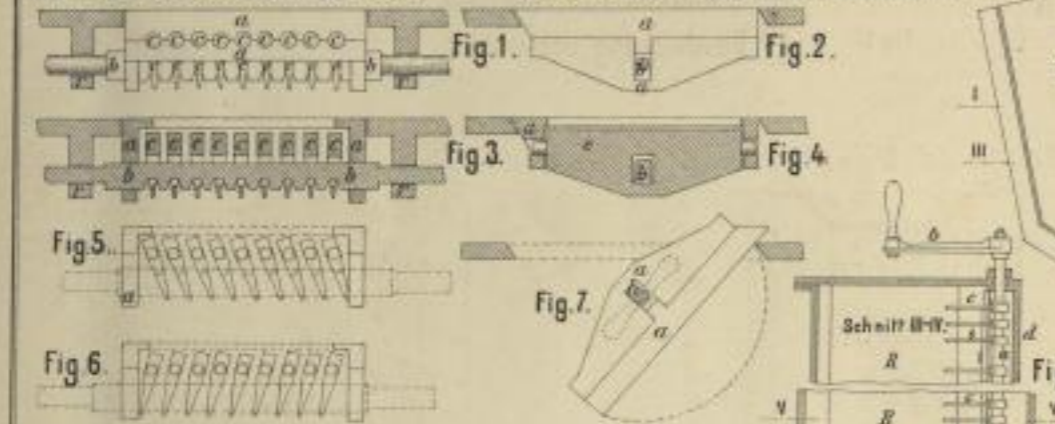

Hopmann's mechanischer Rost. (8 u. 9)

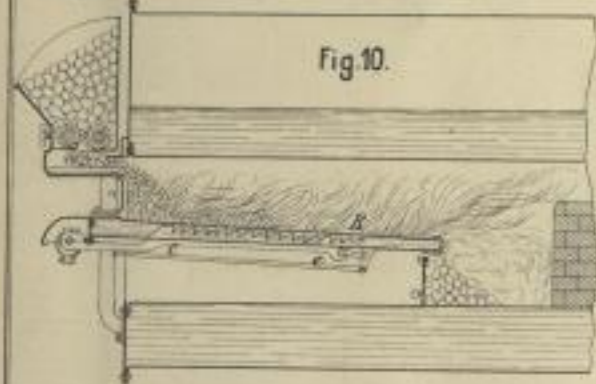

Butterworth's mechanische Feuerung. (10)

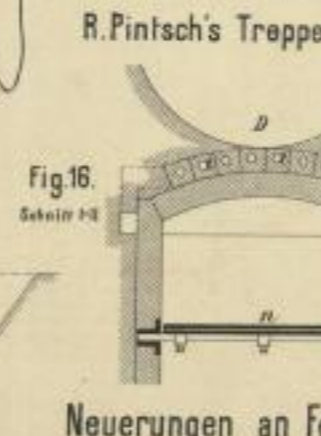
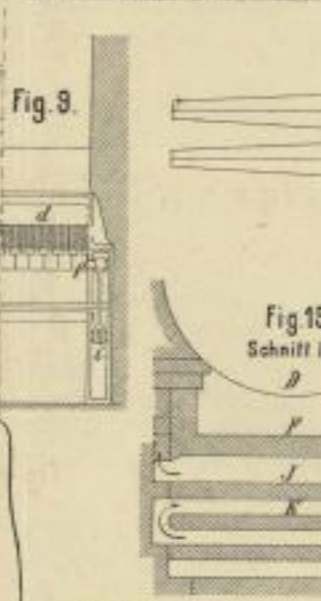
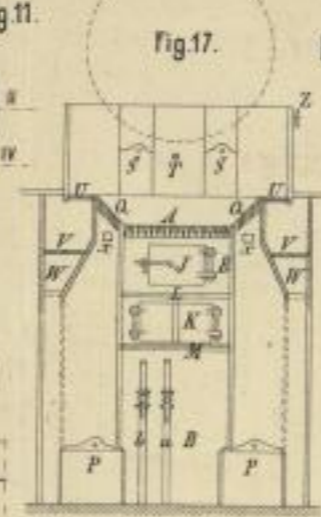
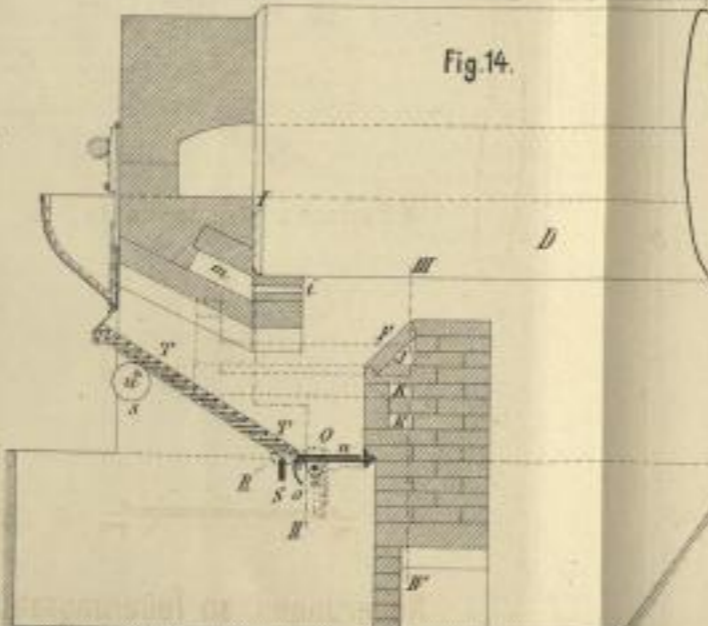
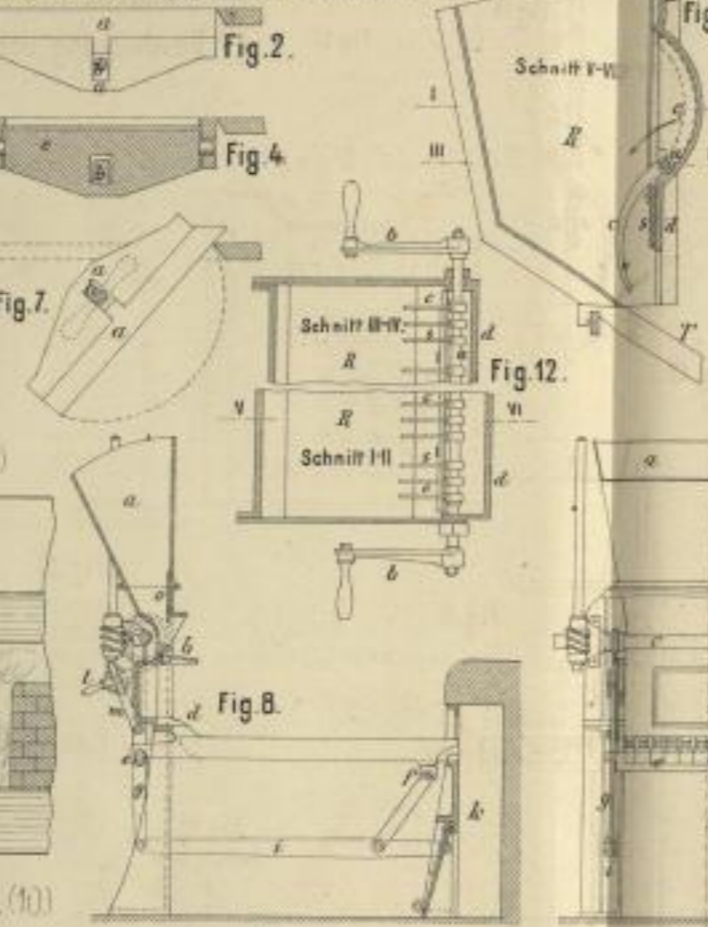
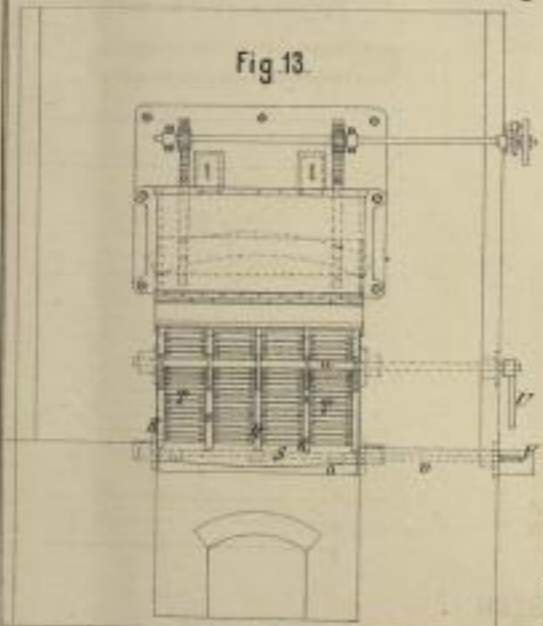

Neuerungen an Feuerungsanlagen. (1-22)

Lith. Anst. v. W. W. W. Darmstadt.



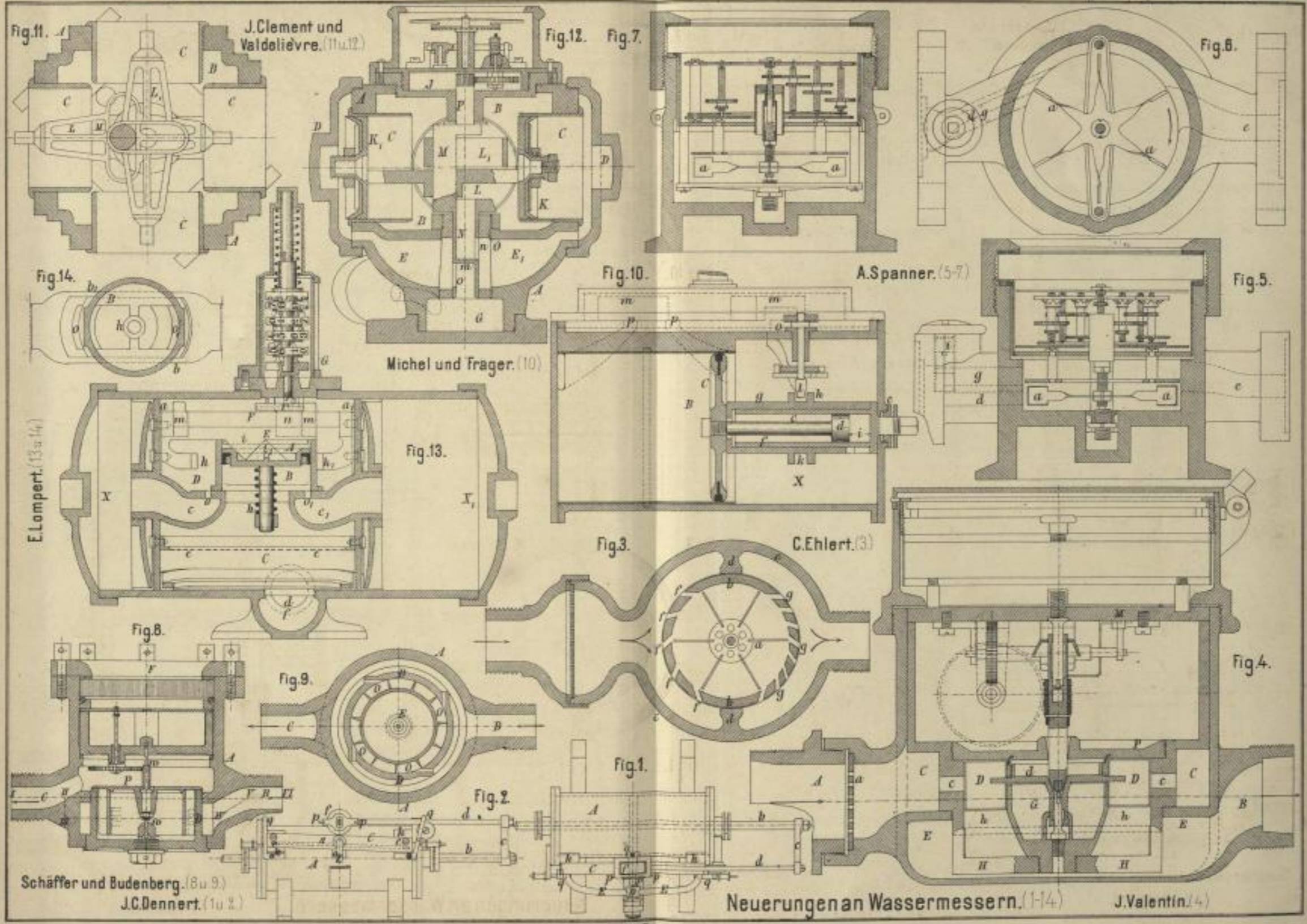

Isch. Anst. v. F. W. v. Dornstadt



Neuerungen an Lampen. (8-24)

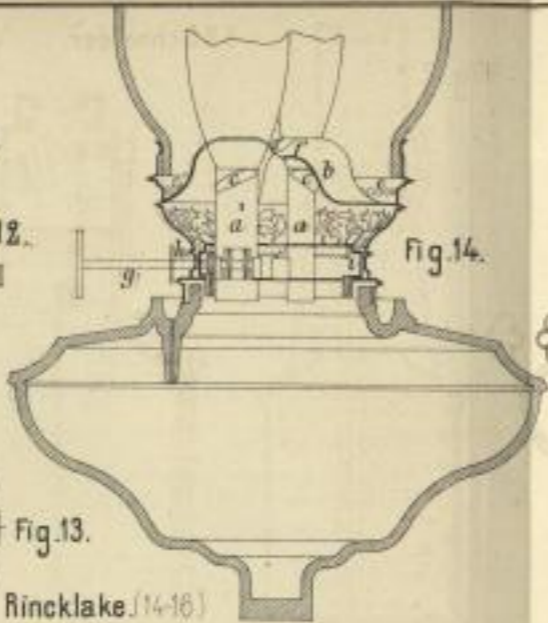
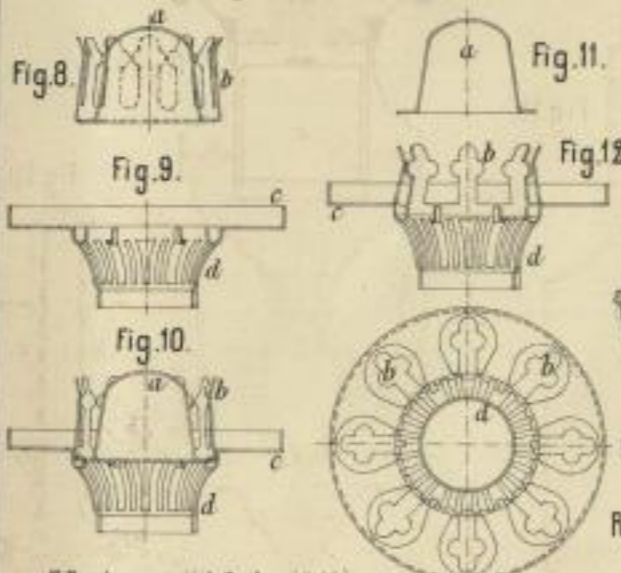

Rincklake (14-16)

F. Budweg und Sohn. (8-13)



R. Mante (21 u. 22)

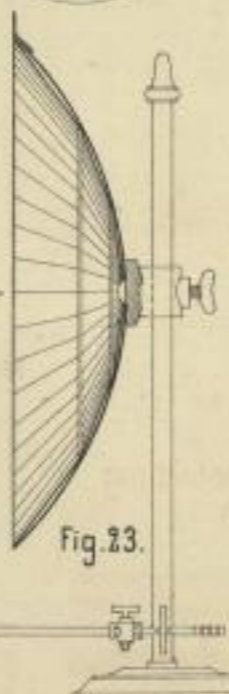
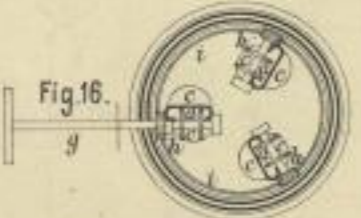

J. W. Böpel (23 u. 24)

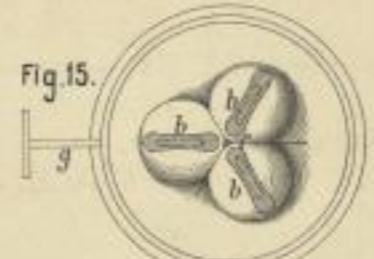

Jacquardkarten-

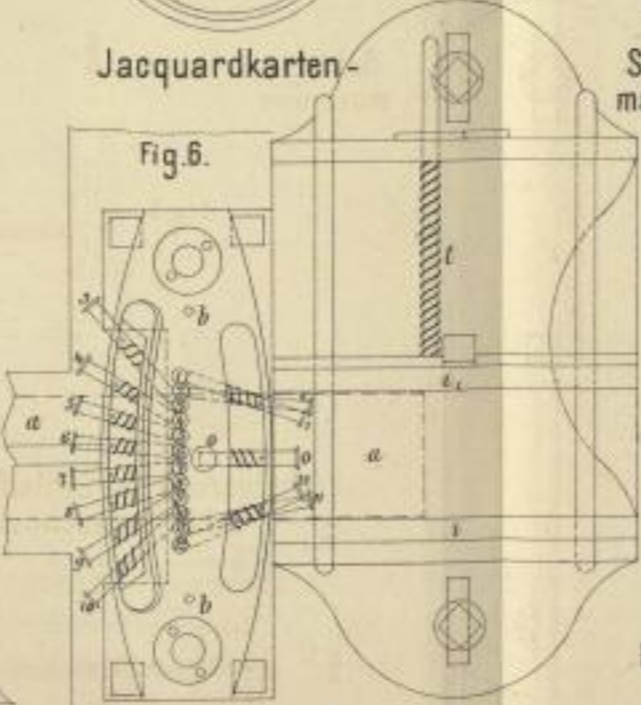

Palmer's Schlauchdüse. (1)

Isch. Anst. v. P. Wirtz, Jena

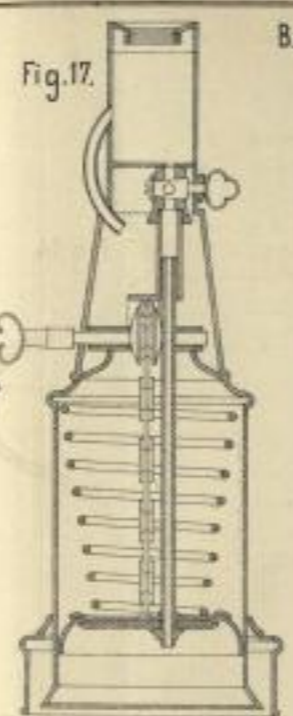

B.B. Schneider. (17 u. 18)

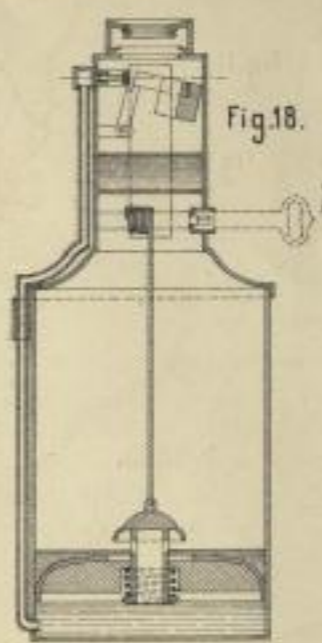

Schlagmaschine. (5-7)



Verhinderung der Schleifenbildung bei Mülmaschinen. (2)

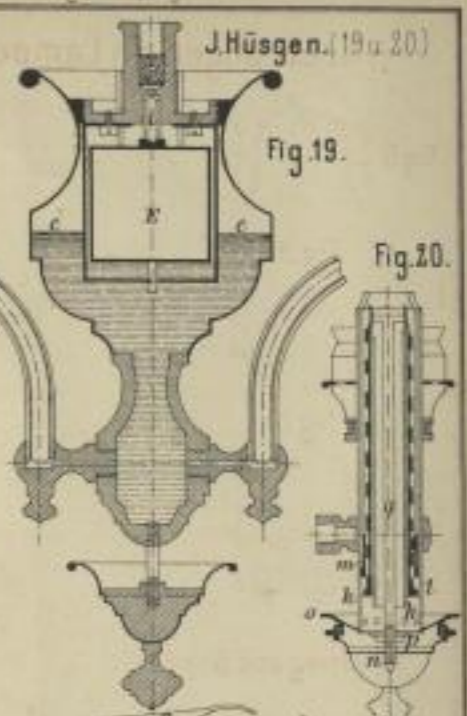
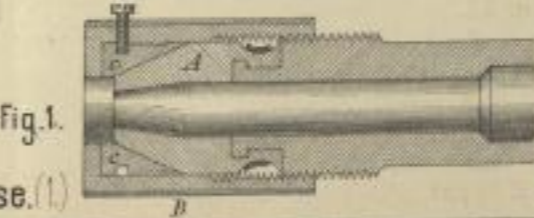

J. Hüsgen. (19 u. 20)

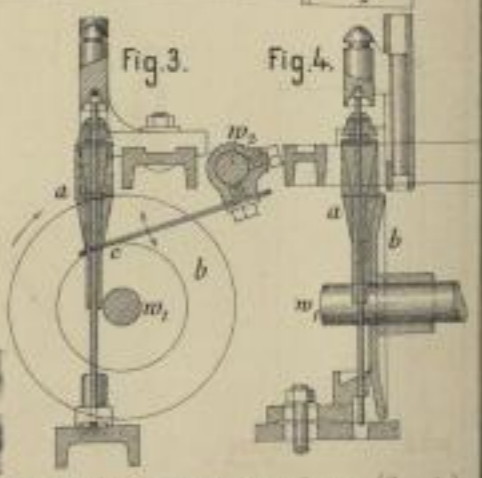
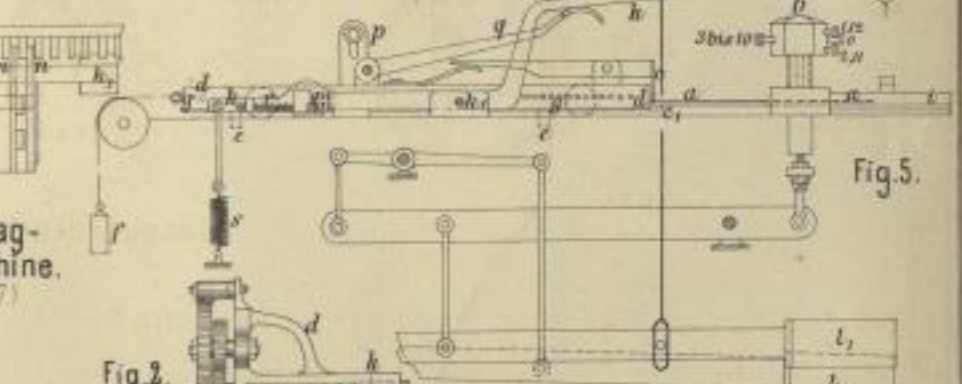

Hacking's Spulmaschine. (3 u. 4)





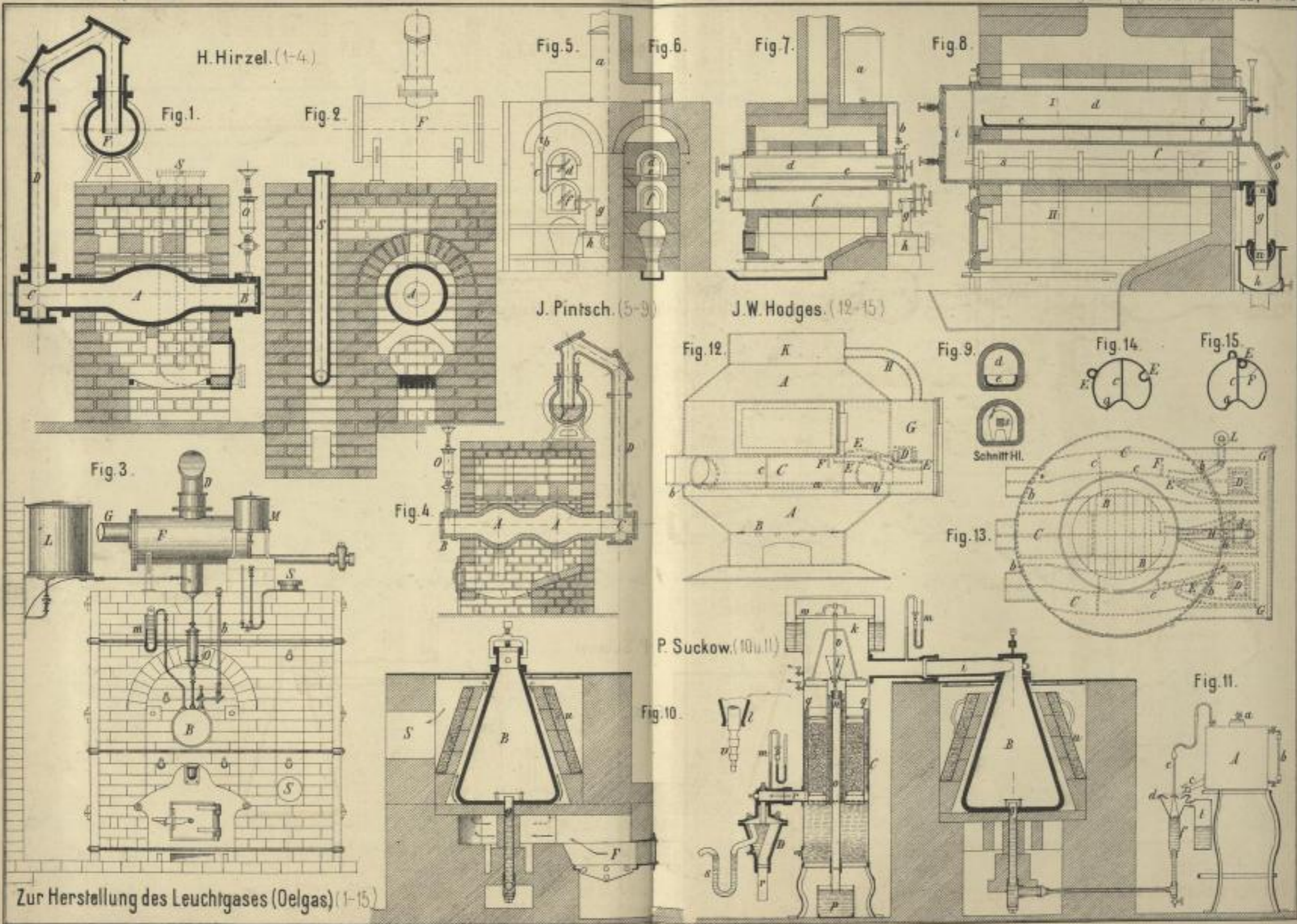

Zur Herstellung des Leuchtgases (Delgas) (1-15)

Isb. Anstalt v. P. W. W. Darmstadt.



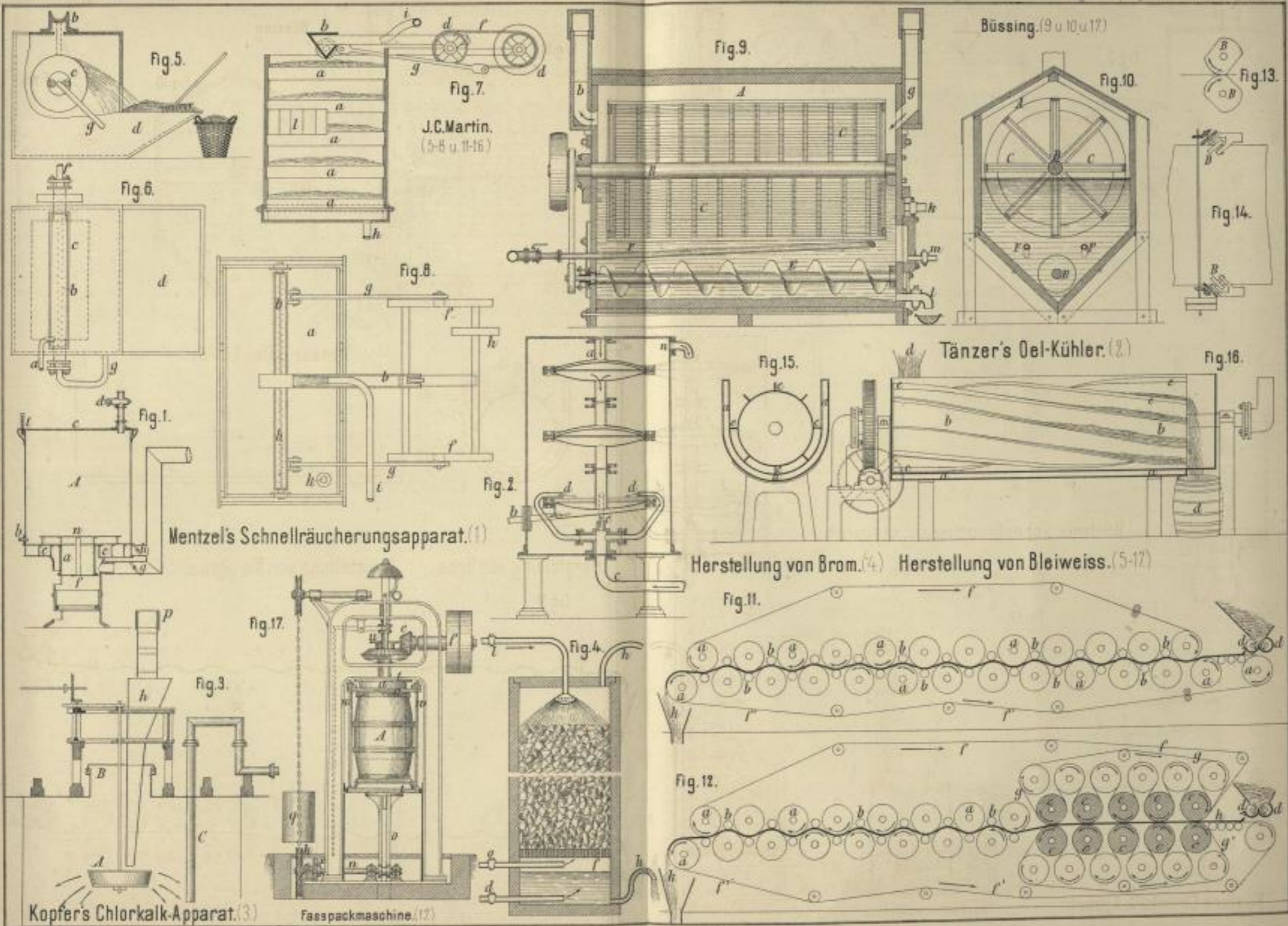

Leh. Inst. n. Würz. Darmstadt



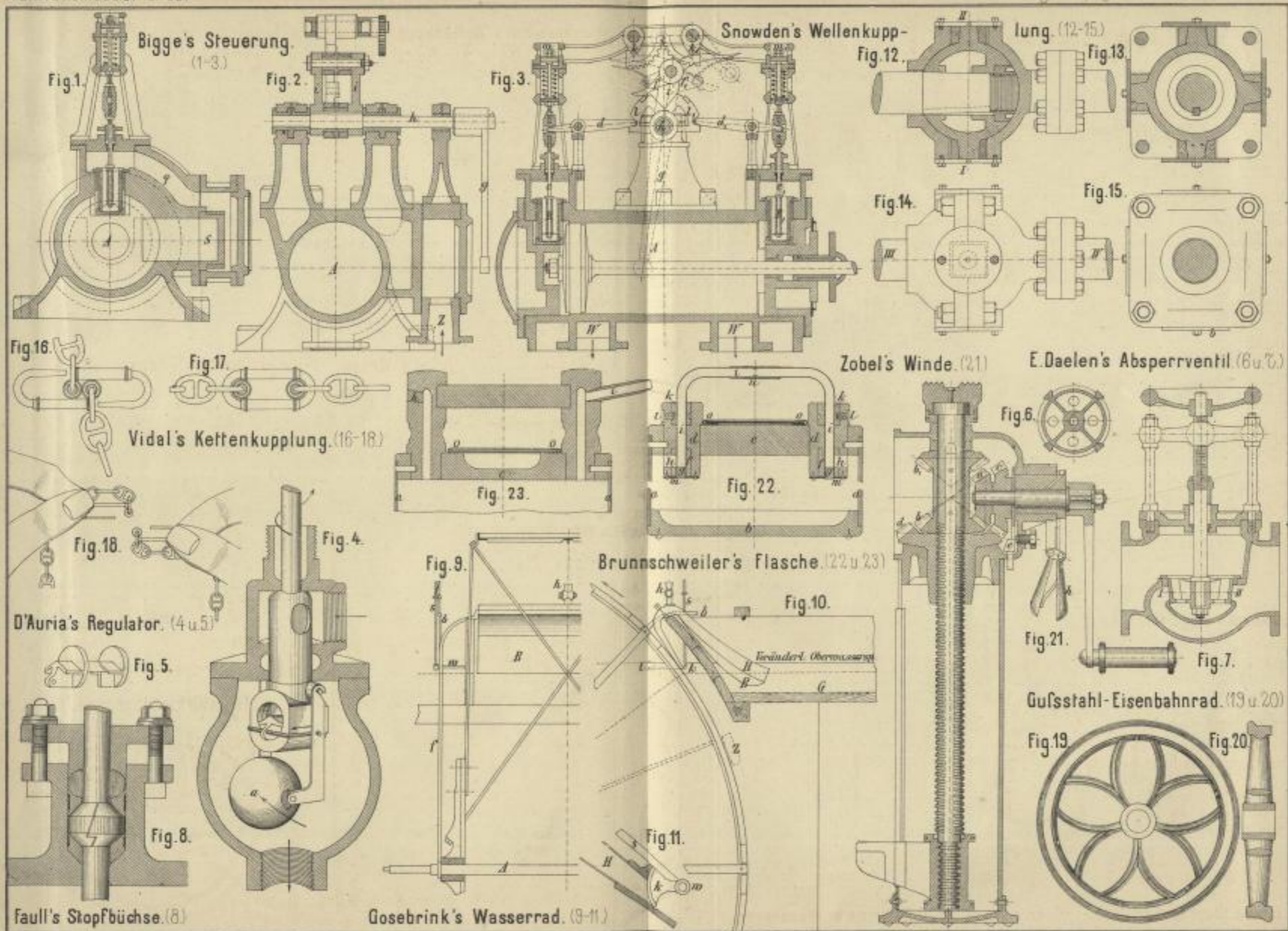

Lith. Anst. v. F. W. v. Dornstadt



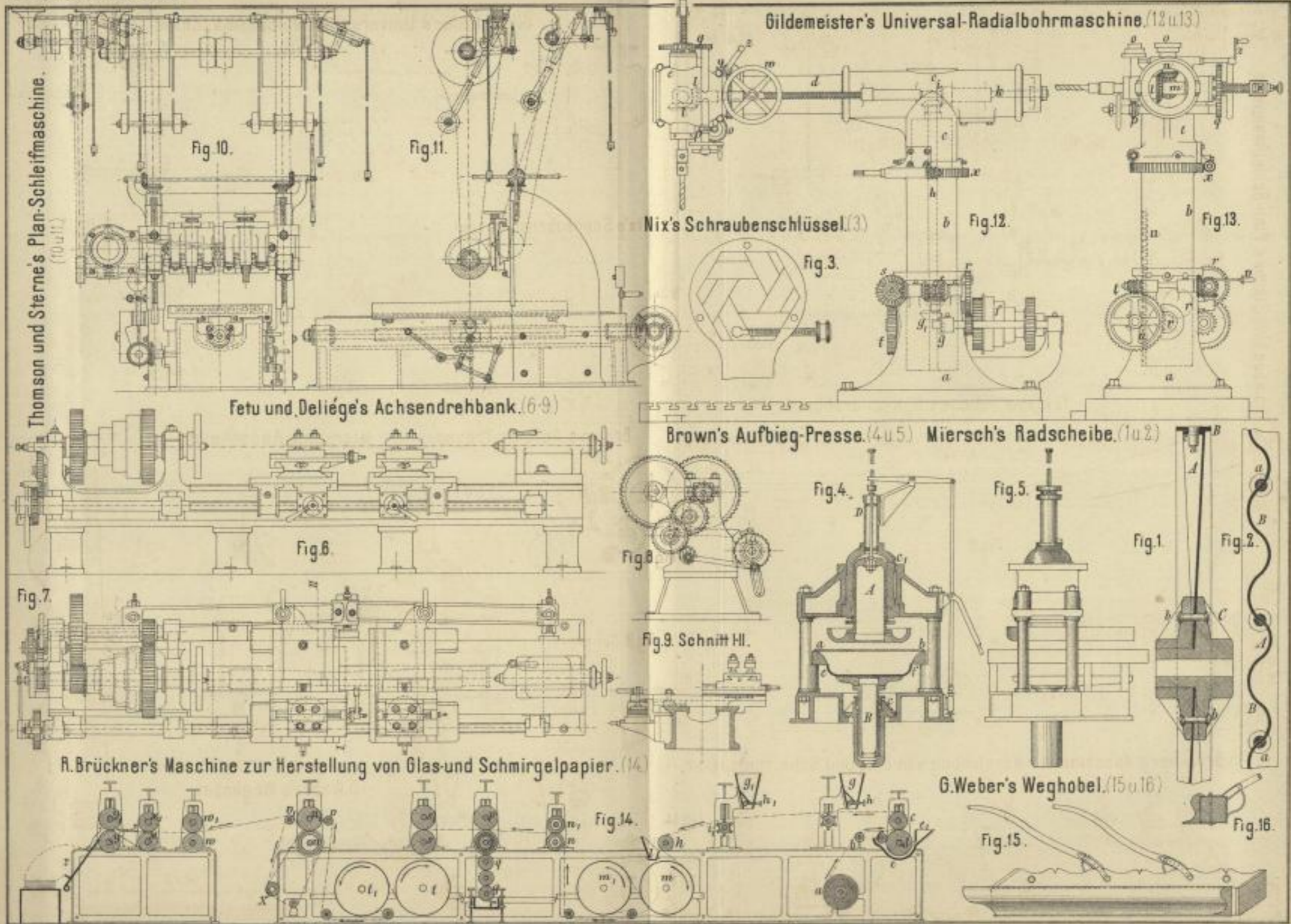

Lith. Anst. v. J. Wirtz, Darmstadt.



Ireland's Streckwerk. (13)

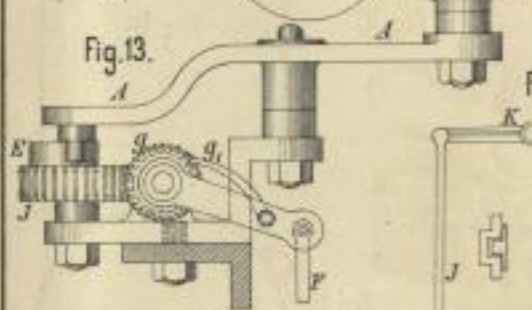

Fig. 13.

Fig. 7.

Tooth's Schienensäge. (5-7)

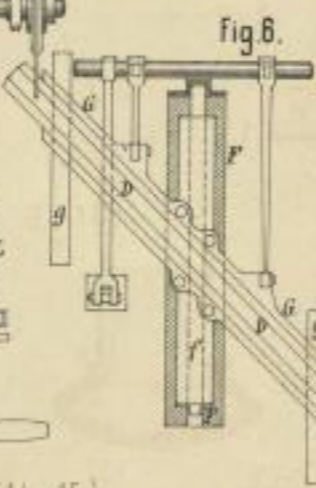

Fig. 6.

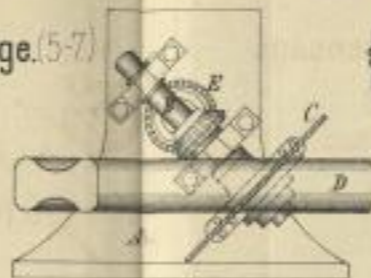

Fig. 5.

Herstellung von Stahlketten. (1-4)

Nielsen's Polirwerkzeug. (9 u. 10)

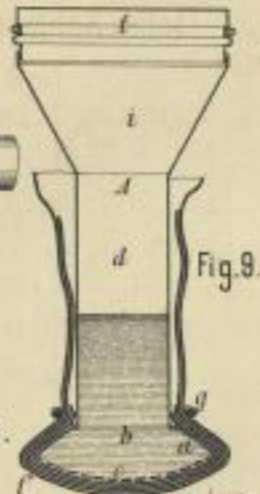

Fig. 9.



Fig. 10.

Kähler's Anzündofen. (18 u. 19)



Fig. 18.



Fig. 19.

Lairve's Garnbaumbremse (14 u. 15)



Fig. 14.

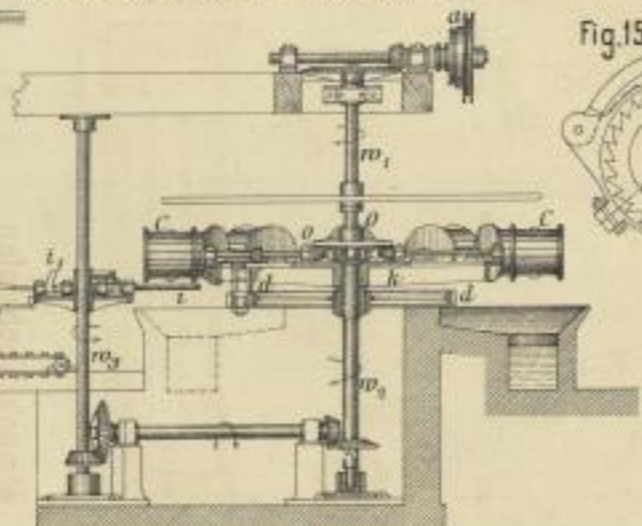

Fig. 15.

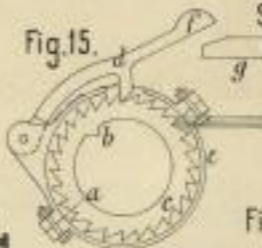
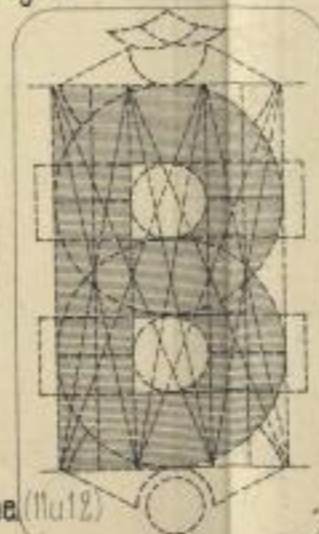

Fig. 15.

Fig. 1.

Schnitt VII.

Fig. 11.



Lab. Anst. v. B. Pötsch, Darmstadt.

Fig. 3.

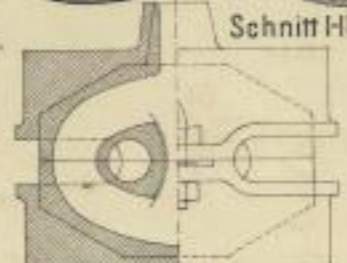

Schnitt III.

Fig. 4.

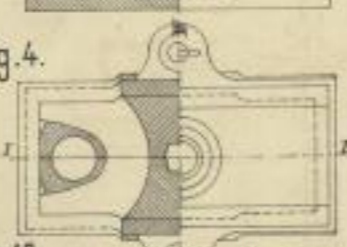

Fig. 12.

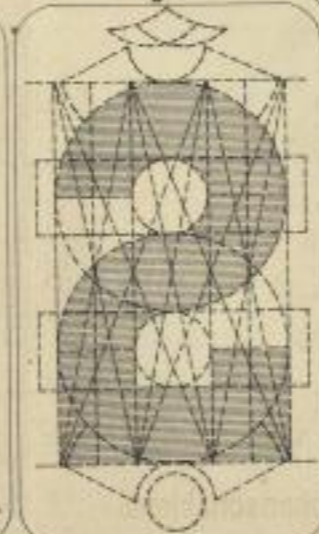
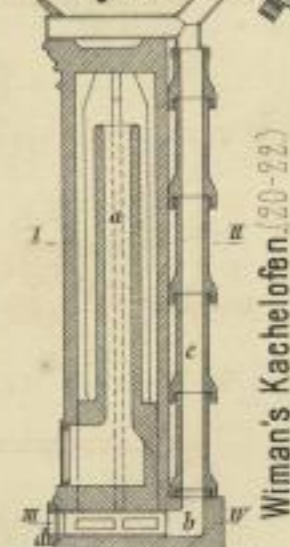

Fig. 20.



Wiman's Kachelofen. (20-22)

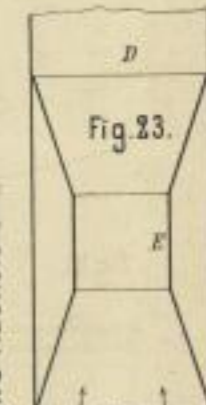
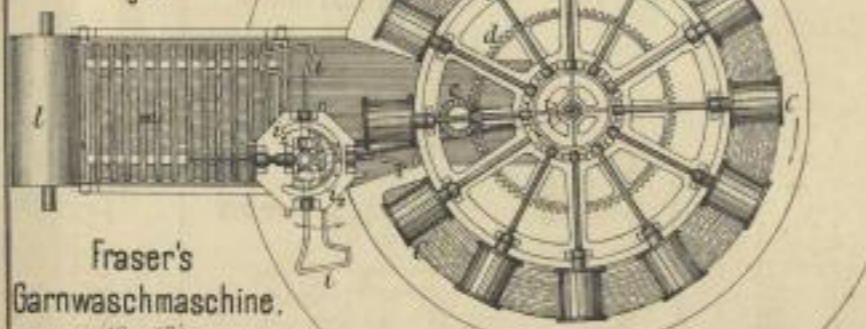

Fig. 23.

Fig. 17.



Fraser's Garnwaschmaschine. (16 u. 17)

J.A. David's Zeichenschablone (11 u. 12)



Fig. 8.

Hart's Druckstahl. (8)

Fig. 21.

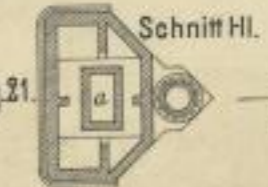

Schnitt III.

Fig. 22.

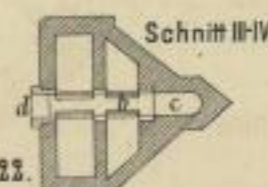

Schnitt II-IV.

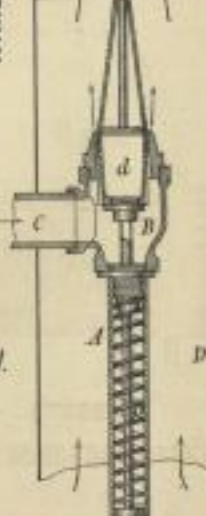

Lüftungsapparat. (23)



Gust. Hempe (1 u. 2)

Neuerungen an Wassermessern (1-13)

W. Holdinghausen (9 u. 10)

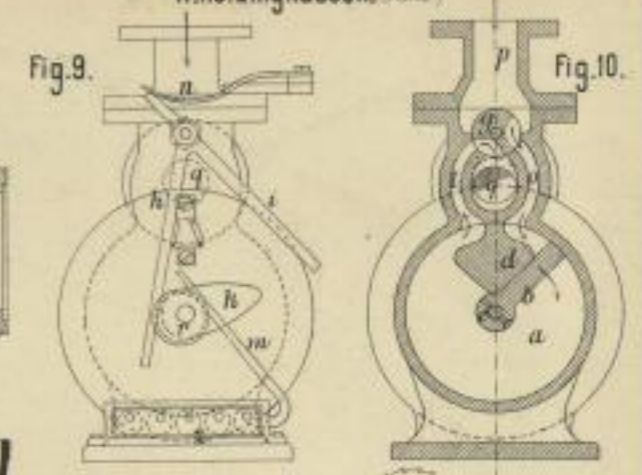
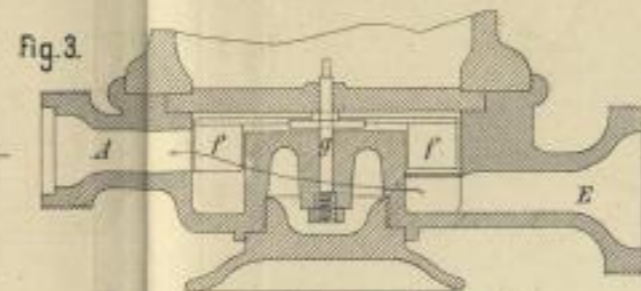
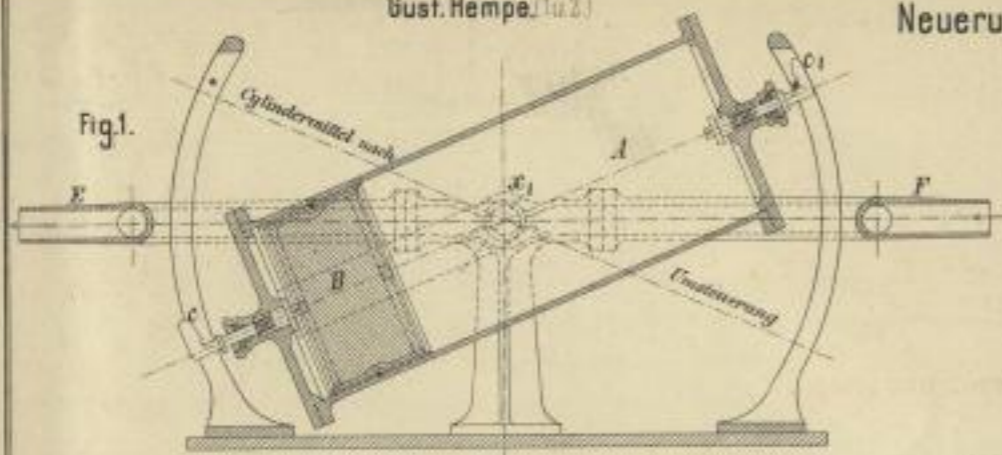

Dreyer, Rosenkranz und Droop (3)

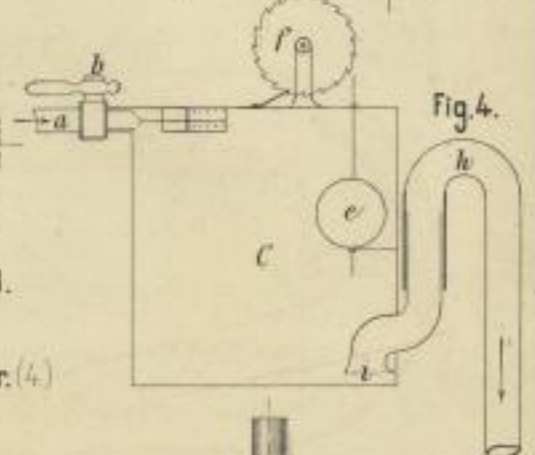
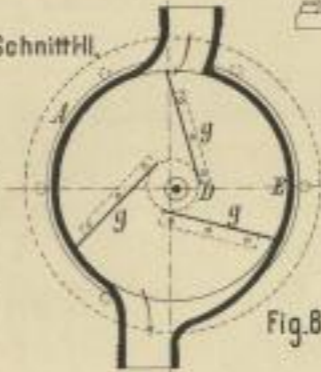
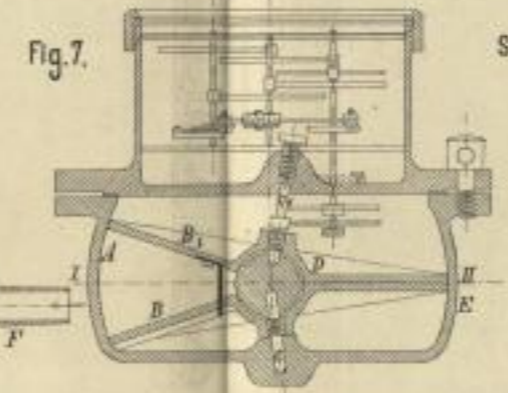
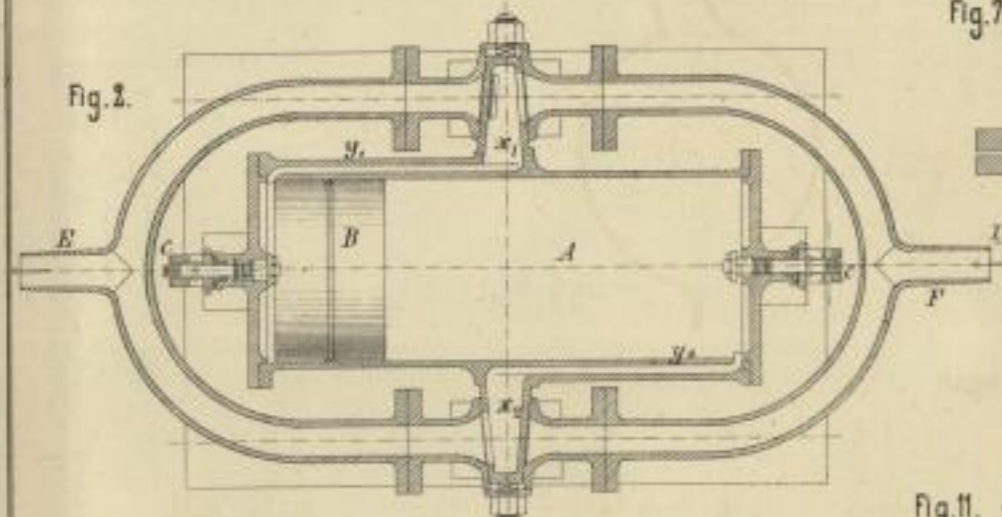

H. Kröger (7 u. 8)

J. A. Müller (4)

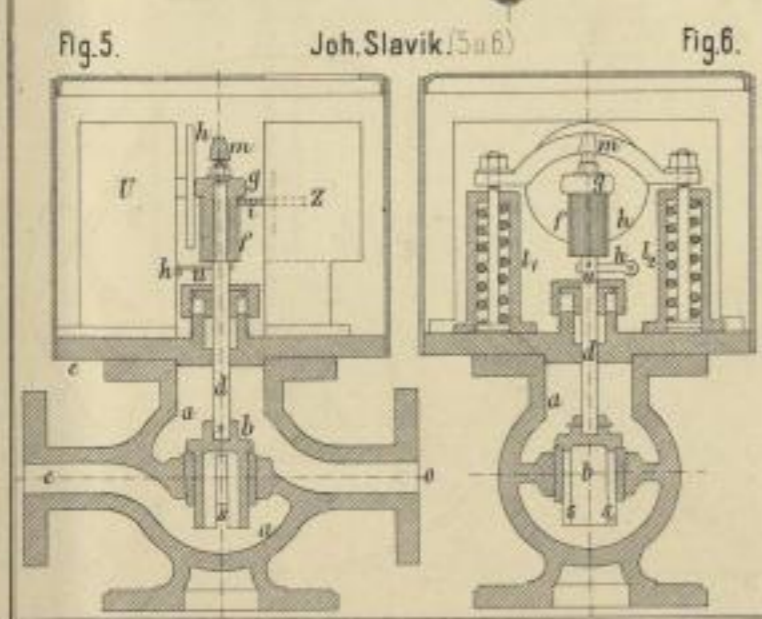

Joh. Slavik (5 u. 6)

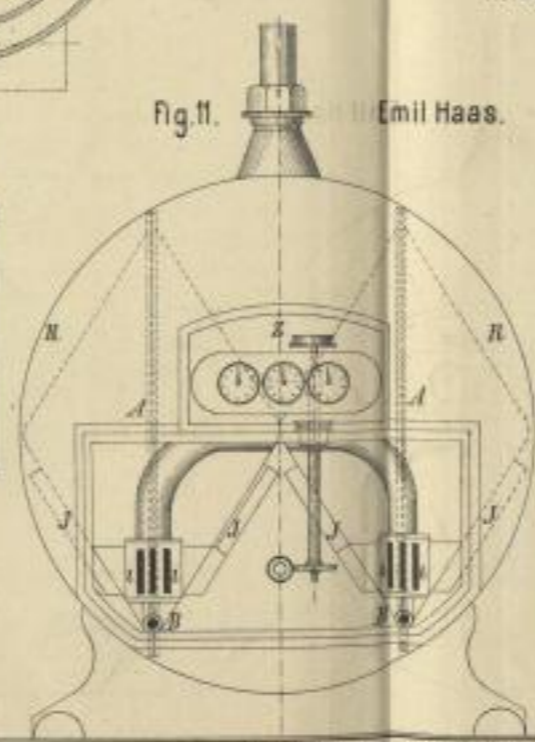

Emil Haas

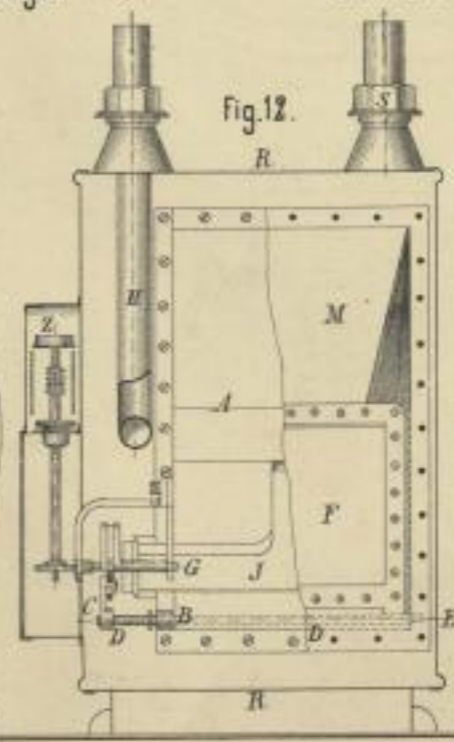

Fig. 12

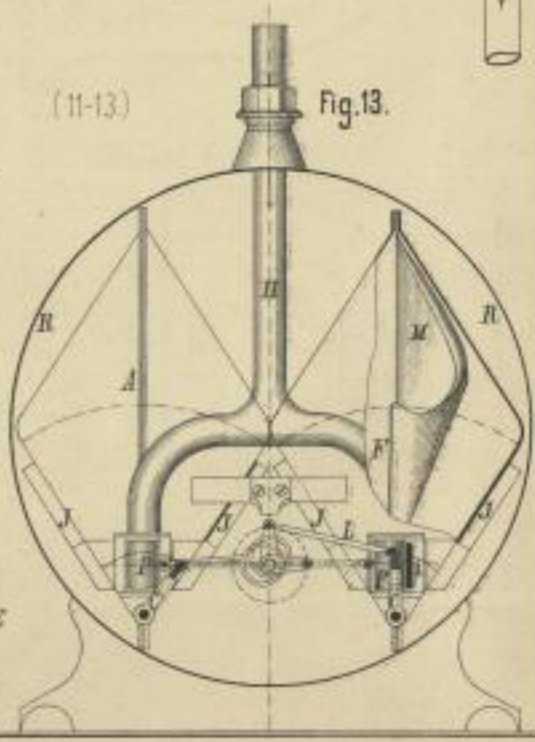
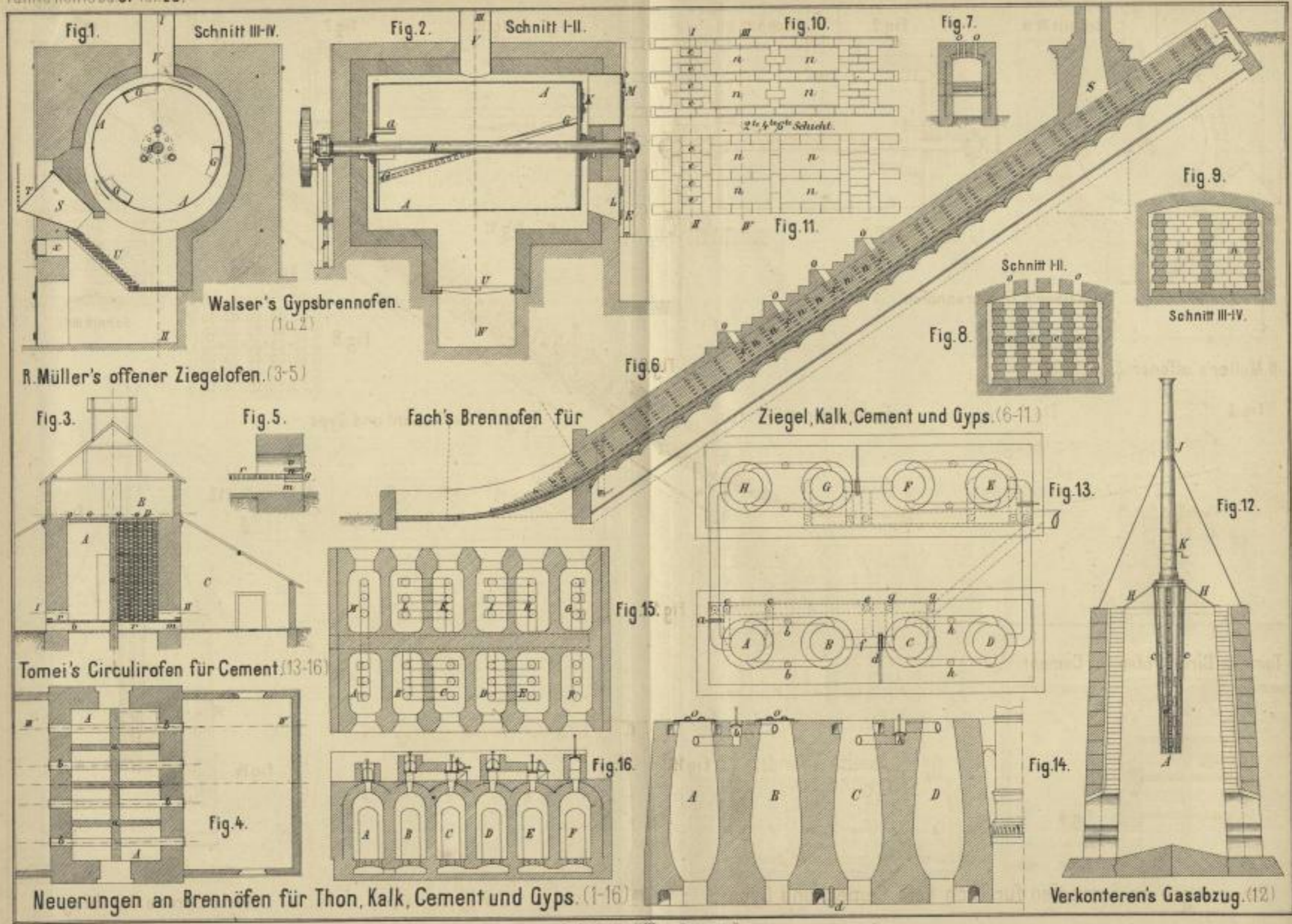

Fig. 13

Verf. Anst. v. F. Wöck, Darmstadt





Lith. Anst. v. F. Wörck, Darmstadt



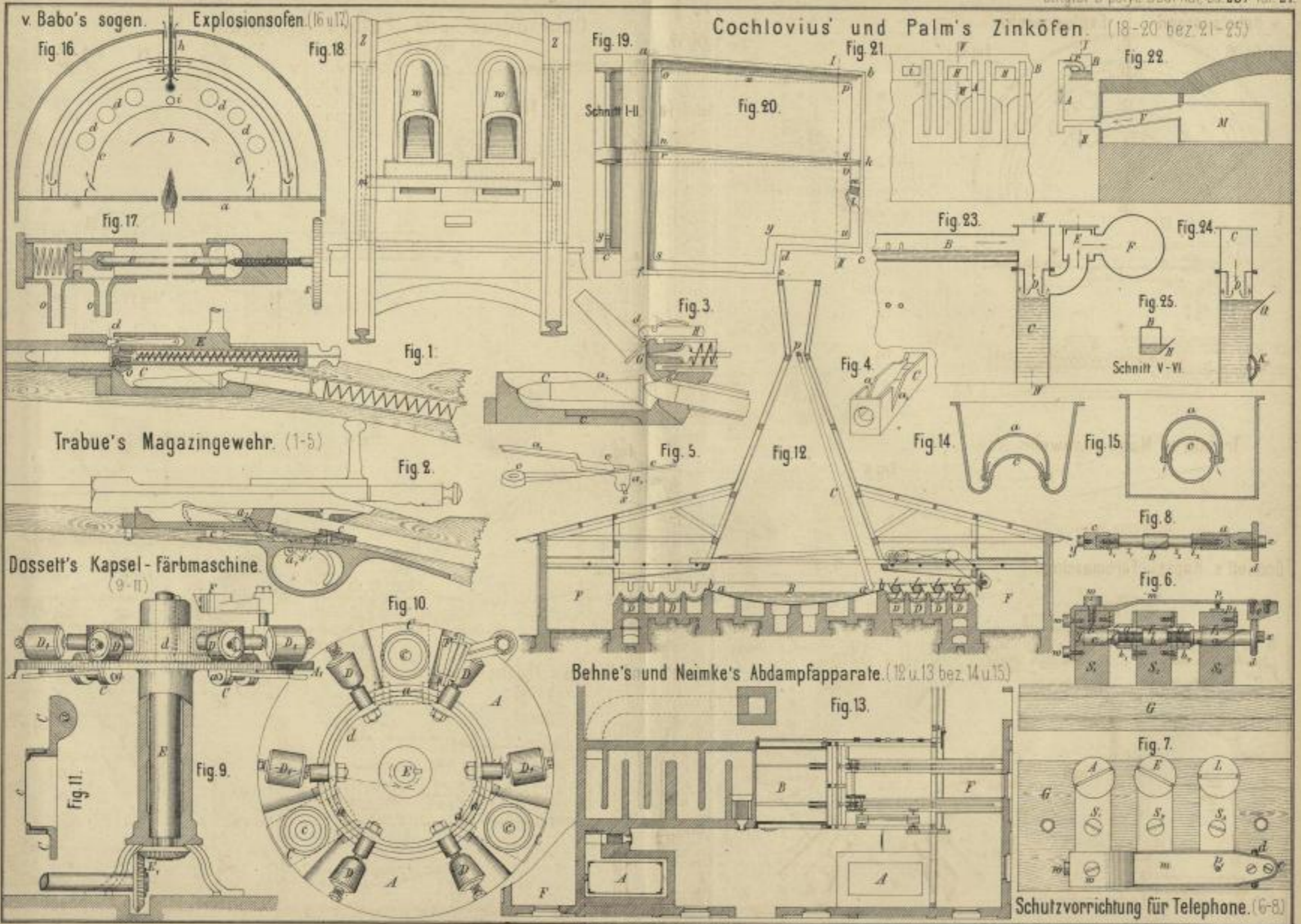

Isch. Anst. v. F. Wirtz, Darmstadt.



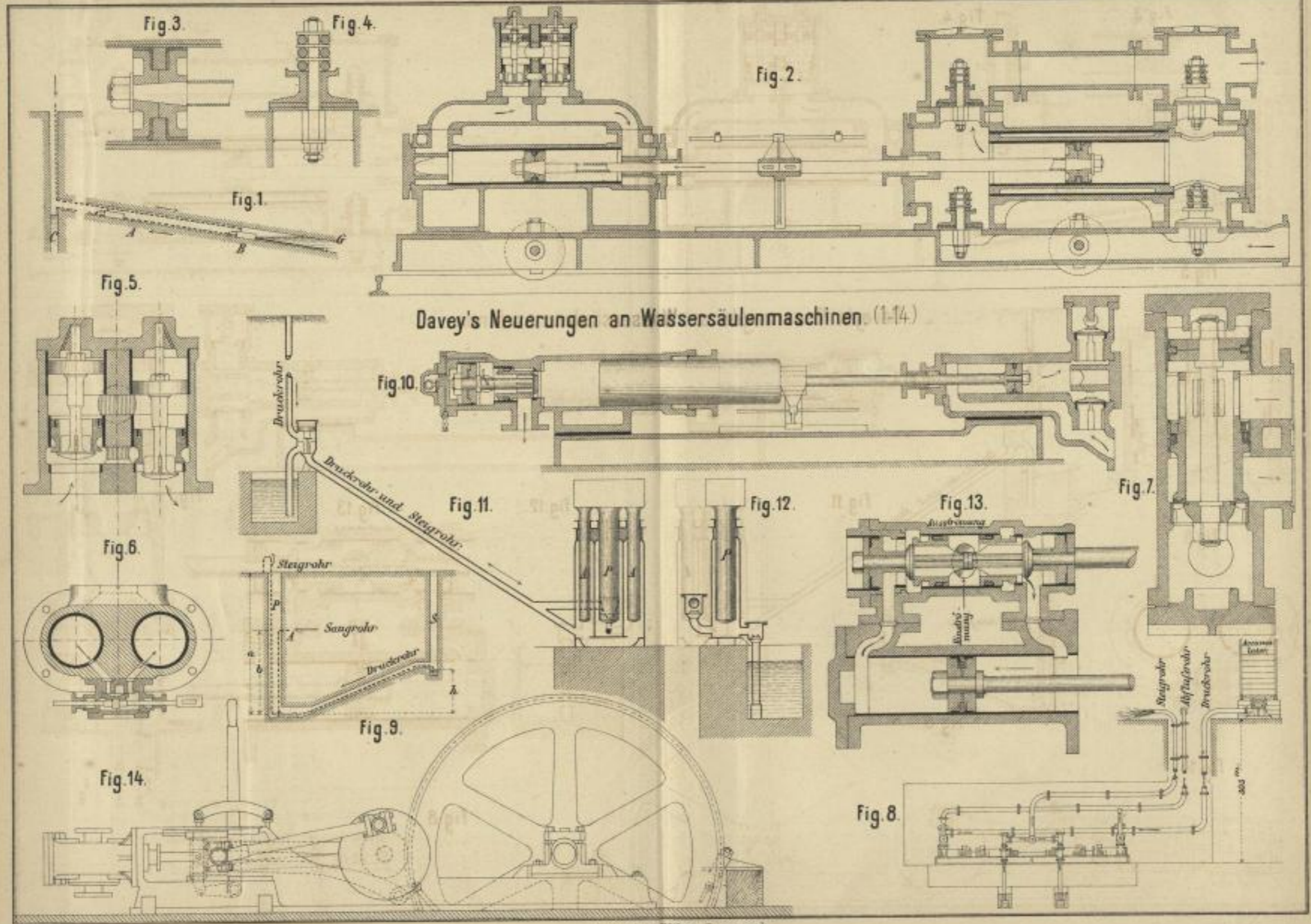



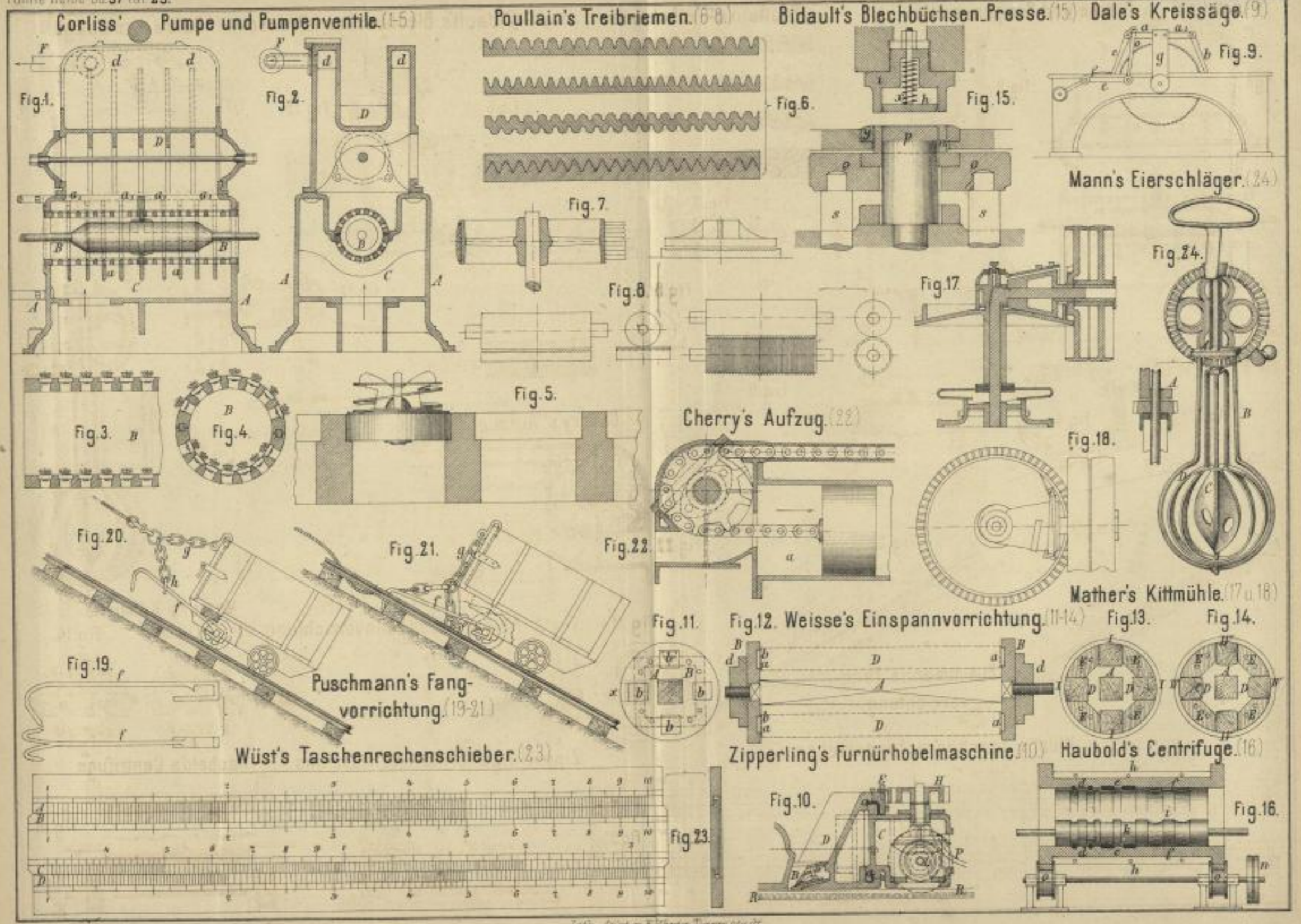

Lith. Anst. v. F. Witz, Darmstadt.



Neuerungen an Feuerungs-Anlagen. (10-20)  
Clouet's und Rossenbeck's Zugregulatoren. (10-12)

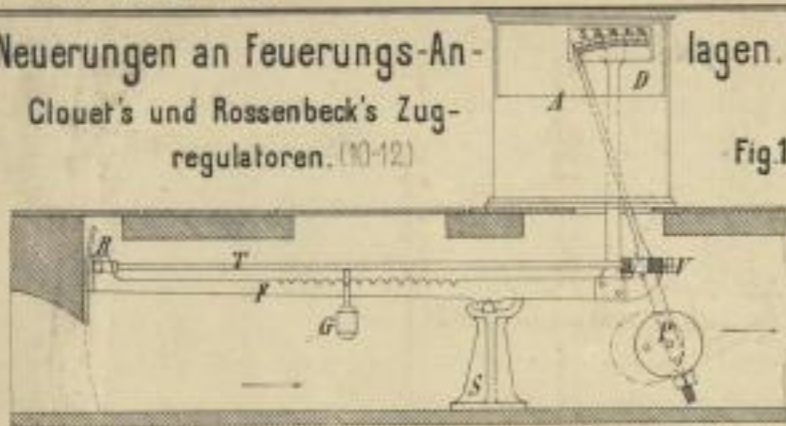

Fig. 10.

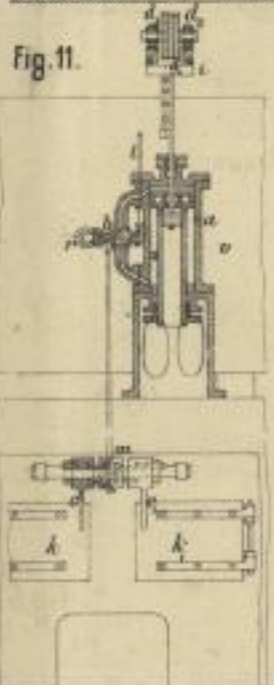

Fig. 11.

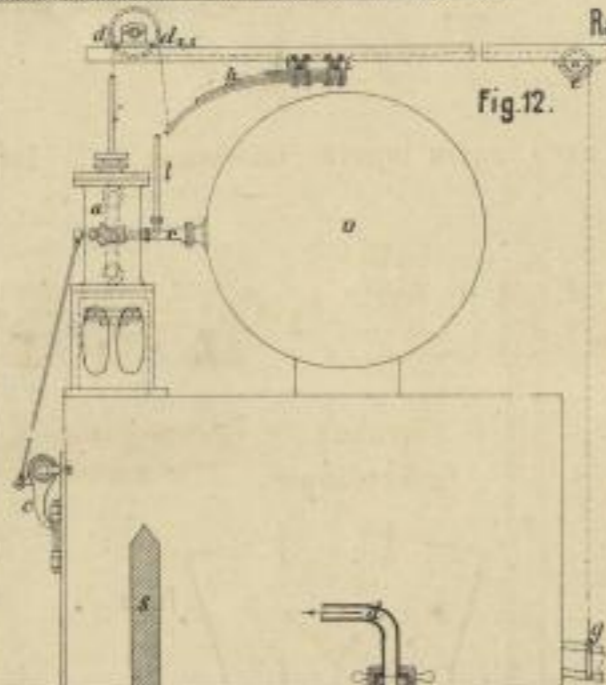

Fig. 12.

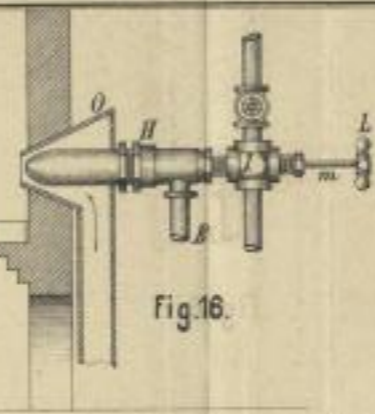

Fig. 16.

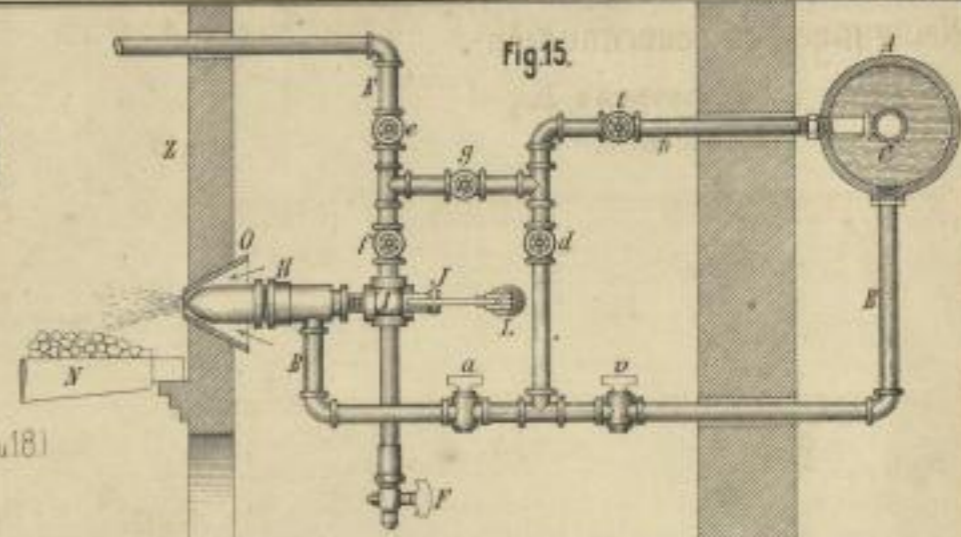

Fig. 15.

Rauchverzehrende Feuerung. (17 u. 18)

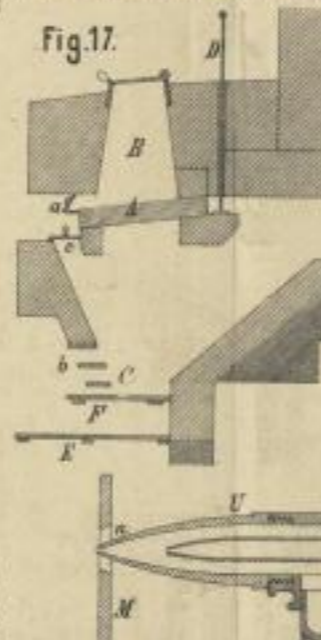

Fig. 17.

Salisbury's und Rogers' Injector-Feuerungen. (13-16) Einmauerung (19)

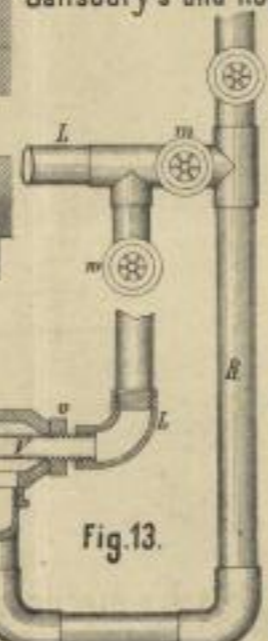

Fig. 13.



Fig. 18.

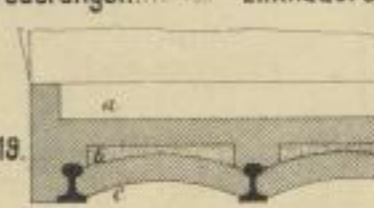

Fig. 19.

Strube's Funkenfänger. (20)

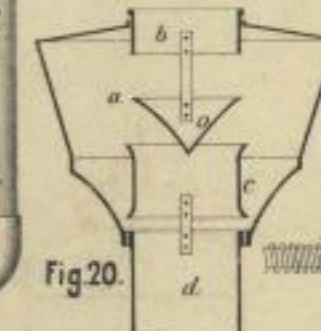

Fig. 20.



Fig. 14.



Fig. 1.



Fig. 2.

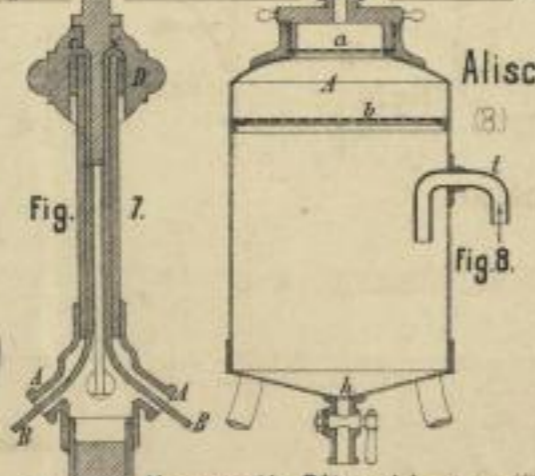

Fig. 7.

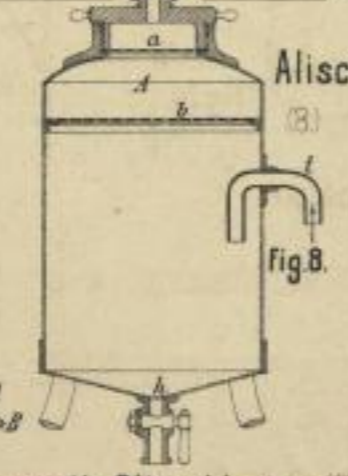
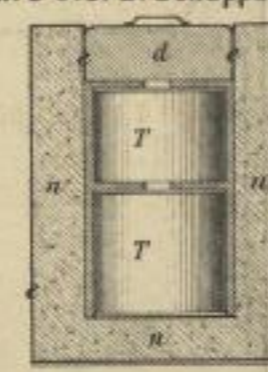

Fig. 8.

Alisch's Bierdruckapparat. (3)



Meyn's Kochapparat. (9)

Fig. 9.

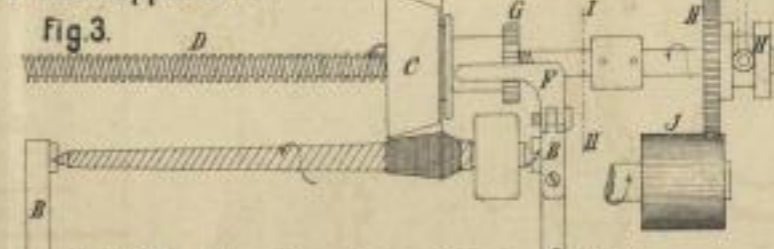

Fig. 3.

Adolff's Schufsspulmaschine. (3-6)



Fig. 4.

Schnitt III.

Haines' Seilhaken. (1 u. 2)

Kernaul's Blitzableiter. (1)

lith. Anst. v. F. W. G. v. Dornstadt.



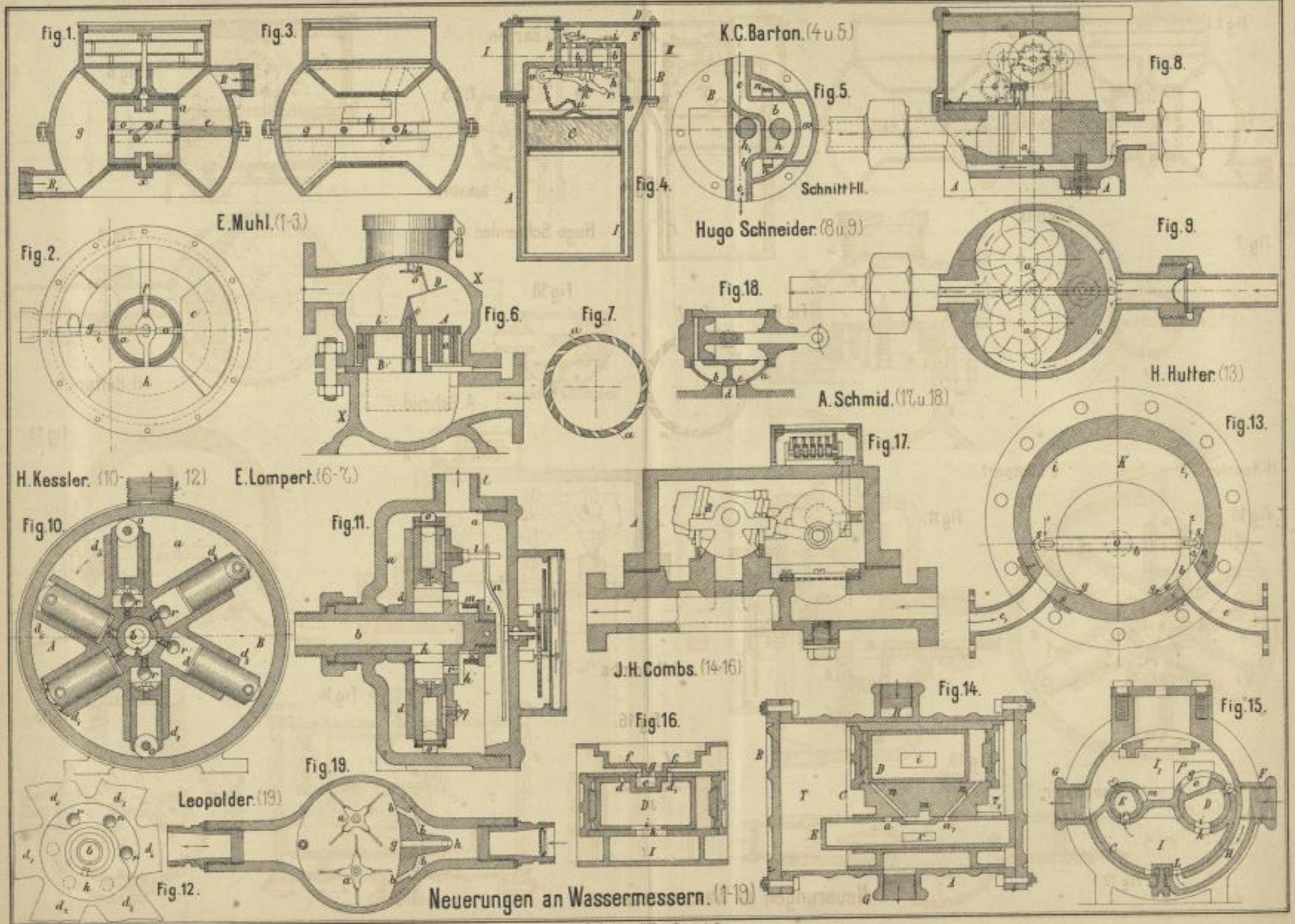

Inch. 1/32 u. 1/64 Zoll. 1/16 u. 1/32 Linie



Tragapparat für Säureballons. (1 u. 2)

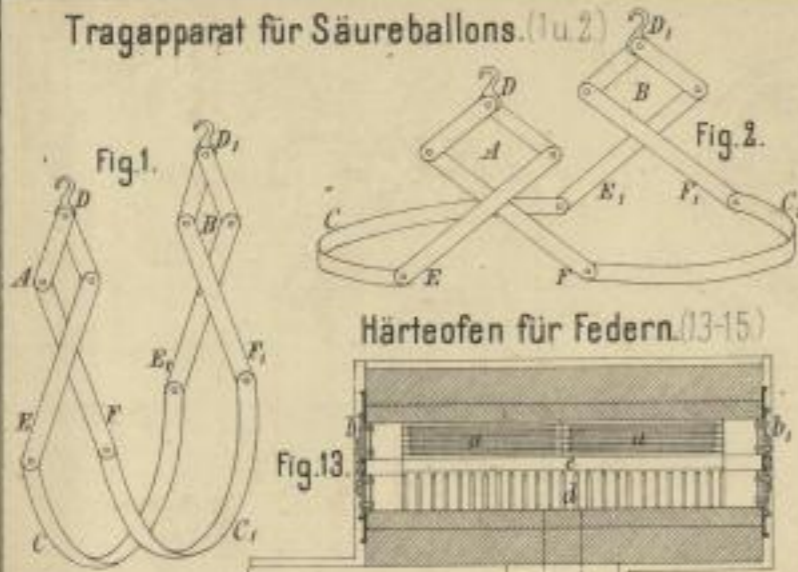

Härteofen für Federn. (13-15)

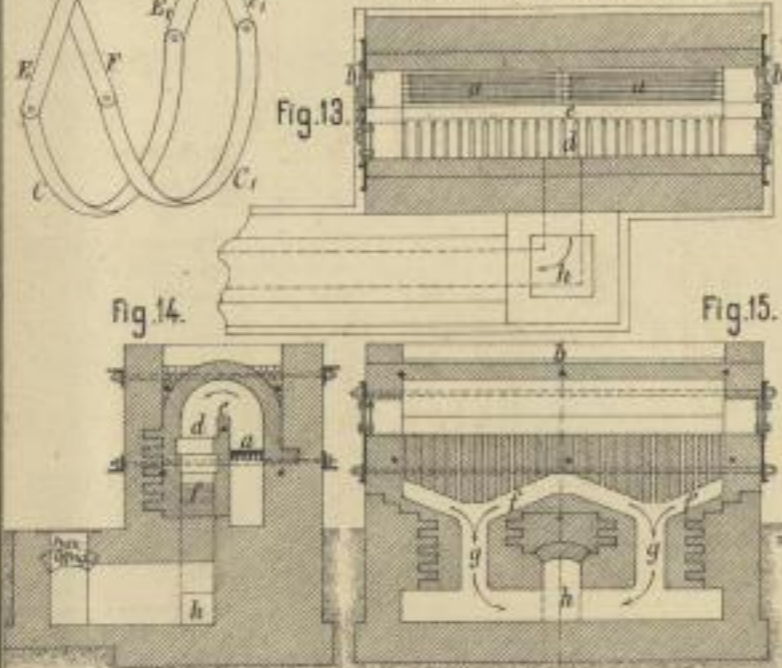

Speller's elektrische Uhr. (11 u. 12)

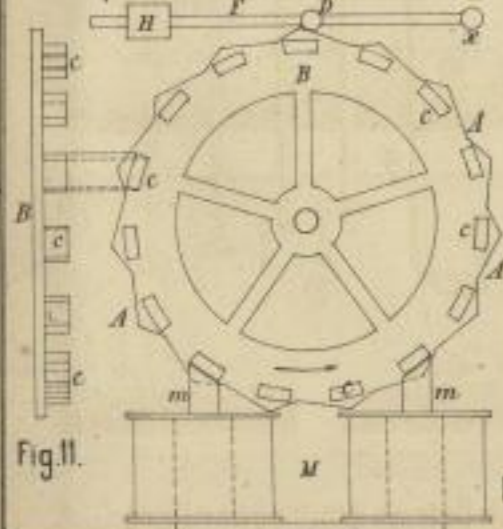

Fig. 8.

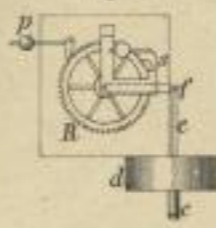

Fig. 9.

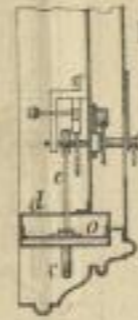

Fig. 10.

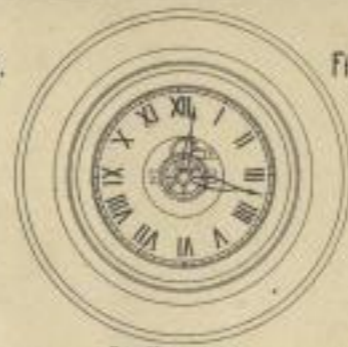

Fig. 6.

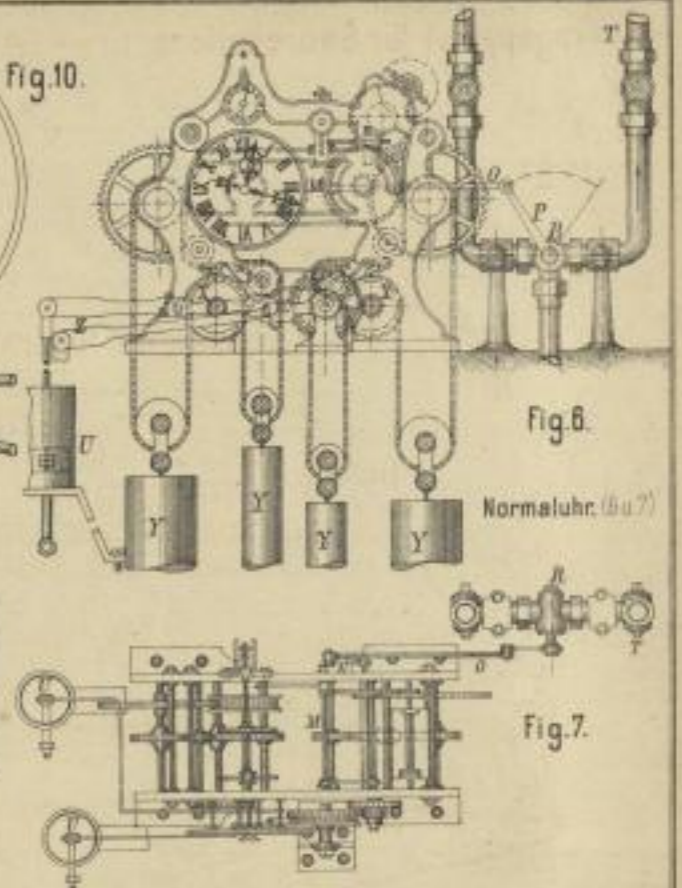

Fig. 7.

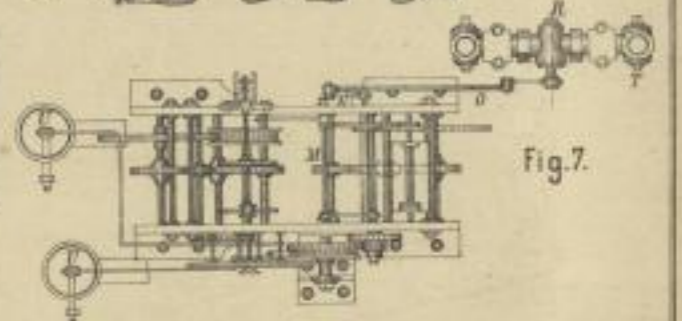

Fig. 5.

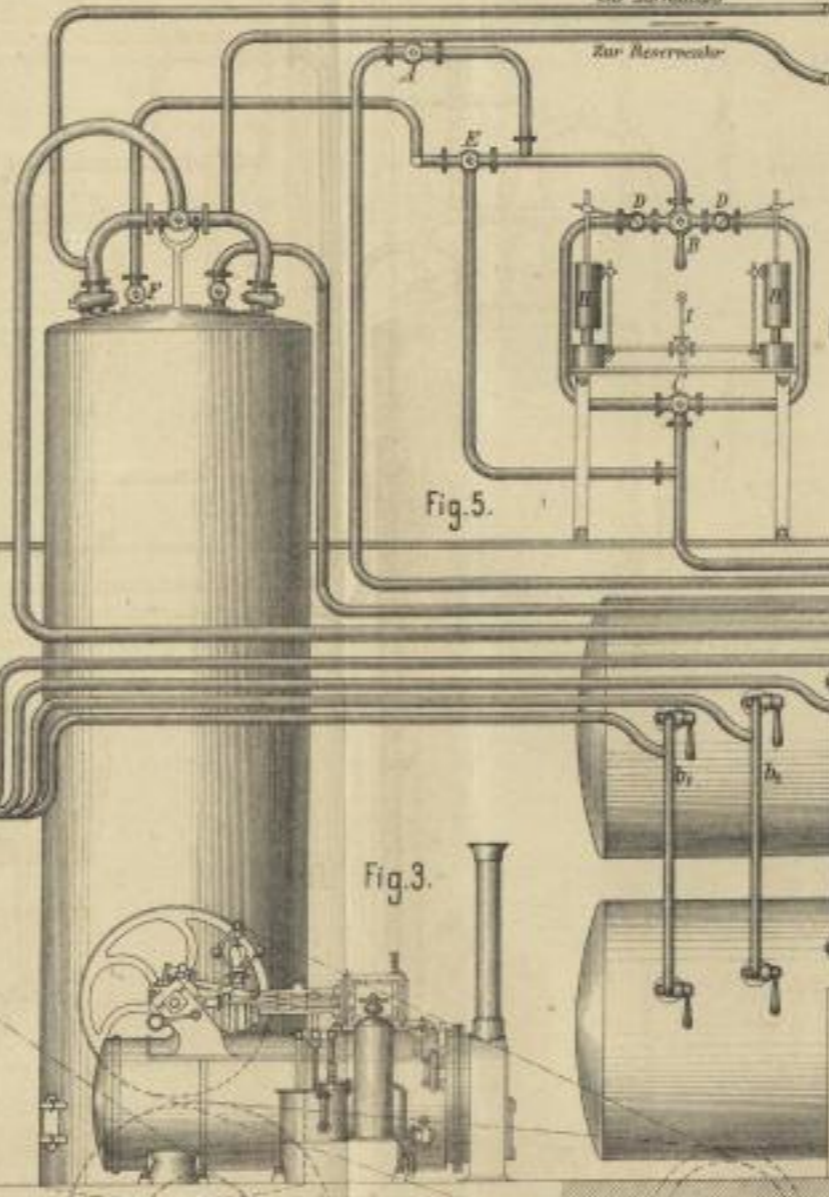
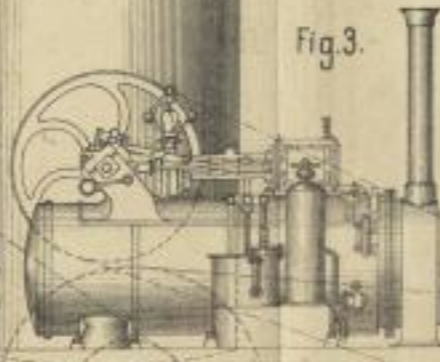

Fig. 3.



System Mayrhofer.

Pneumatischer Betrieb städtischer Uhren. (3-10)

Lith. Anst. v. F. W. v. S. v. J. v. S.



Neuerungen an Kokesöfen. (1-9)

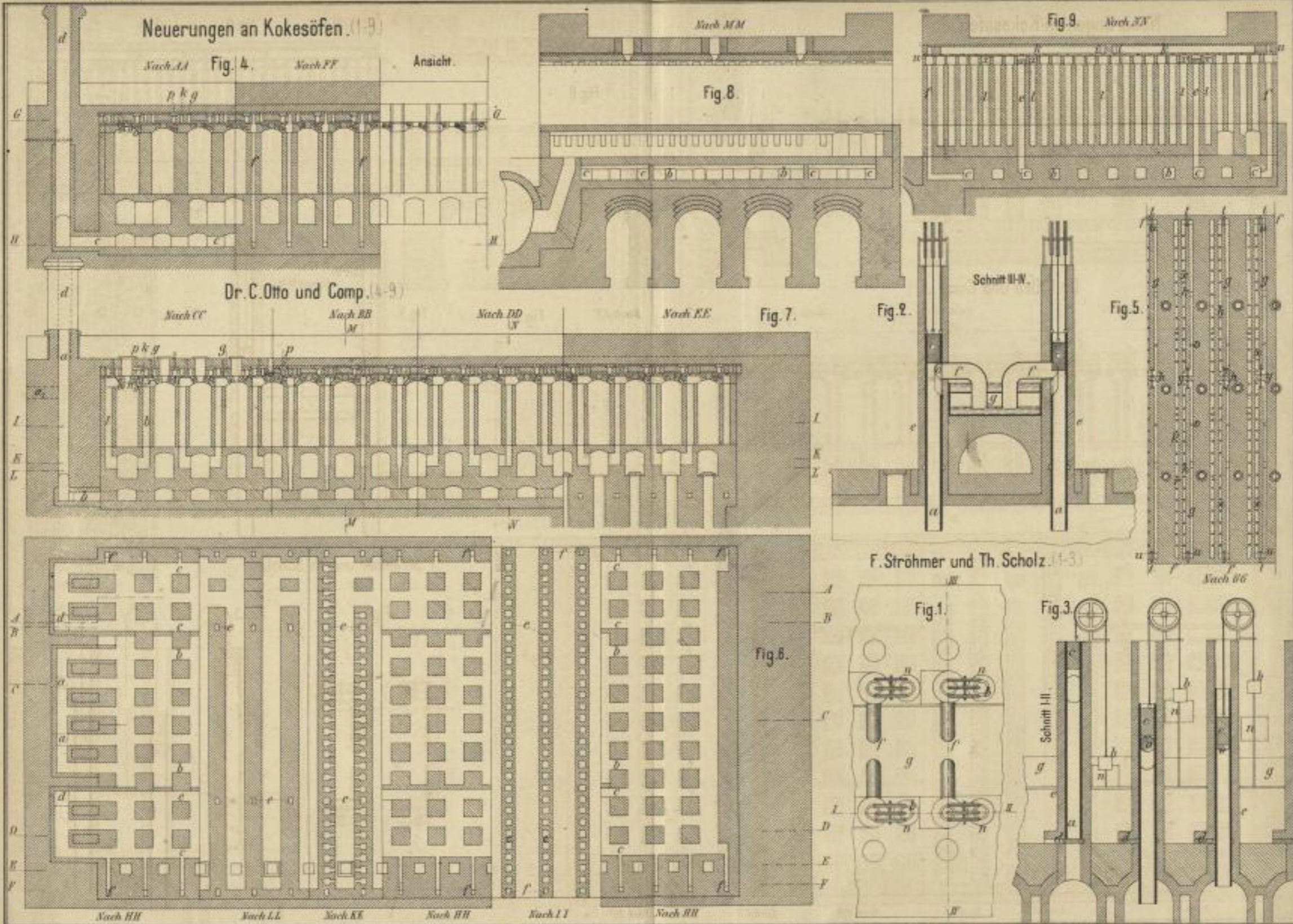

Dr. C. Otto und Comp. (4-9)

F. Strömer und Th. Scholz. (1-3)

Lith. Anst. P. Witz, Darmstadt





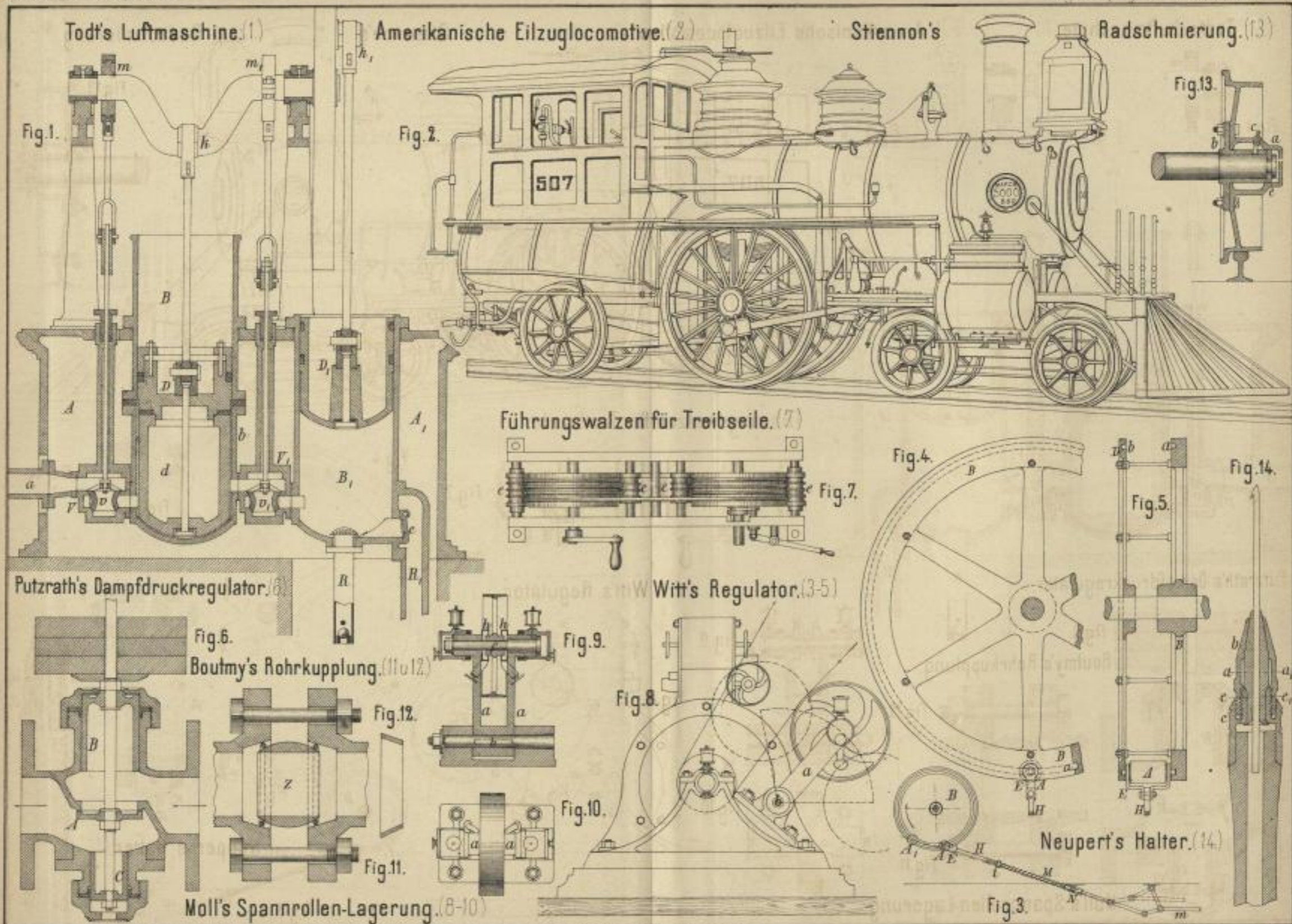

Lith. Anst. v. P. Witz Darmstadt.



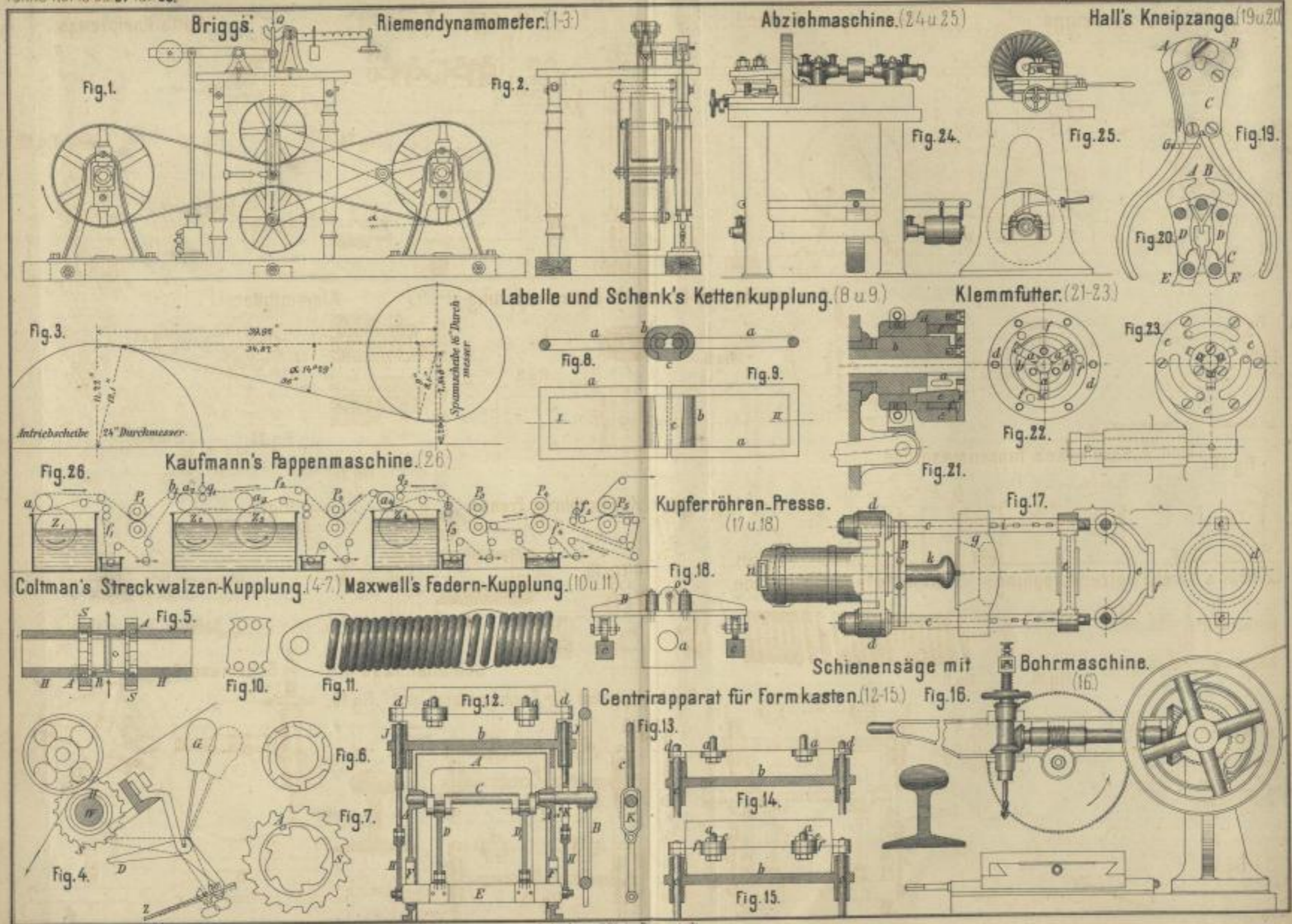

lith. Anst. v. F. W. v. Dornstadt.





G. Meyer's Maschine zum Prüfen der Radreifen. (1-4)

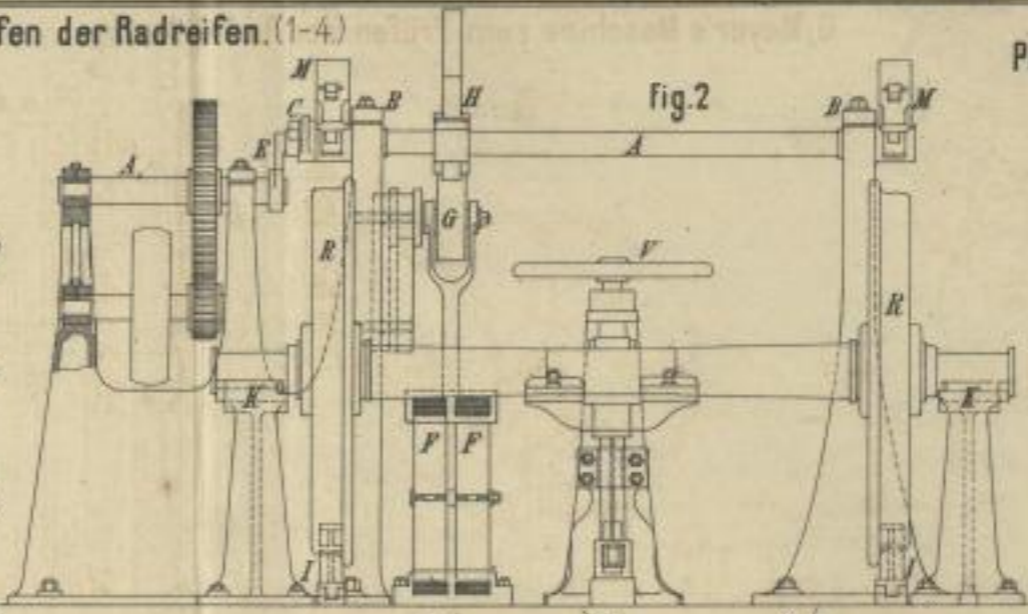
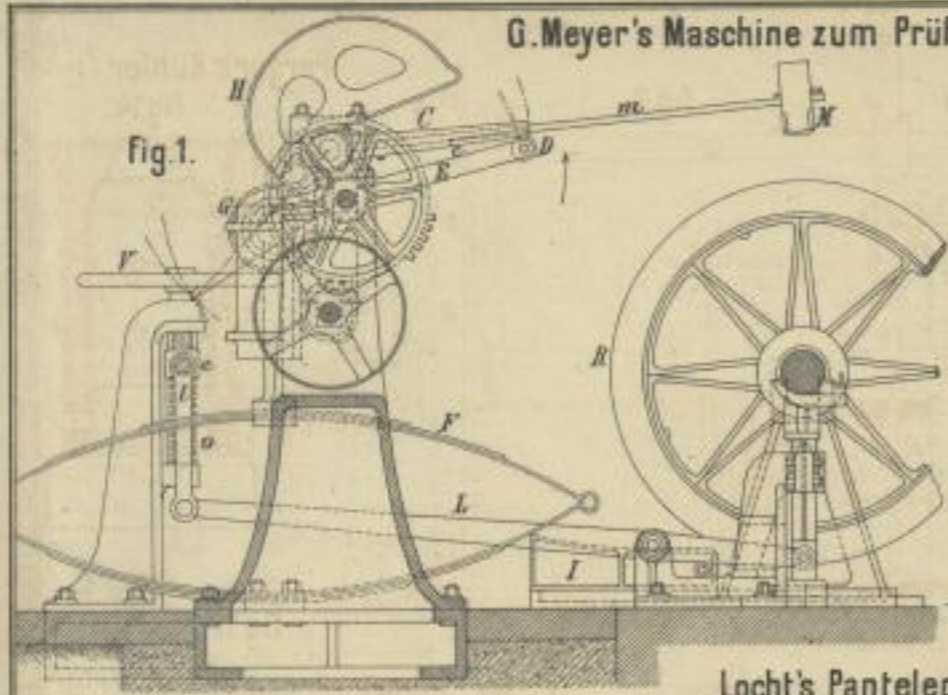

Perger's Kühler. (14)

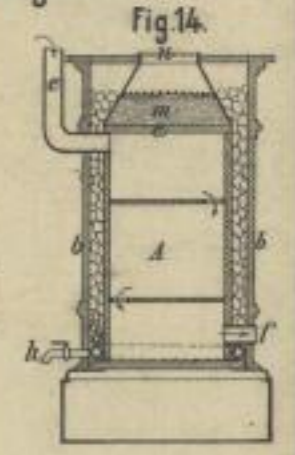

Locht's Pantelephon. (10-13)

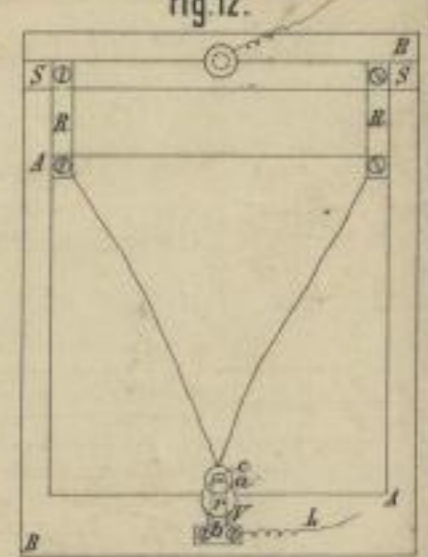
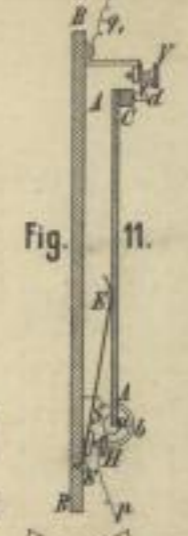
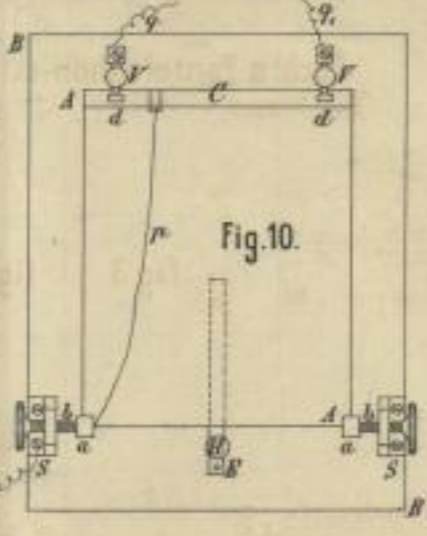
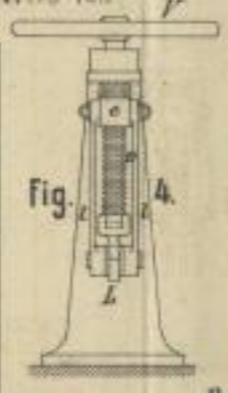
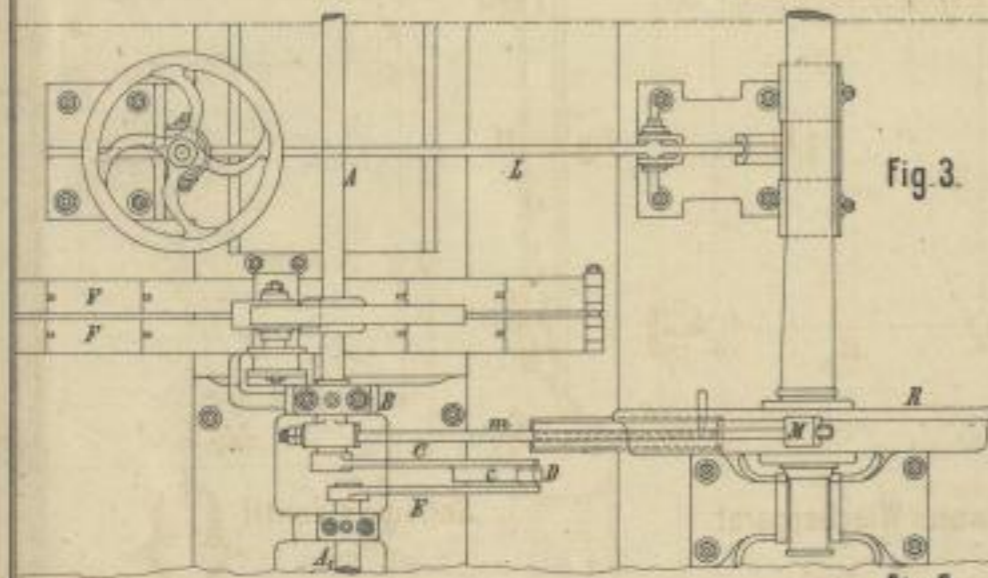

Rowan's Wiegeapparat. (8)

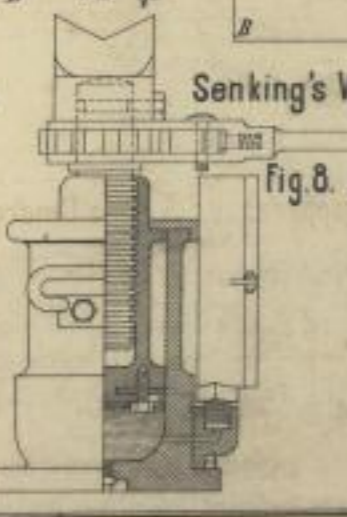
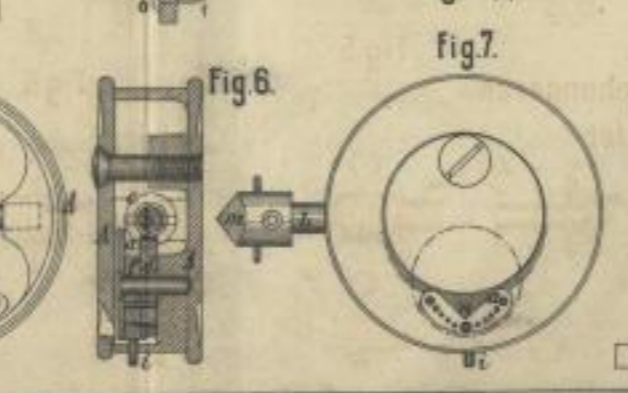

Senking's Ventil. (9)

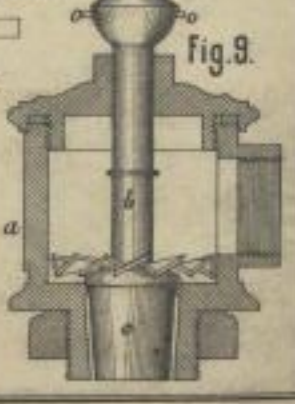

Knobel's Extractionsapparat. (15) S.&H's Umdrehungszähler. (5-7)

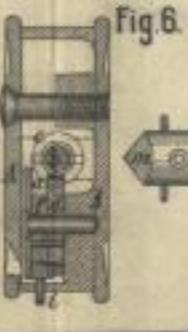
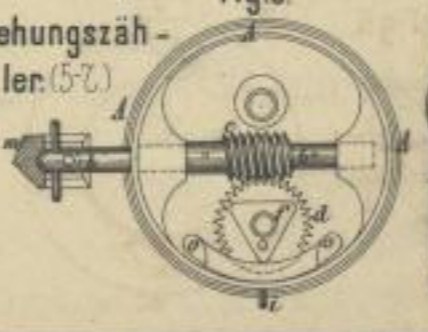
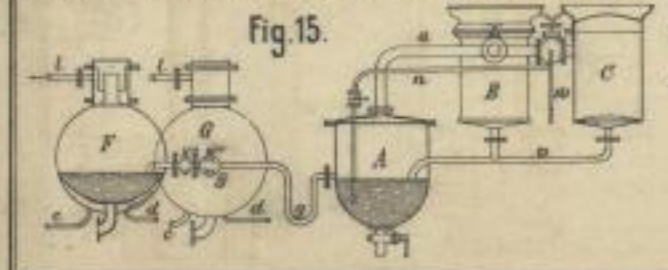

Verf. v. F. W. v. Jarmstadt



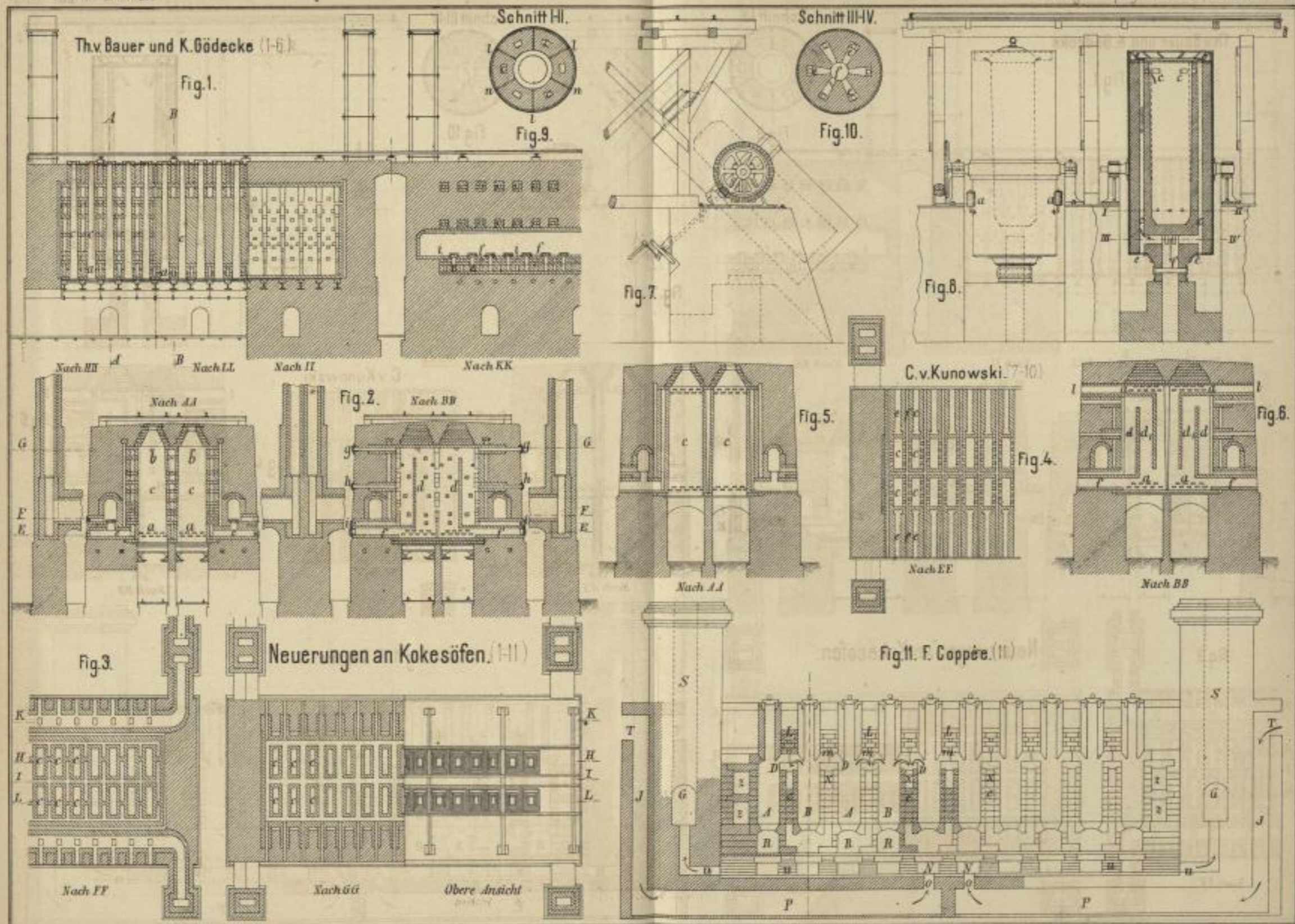

Lith. Anst. v. F. Wöhr. Darmstadt.



Sächs.  
bibl.  
1871

30211



















Wainzelmaier  
Buchbinder  
ERASSEN

Techn. A. 264.



SLUB DRESDEN



3 2422801