

























# Atlas

zu

## Dingler's polytechnisches Journal.

Band 235.

(Einundsechzigster Jahrgang.)

Jahrgang 1880.

---

Enthaltend 44 lithographirte Tafeln.



Augsburg.

Druck und Verlag der J. G. COTTA'schen Buchhandlung.

26717



Mengelberg's Steuerung.  
(1 u. 2)

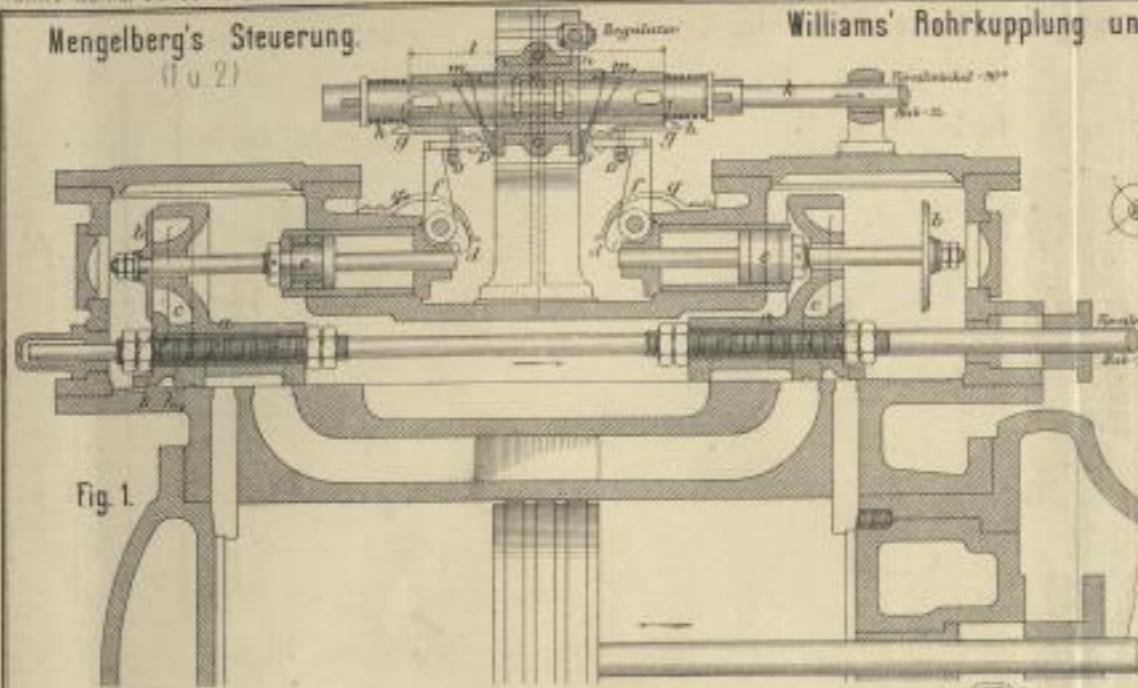

Fig. 1.

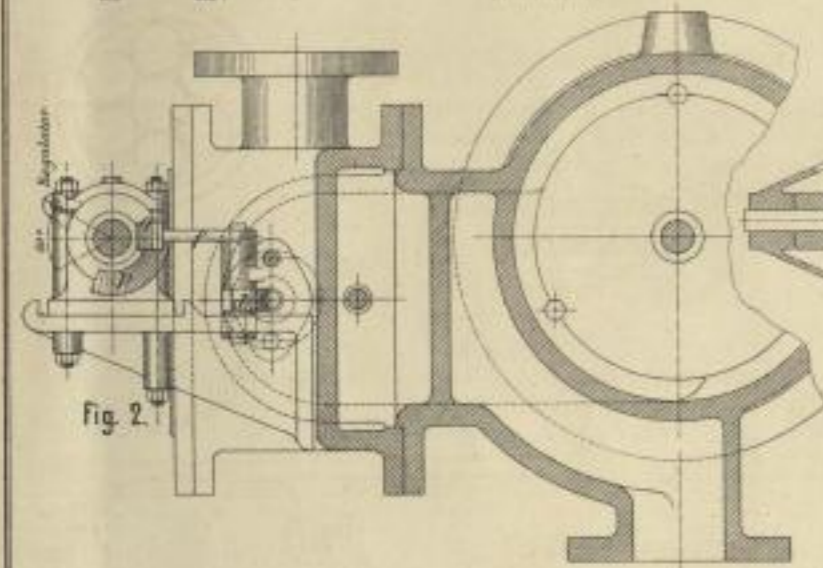

Fig. 2.

Williams' Rohrkuppung und Wasserableiter für Eisenbahnwagen. (6-11)



Fig. 3.



Fig. 8.

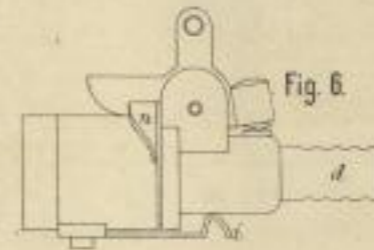

Fig. 6.

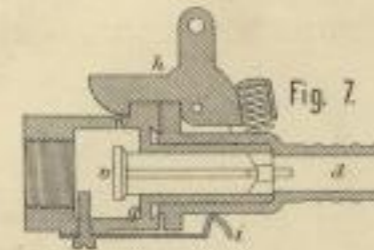

Fig. 7.

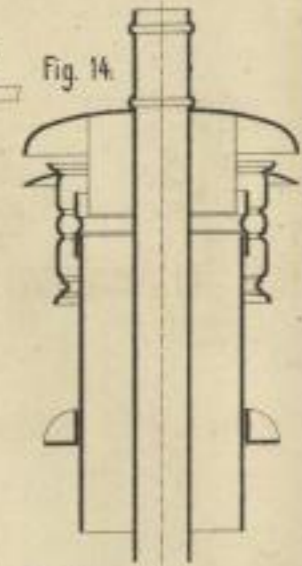

Fig. 14.

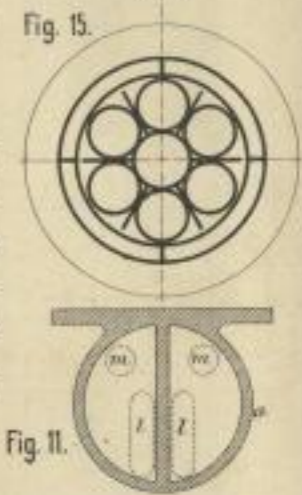

Fig. 15.

Knüttel's Regulator.  
(3-5)

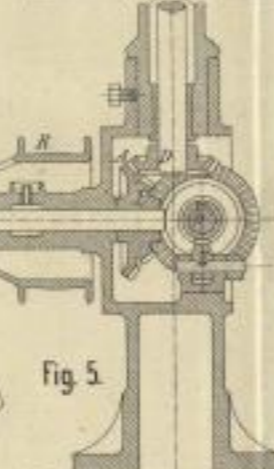

Fig. 5.

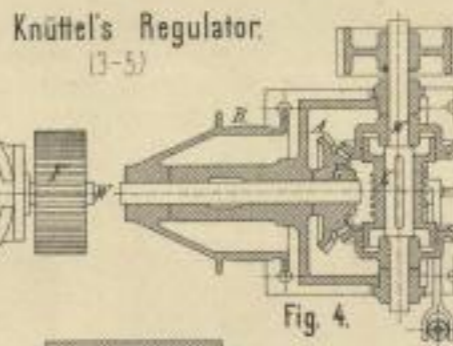

Fig. 4.

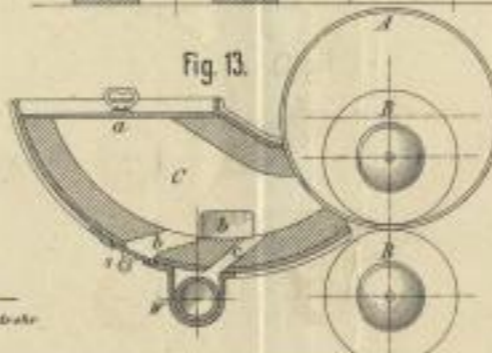

Fig. 13.

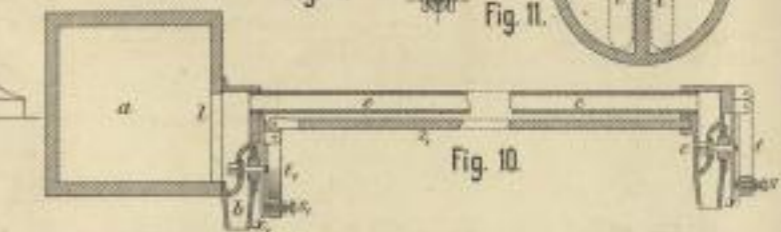

Fig. 10.

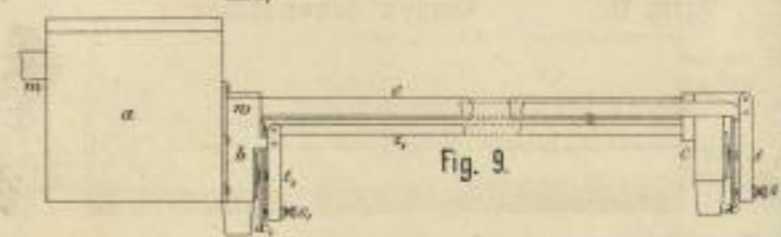
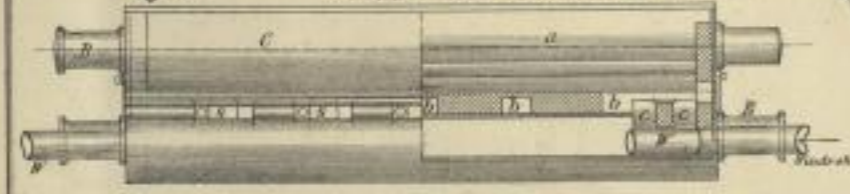

Fig. 9.

Fig. 12. Krupp's Schweissapparat. (12 u. 13)



100. Jost u. T. W. v. Bernstadt.







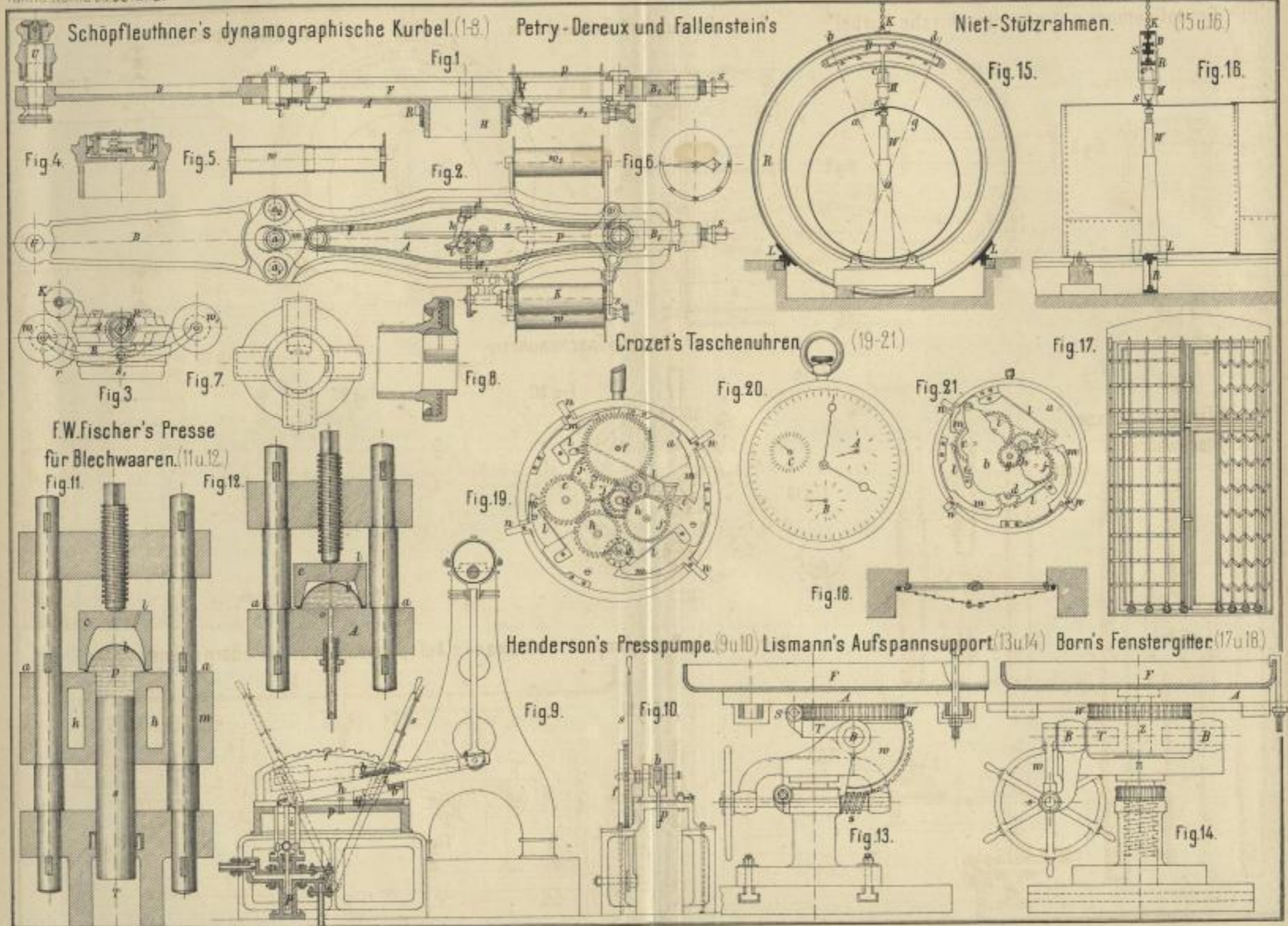

Isch. Anat. v. P. Wirtz, Darmstadt.



Neuerungen an Näh-

Maschinen. 10-25)

Gates' Webschütze. (1 u 2.)

Fig. 2.

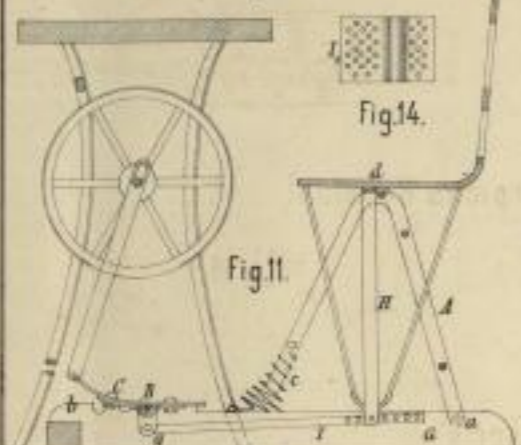

Fig. 11.

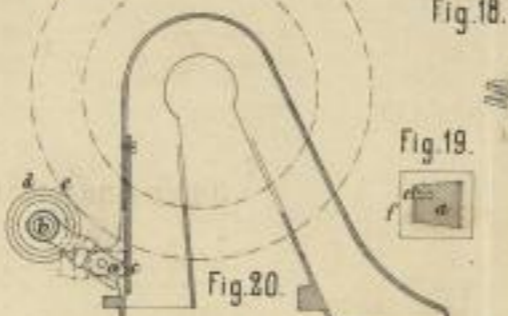

Fig. 20.

G. M. Pfaff. (20) W. P. Kraemer. (18 u 19)



Fig. 12.

Underwood und Smith. (11-14)

Fig. 13.

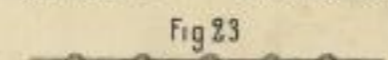

Fig. 23.

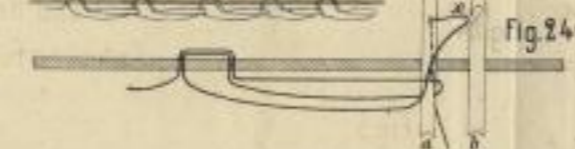

Fig. 24.



Fig. 25.

E. Wiesemann. (23-25)

Fig. 21.

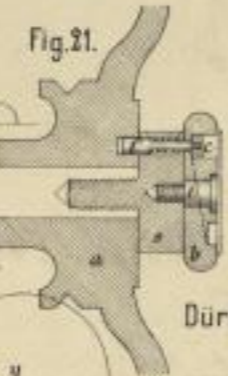

Fig. 22.



Dürkopp. (21 u 22)

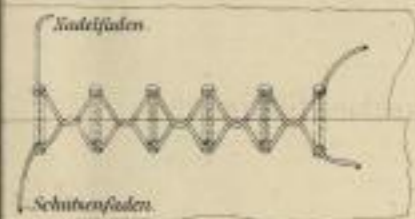

Fig. 15.

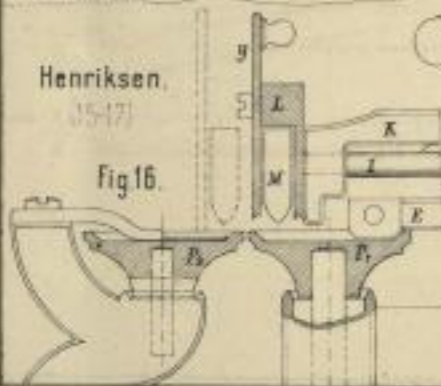

Fig. 16.

Henriksen. (15-17)



Fig. 17.

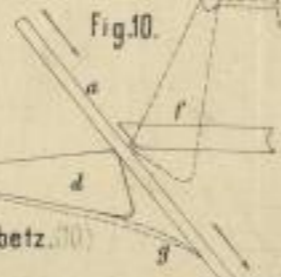
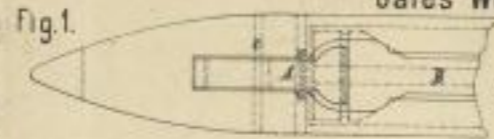

Fig. 10.

E. Schrabetz. (10)

Zelt. Druck v. J. Bock, Darmstadt.

Fig. 1.



Hahlo und Liebreich's Webstuhl. (5-7)



Fig. 5.

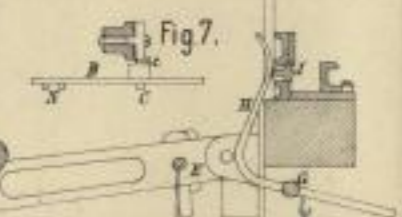

Fig. 7.

Thal und Beckert's Schaber für Webeblätter. (3 u 4)

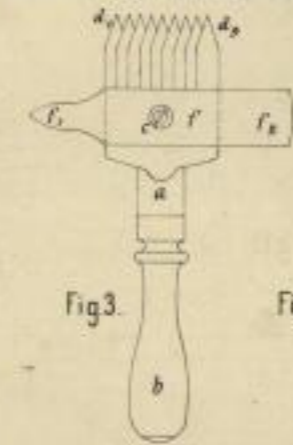

Fig. 3.



Fig. 4.

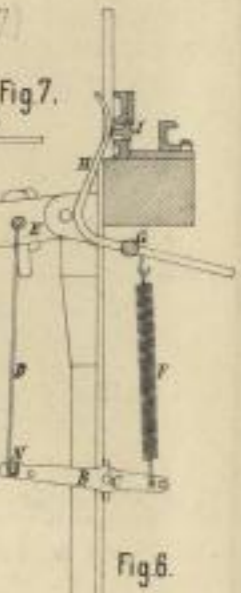

Fig. 6.

Krause und Mendel's Schneidmaschine für Gewebe. (8 u 9)

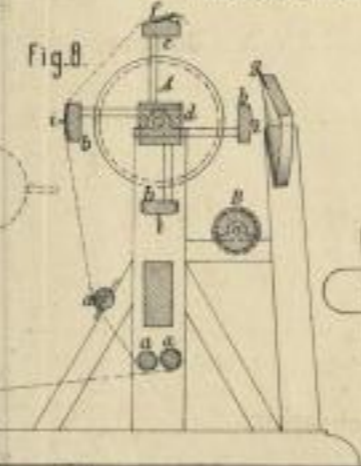

Fig. 8.

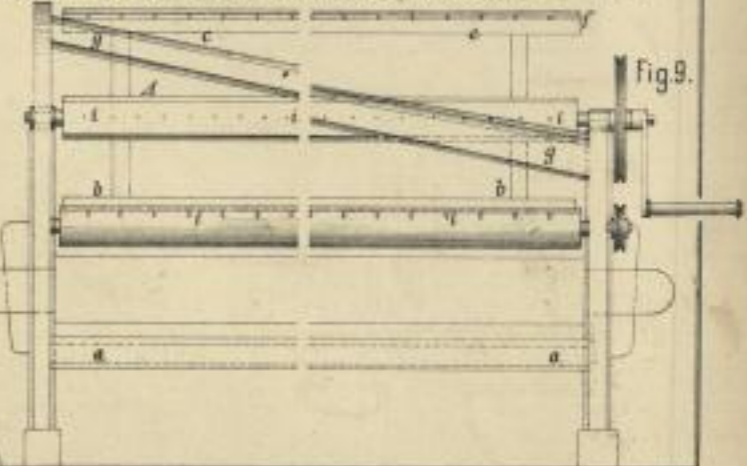
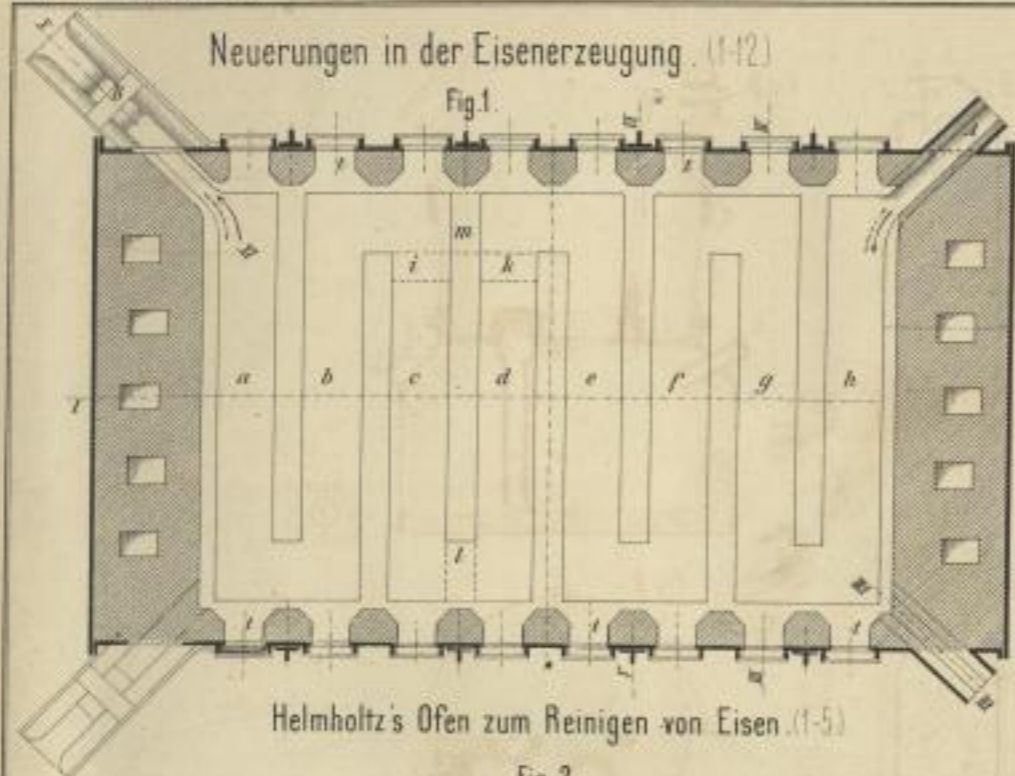

Fig. 9.



### Neuerungen in der Eisenerzeugung. (1-12)



### Helmholtz's Ofen zum Reinigen von Eisen. (1-5)

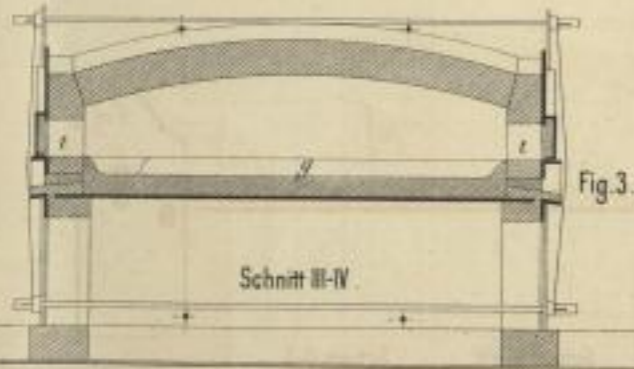
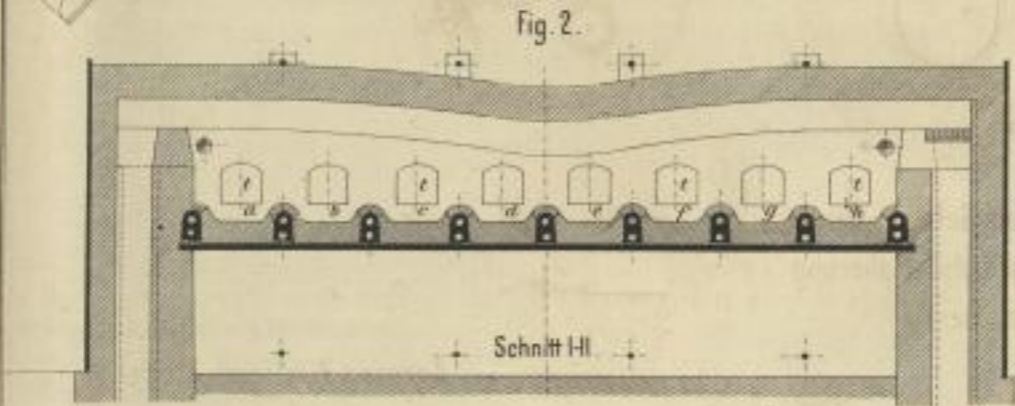

Schnitt III-IV

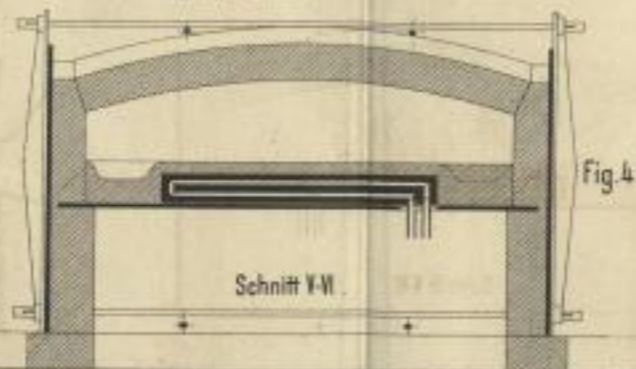

Schnitt V-VI

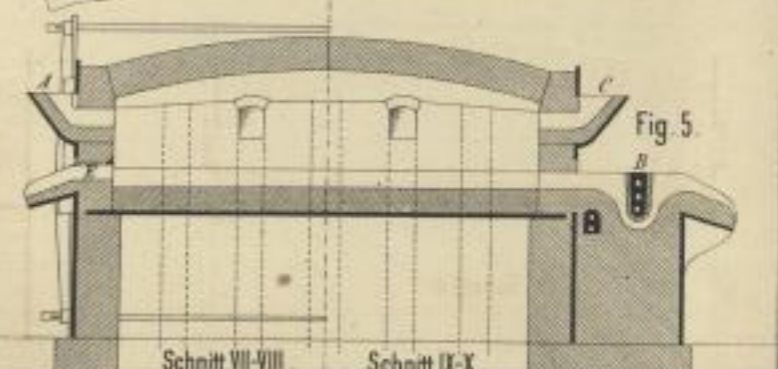

Schnitt VII-VIII

Schnitt IX-X

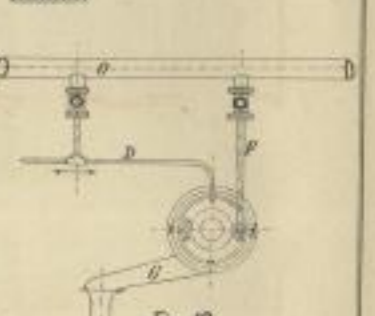
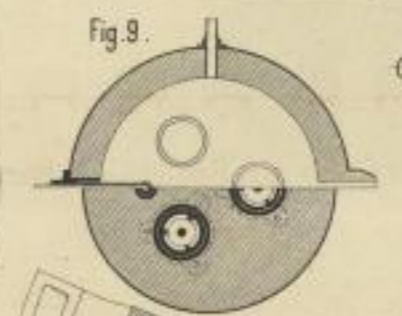
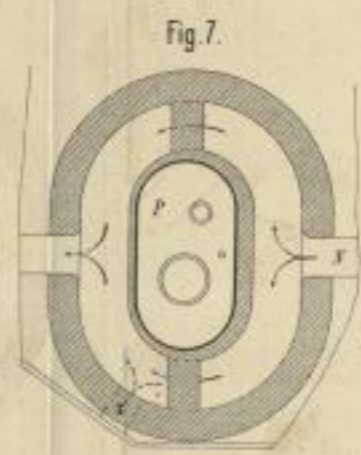
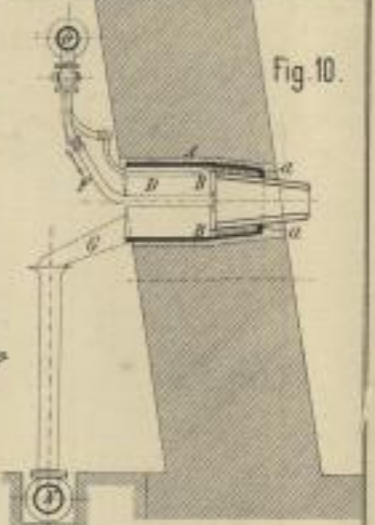
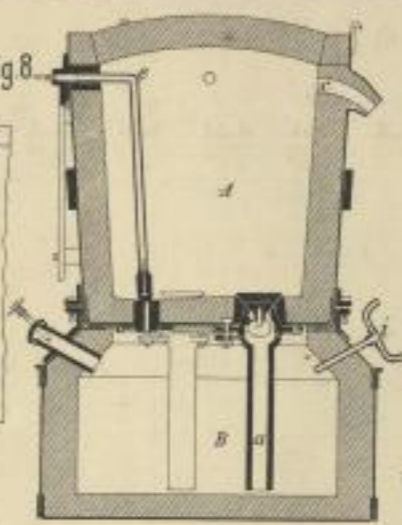
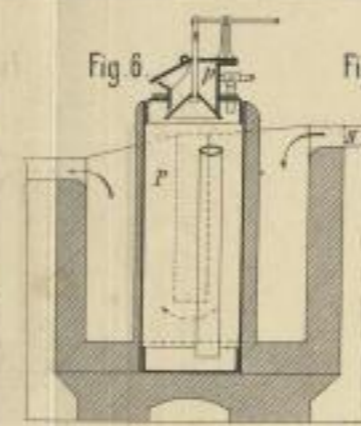

### Barnstorf und Schulze-Berge's Apparate zur Entphosphorung des Eisens. (6-9)

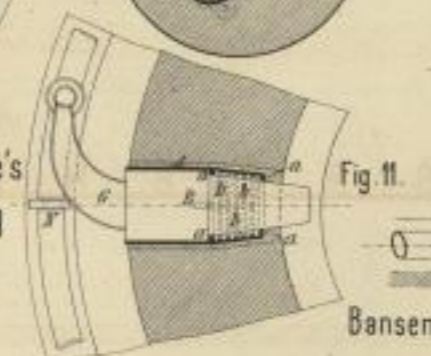

### Bansen's Windform-Mantel (10-12)

Zu A. Aus. v. F. Wess. Darmstadt



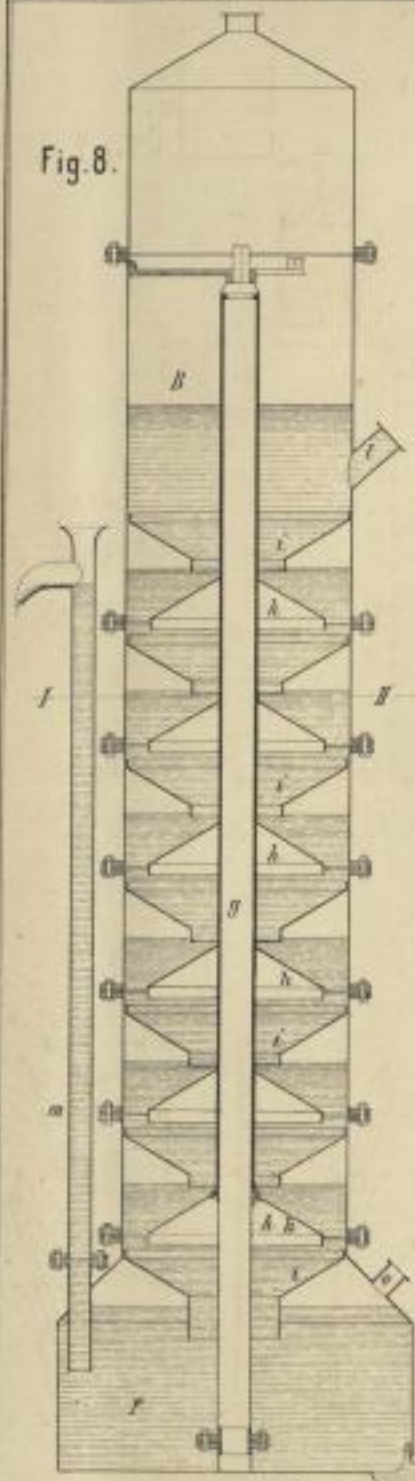

Fig. 8.

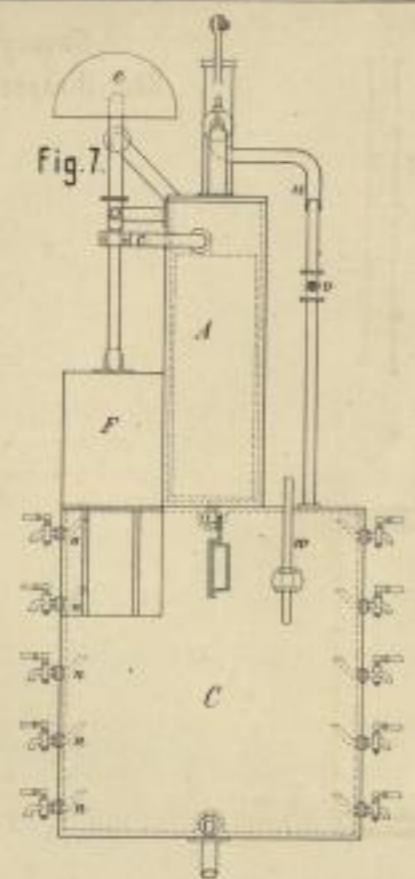

Fig. 7.

Wagner und Ballerstedt's  
Reinigungs- und Controllapparat.  
(5-7)

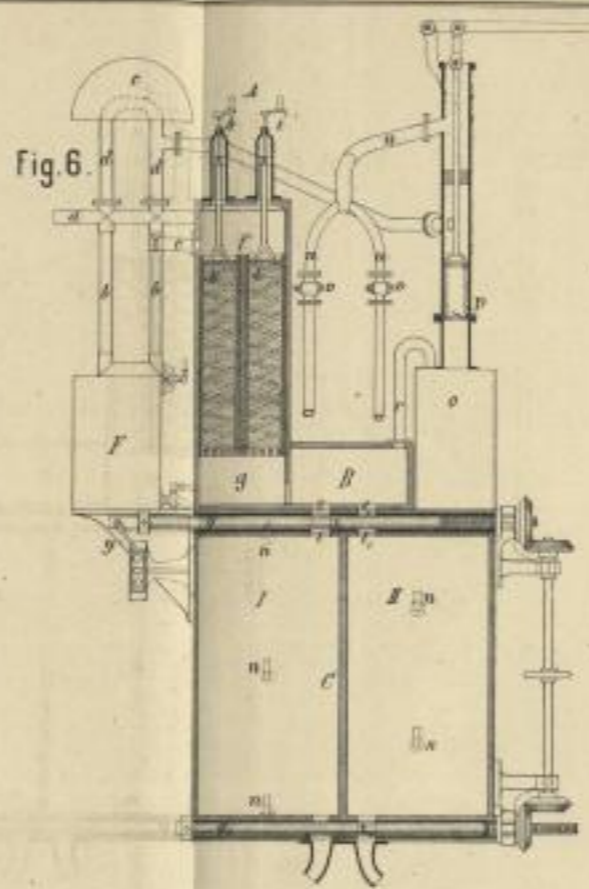

Fig. 6.

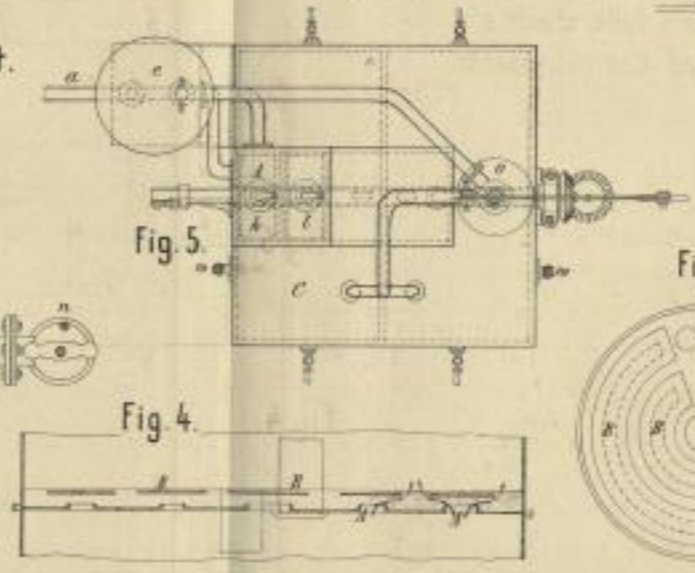

Fig. 5.

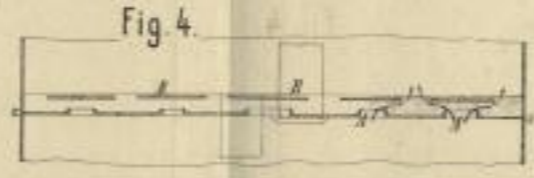

Fig. 4.



Fig. 3.

Engelke's Entlutterungscolonne. (1)

Savary's  
Destillirapparat. (2-4)

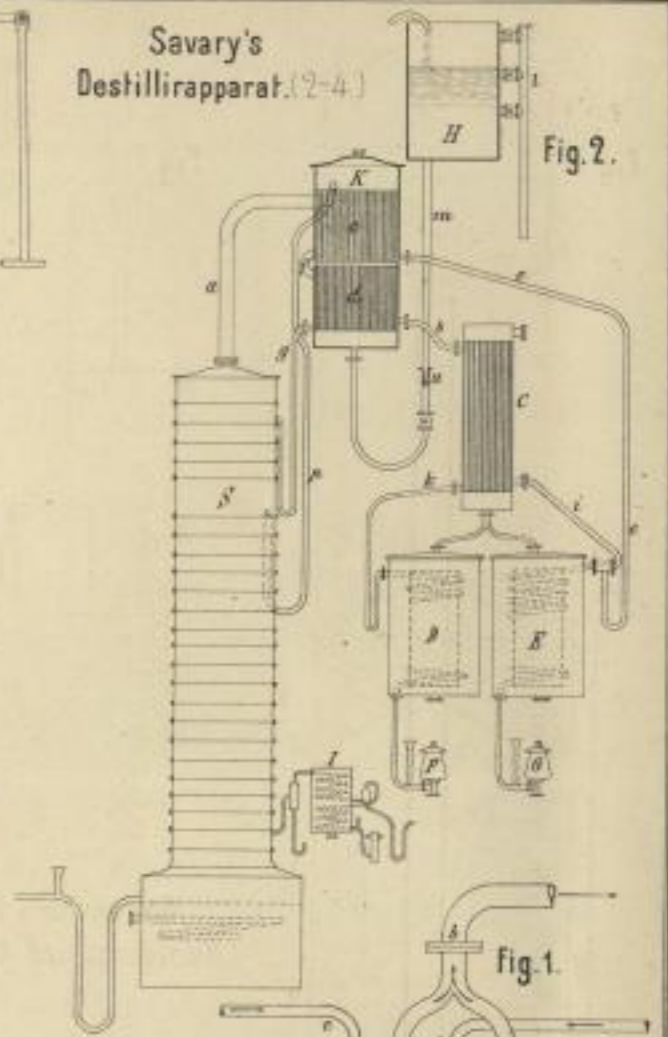

Fig. 2.

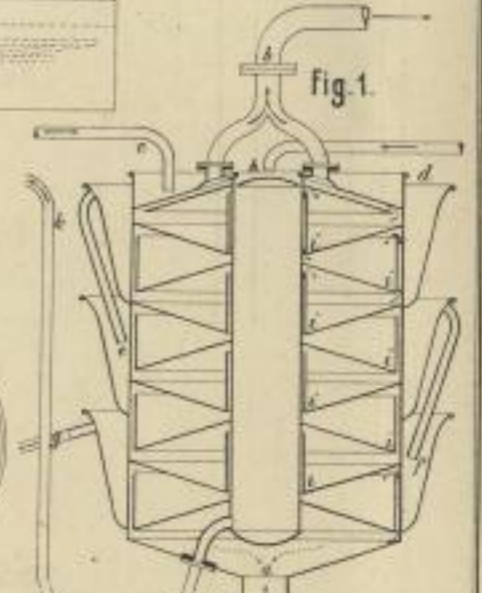

Fig. 1.

Neuerungen in der Spiritusfabrikation. (1-9)



### M. Weinrich's Elutionsverfahren (1-4) Fabrikanlage für eine tägliche Verarbeitung von 18000<sup>h</sup> Melasse.

Fig. 1.

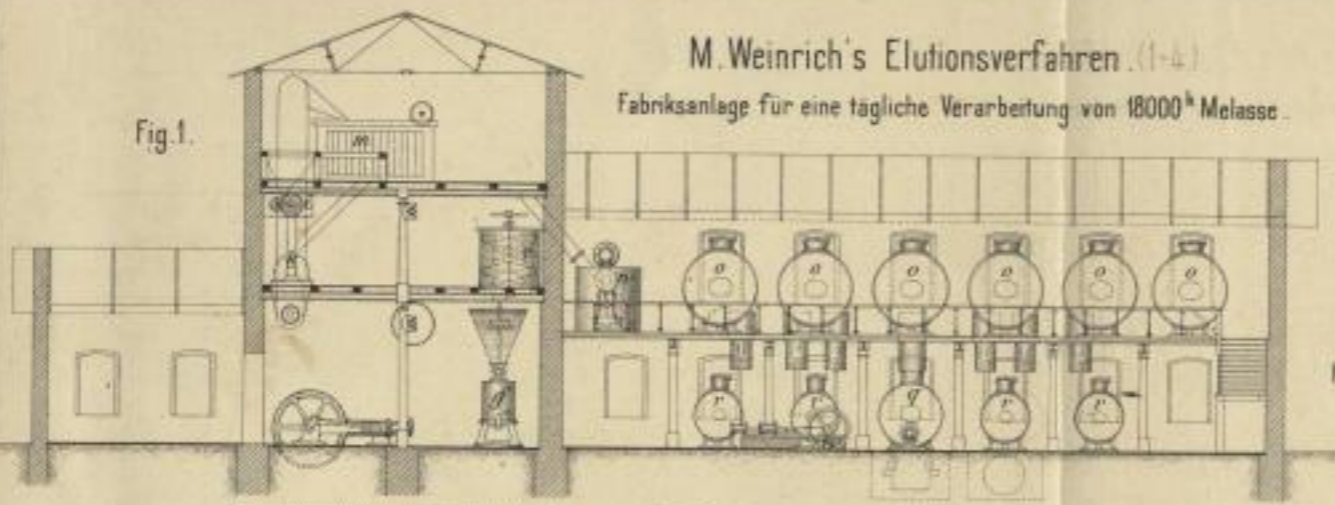

Fig. 2.

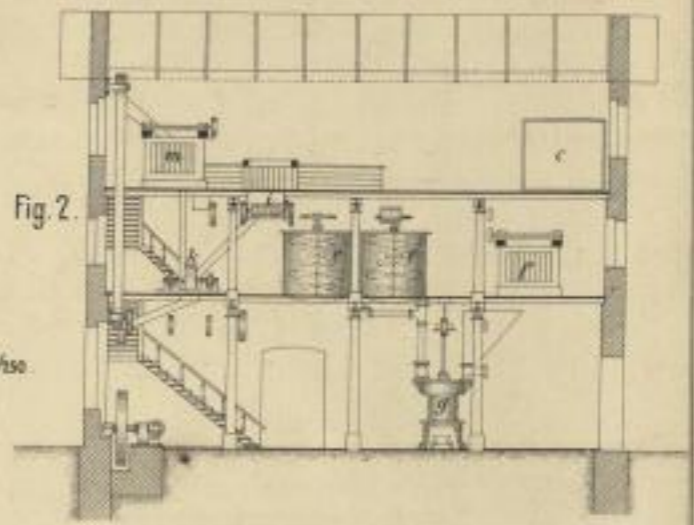

Fig. 3.

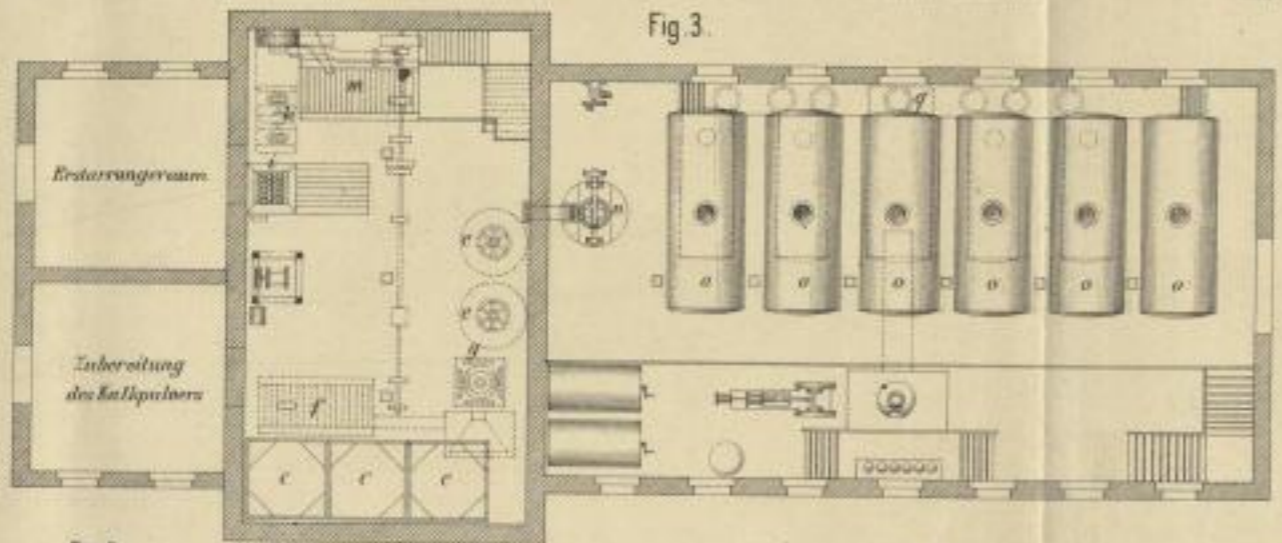
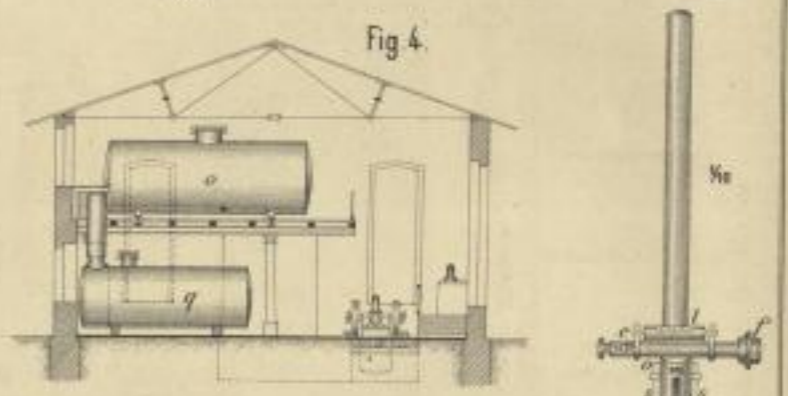

Fig. 4.



Mittel gegen Siedeverzug

Fig. 5.

Fig. 6.

Fig. 7.

Fig. 8.

Fig. 9.

Fig. 12.

Fig. 11.

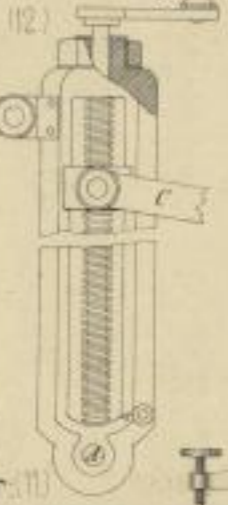
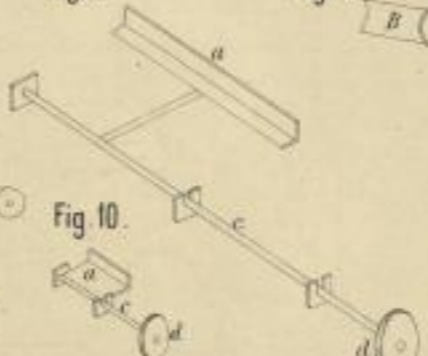
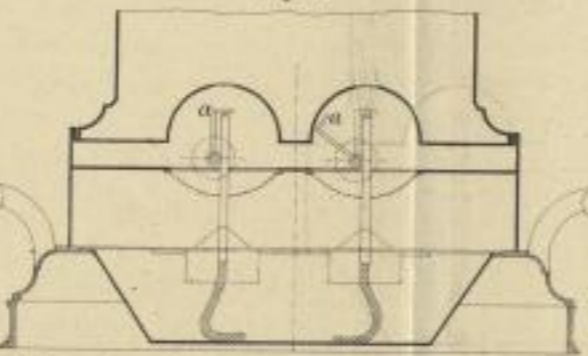
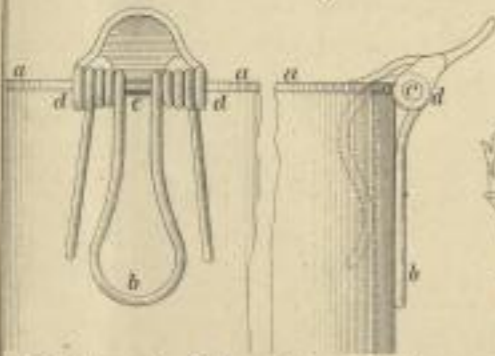

Stadelmann's Gefäßdeckel (5 u. 6)

Weigelt's Löscher für Erdöllampen (7-10)

F. Miller's Ablesefernrohr (11)

*Entw. von F. Weinrich*



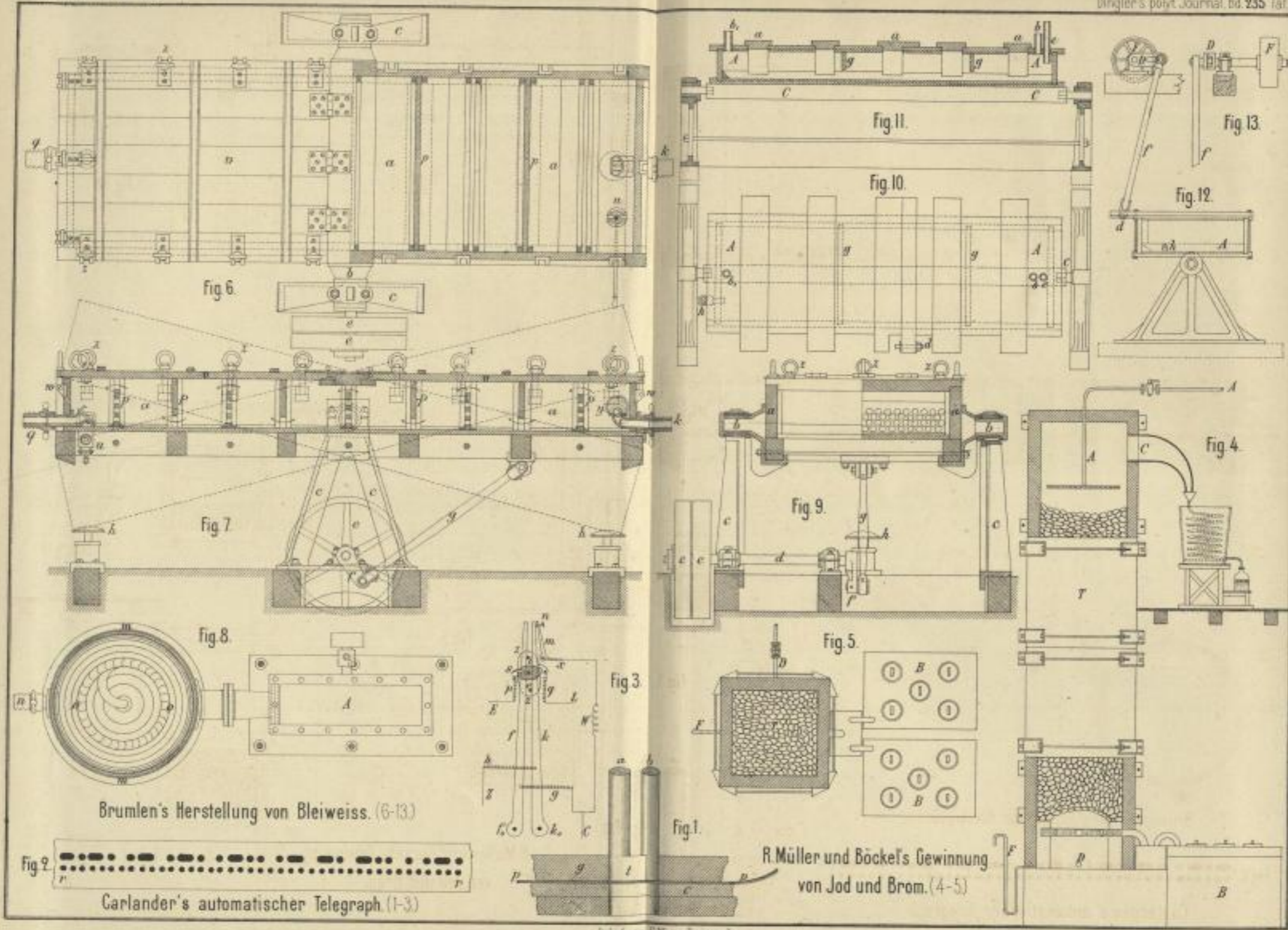

Brumlen's Herstellung von Bleiweiss. (6-13.)

Fig. 2. Carlander's automatischer Telegraph (1-3.)

R. Müller und Böckel's Gewinnung von Jod und Brom. (4-5)

*Arch. d. Wiss. u. Kunst.*



### Ehrhardt und Sehmer's Schleppschieber-Steuerung. (I-III)

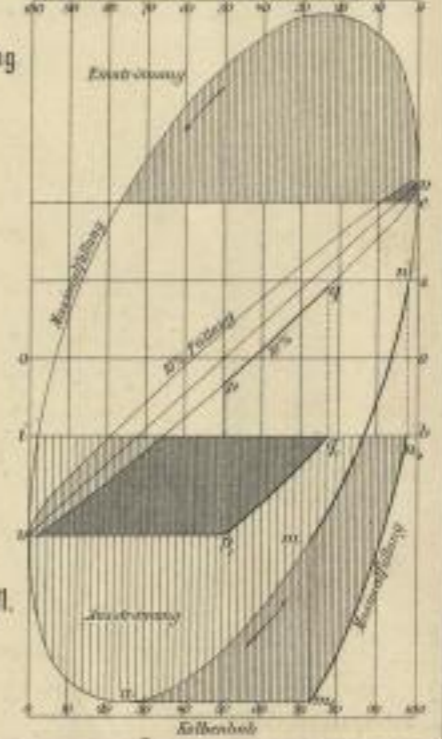
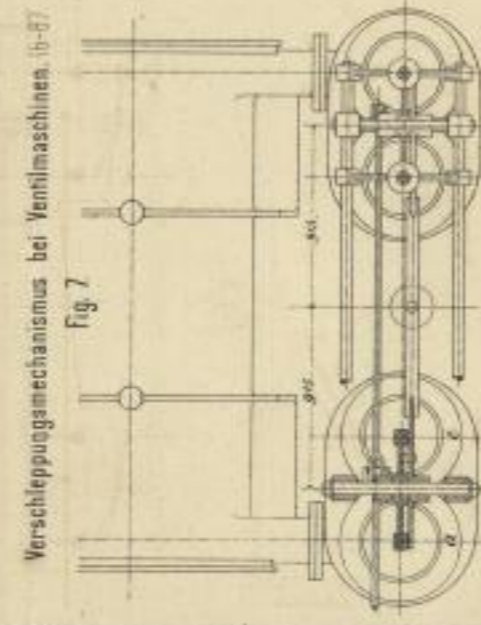
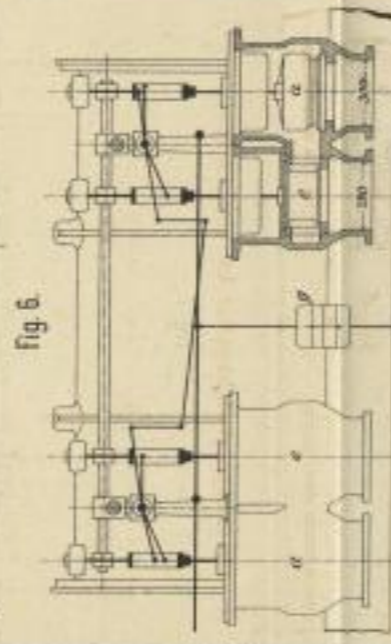
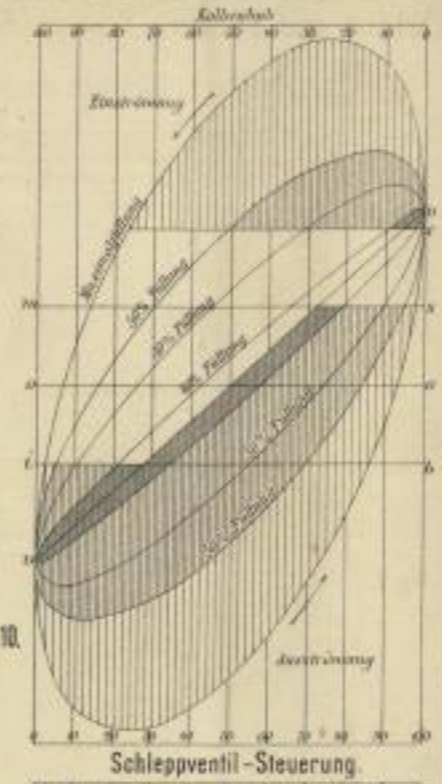
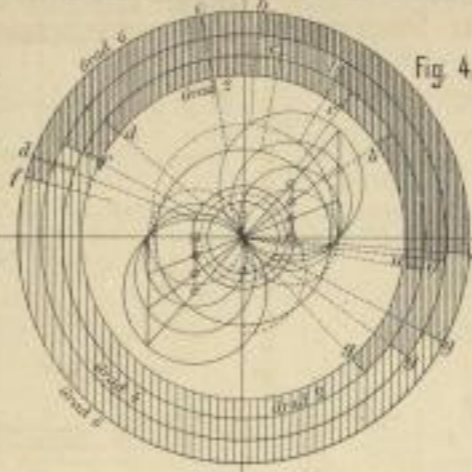
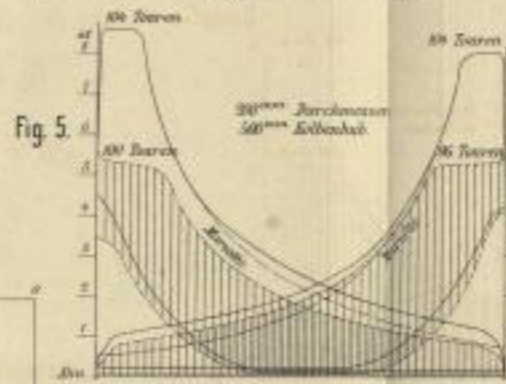
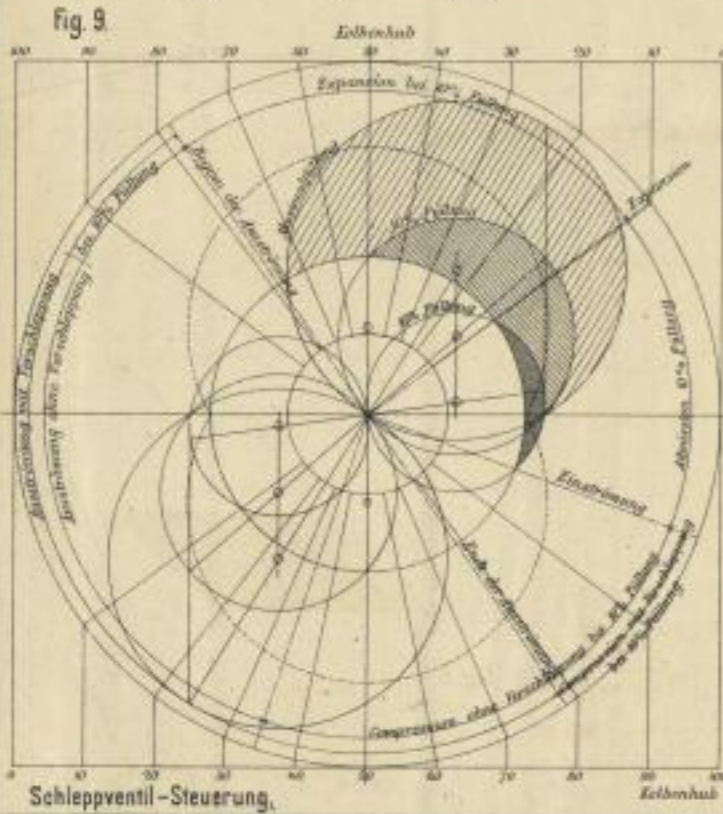
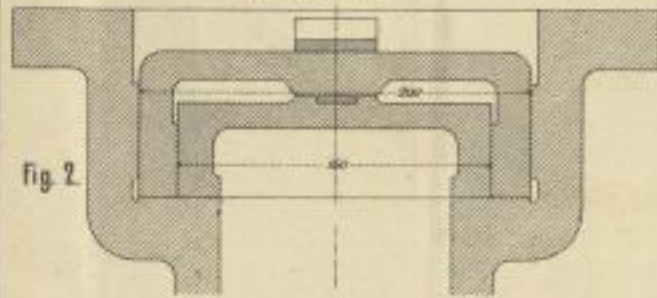
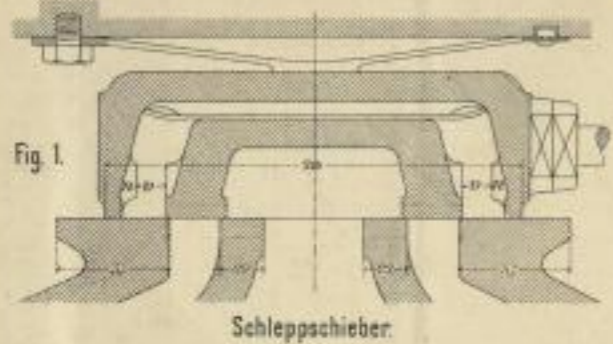

Lith. Anst. v. F. Frits, Darmstadt





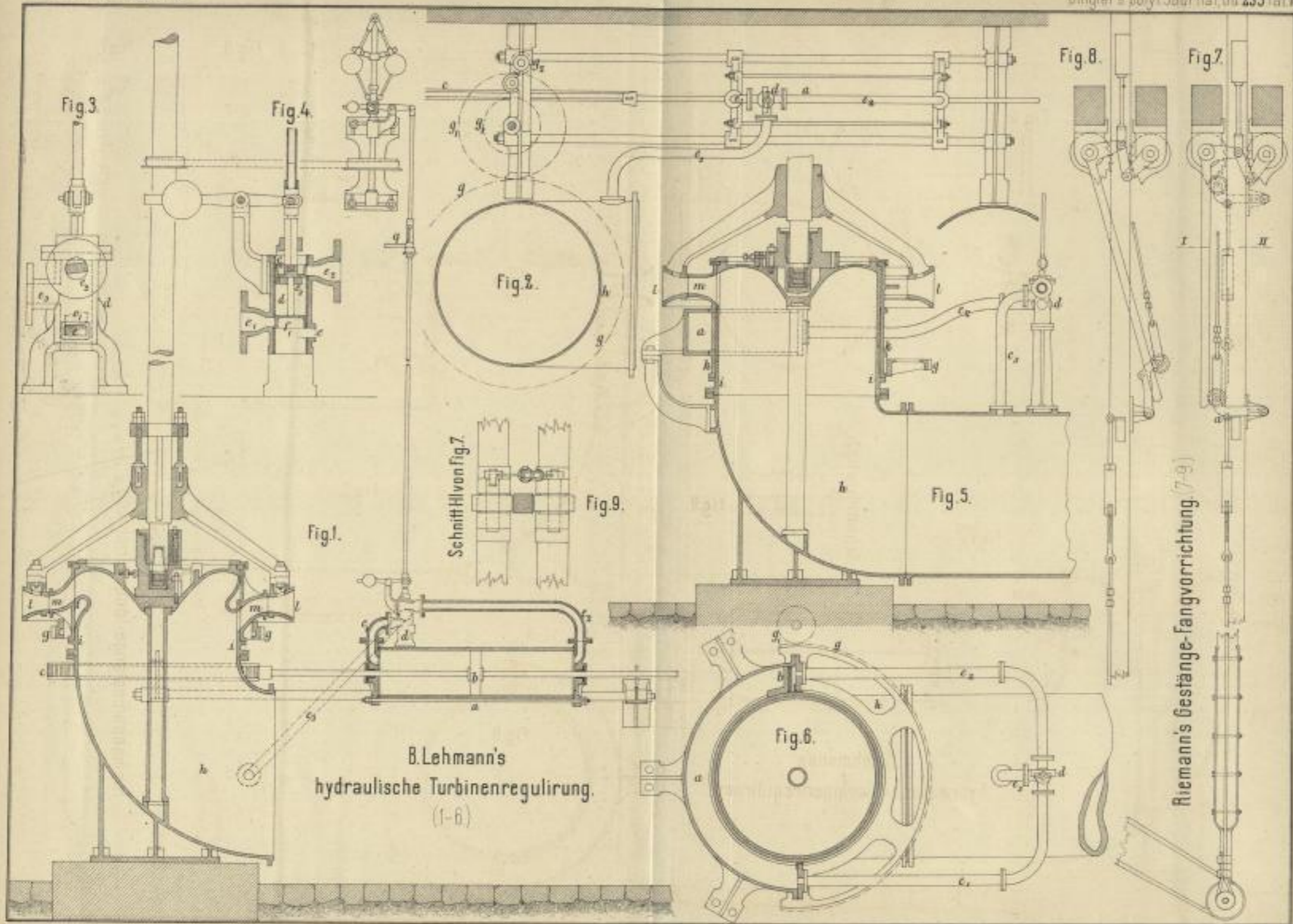

Lith. Anst. v. F. W. Hofe Darmstadt.



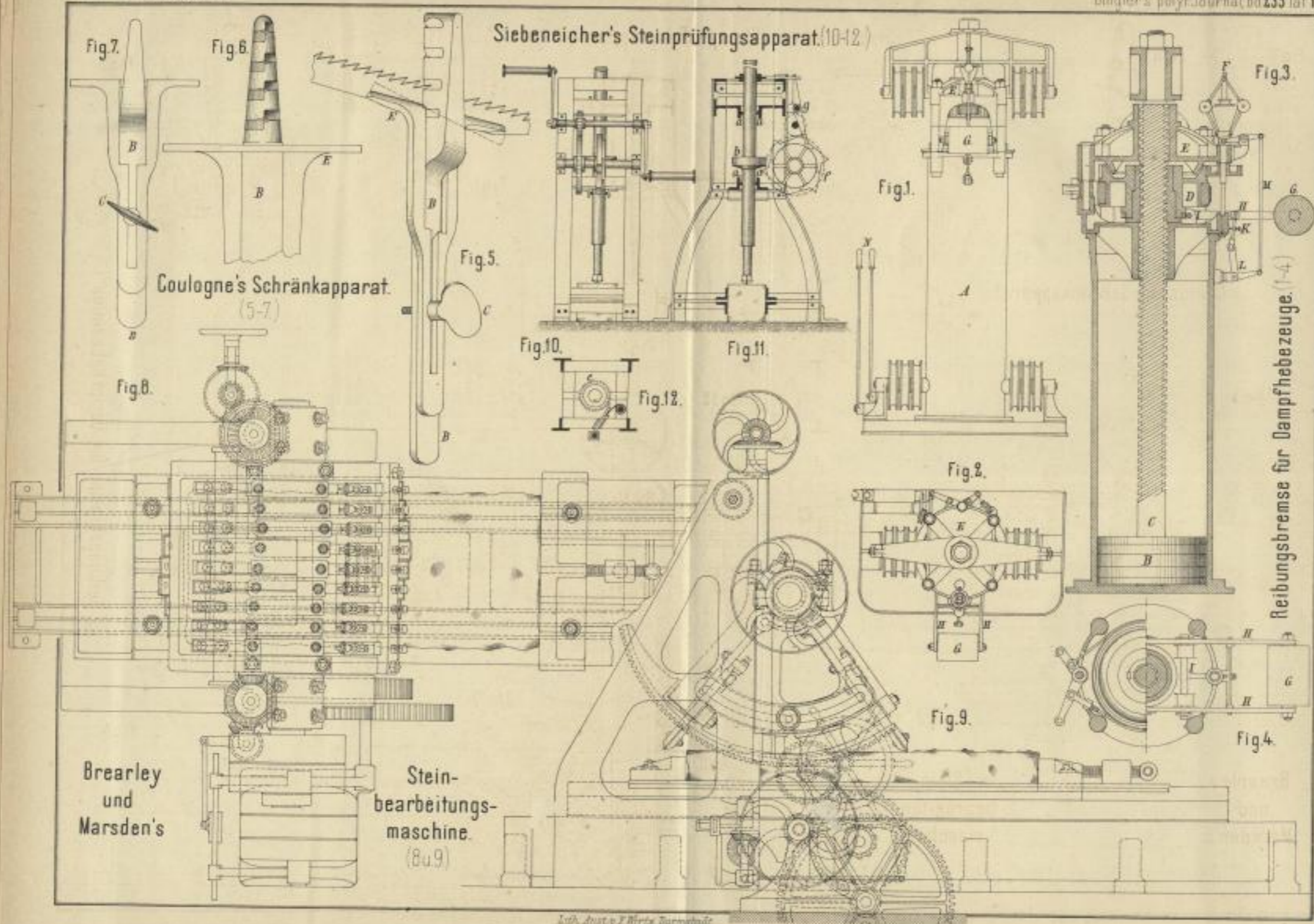

Zth. Anst. v. F. Wirtz, Darmstadt



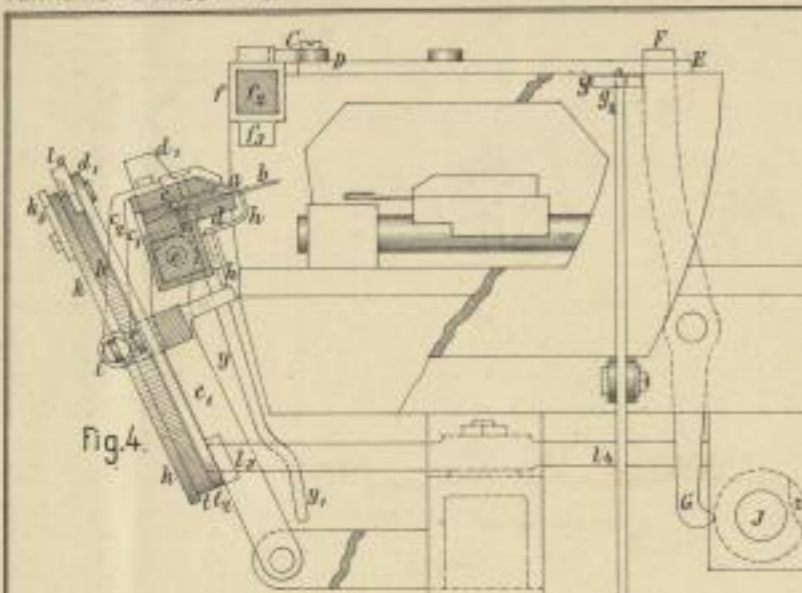

Fig. 4.

Mossig's Wirkstuhl. (4-6)

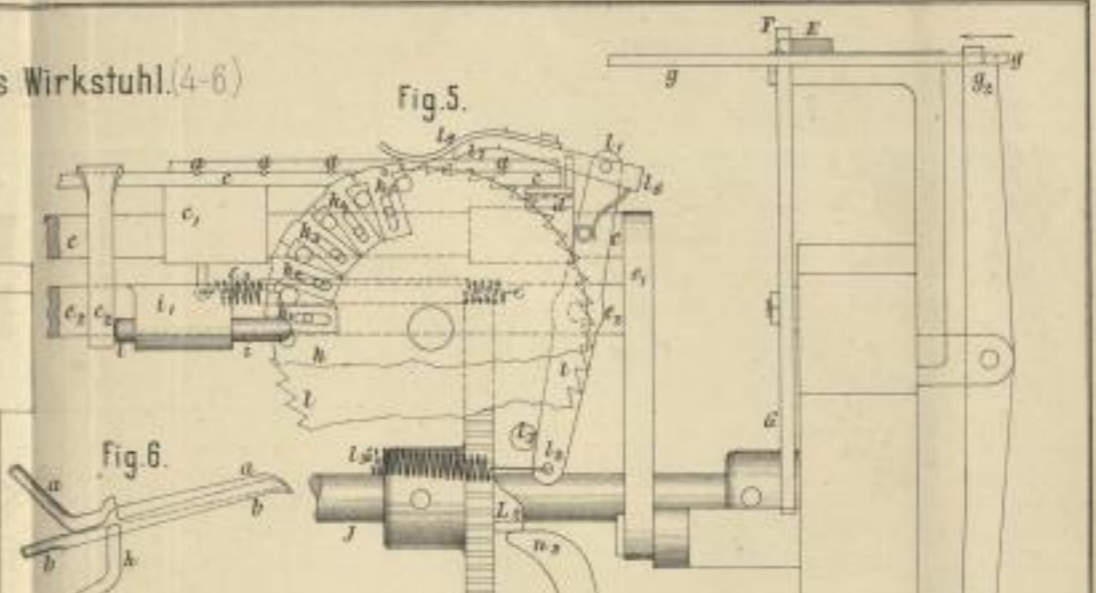

Fig. 5.

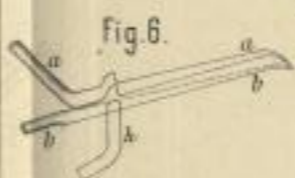

Fig. 6.

Quast's Regulator. (1 u 2.)

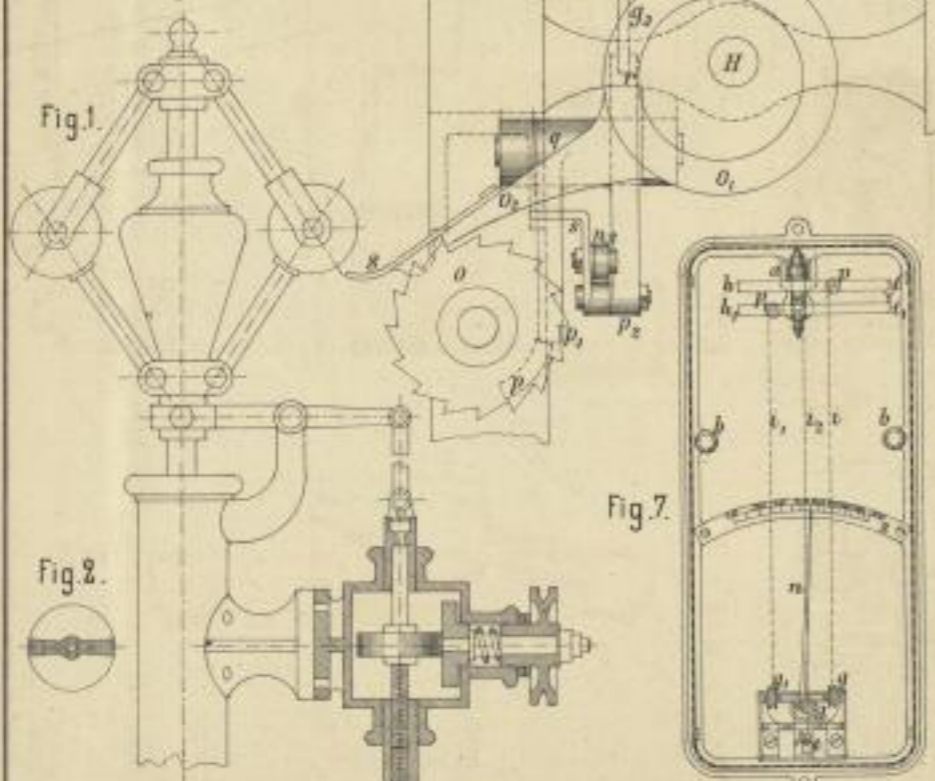

Fig. 1.

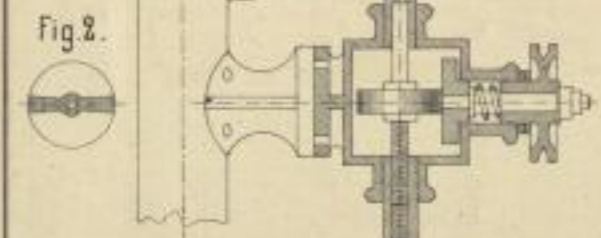

Fig. 2.

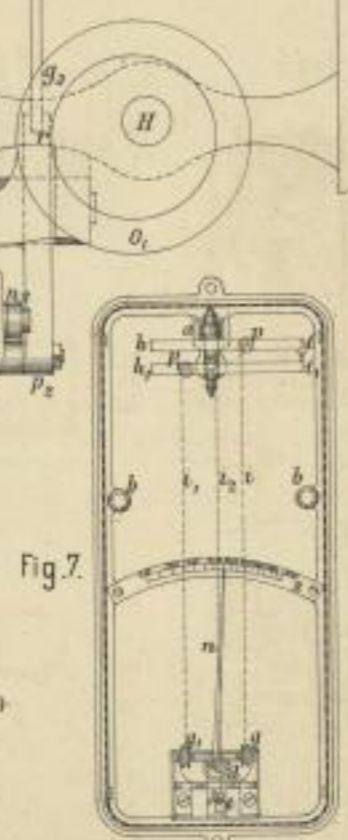

Fig. 7.

Rietschel und Hennebergs Luftbefeuchtungsapparat. (7-11)

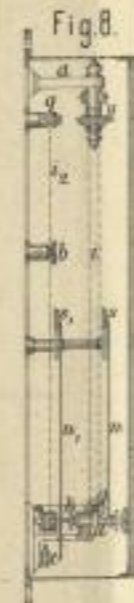

Fig. 8.

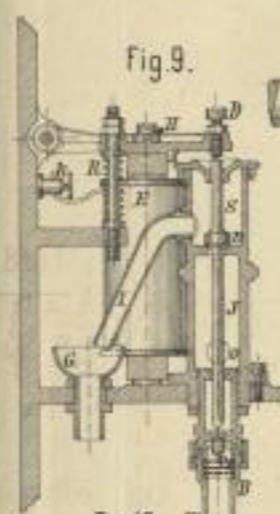

Fig. 9.

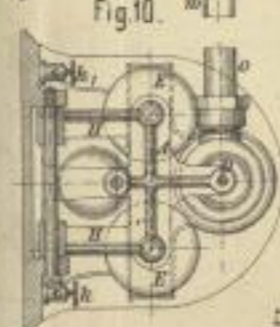

Fig. 10.

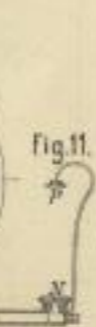

Fig. 11.

Fleck's Nuthobelmaschine. (3)

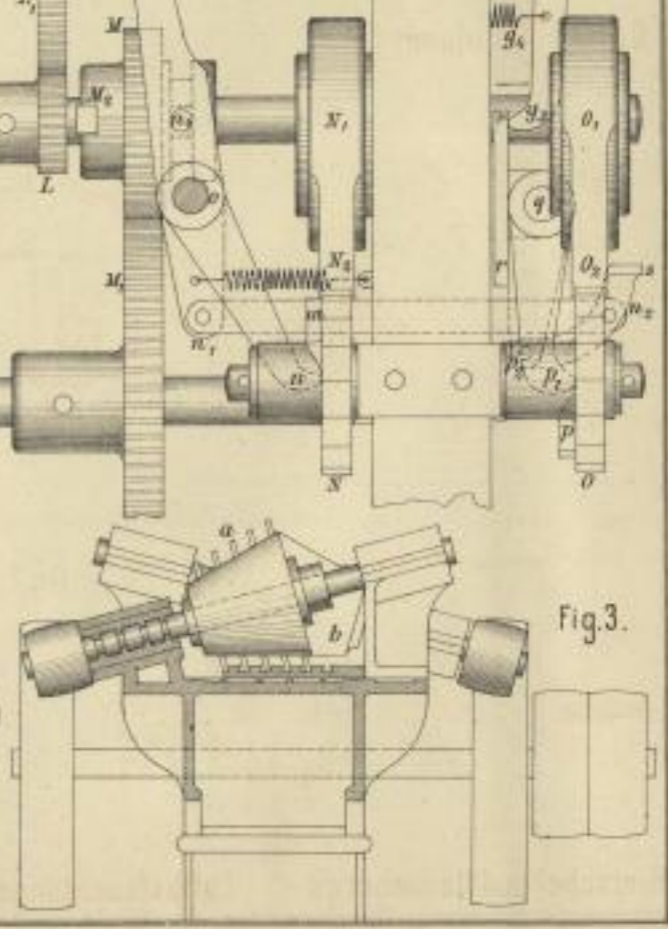

Fig. 3.

Lith. Anst. v. J. W. Neumann, Neudamm.



Servais und Feltgen's Ofen zur Reinigung des Roheisens. (1-6)

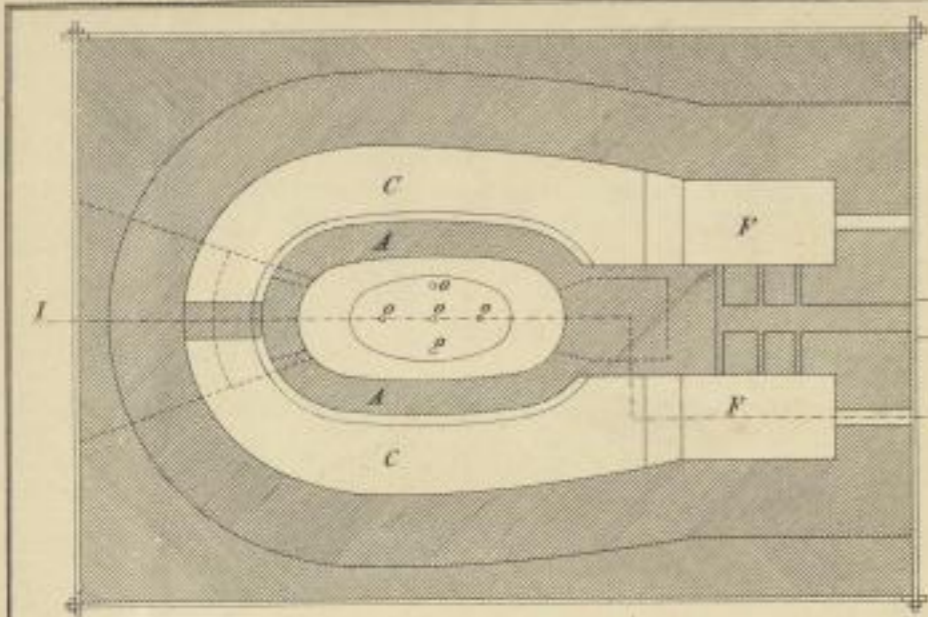
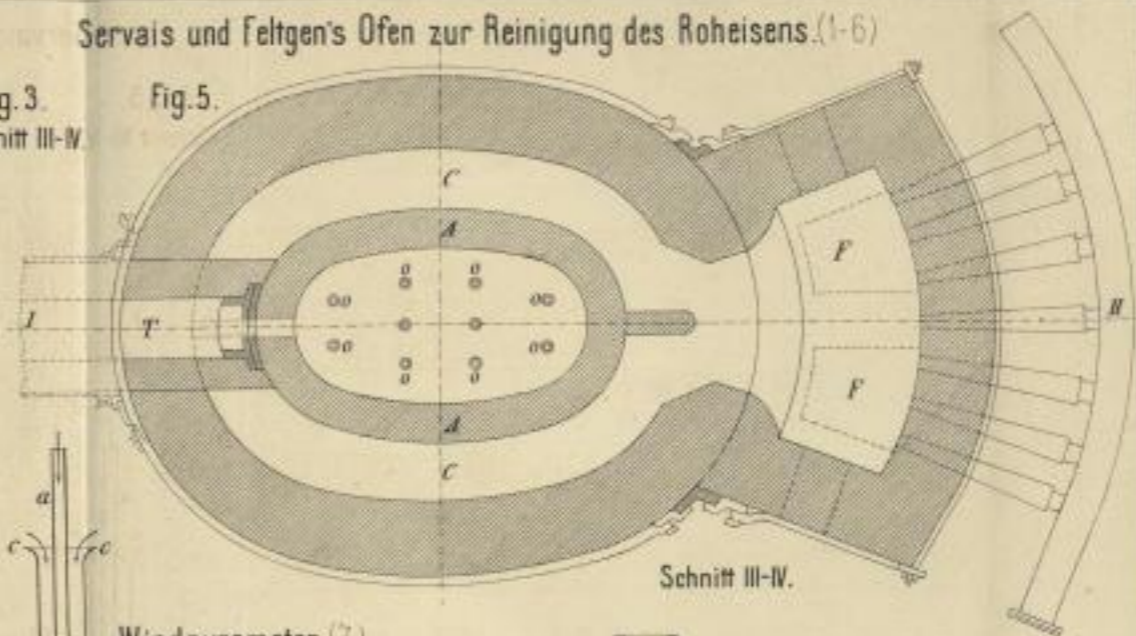

Fig. 3. Schnitt III-IV.



Schnitt III-IV.

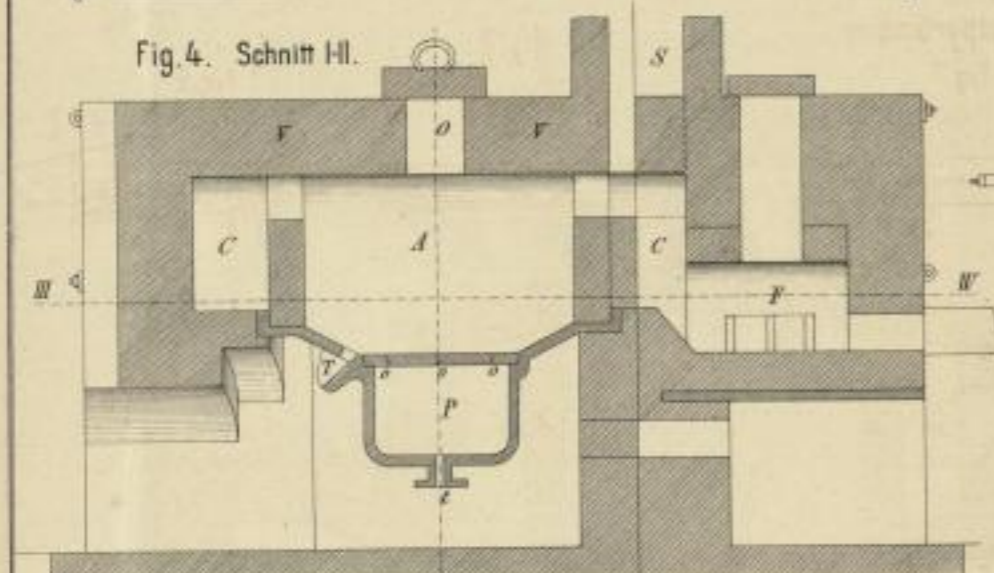
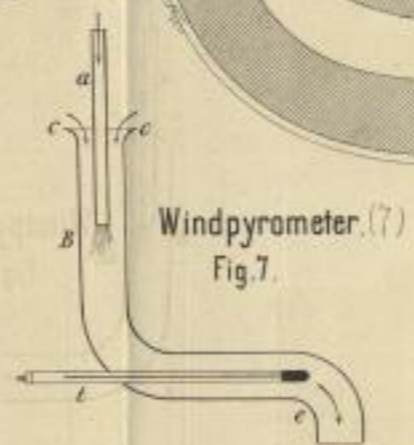

Fig. 4. Schnitt III.



Windpyrometer. (7) Fig. 7.



Fig. 1.

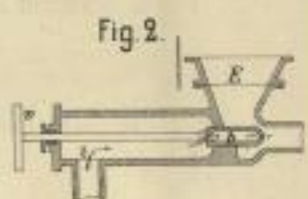

Fig. 2.

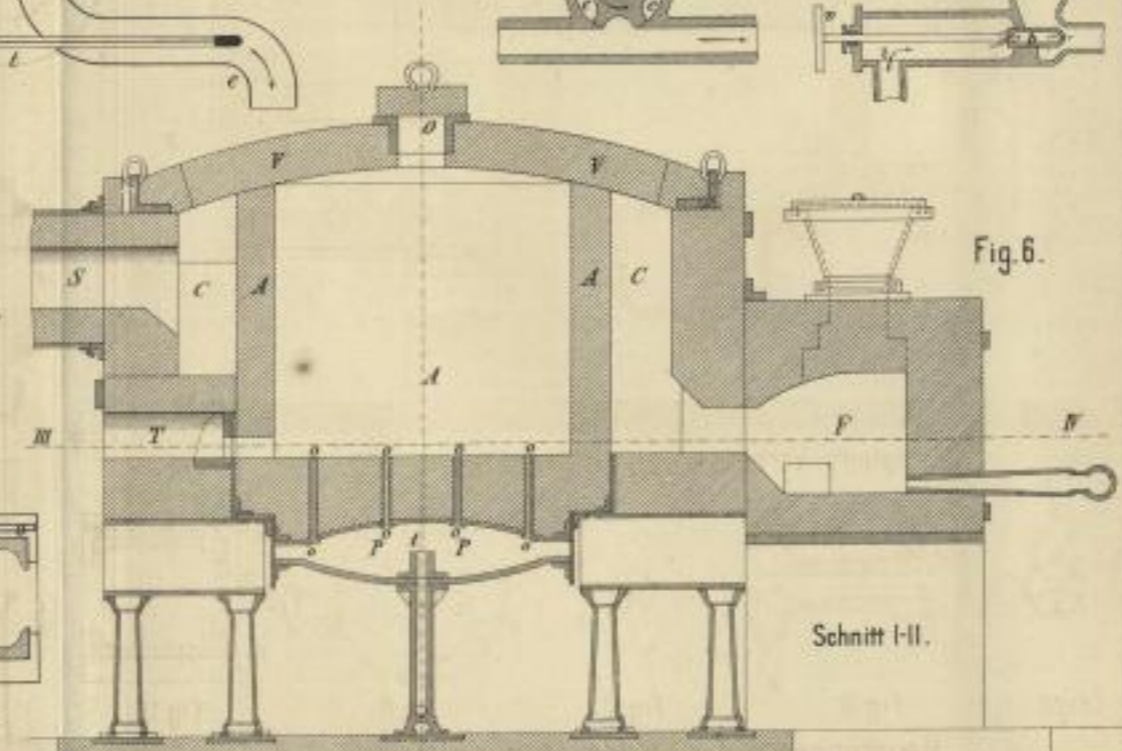

Fig. 6.

Schnitt I-II.

Crampton's Verbesserung an Drehöfen. (8-12)

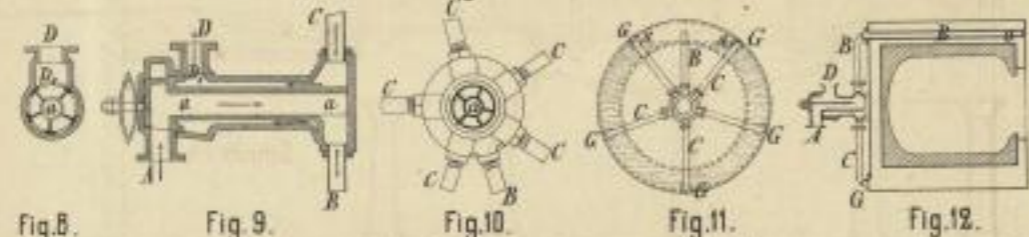

Fig. 8.

Fig. 9.

Fig. 10.

Fig. 11.

Fig. 12.

Neuerungen in der Eisenerzeugung. (1-12)

Tsch. Anstalt v. P. W. v. P. v. P.





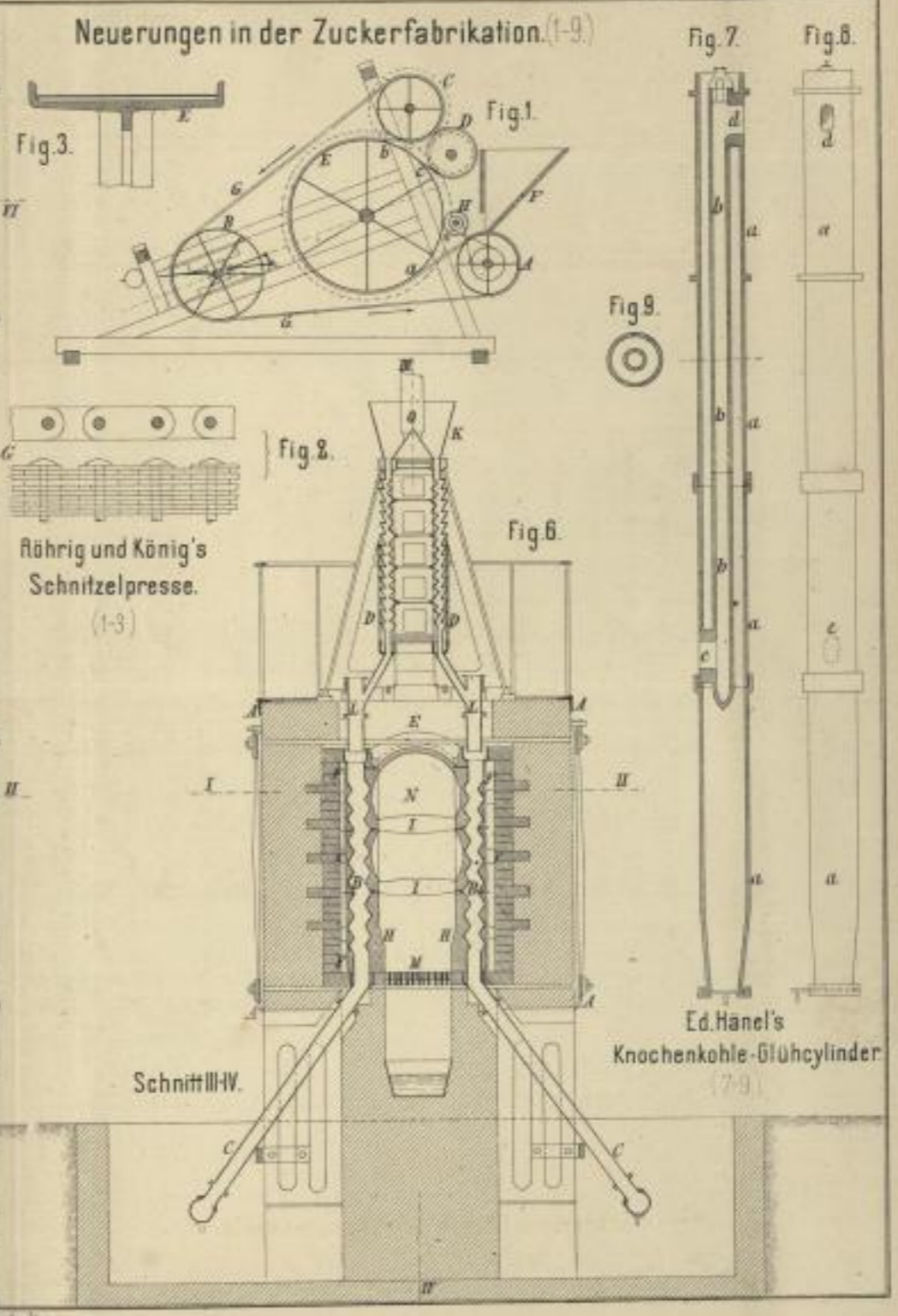
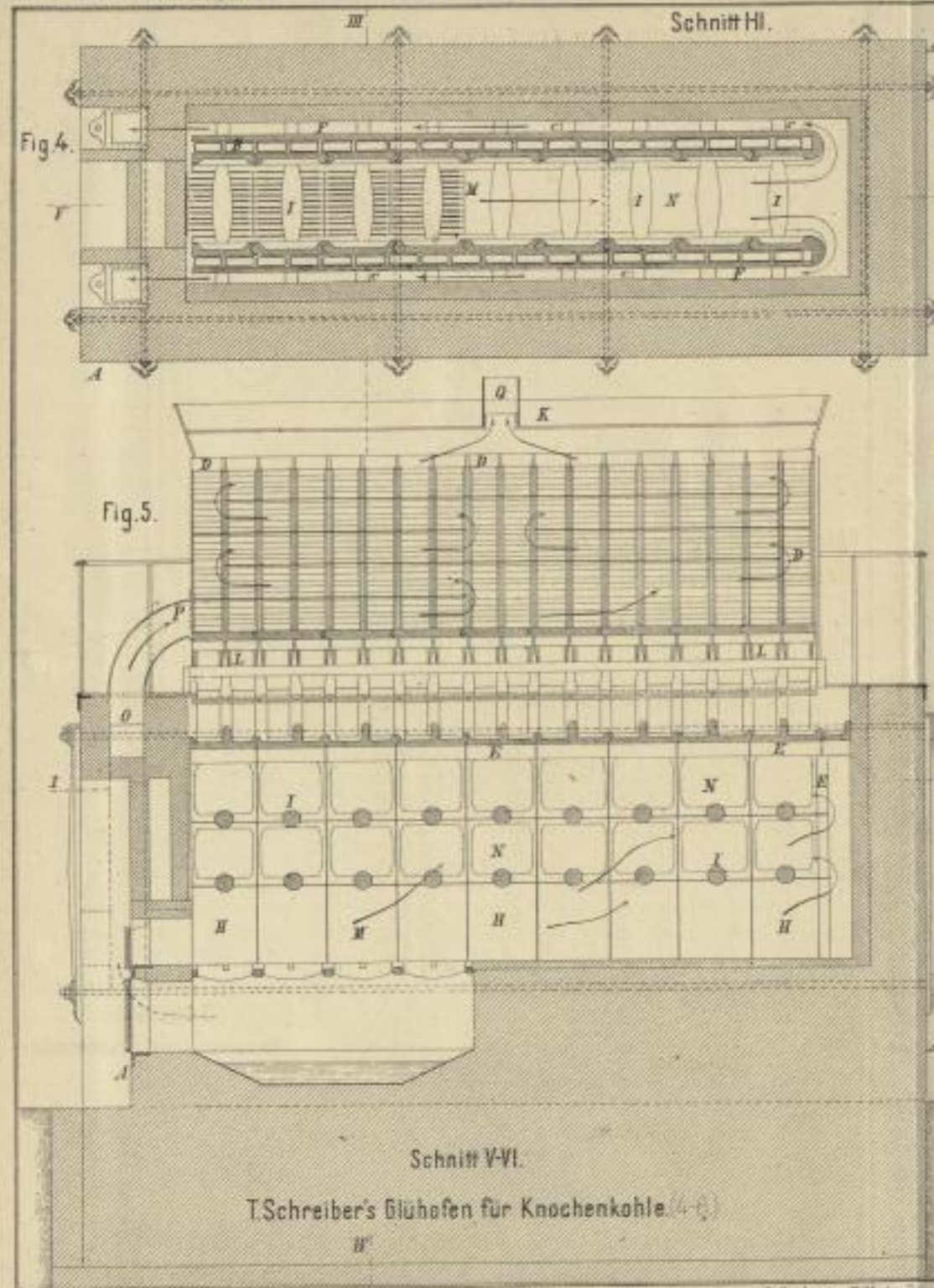

Lith. Anst. v. F. Witz, Darmstadt.



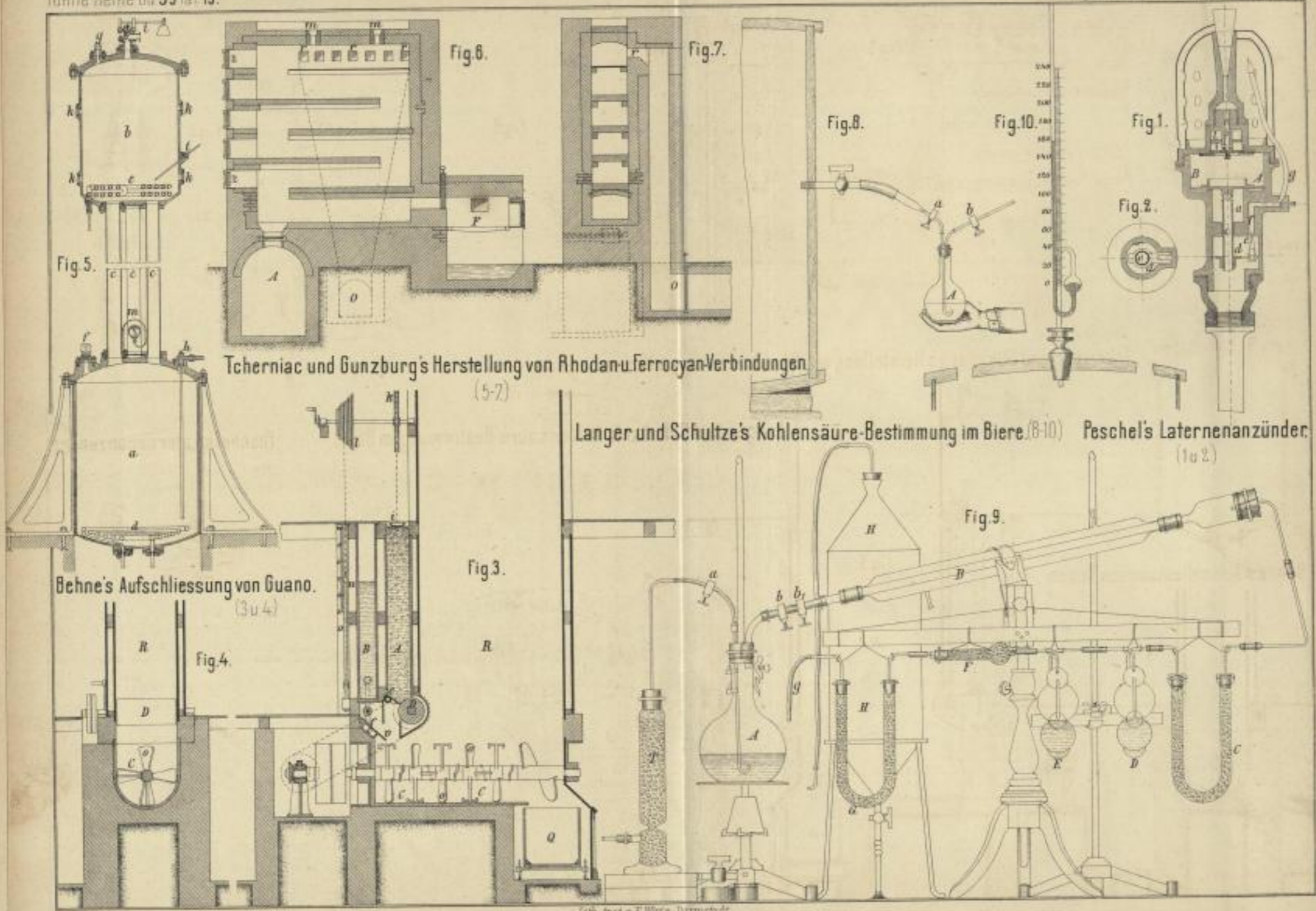

Fig. 5.

Fig. 6.

Fig. 7.

Fig. 8.

Fig. 10.

Fig. 1.

Fig. 2.

(5-7)

Langer und Schultze's Kohlensäure-Bestimmung im Biere (8-10)

Peschel's Laternenanzünder (1 u 2)

Behne's Aufschliessung von Guano. (3 u 4)

(3 u 4)

Fig. 3.

Fig. 9.

Lehr. Anst. v. F. Wörke, Darmstadt.



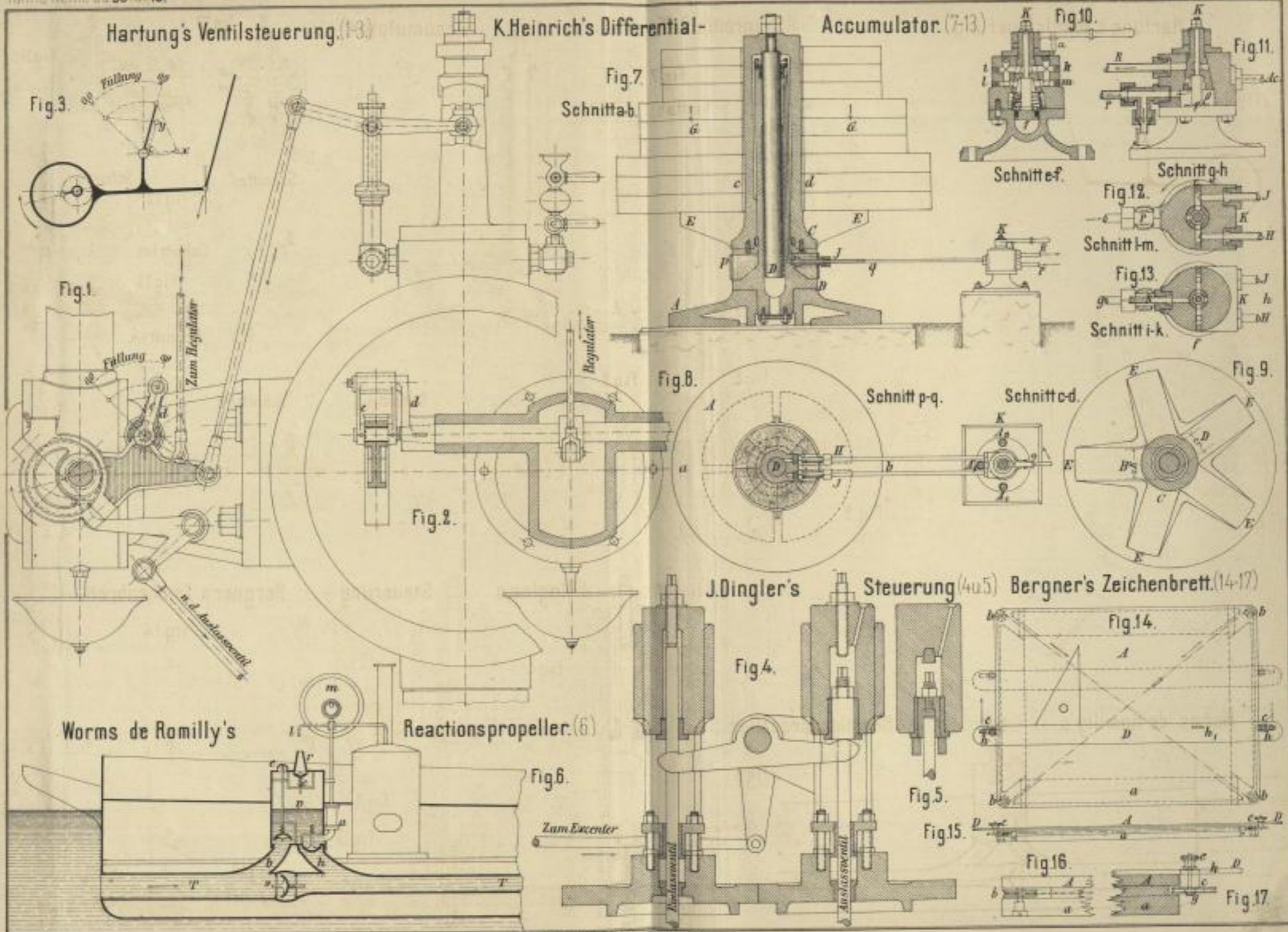

Lit. Anst. v. J. W. v. J. v. J.



Prött's Präzisionssteuerung. (1-4.)

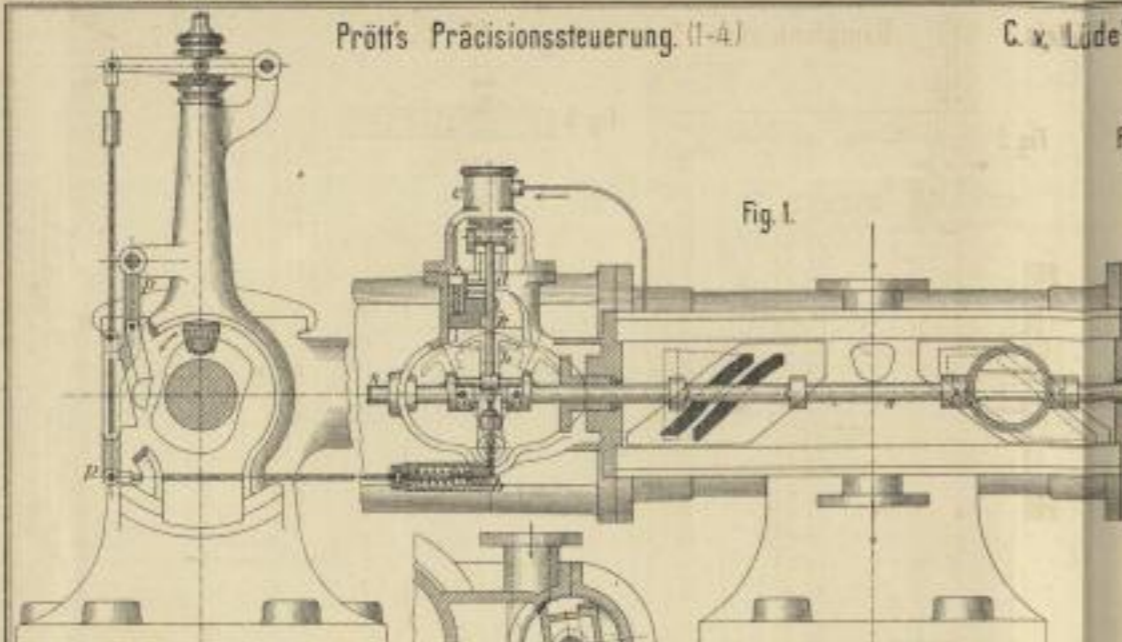

Fig. 1.

C. v. Lude's Dampfschieber - Schmierung. (5-7.)

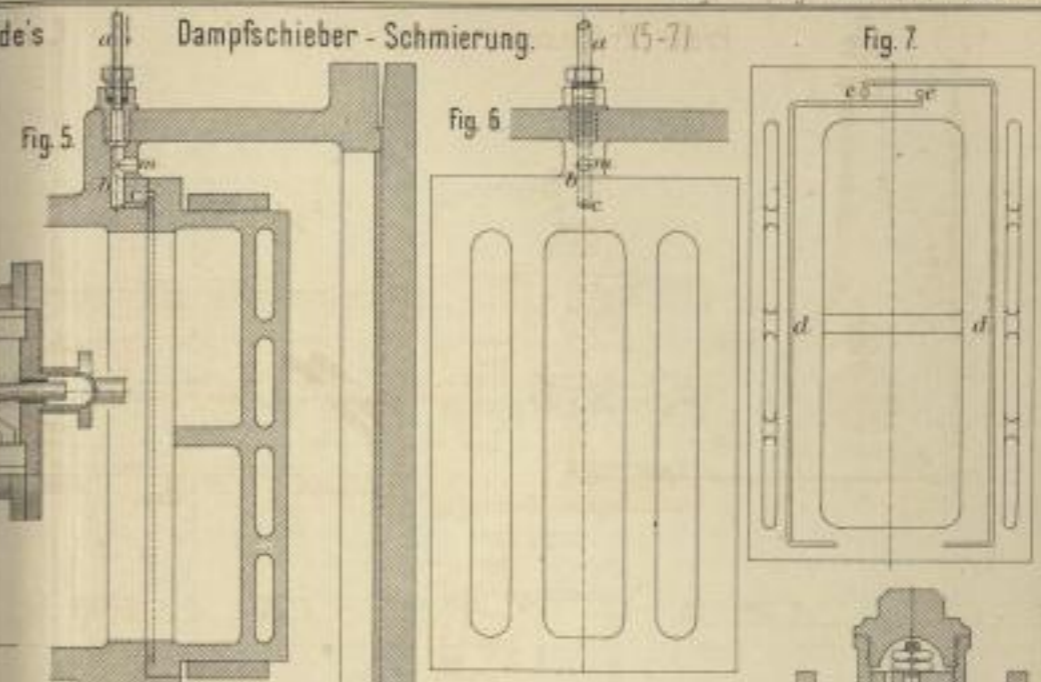

Fig. 5.

Fig. 6.

Fig. 7.

Fig. 2.

Fig. 3.

Wernicke und Herklotz's Rohrverbindung. (9 u 10.)

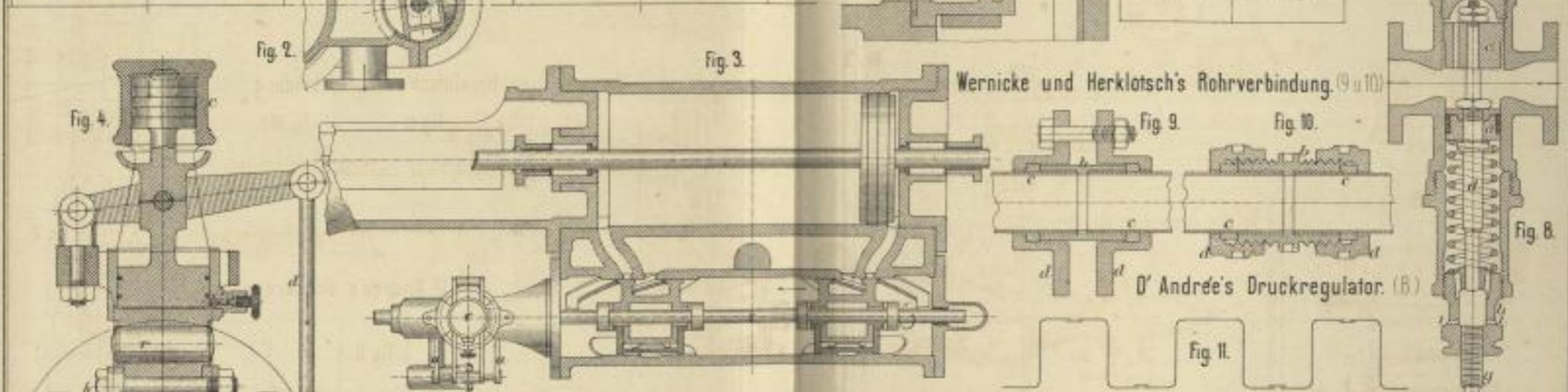

Fig. 4.

Fig. 9.

Fig. 10.

Fig. 8.

D'Andrée's Druckregulator. (11.)

Fig. 11.

E. de la Sauce's gefaltete Blechträger. (12-15.)

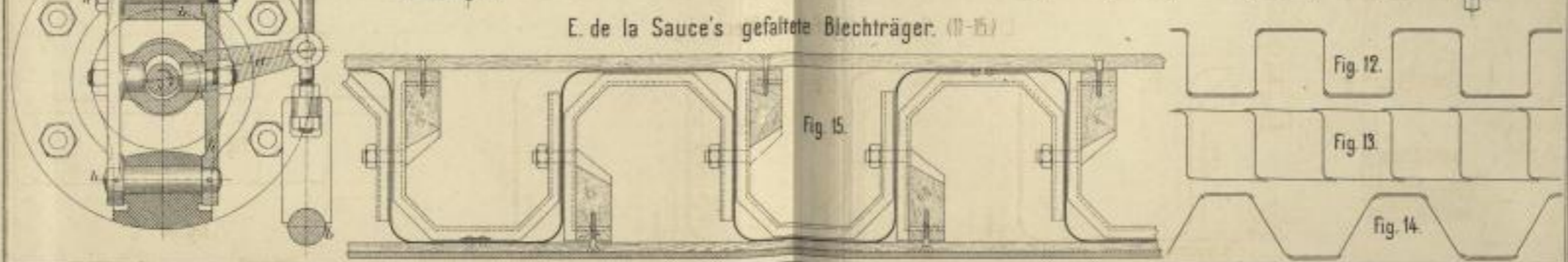

Fig. 12.

Fig. 13.

Fig. 14.

Fig. 15.

10th. Aufl. v. F. Kell. Zerschalt.



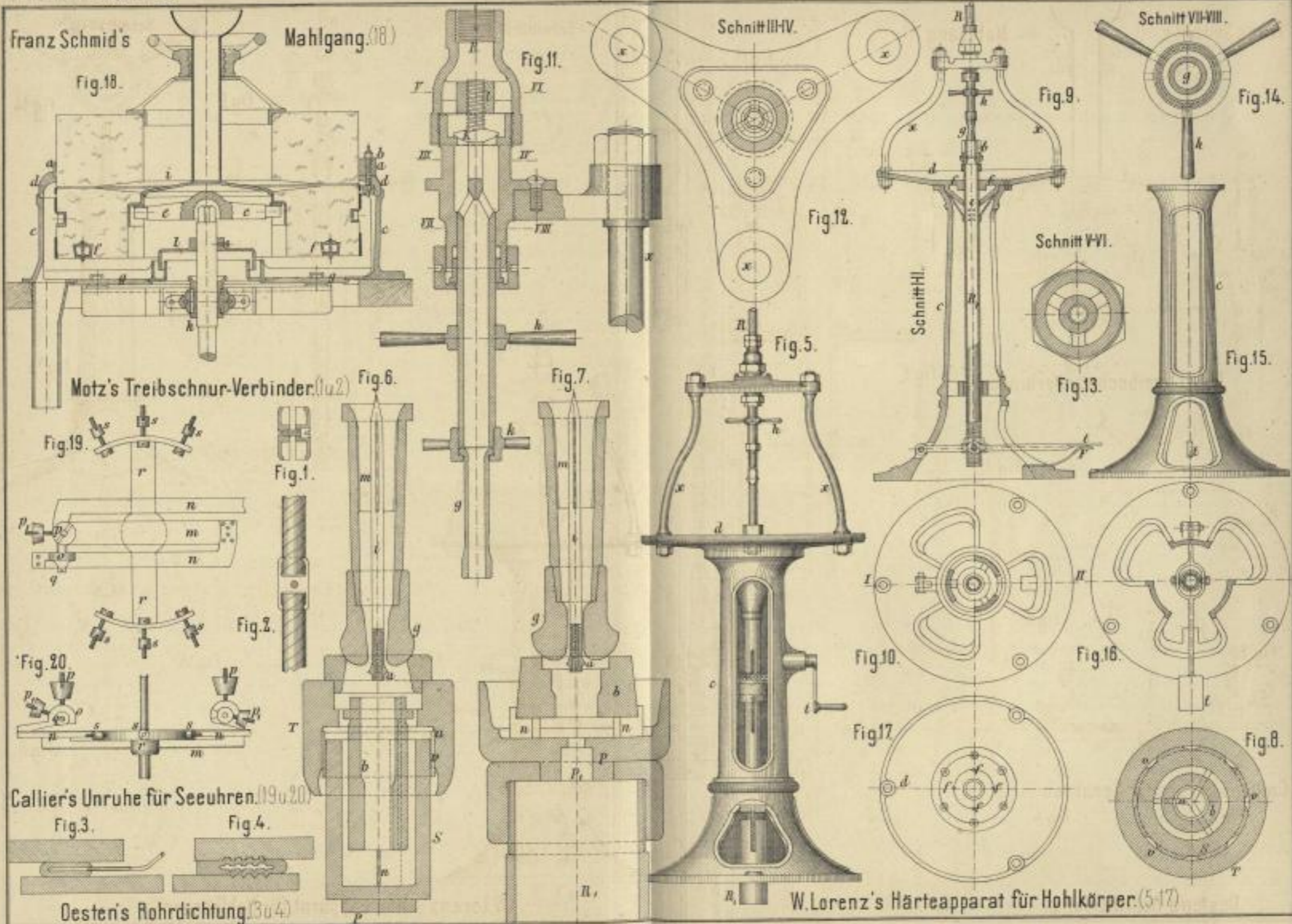

Lith. Anst. v. F. W. H. Darmstadt.



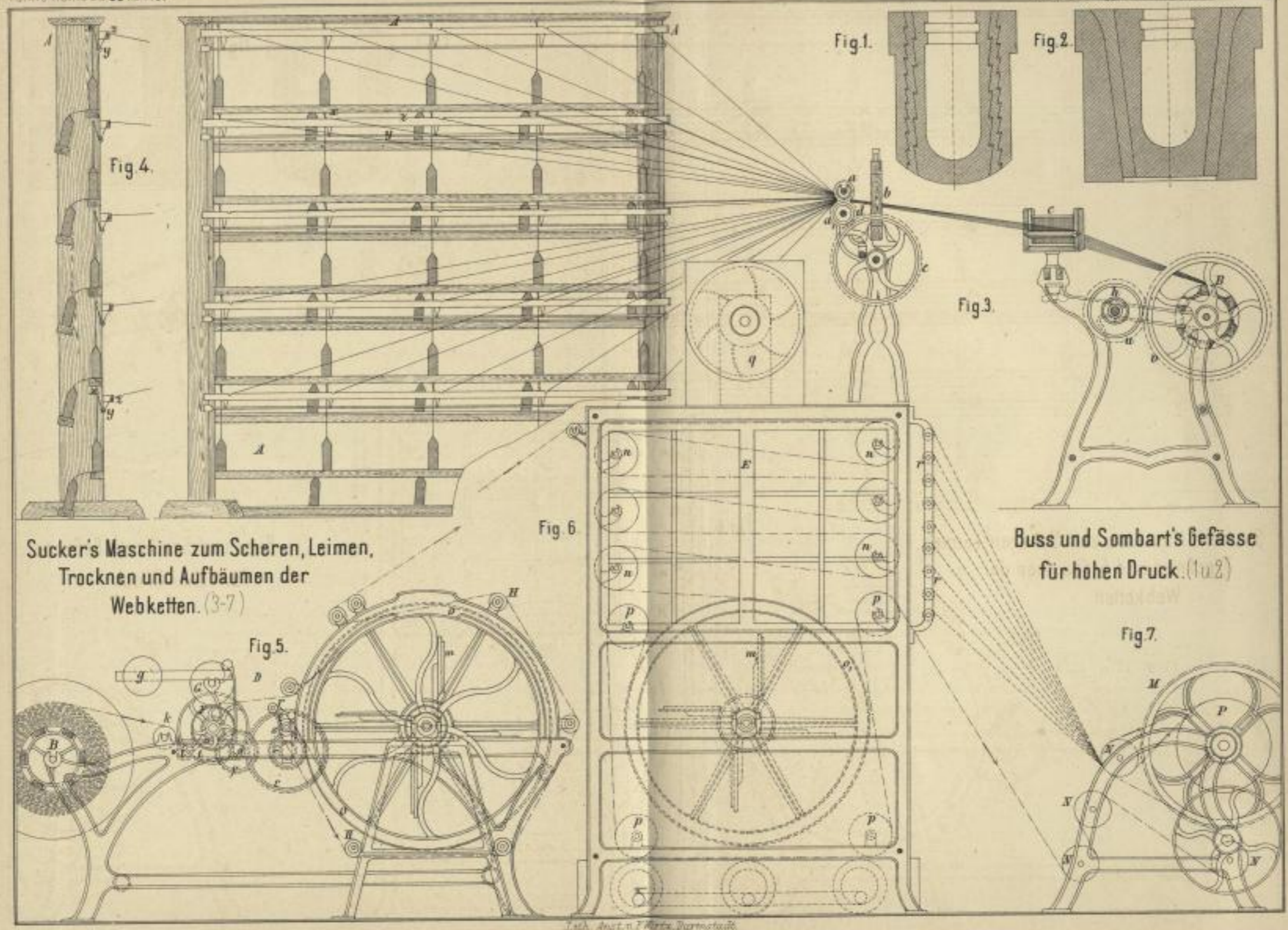

Sucker's Maschine zum Scheren, Leimen, Trocknen und Aufbäumen der Webketten. (3-7)

Buss und Sombart's Gefässe für hohen Druck. (1 u 2)

Lith. Anst. v. F. W. Meyer, Darmstadt.



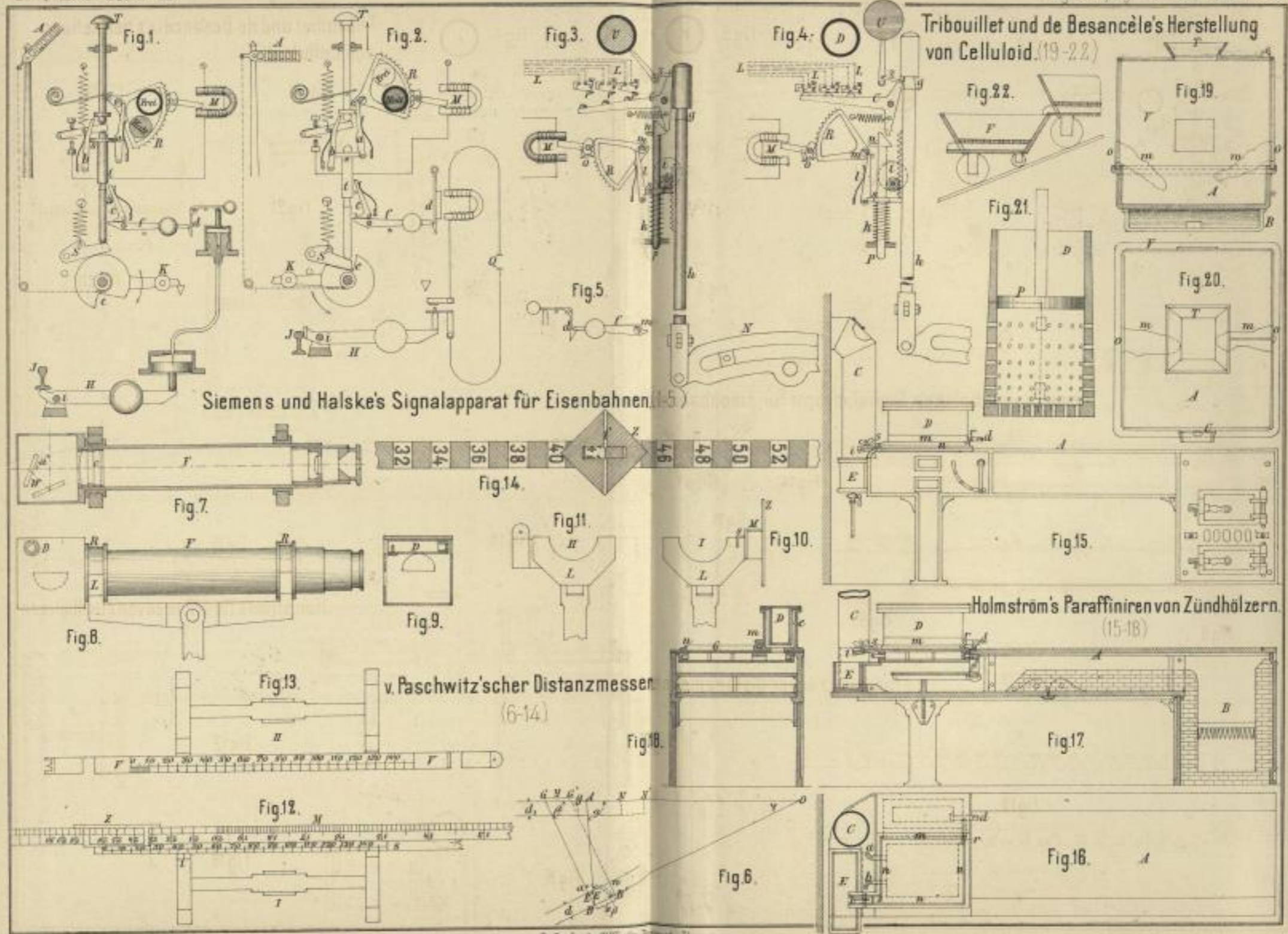

Siemens und Halske's Signalapparat für Eisenbahnen (1-5)

v. Paschwitz'scher Distanzmessen (6-14)

Tribouillet und de Besancèle's Herstellung von Celluloid (19-22)

Ich. Anst. v. F. W. v. Schönerbach



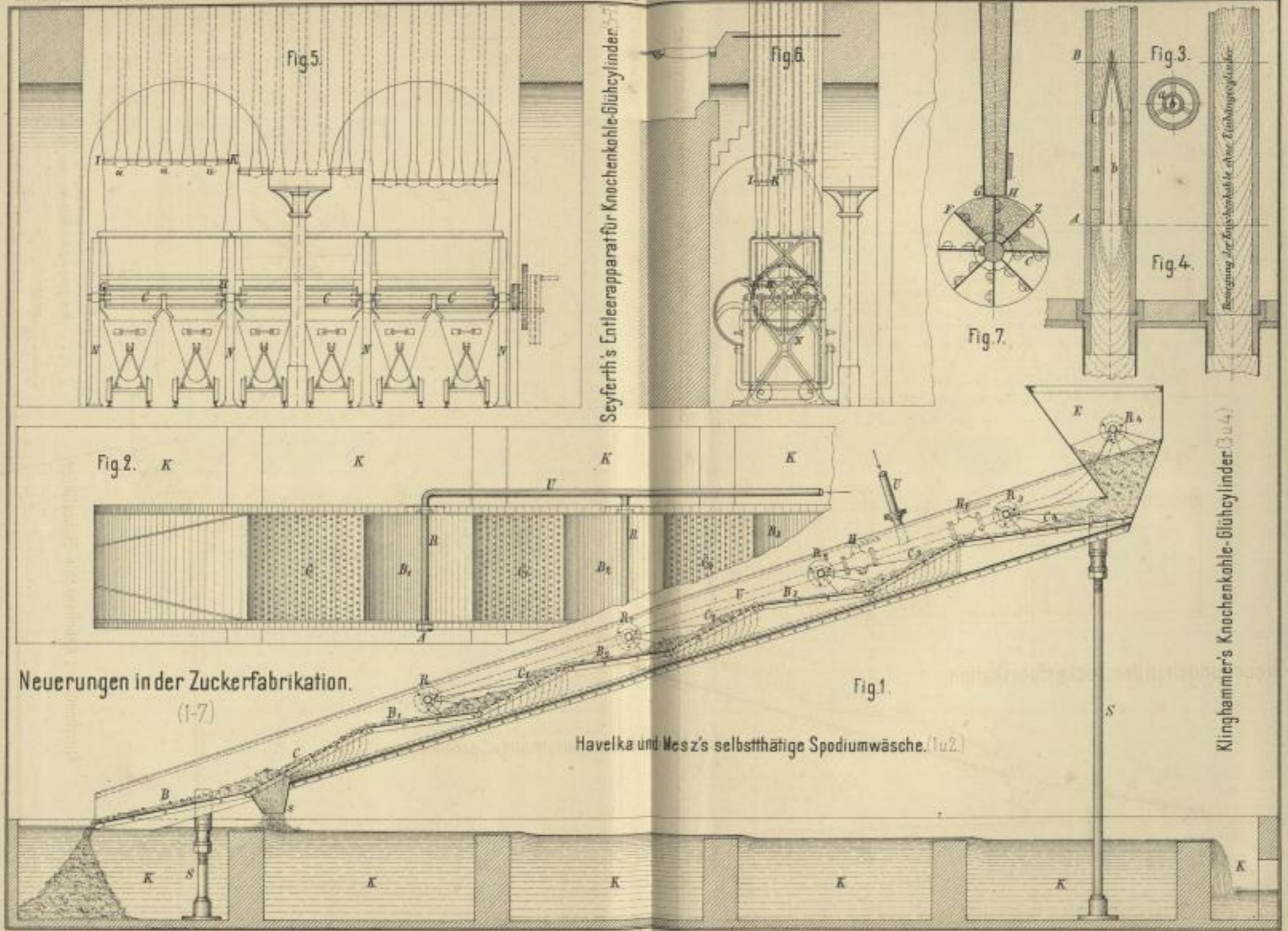

Seyferth's Entleerapparat für Knochenkohle-Glühcylinder. (Tu.5)

Klinghammer's Knochenkohle-Glühcylinder. (Tu.4)

Neuerungen in der Zuckerfabrikation. (1-7)

Havelka und Mesz's selbstthätige Spodiumwäsche. (Tu.2.)

Lebk. Anst. v. F. W. v. J. v. J.











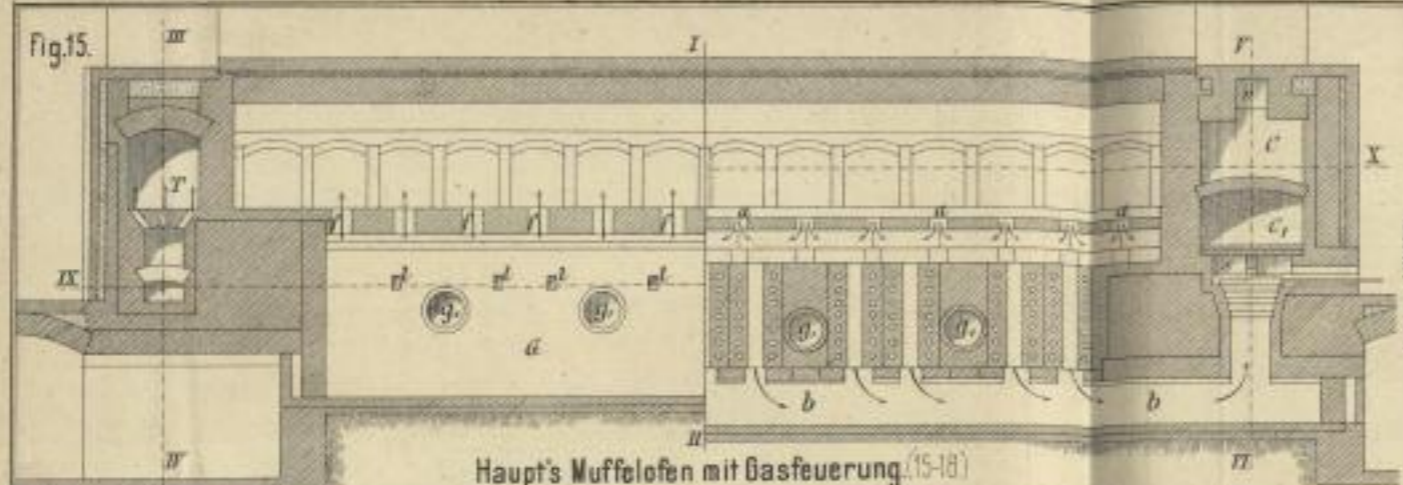

Haupt's Muffelofen mit Gasfeuerung (15-18)

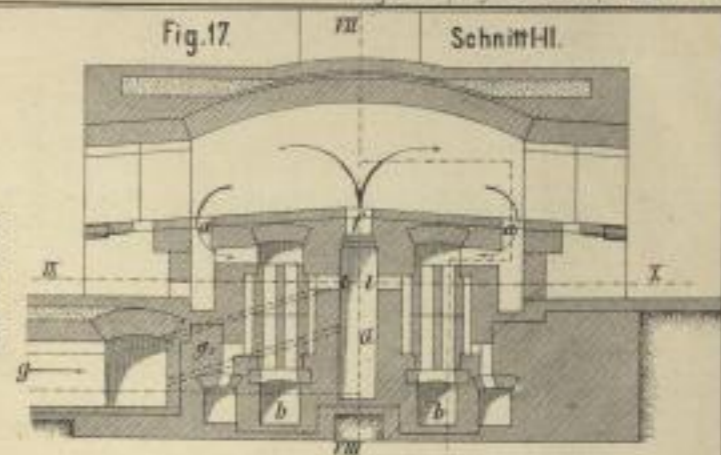
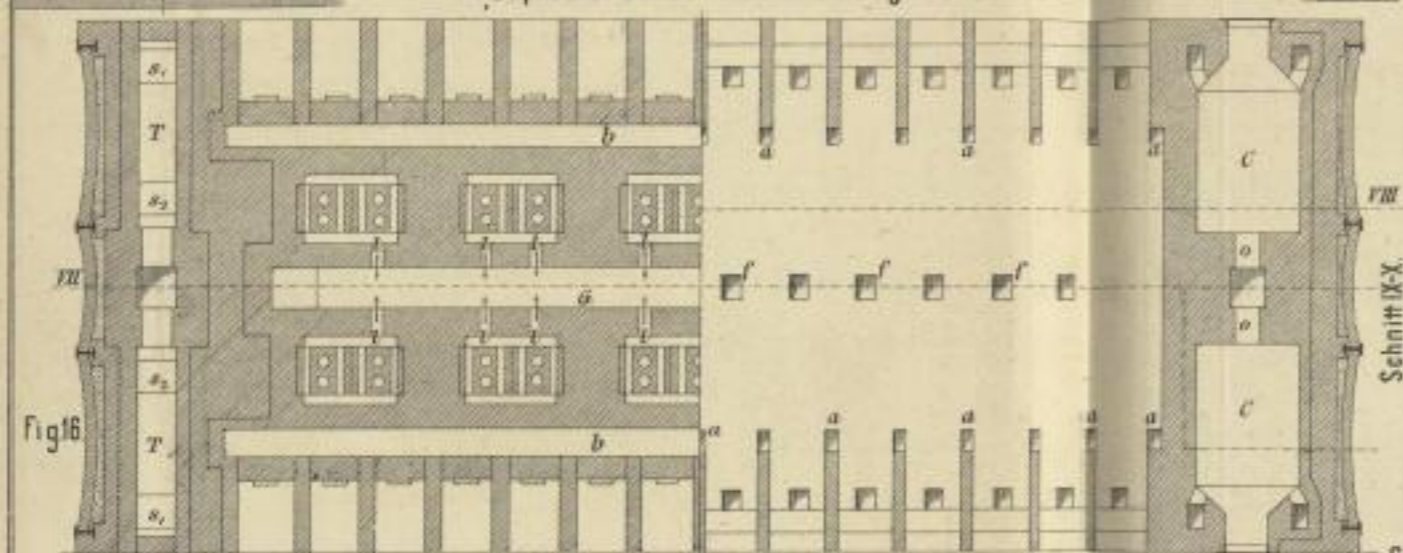

Fig. 17 Schnitt III.



Goodfellow's Apparat zur Bindung der Schwefligsäure (2 u 3)

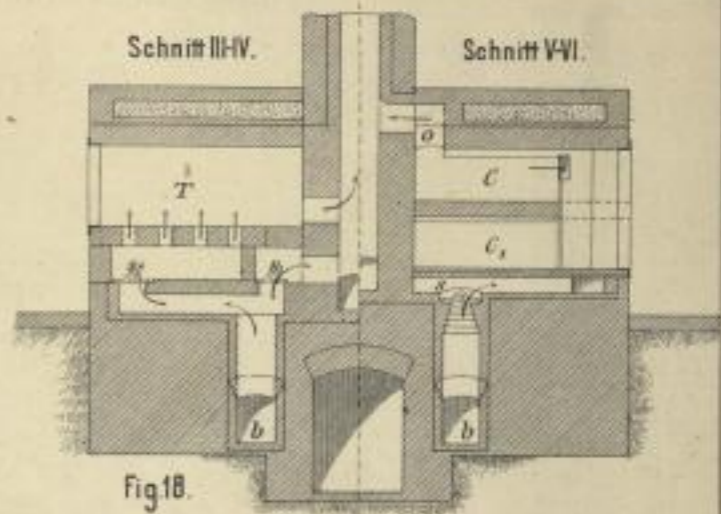
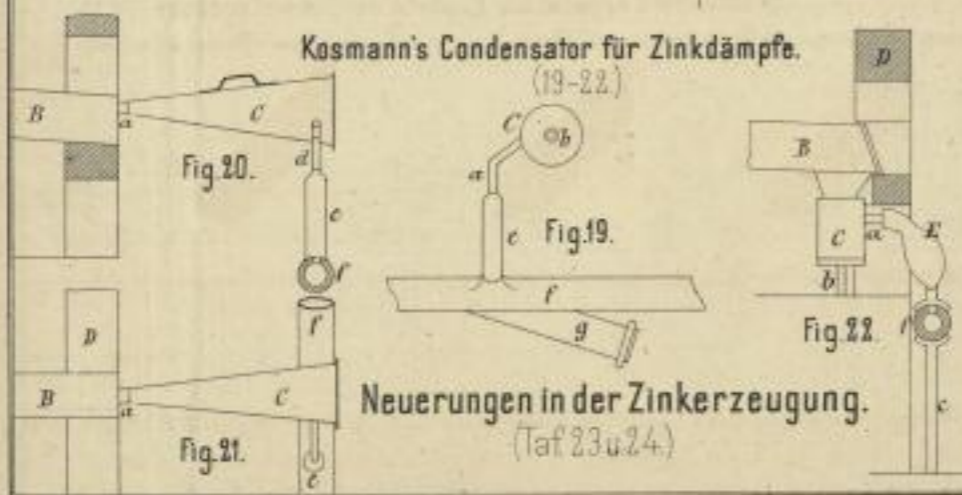

Fig. 18.



Kosmann's Condensator für Zinkdämpfe (19-22.)

Neuerungen in der Zinkerzeugung. (Taf 23 u 24.)

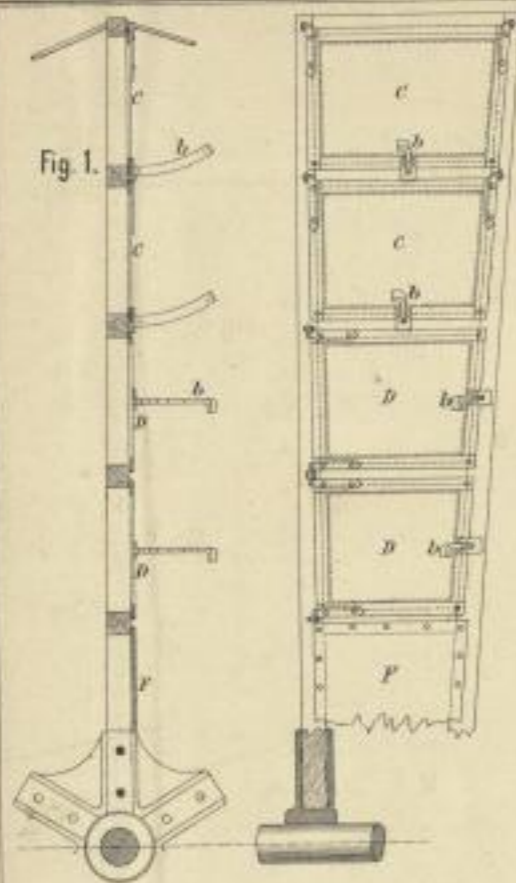

Fig. 3.

Self. Arch. u. J. W. v. S. v. S. v. S.



Neuerungen an Windrädern. (Taf. 25 u. 26.)



K. Schröder. (1-3)

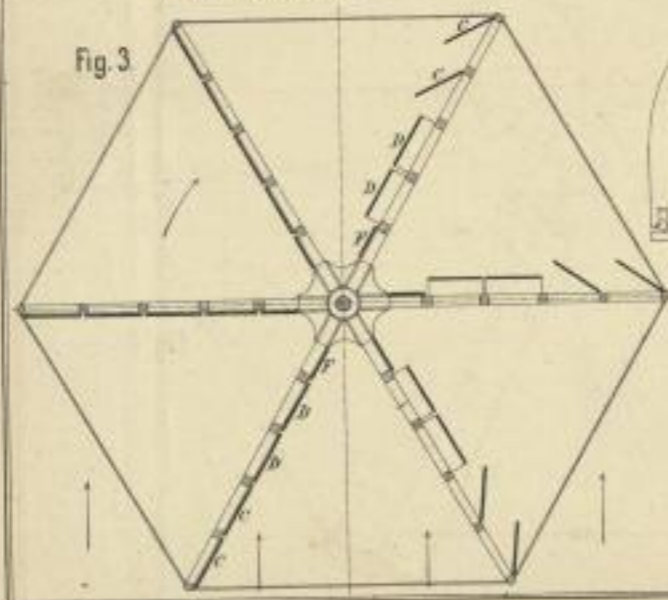

Fig. 2.

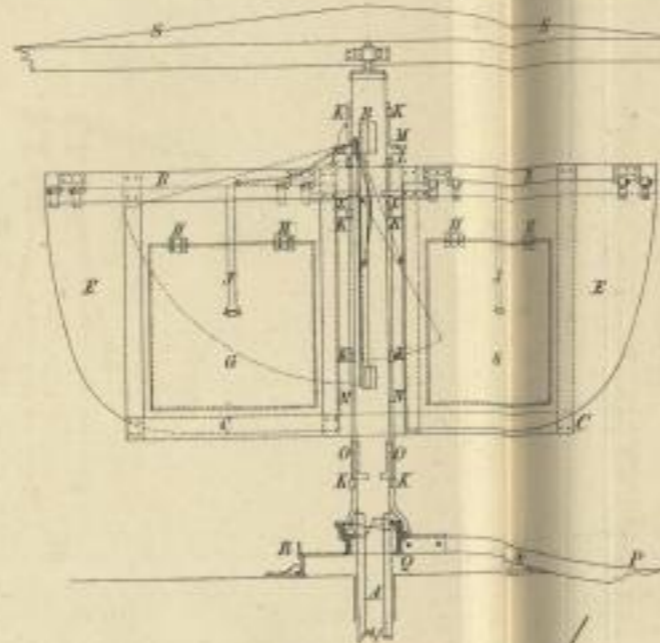

Fig. 14.

G. v. Eckenbrecher. (14 u. 15.)

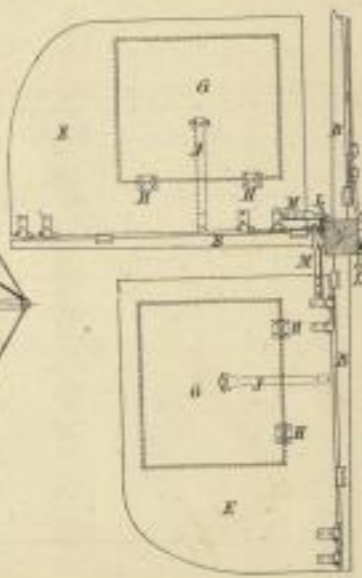

Fig. 15.

Stich. Aus d. Rev. Darmstadt.

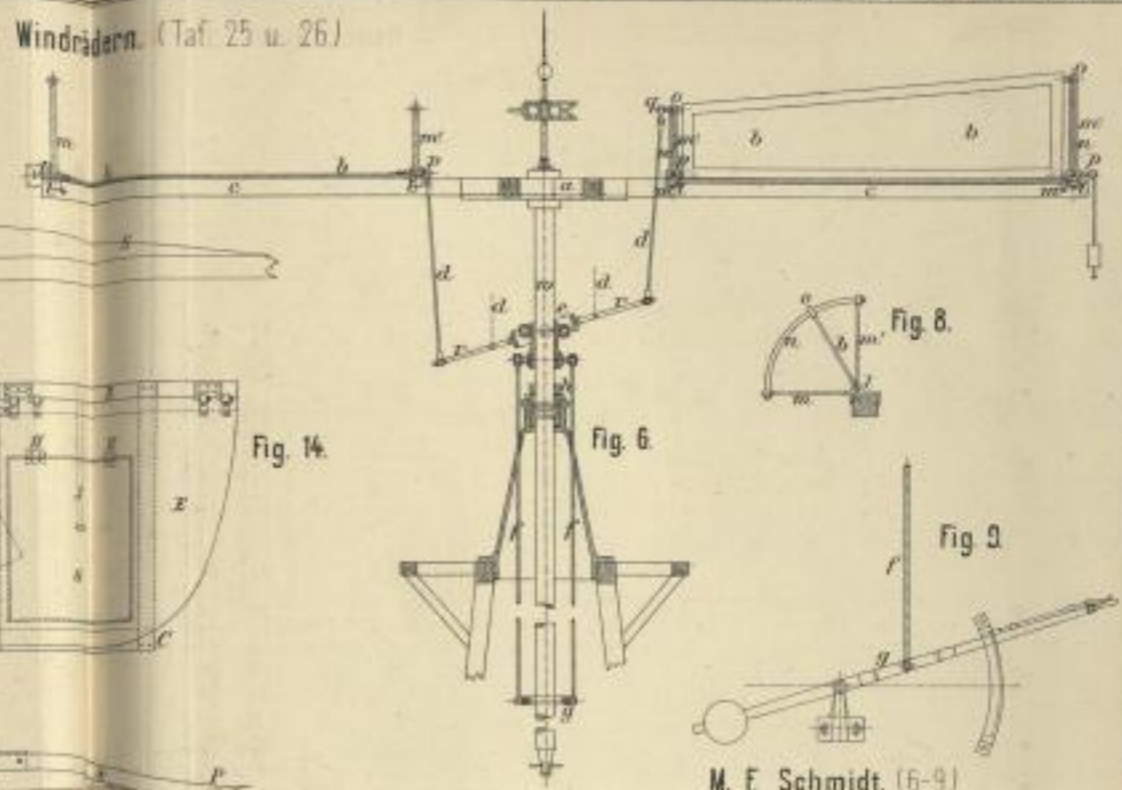

Fig. 6.

Fig. 8.

Fig. 9.

M. F. Schmidt. (6-9)

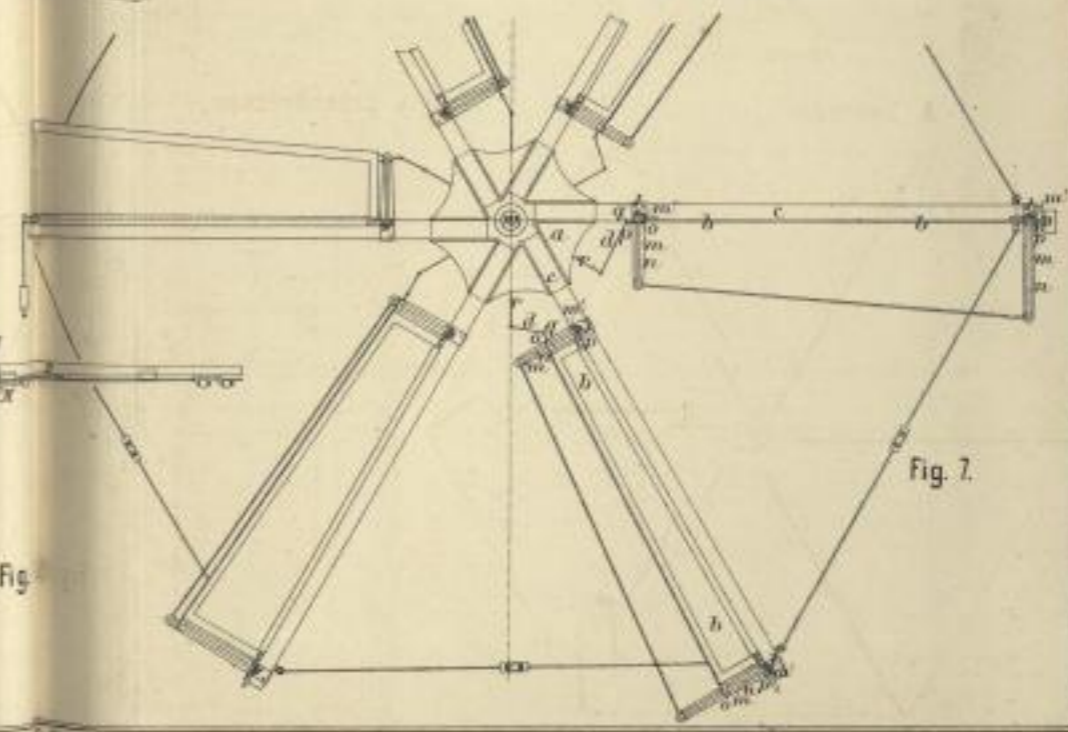
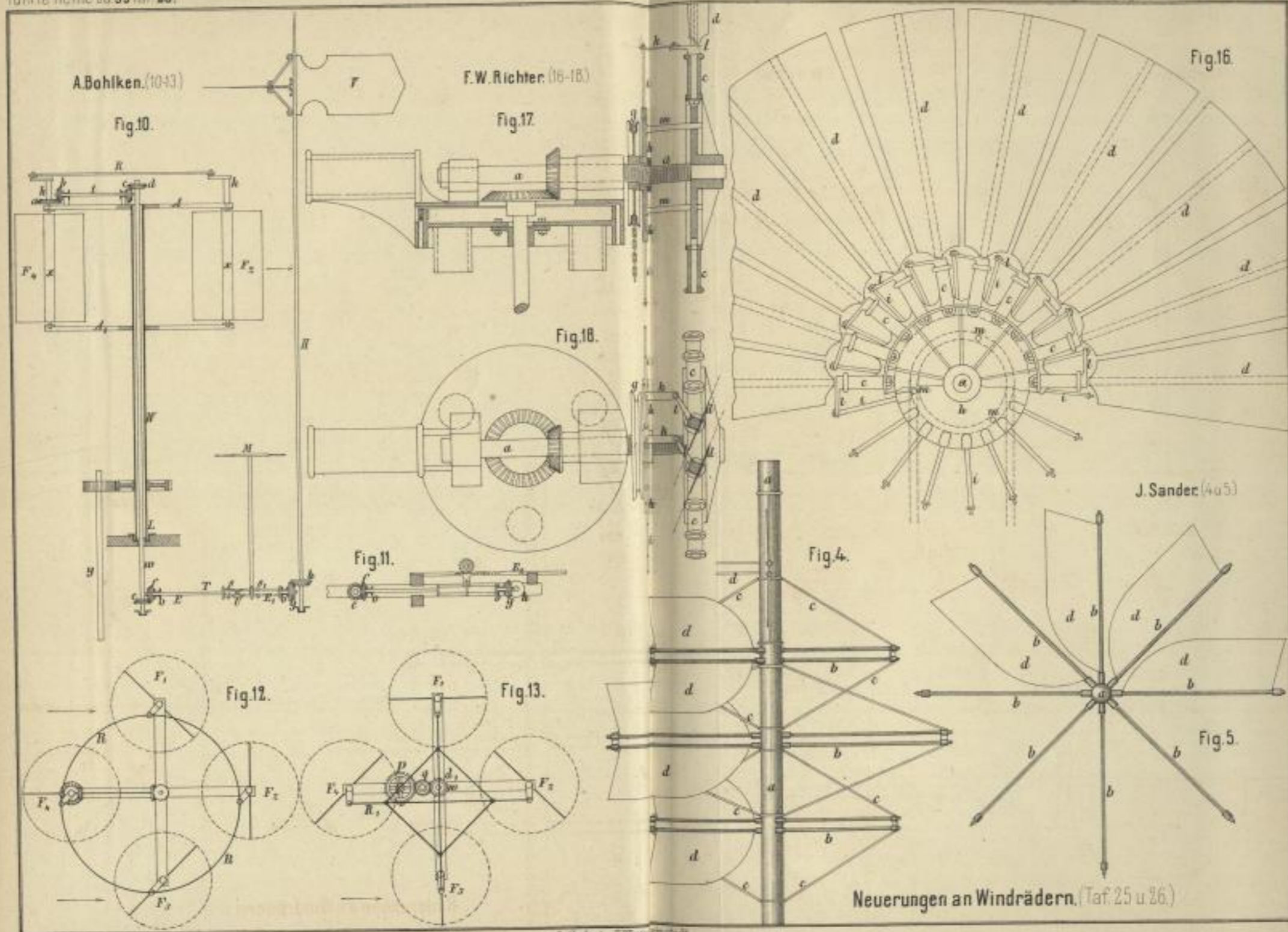

Fig. 7.





A. Bohlken. (10-13)

F. W. Richter. (16-18)

J. Sander. (4 u 5)

Neuerungen an Windrädern. (Taf. 25 u 26.)

Zich. d. h. v. F. W. Richter.





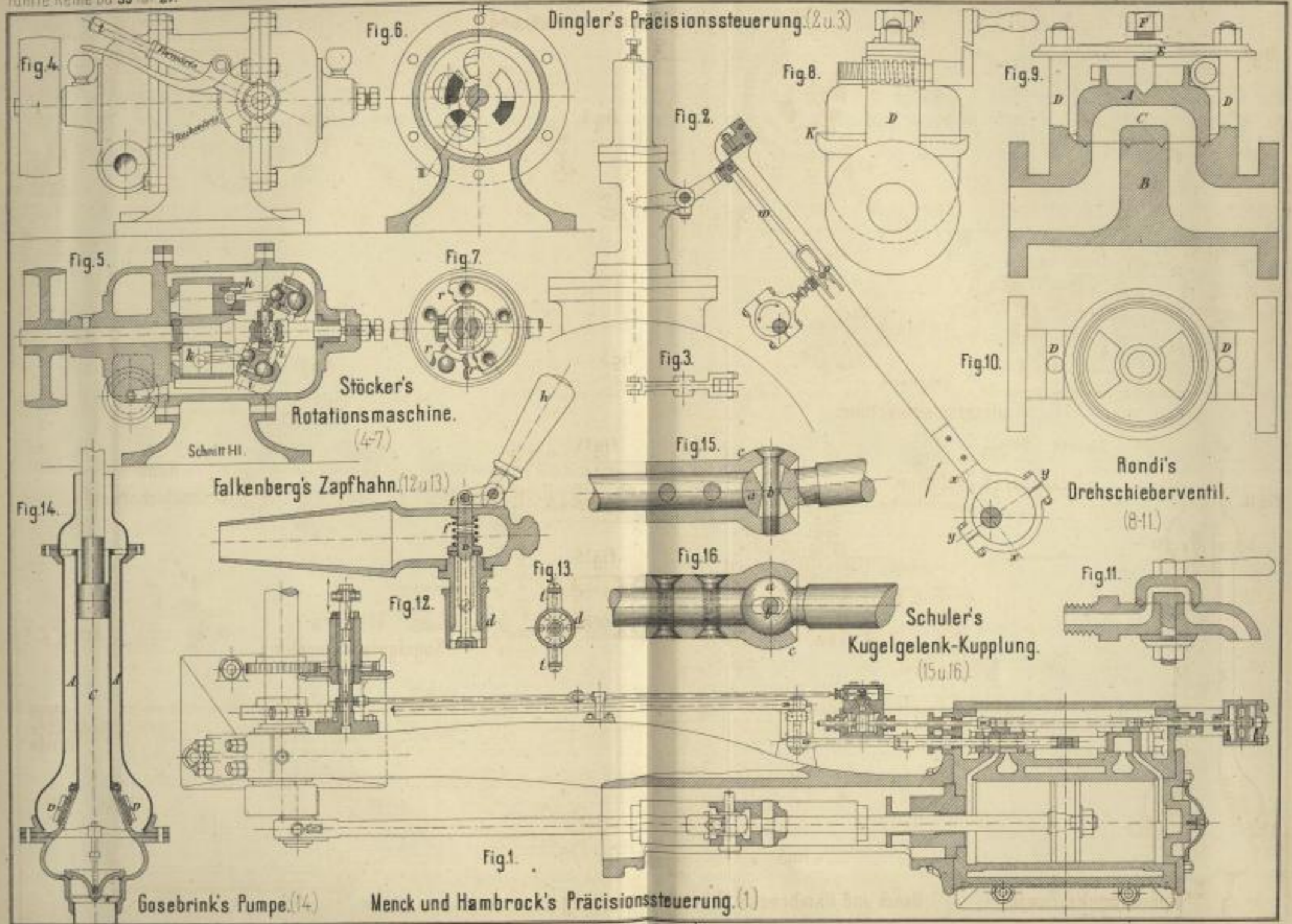

Zeich. Anst. v. F. Wörstl, Darmstadt.



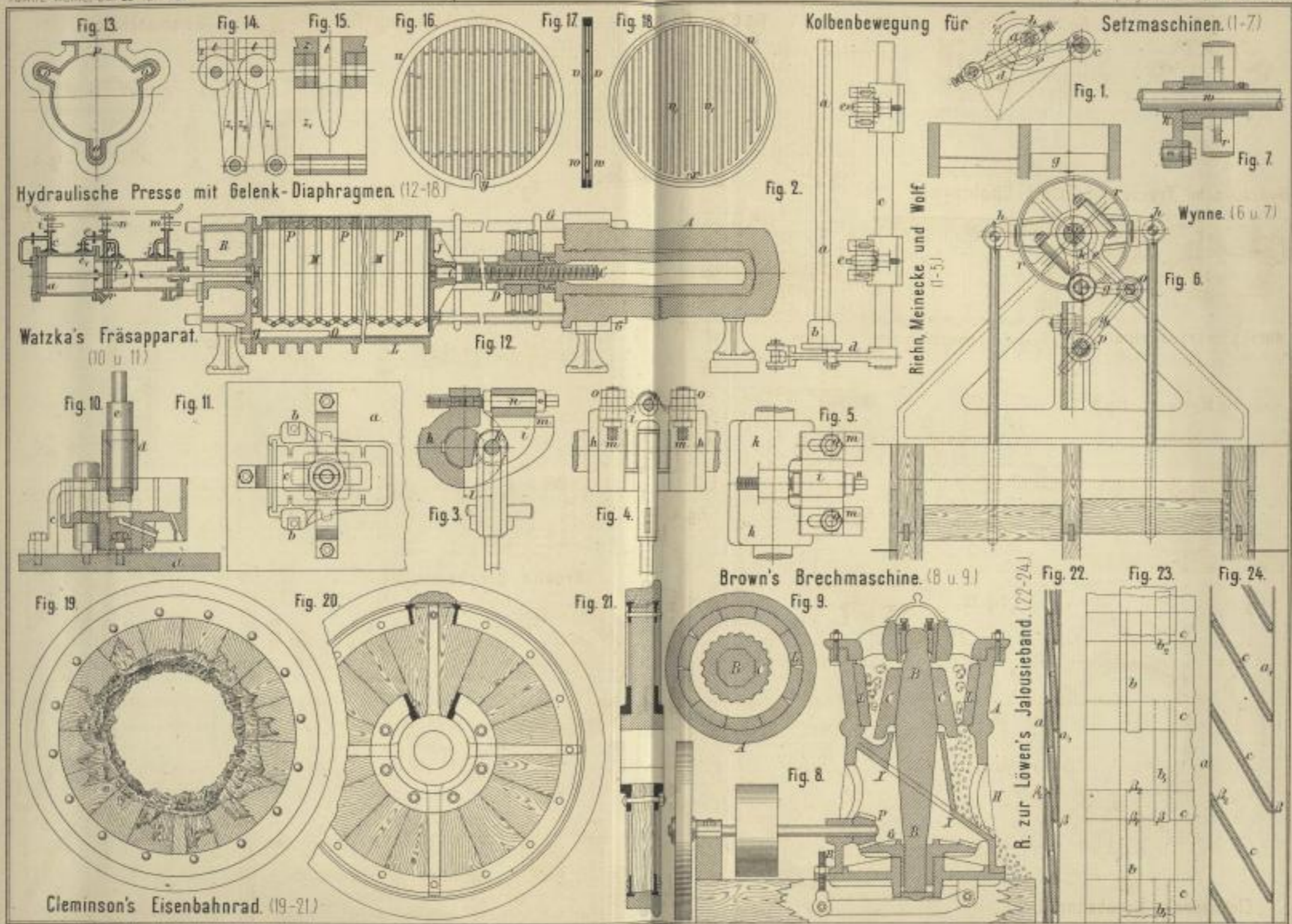

Lith. Anst. v. F. Kops, Darmstadt



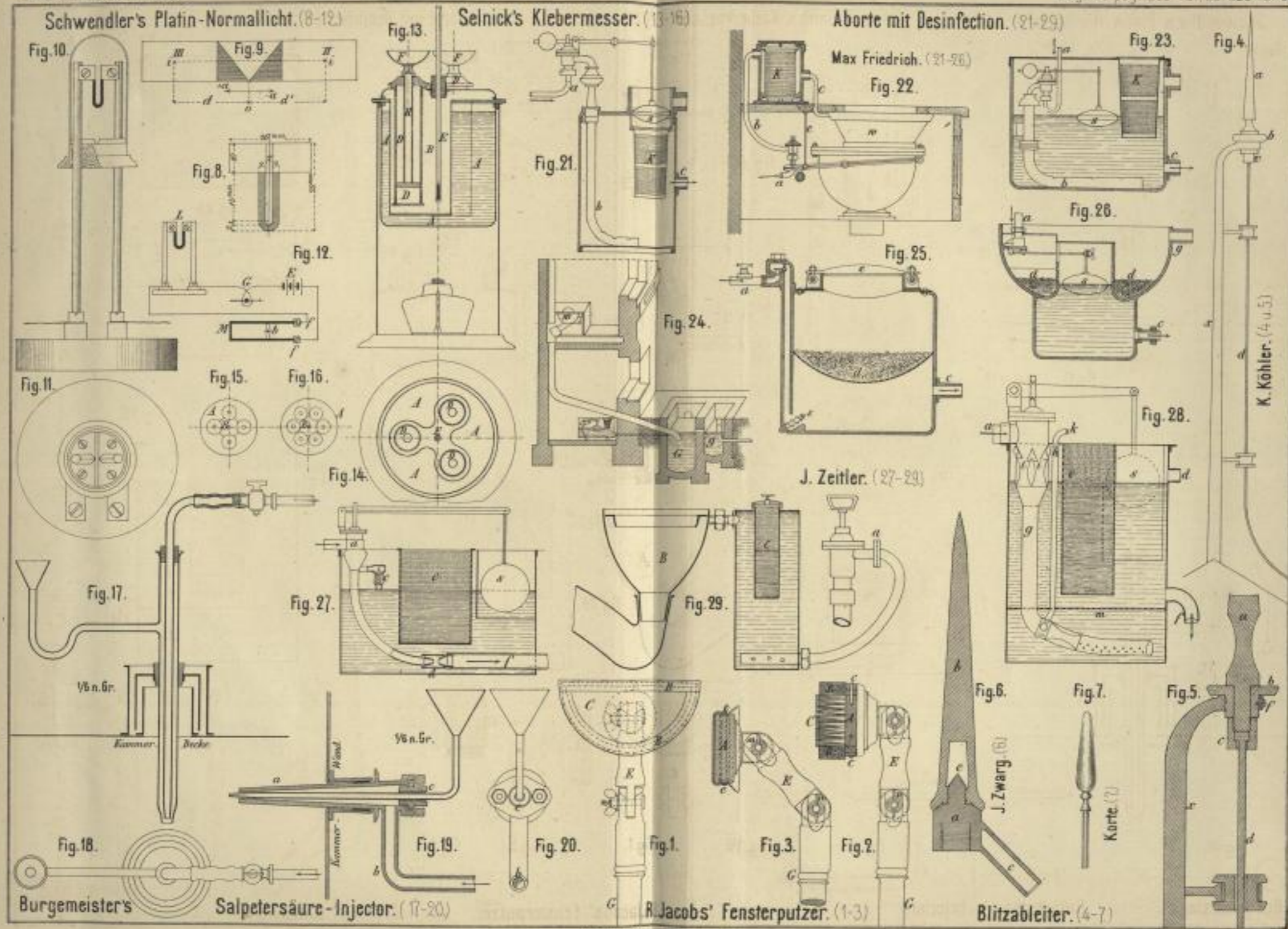

*Zeich. Anstalt von J. B. Bernhardt*



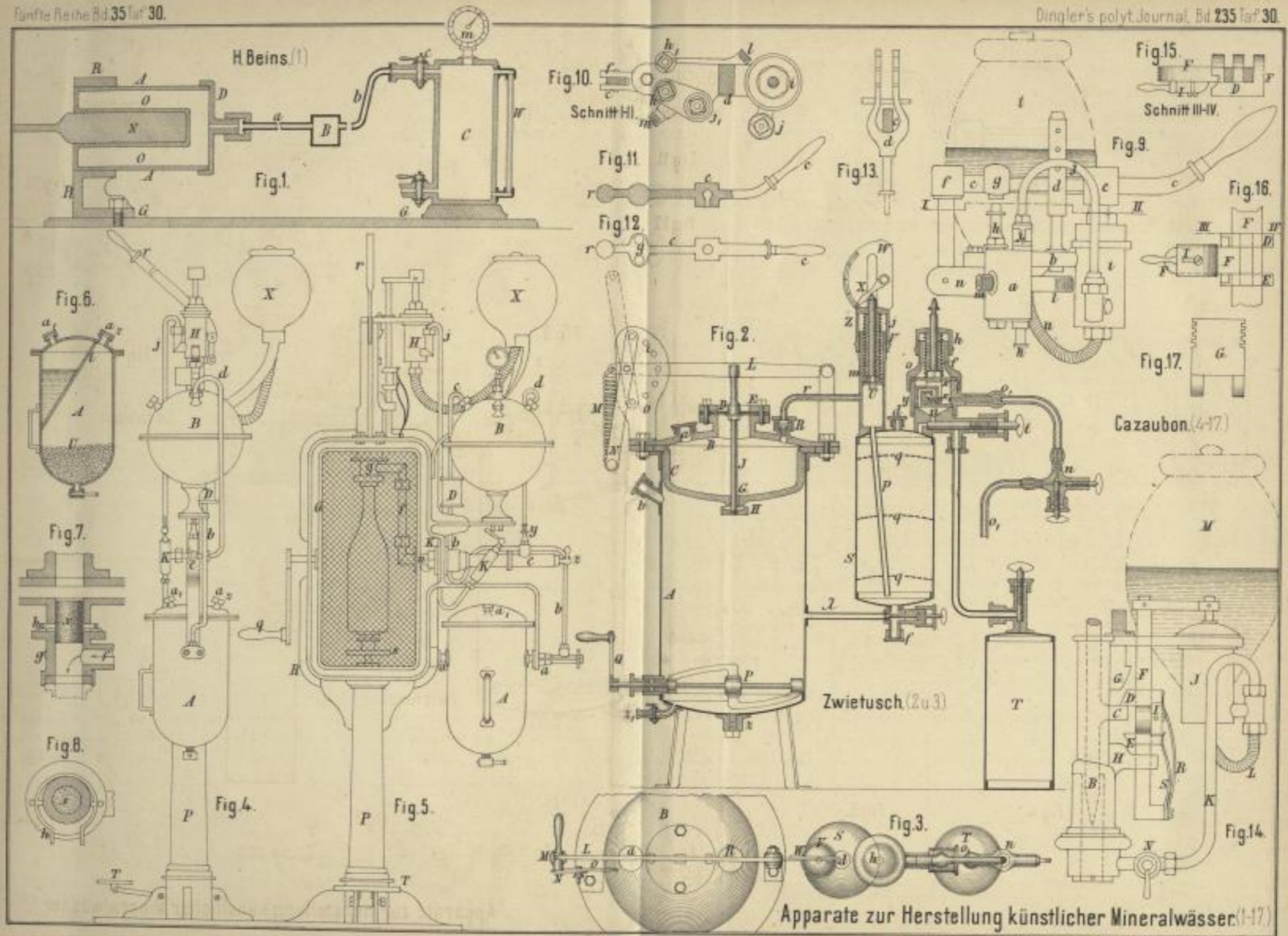



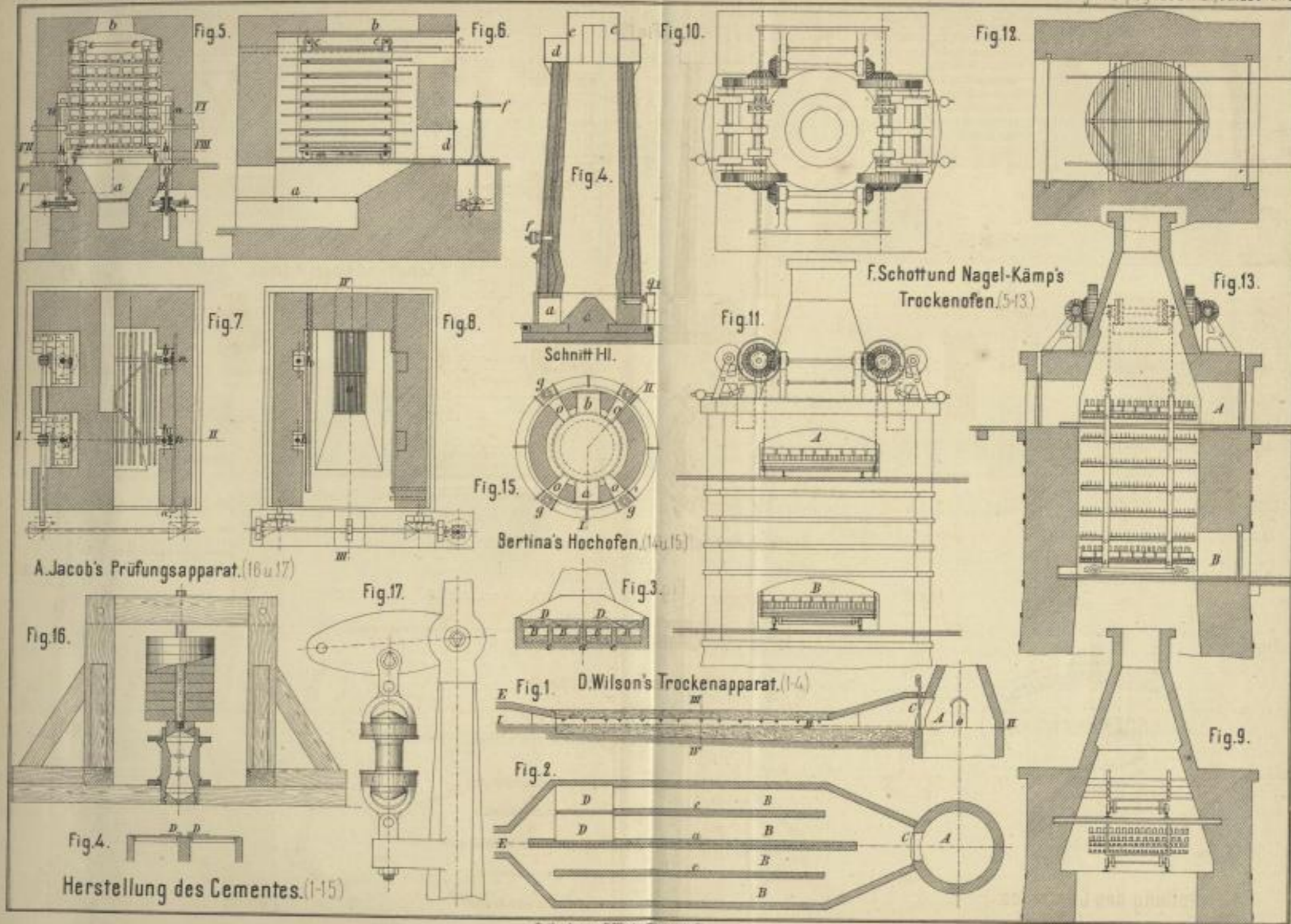

lith. Anst. v. F. Wörle, Nürnberg.



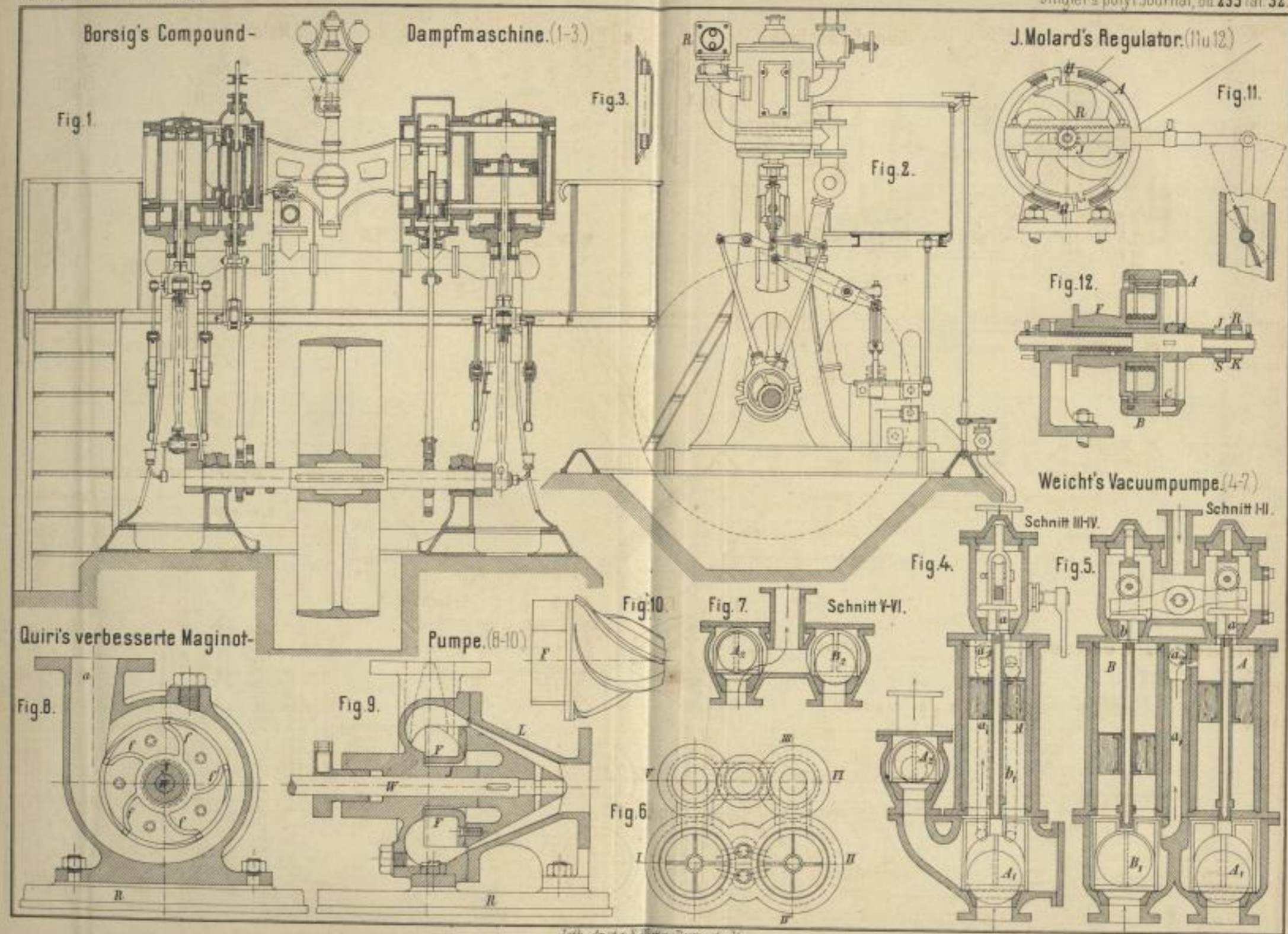



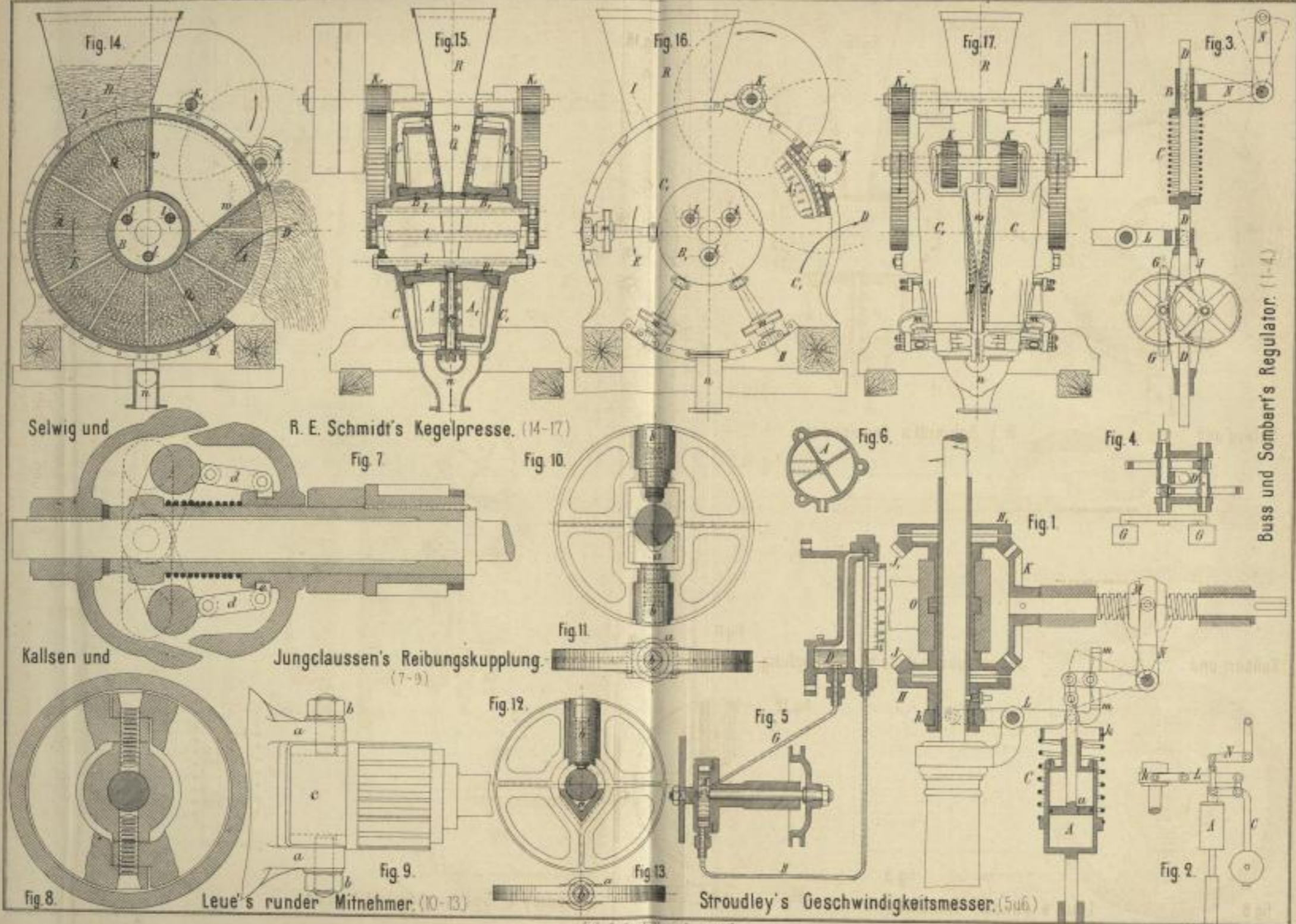

Buss und Sombar's Regulator. (1-4)

Lith. Anst. v. J. Neumann, Neudamm



# Neuerungen an Holzbearbeitungsmaschinen der Chemnitzer Werkzeugmaschinenfabrik

vormals Joh. Zimmermann. (119)

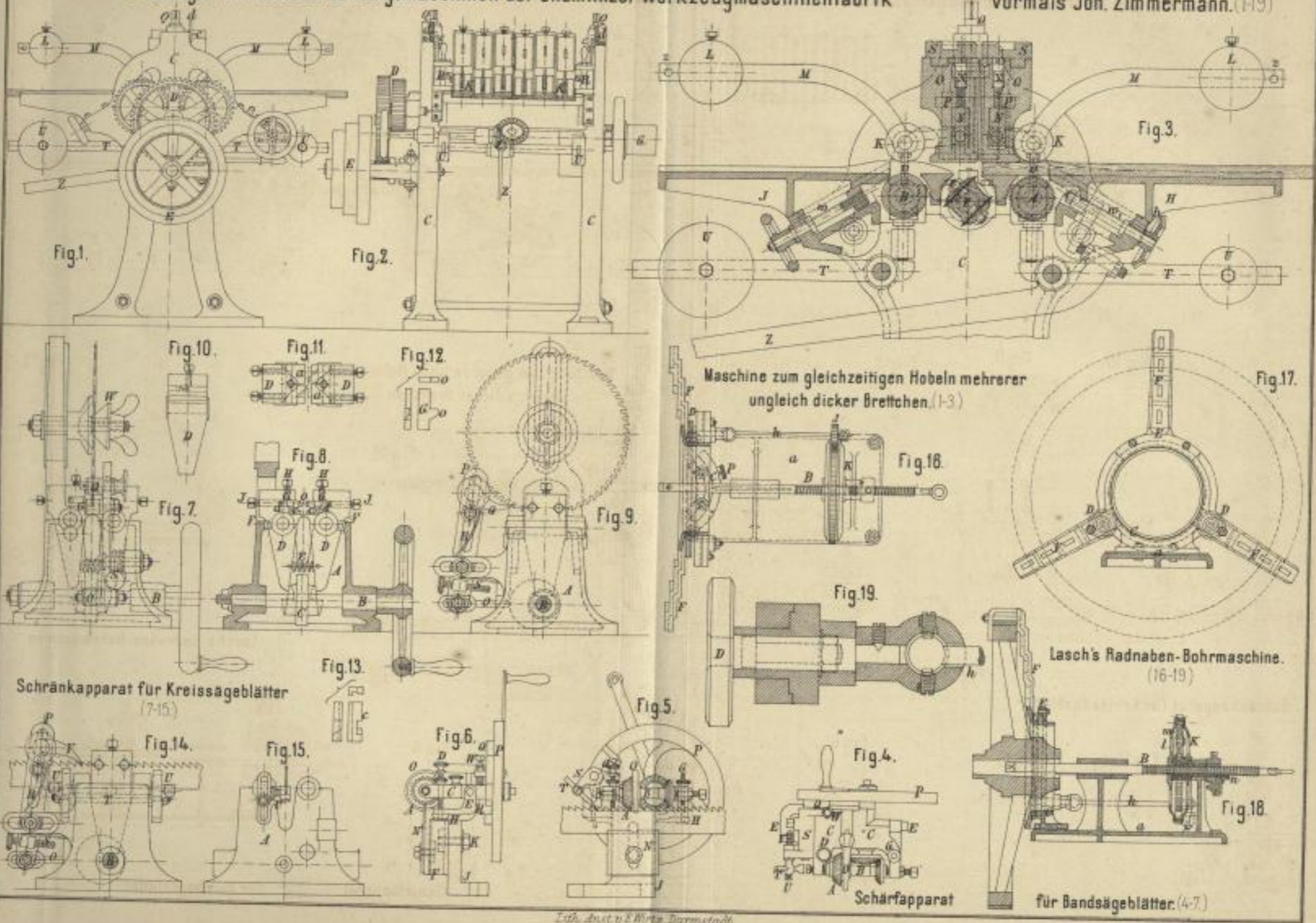

Ich. Anst. v. E. Wirtz, Darmstadt.



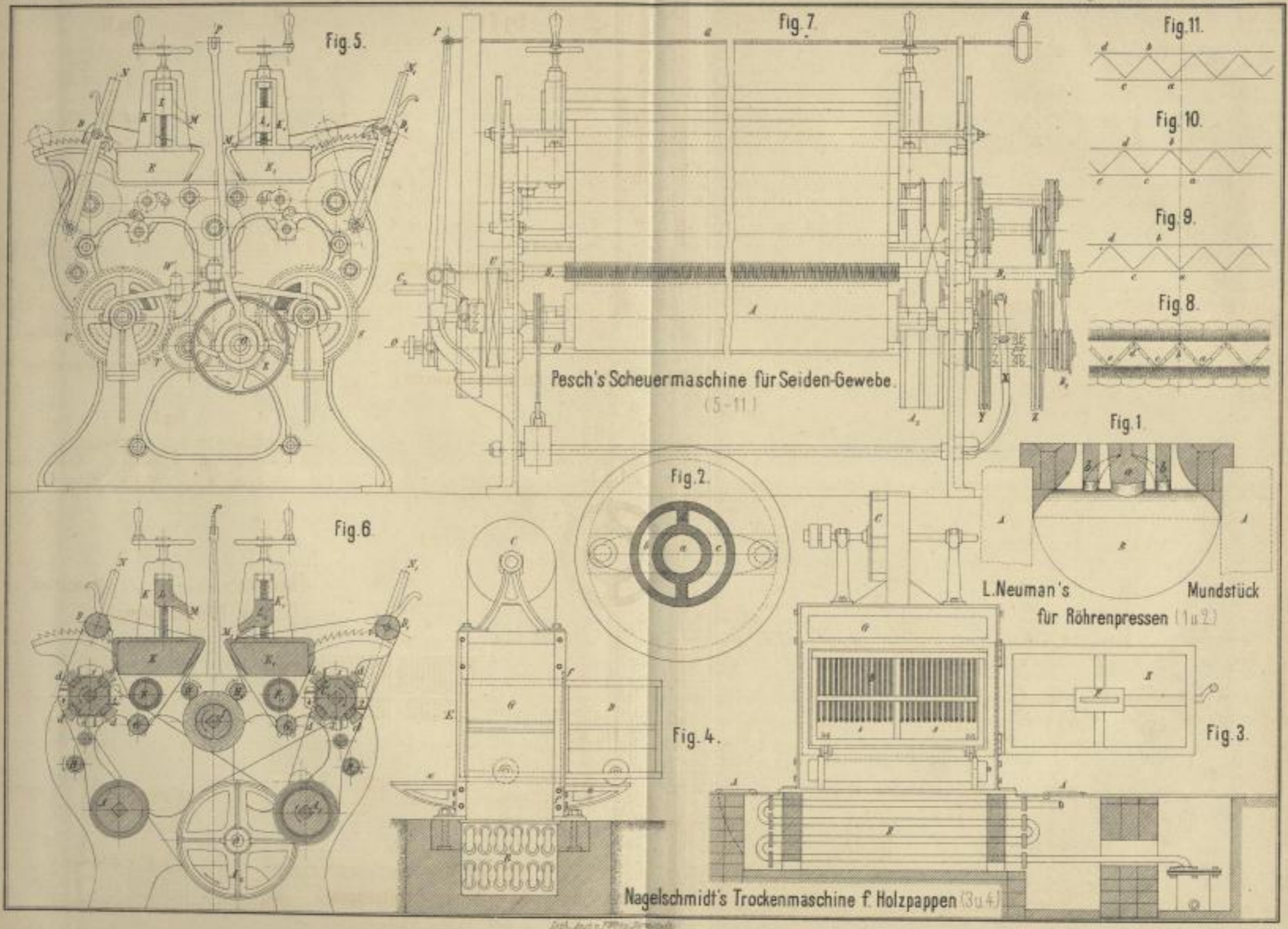

*Arch. Anst. v. 1870 für Gewerbe*





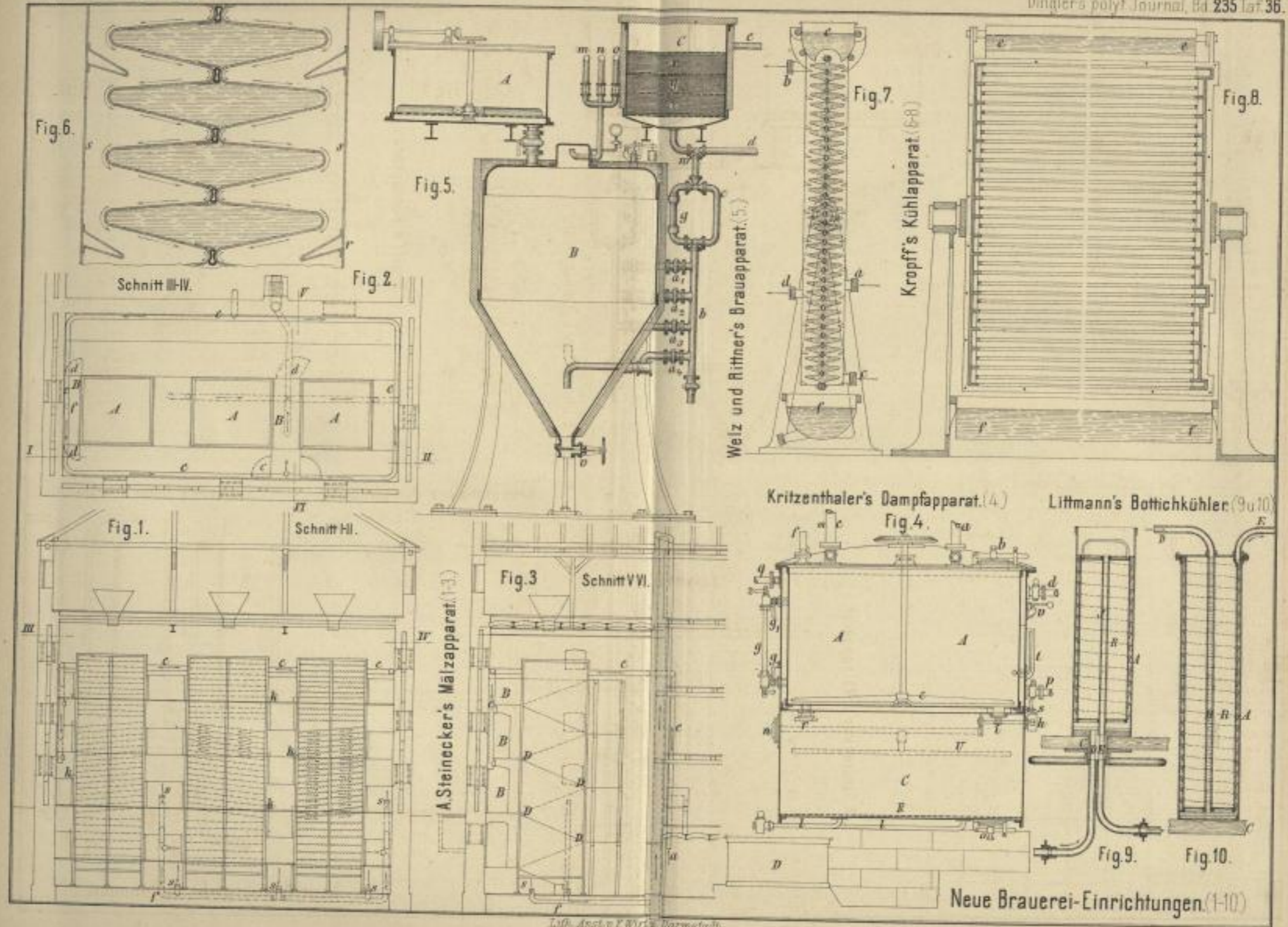

Neue Brauerei-Einrichtungen. (1-10)



M. Weinrich's Elutionsverfahren (5-14)

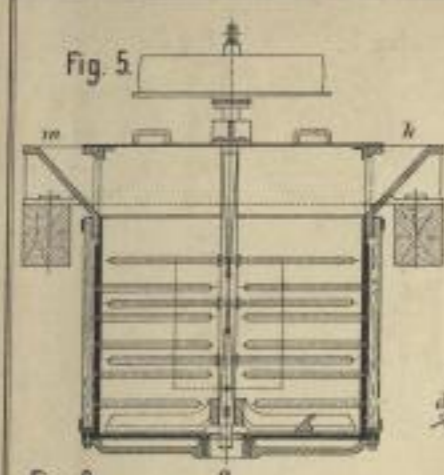

Fig. 5

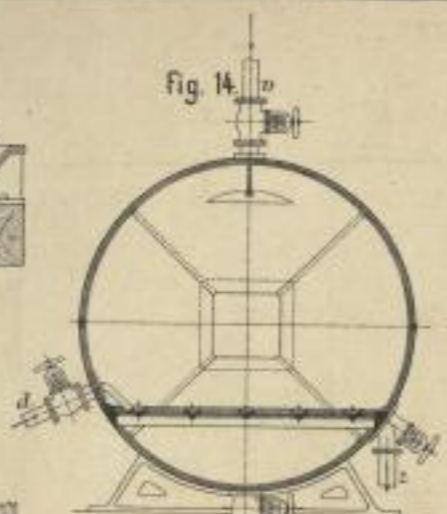

Fig. 14

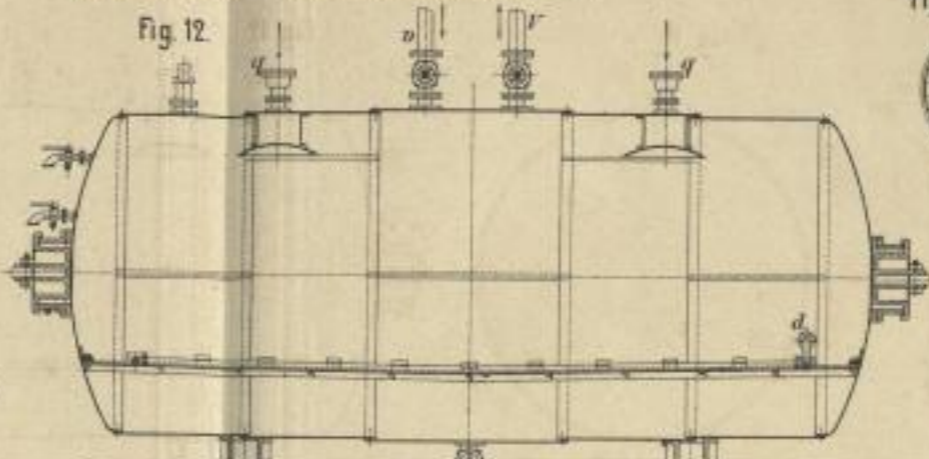

Fig. 12



Fig. 1

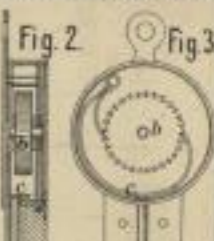

Fig. 3

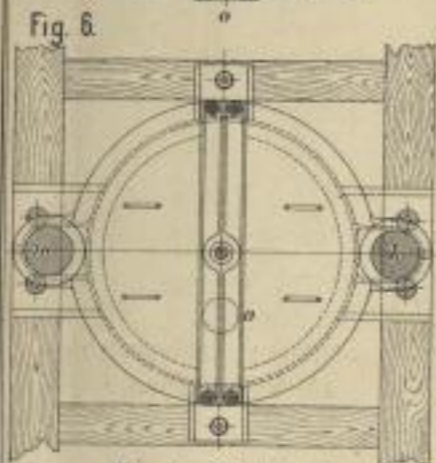

Fig. 6

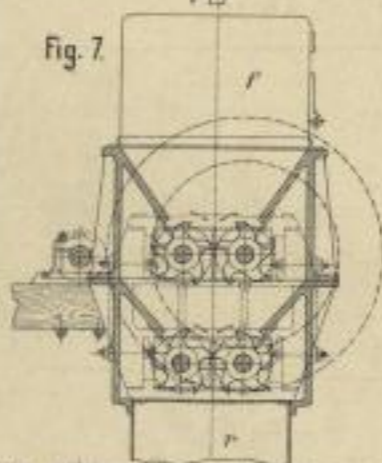

Fig. 7

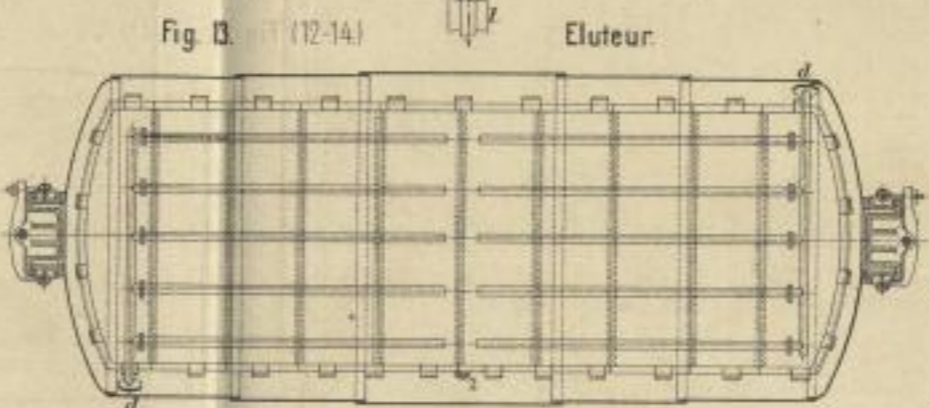

Fig. 13 (12-14)

Eluteur

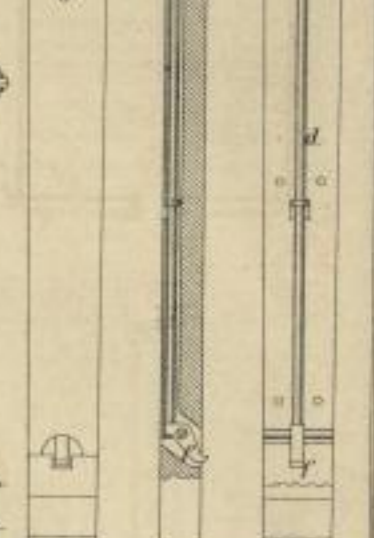

Fig. 2

Schenk's Zählvorrichtung an Meterstäben. (1-3)

Mischgefäß. (5 u. 6)

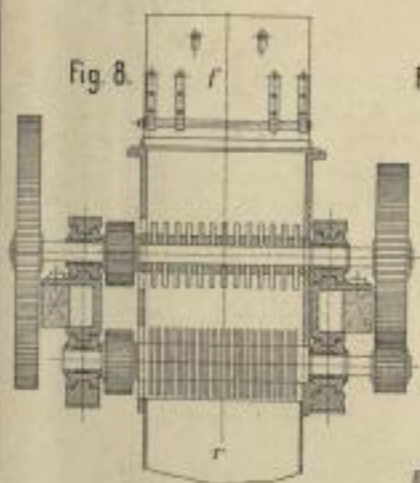

Fig. 8

Brechwerk. (7-9)

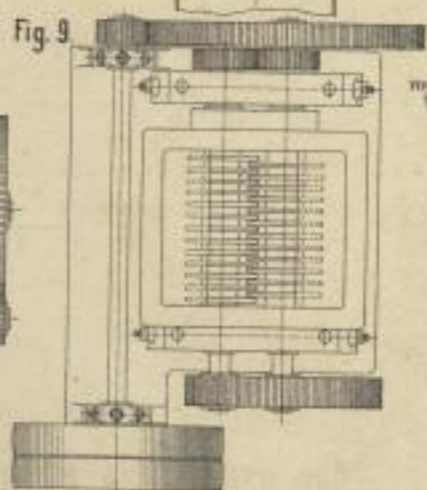

Fig. 9

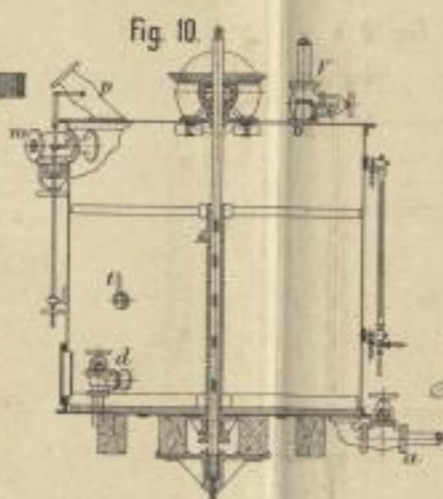

Fig. 10

Rührwerk. (10 u. 11)

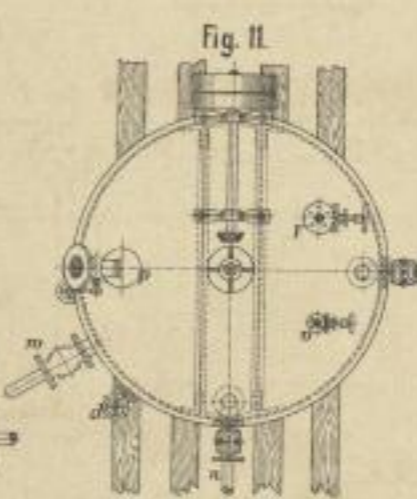

Fig. 11

Rae und Healy's telegraphischer Gegensprecher. (4)

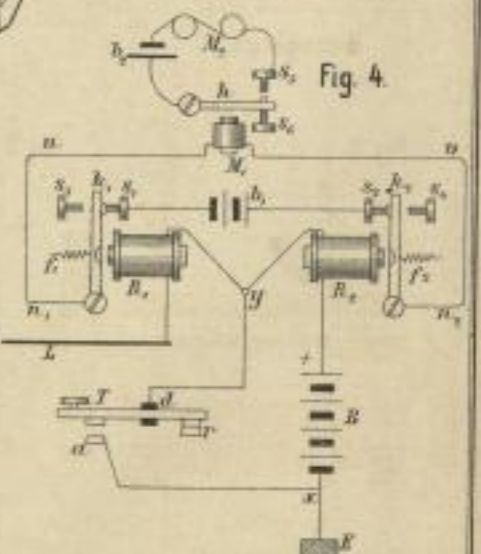
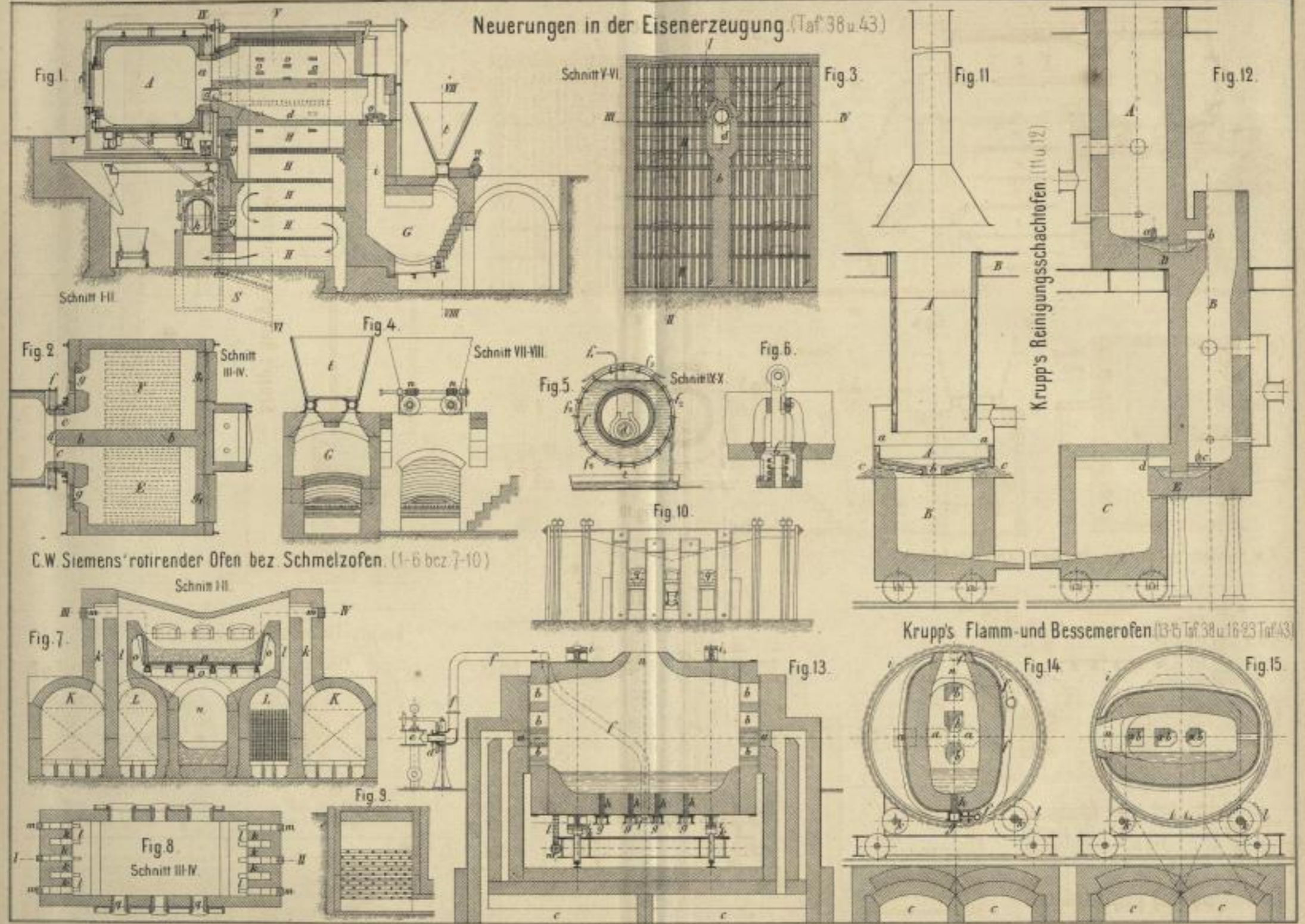

Fig. 4

18th. Anst. v. F. Wirtz, Darmstadt



### Neuerungen in der Eisenerzeugung (Taf. 38 u. 43)



C.W. Siemens' rotirender Ofen bez. Schmelzofen. (1-6 bez. 7-10)

Krupp's Flamm- und Bessemerofen (13-15 Taf. 38 u. 16-23 Taf. 43)

Krupp's Reinigungsschachtlofen (11 u. 12)

*Loth. Ansicht v. Filter, Thurnwald*





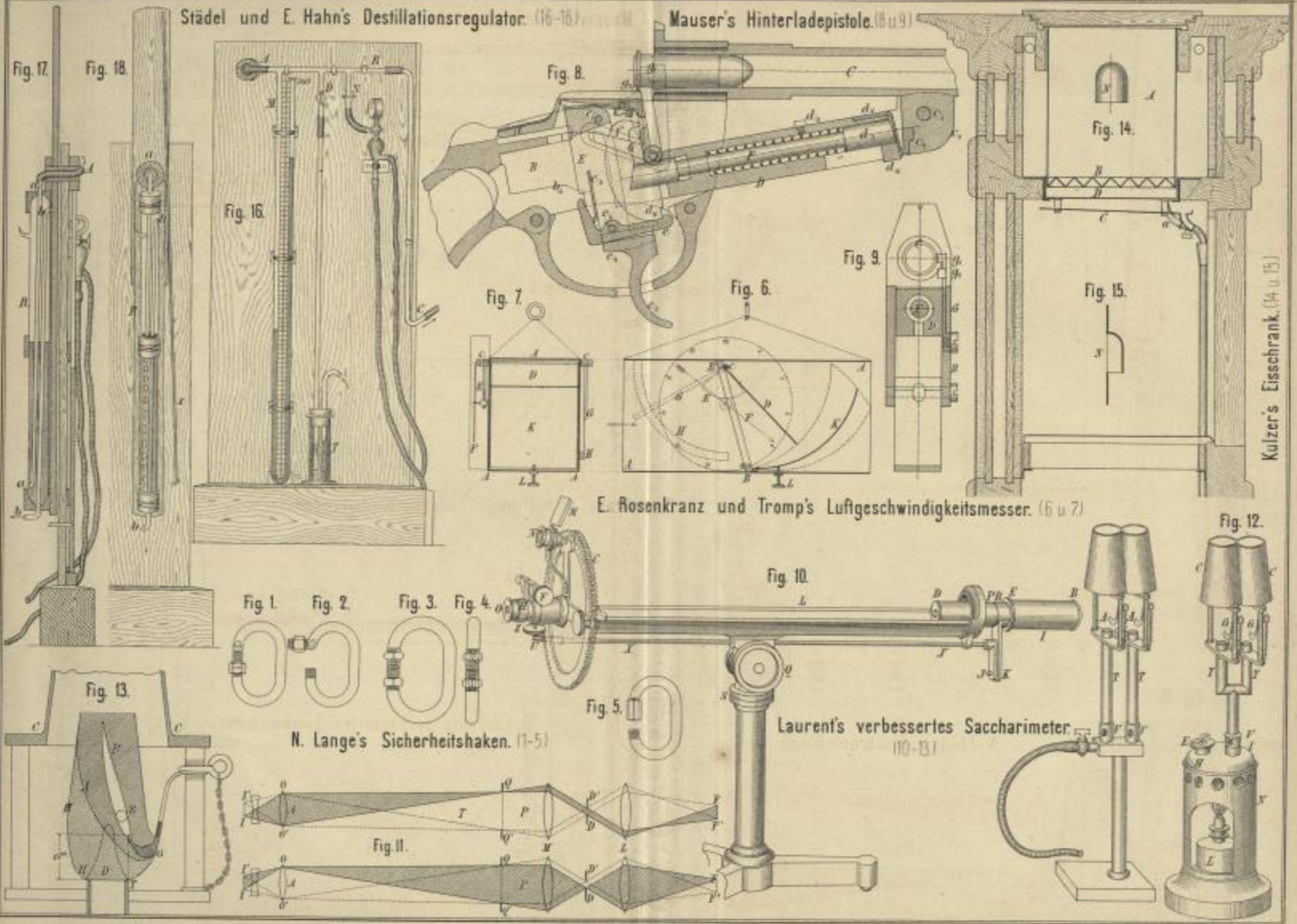

Lith. Anst. v. F. Wille, Darmstadt.



Halpin's Expansionssteuerung. (1-5)

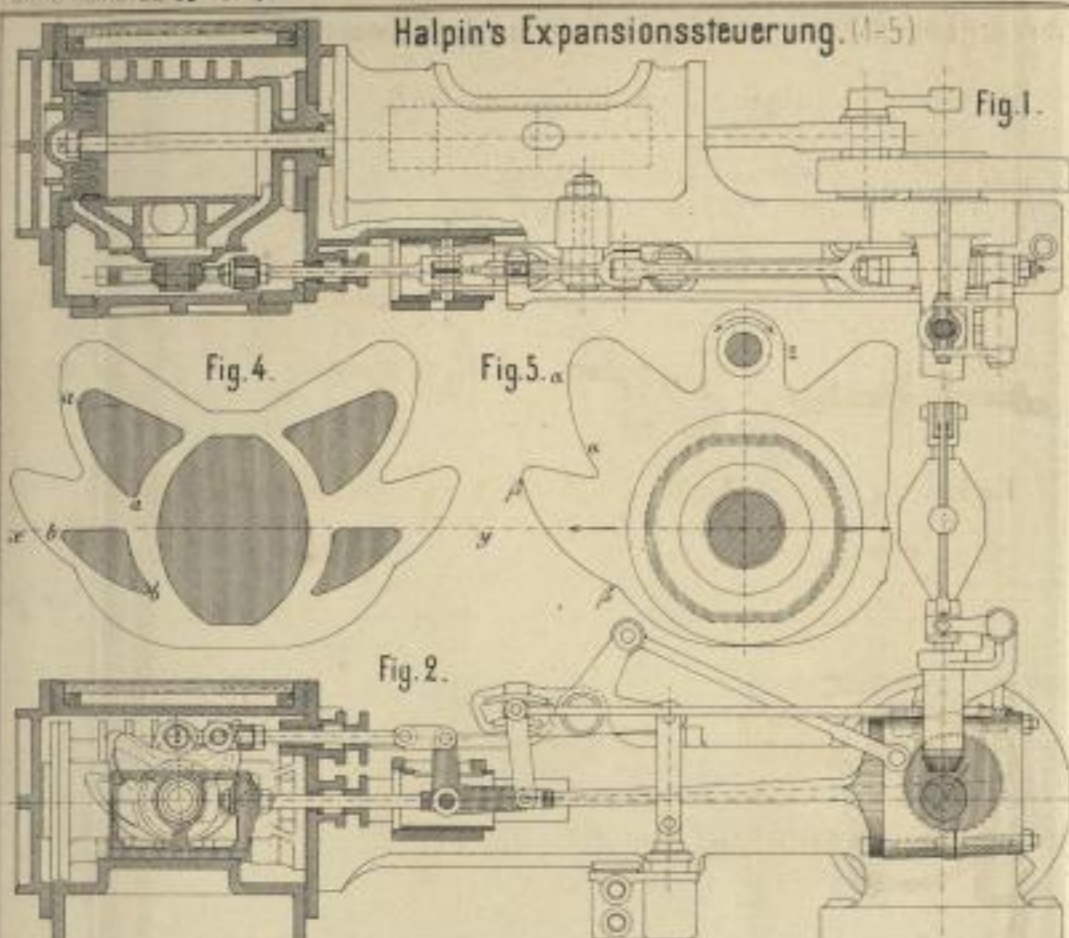

Rondi's Reibräder. (6-10)

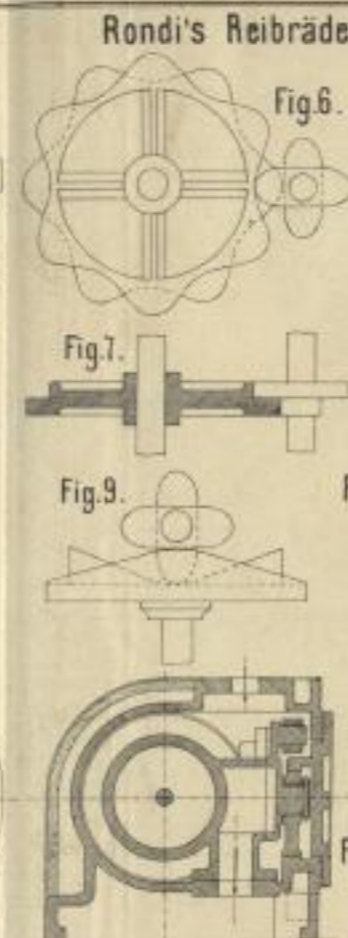

Strube's Druckregulator. (11)

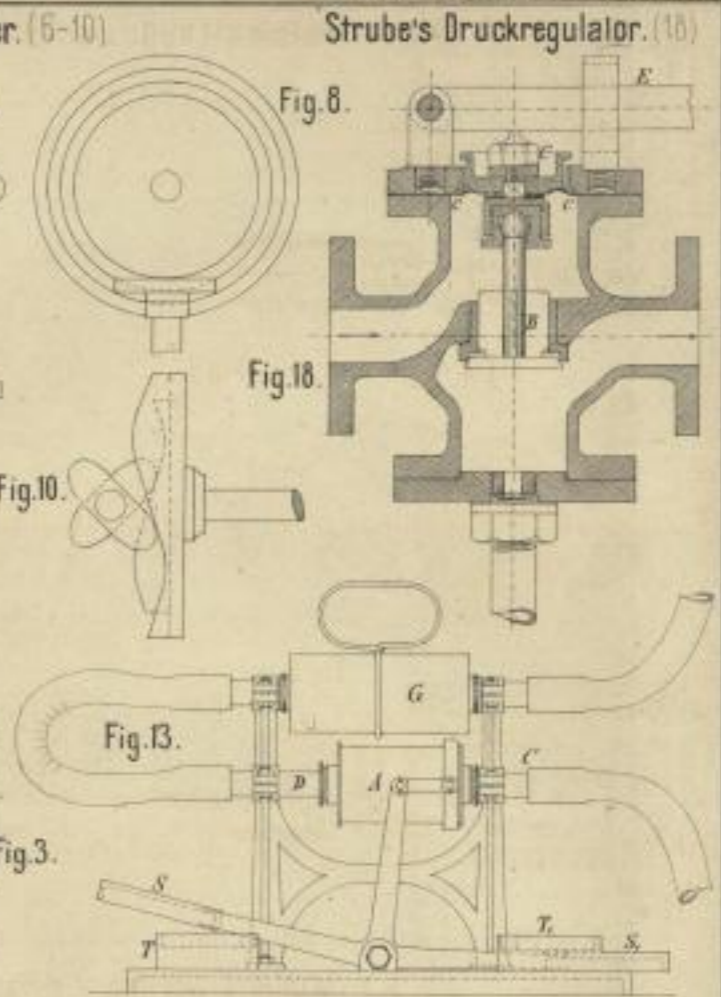

K.G. Müller's Spritze für Hand- und Fussbetrieb. (11-17)

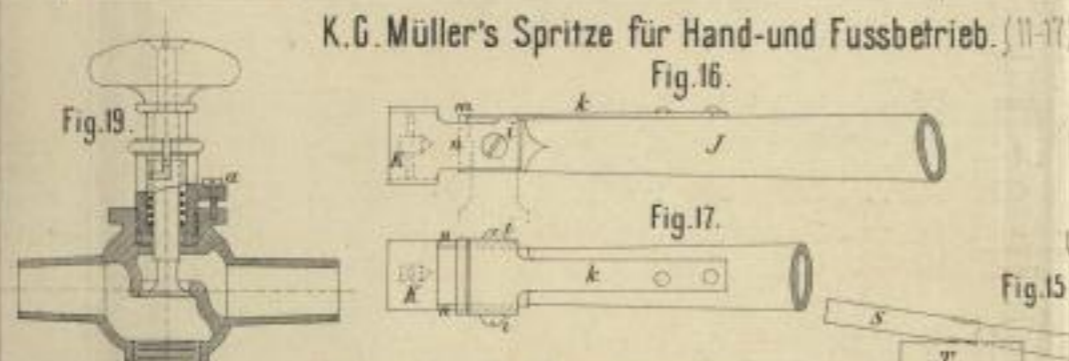

Semmelroth's Durchlassventil. (19)

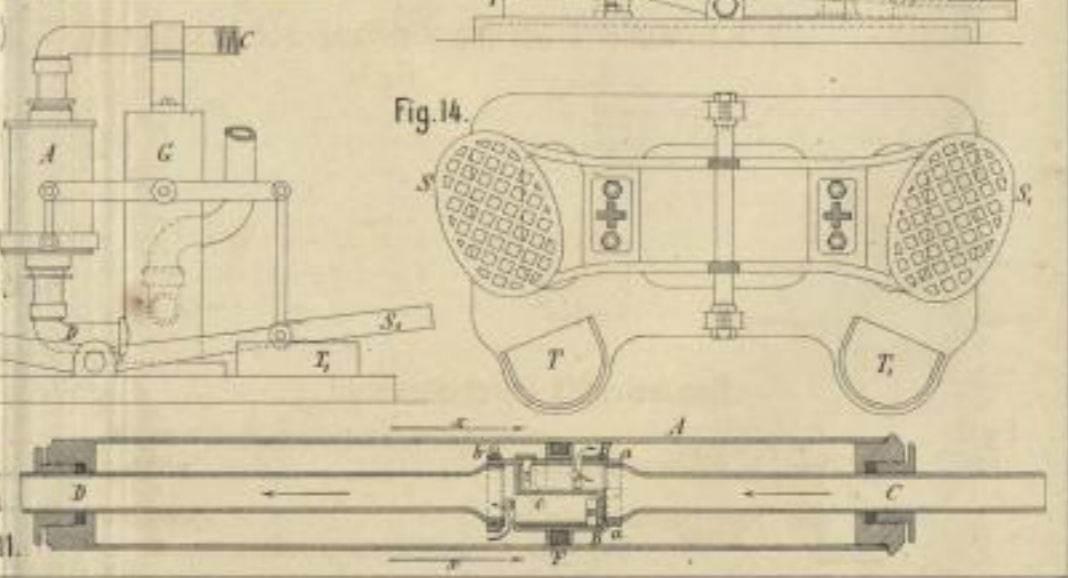
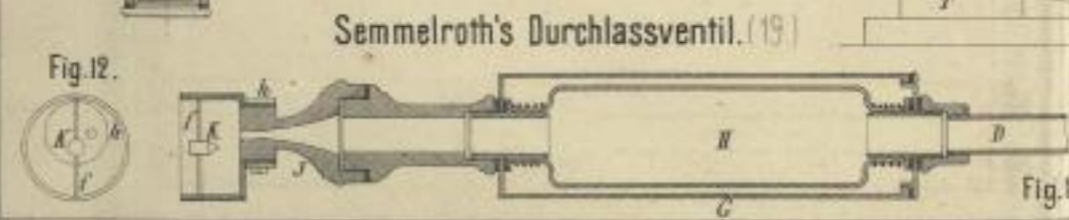

(Nach Annalen von F. Wirtz, Darmstadt.)



Chr. Mann's Luftcompressionsapparat. (17)

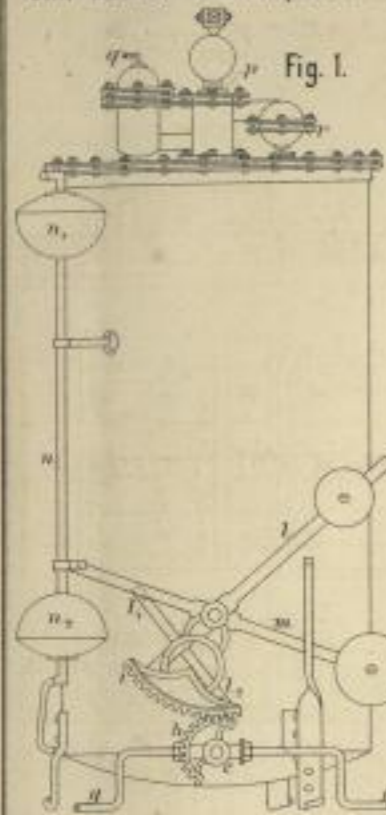

Fig. 1.

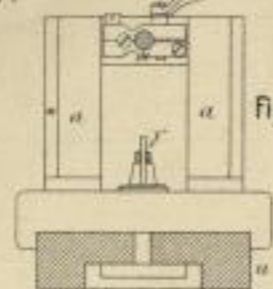

Fig. 5.

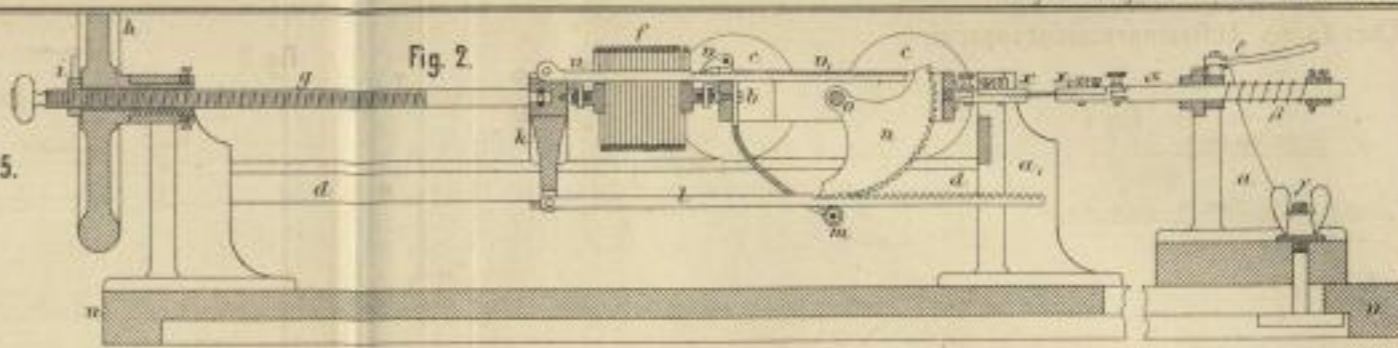

Fig. 2.

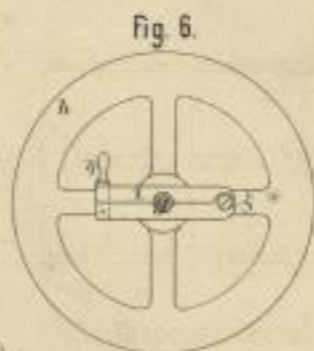

Fig. 6.

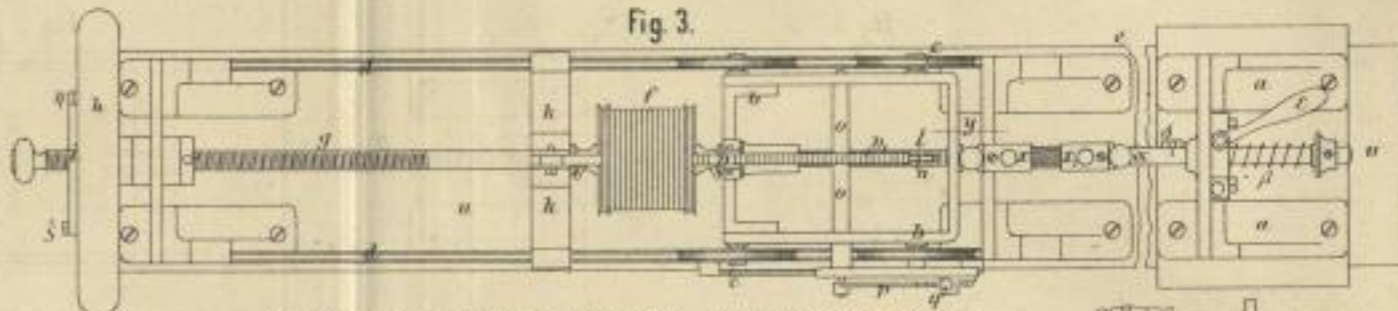

Fig. 3.



Fig. 8.

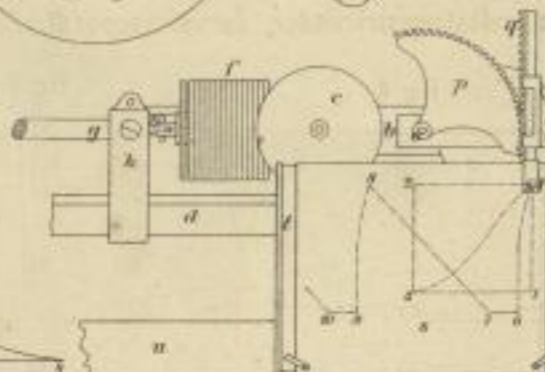

Fig. 4.

Reusch's selbstregistrierender Zerreißapparat. (2-8)

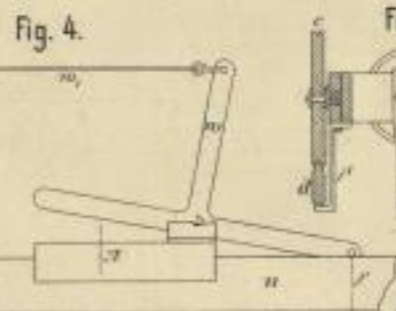

Fig. 7.

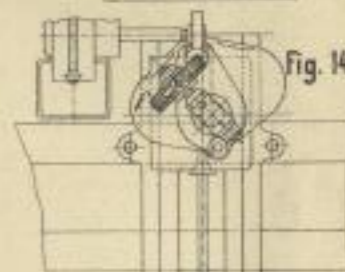

Fig. 14.

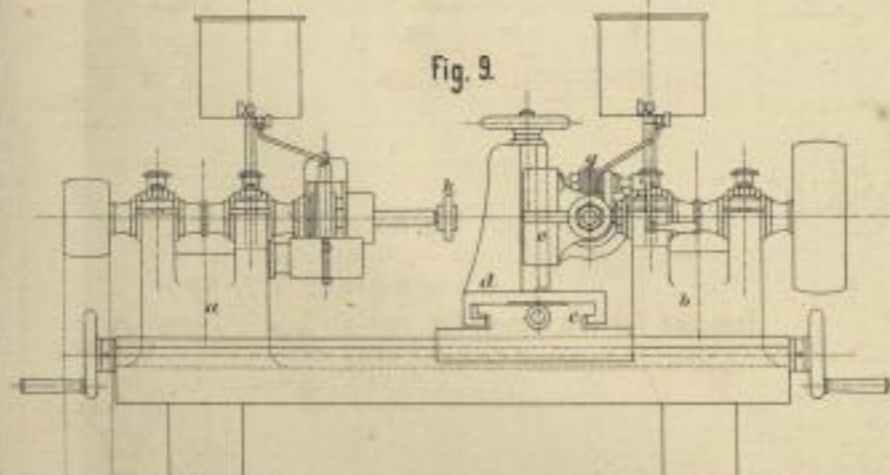

Fig. 9.

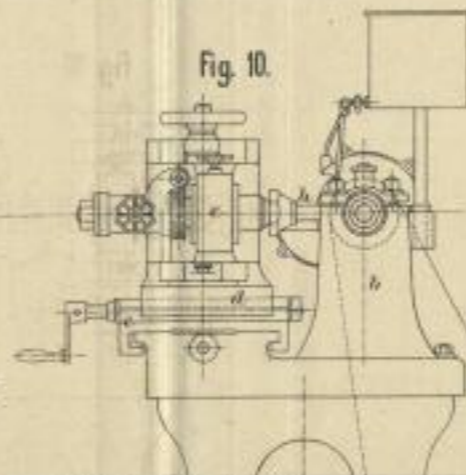

Fig. 10.

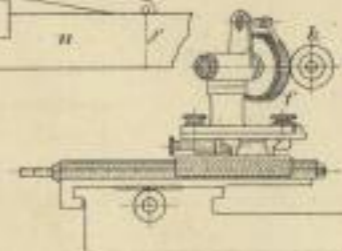

Fig. 12.

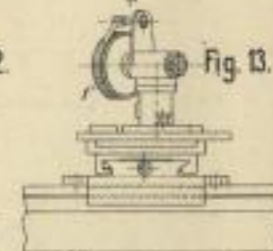

Fig. 13.

Fräs- und Schleifmaschine für Spiral-Lochstempel. (9-14)

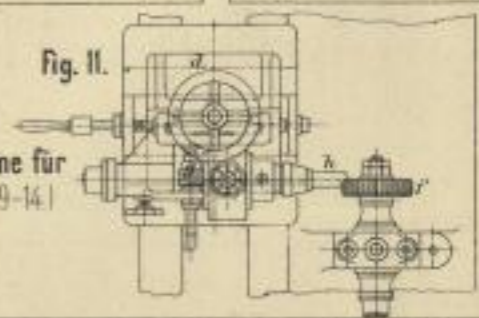
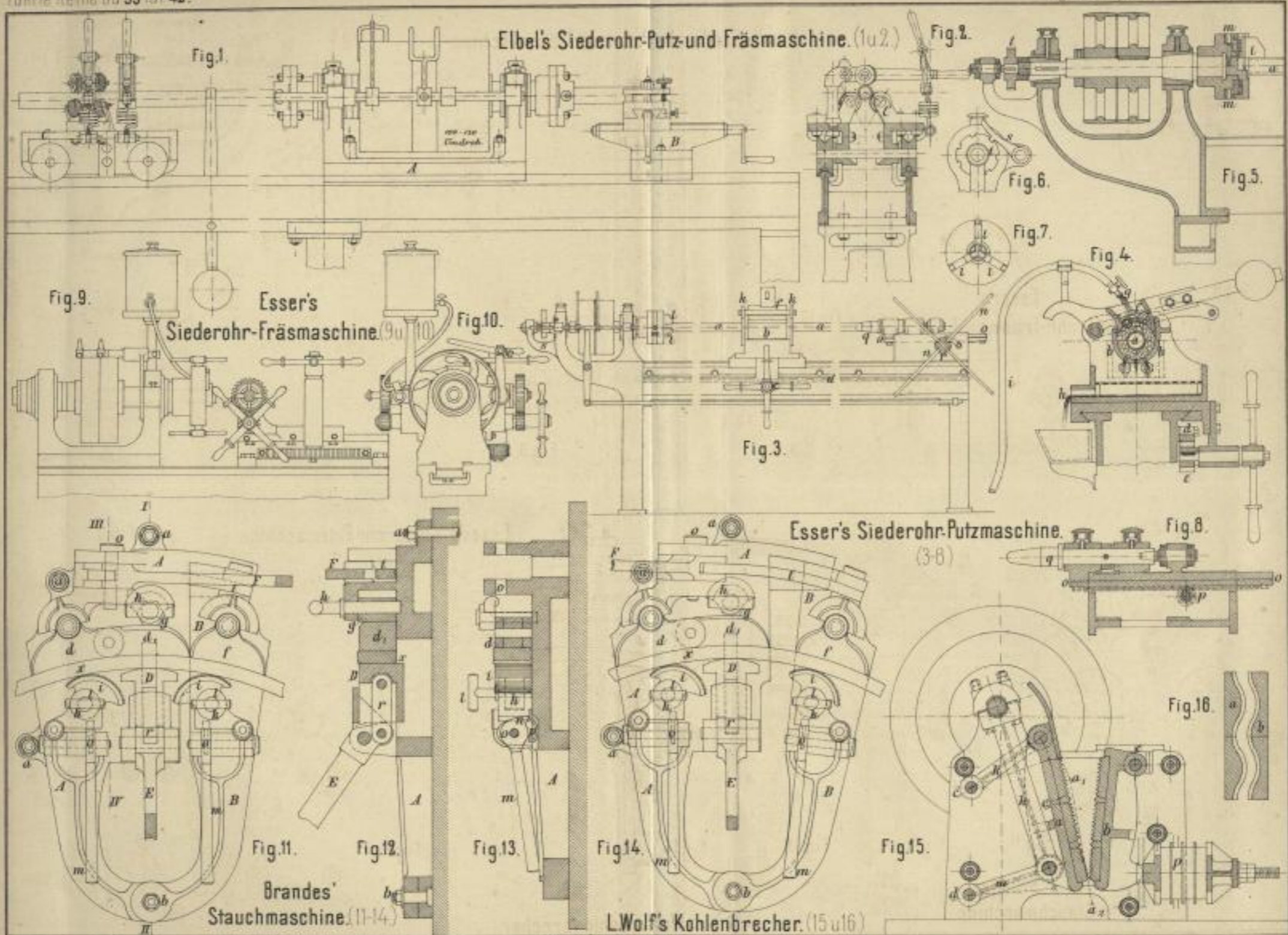

Fig. 11.

Zeich. Anst. v. J. Witt, Darmstadt.







Tech. Anst. v. F. W. v. W. Darmstadt.





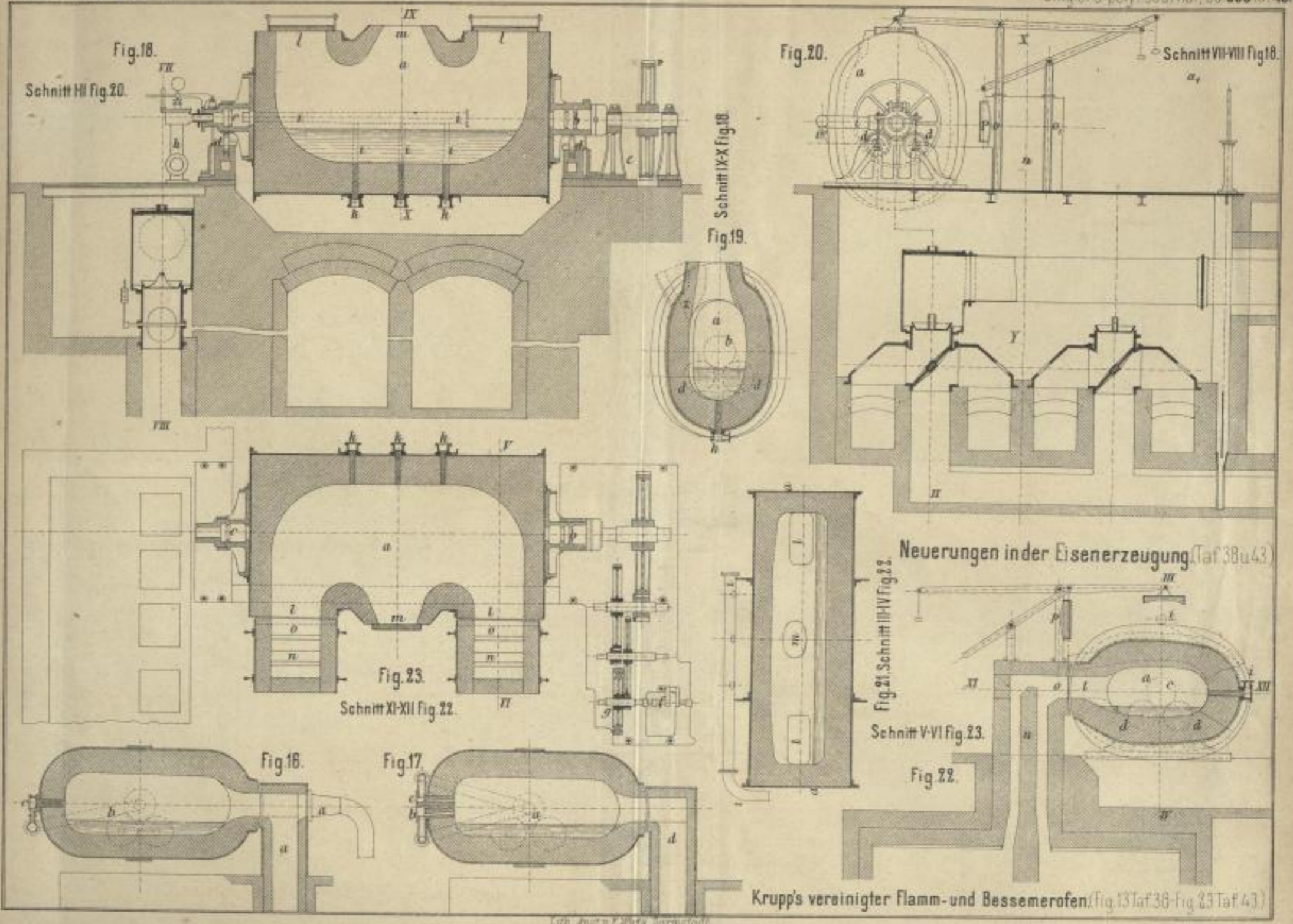

Neuerungen in der Eisenerzeugung (Taf. 38 u. 43)

Krupp's vereiniger Flamm- und Bessemerofen (Fig. 13 Taf. 38 - Fig. 23 Taf. 43)

Lith. Anst. v. F. W. G. Jarmstadt



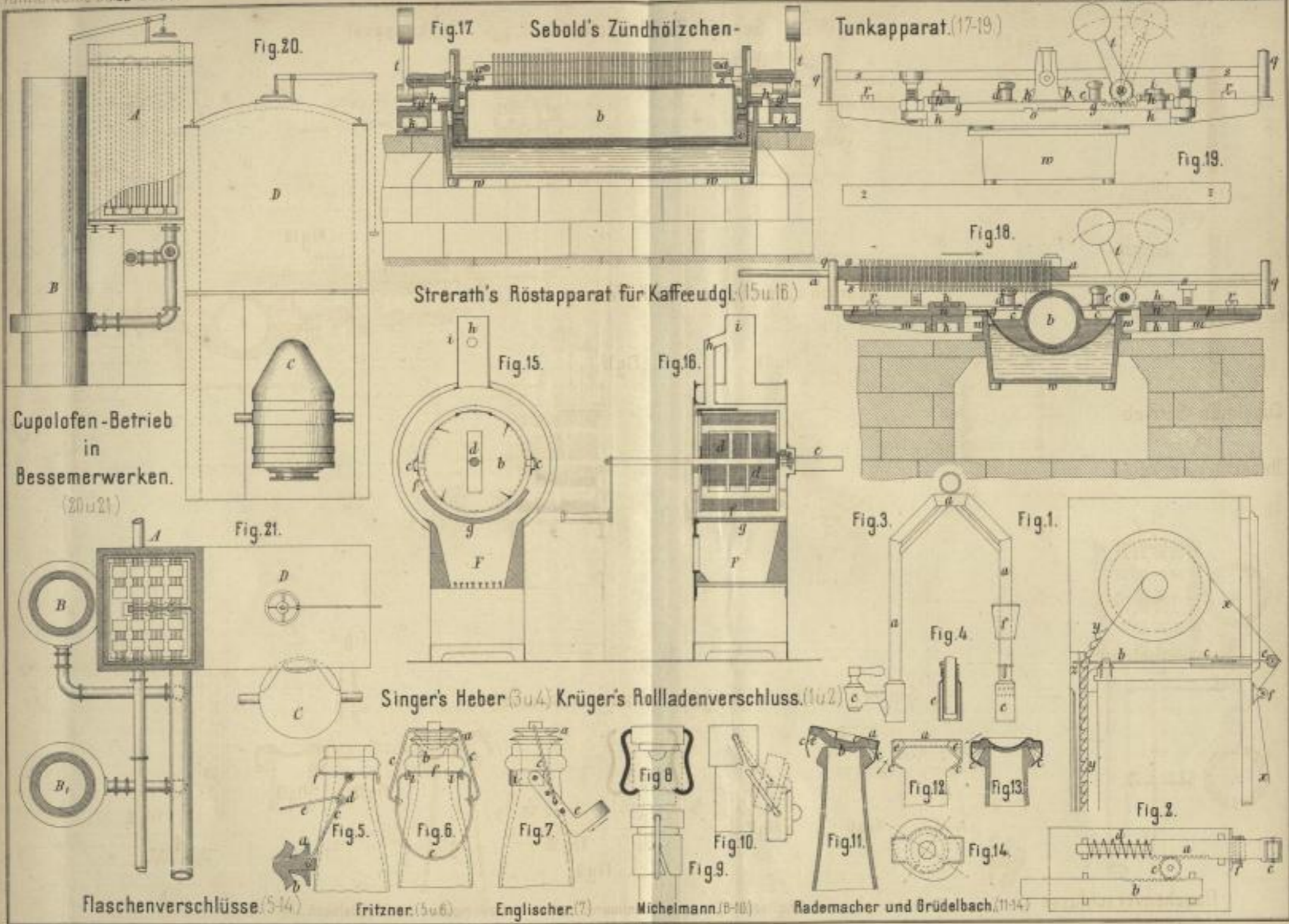

Cupolofen-Betrieb in Bessemerwerken. (20 u. 21)

Fig. 17. Sebold's Zündhölzchen-

Tunkapparat. (17-19)

Strerath's Röstapparat für Kaffeedgl. (15 u. 16)

Flaschenverschlüsse (5-14)

Fritzner. (5 u. 6)

Englischer. (7)

Michelmann. (8-10)

Rademacher und Brüdelbach. (11-14)

Singer's Heber (3 u. 4) Krüger's Rollladenverschluss. (1 u. 2)

Lith. Anst. v. E. Wörke, Darmstadt.





Sächs.  
Landes-  
Bibl



















~~Heinzelmaier  
Buchbinder  
DRESDEN~~

Techn. A. 264



SLUB DRESDEN



3 2422803