

























**A t l a s**

zu

**Dingler's polytechnisches Journal.**

**Band 234.**

(Sechzigster Jahrgang.)

**Jahrgang 1879.**

---

Enthaltend 38 lithographirte Tafeln.



**Augsburg.**

Druck und Verlag der J. G. COTTA'schen Buchhandlung.

24954



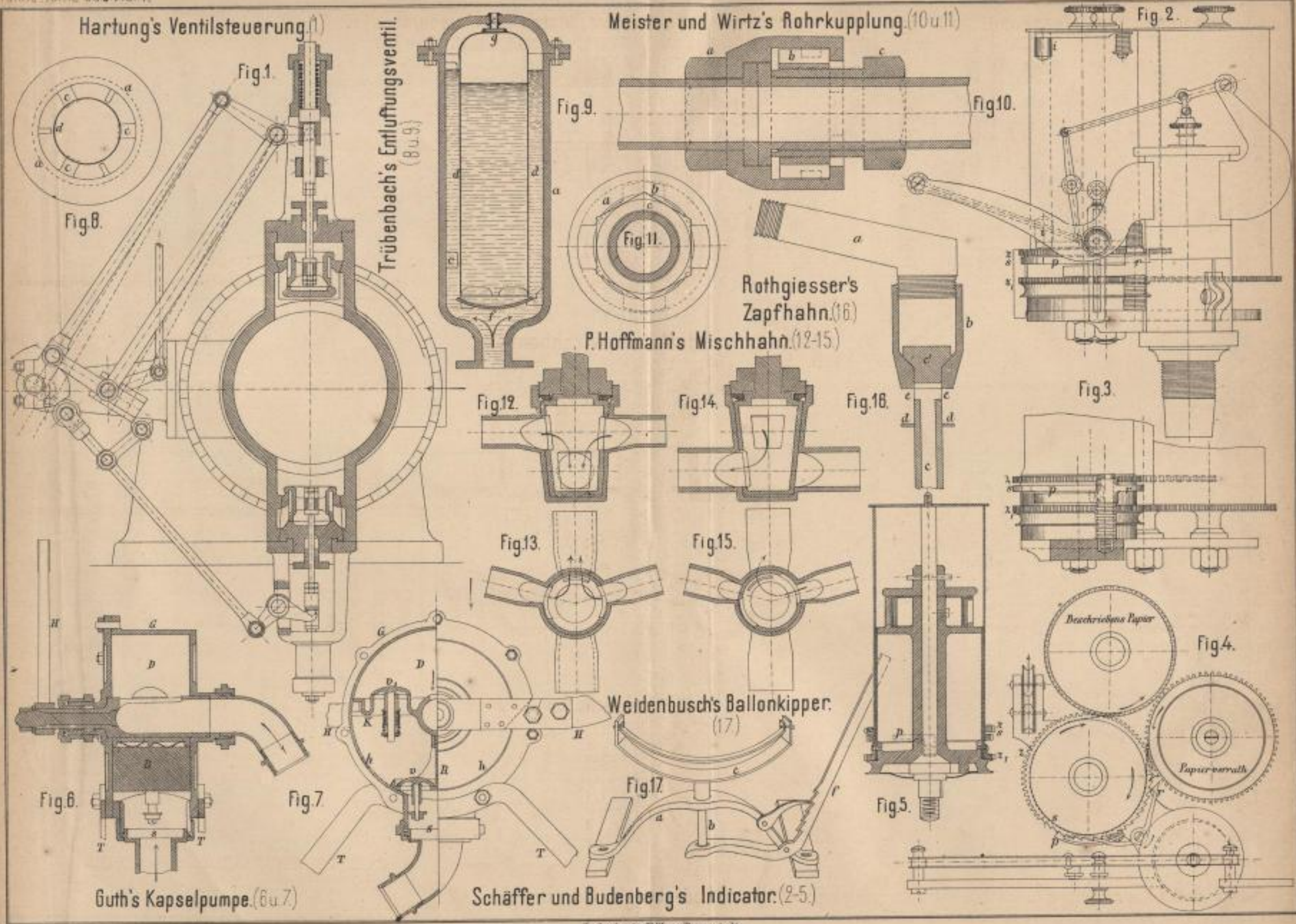

Lith. Anst. v. F. Wirtz Darmstadt.



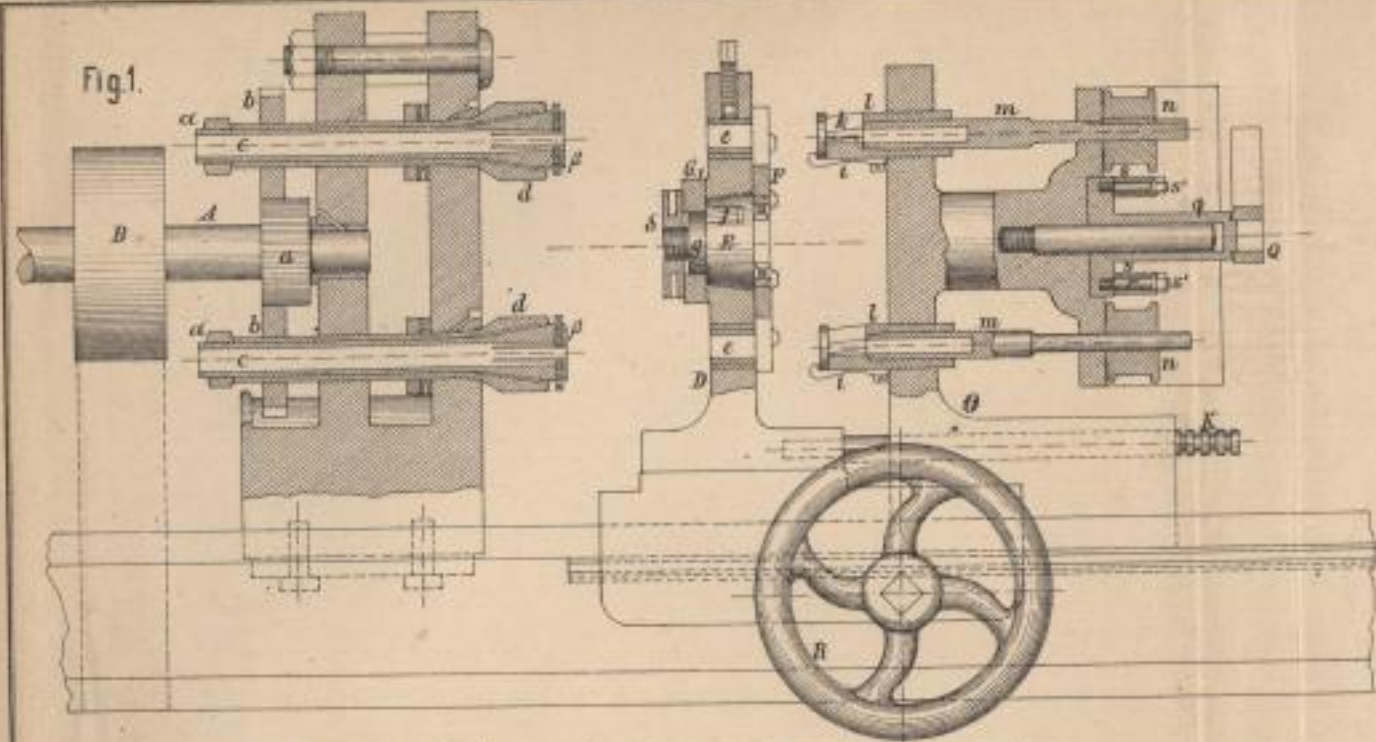

Fig. 3.

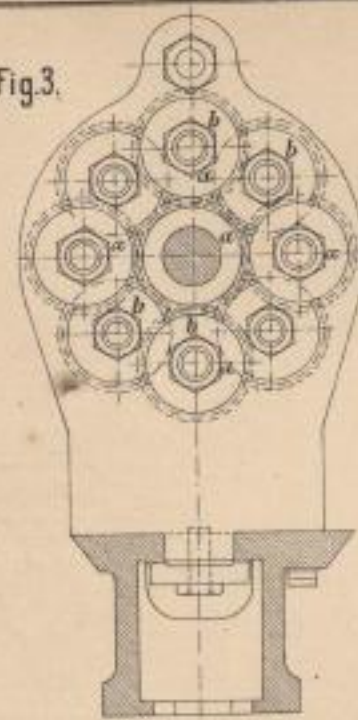

Fig. 7.

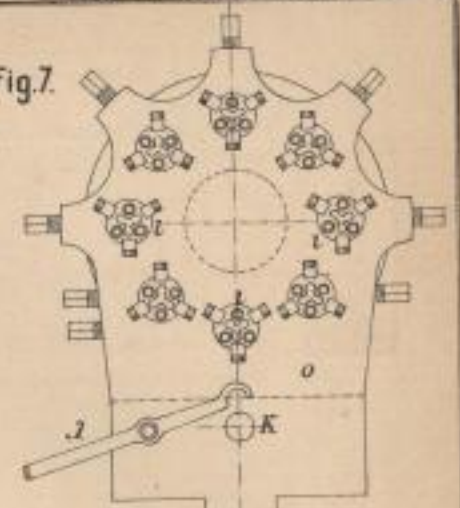

Fig. 4.

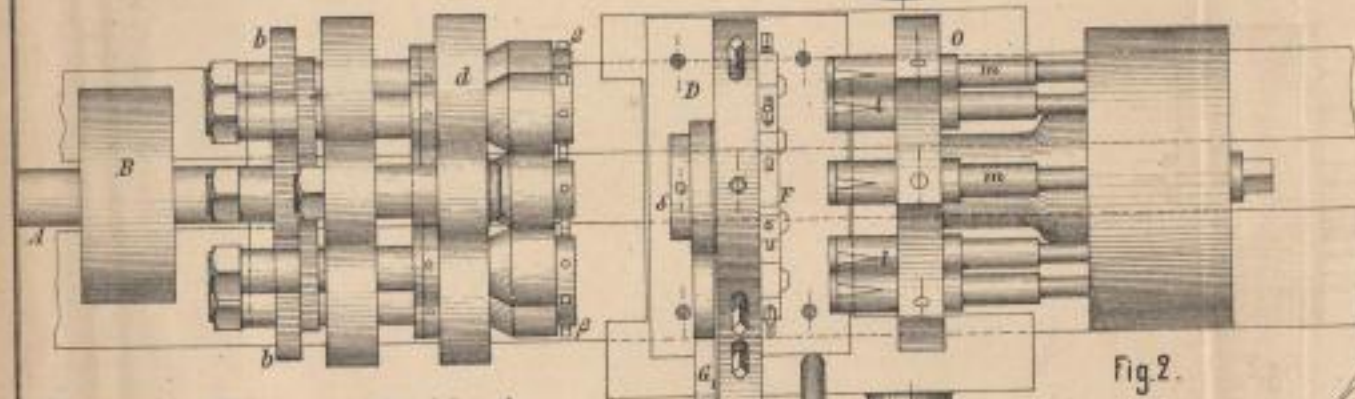
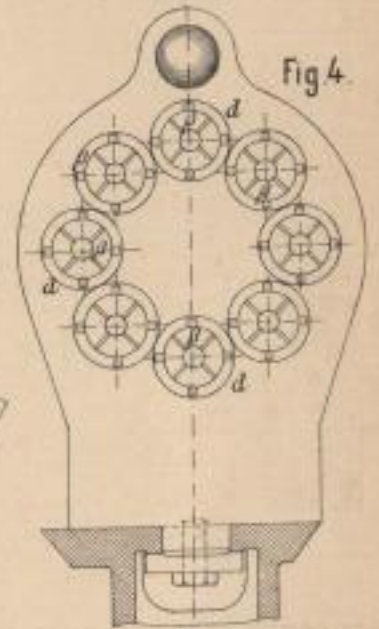
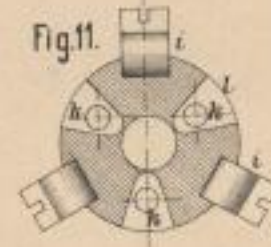

Fig. 2.

Fig. 10.



Fig. 11.



O. Bourset's Schrauben-Drehbank.  
(1-11.)

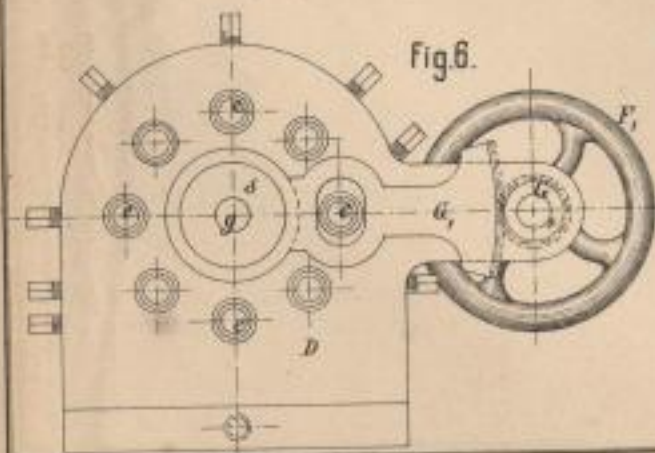

Fig. 6.

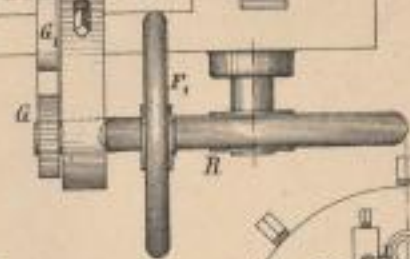
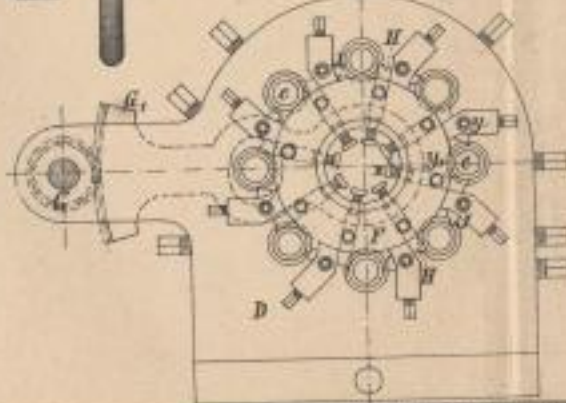

Fig. 5.



Lith. Anst. v. F. Witz, Darmstadt.

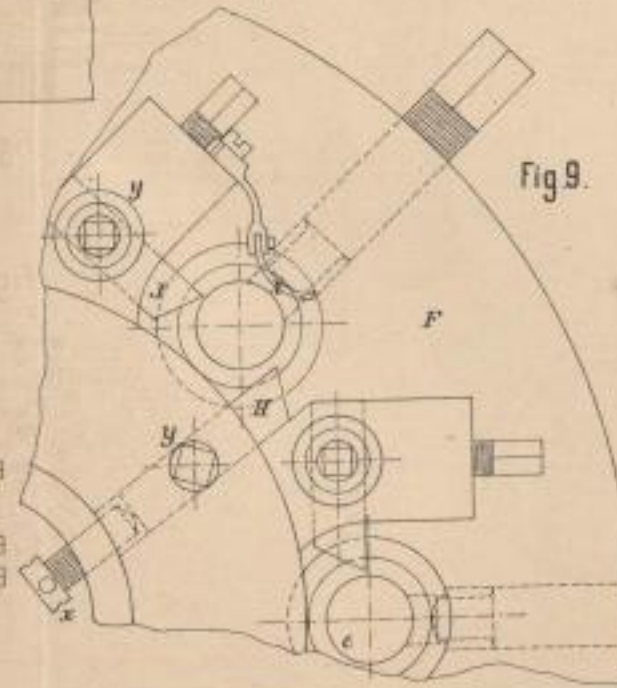

Fig. 9.

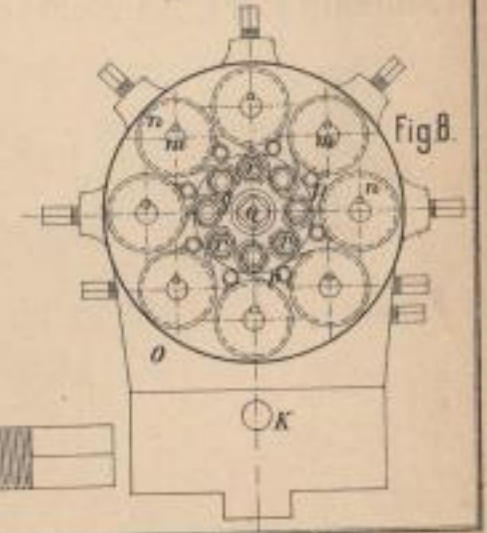
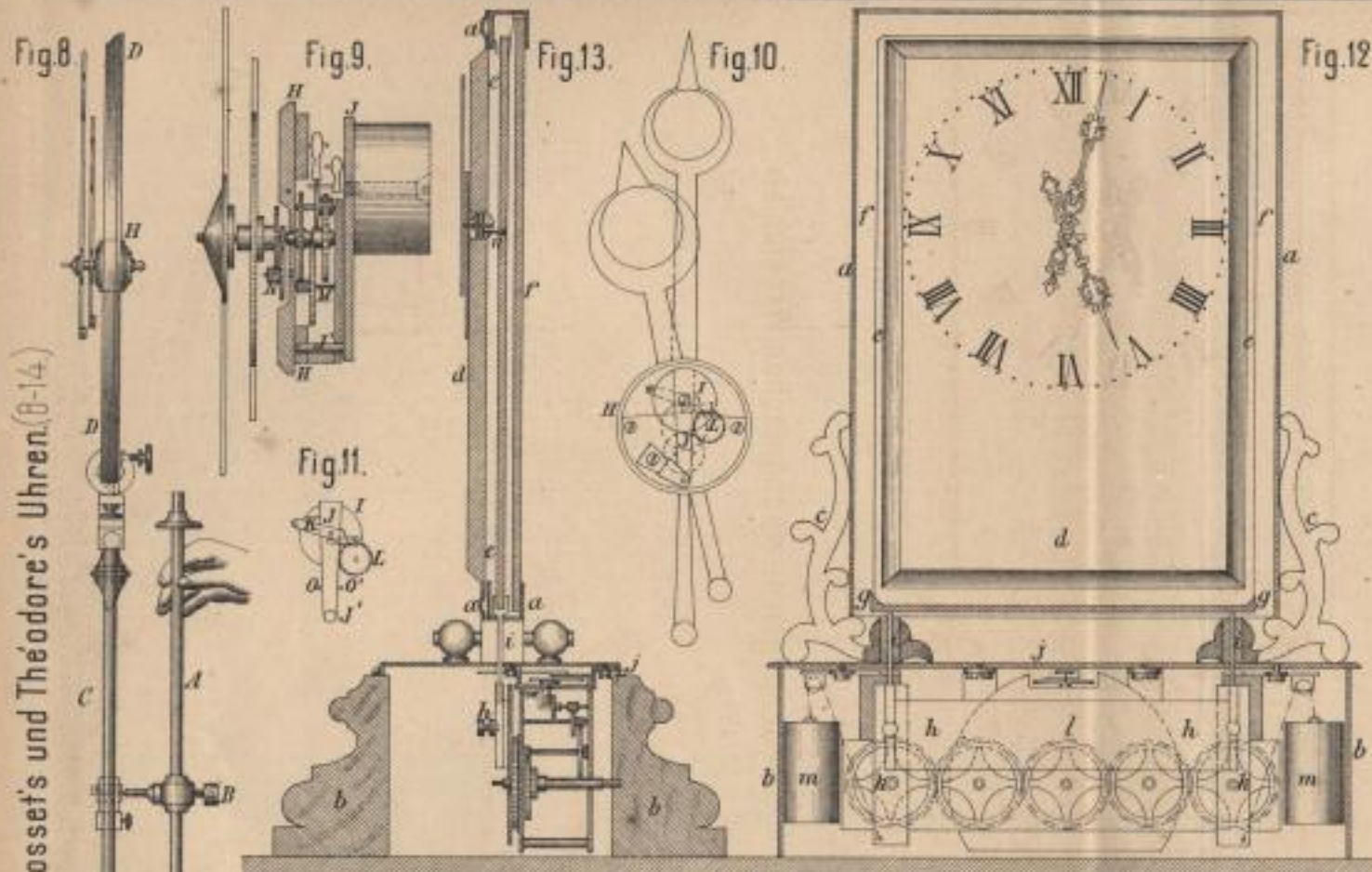

Fig. 8.



Rosset's und Théodore's Uhren. (8-14.)



Neuerungen an mechanischen Webstühlen. (2-7.)

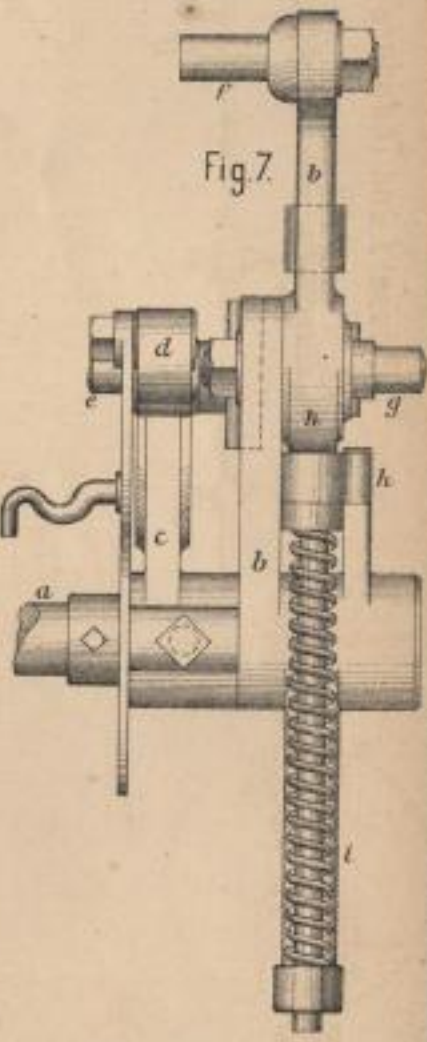
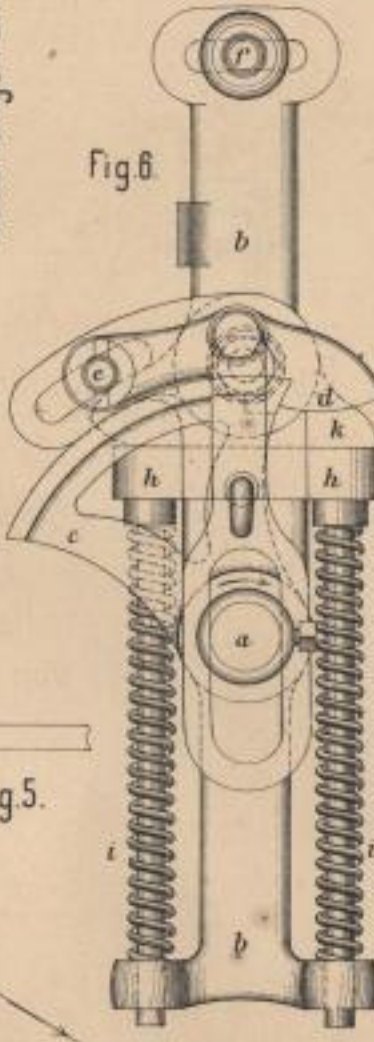
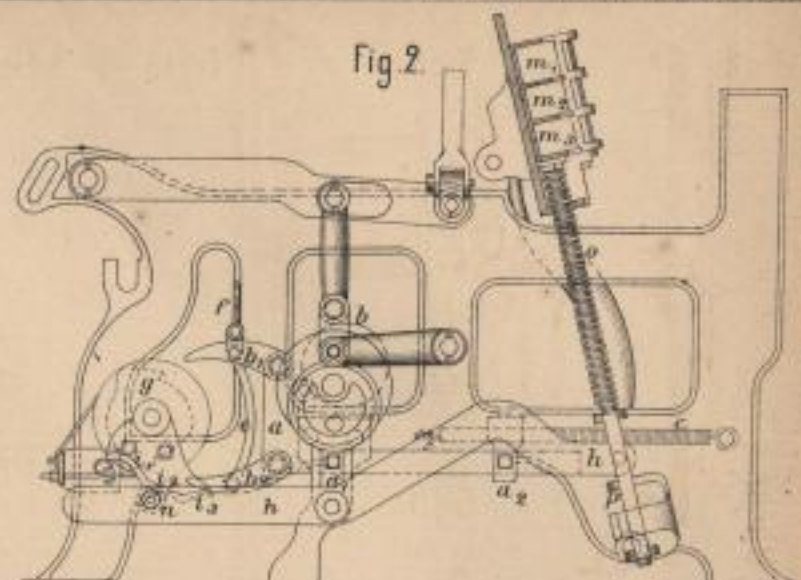

Fanchamps' Fadenwächter. (1.)

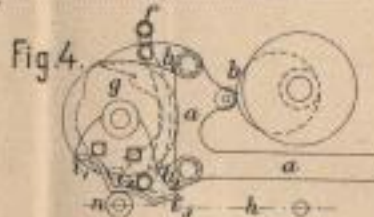
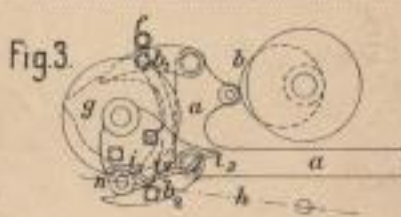
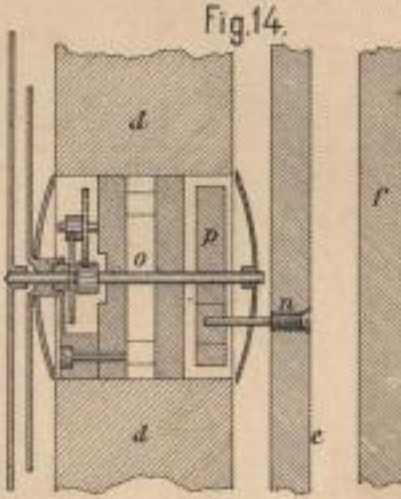
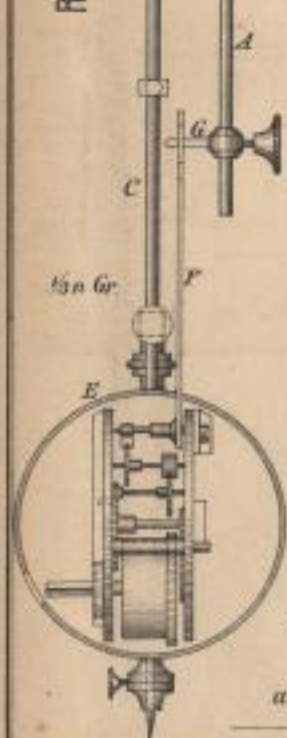

F. Hess' Untersuchung von Explosivstoffen. (15)

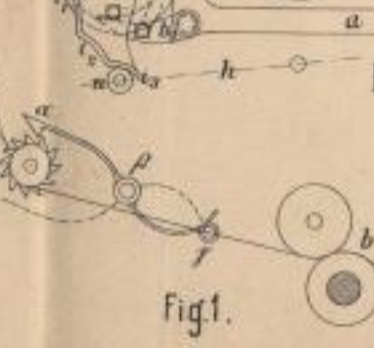
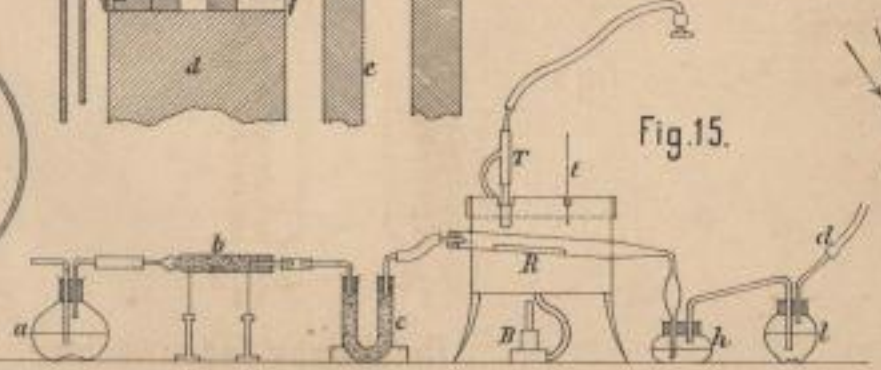

Lat. Anst. v. F. Werke Darmstadt.



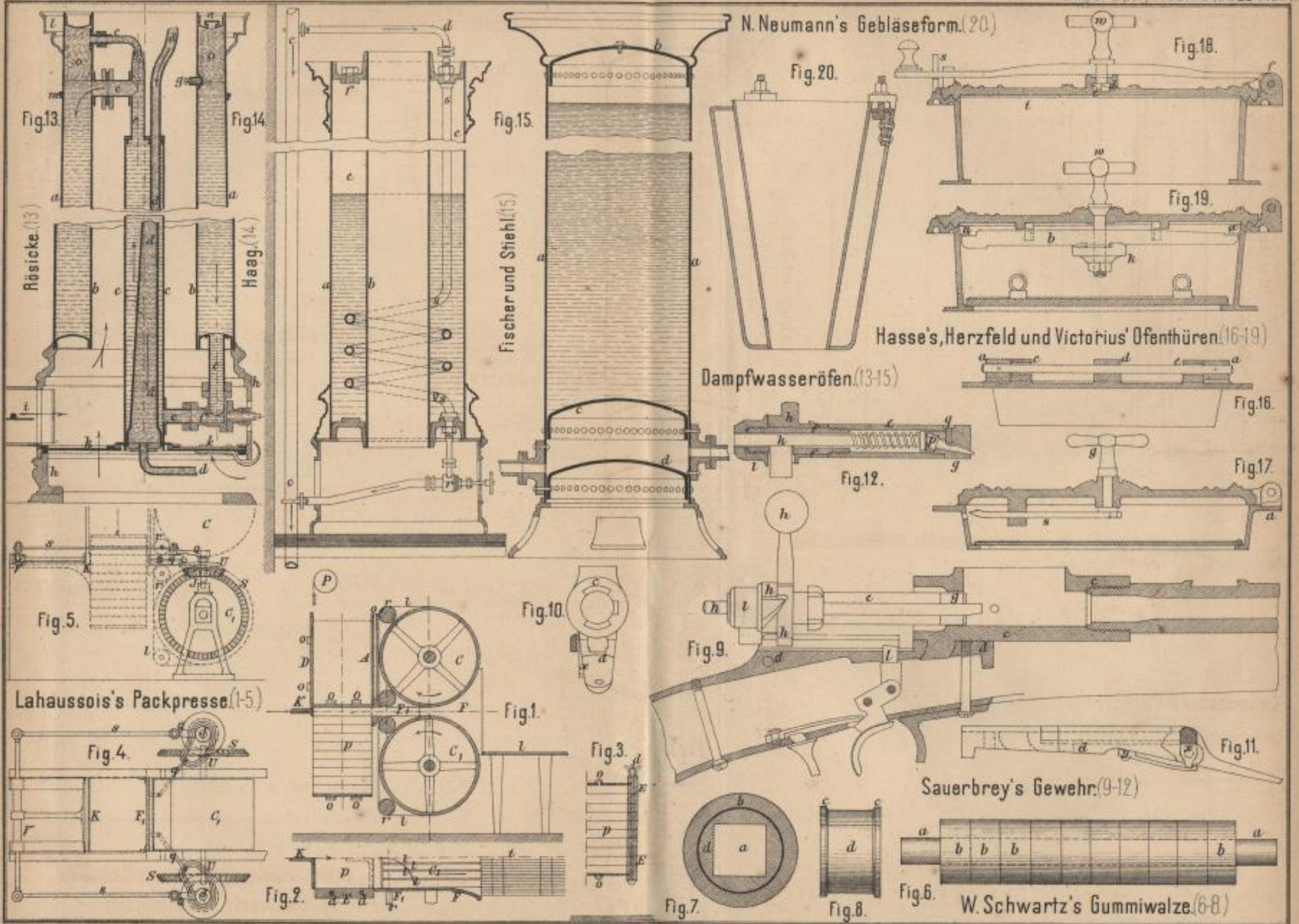

Lith. Anst. v. F. Witt. Darmstadt.



O Schott's Jodbestimmung (9.)

Rack's Dampf- und Uebergussapparat (5 u. 6.)

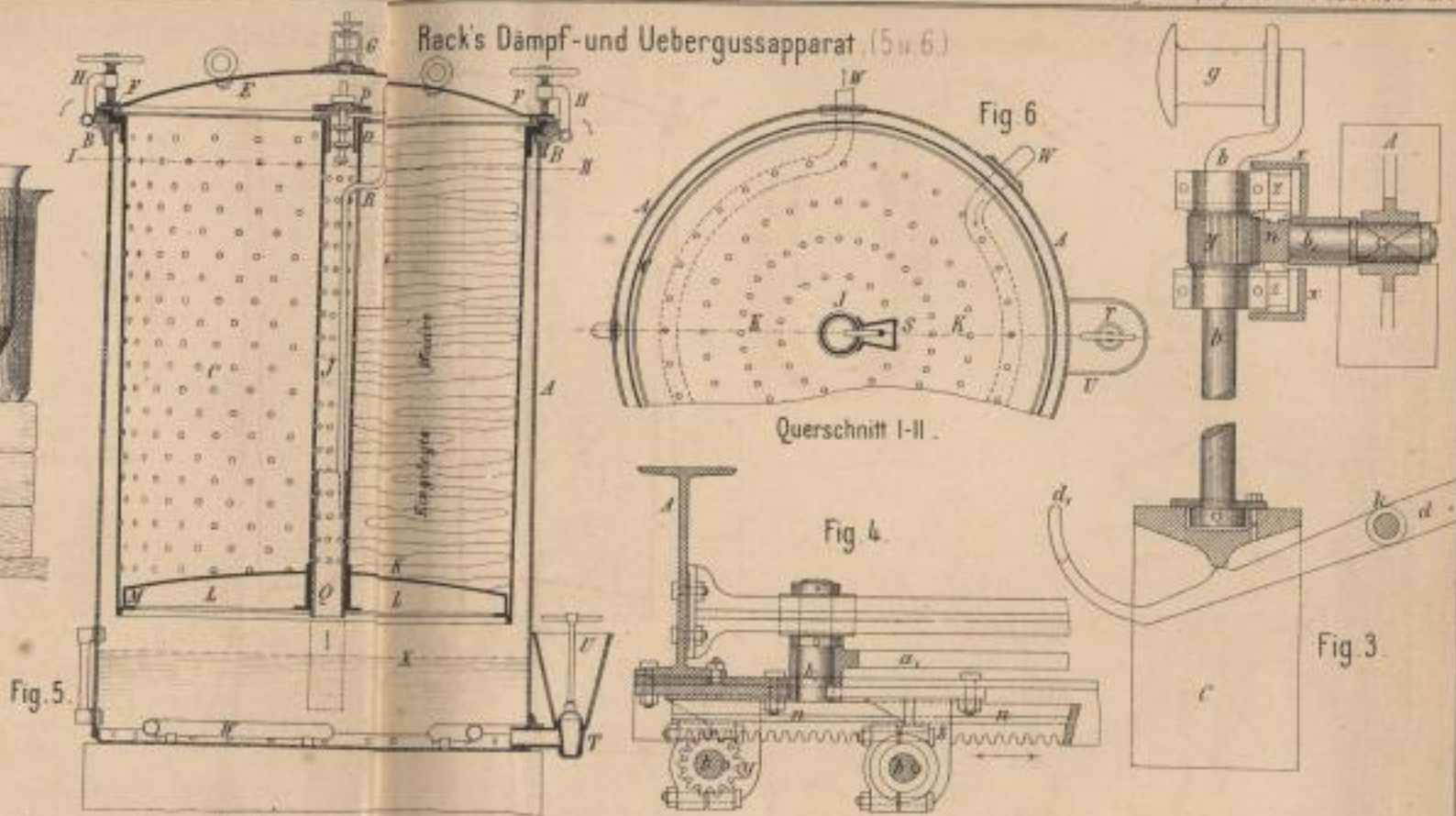
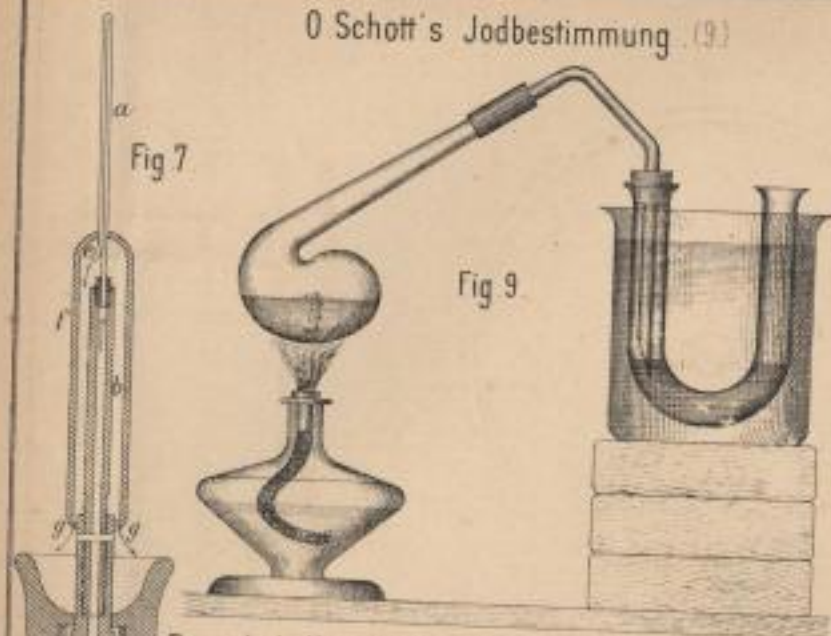

Paquelin's Verbrennungsapparat (7.)

Köhler's Bestimmung der Löslichkeit (8.)

Berchold's Chevillirmaschine (1-4.)

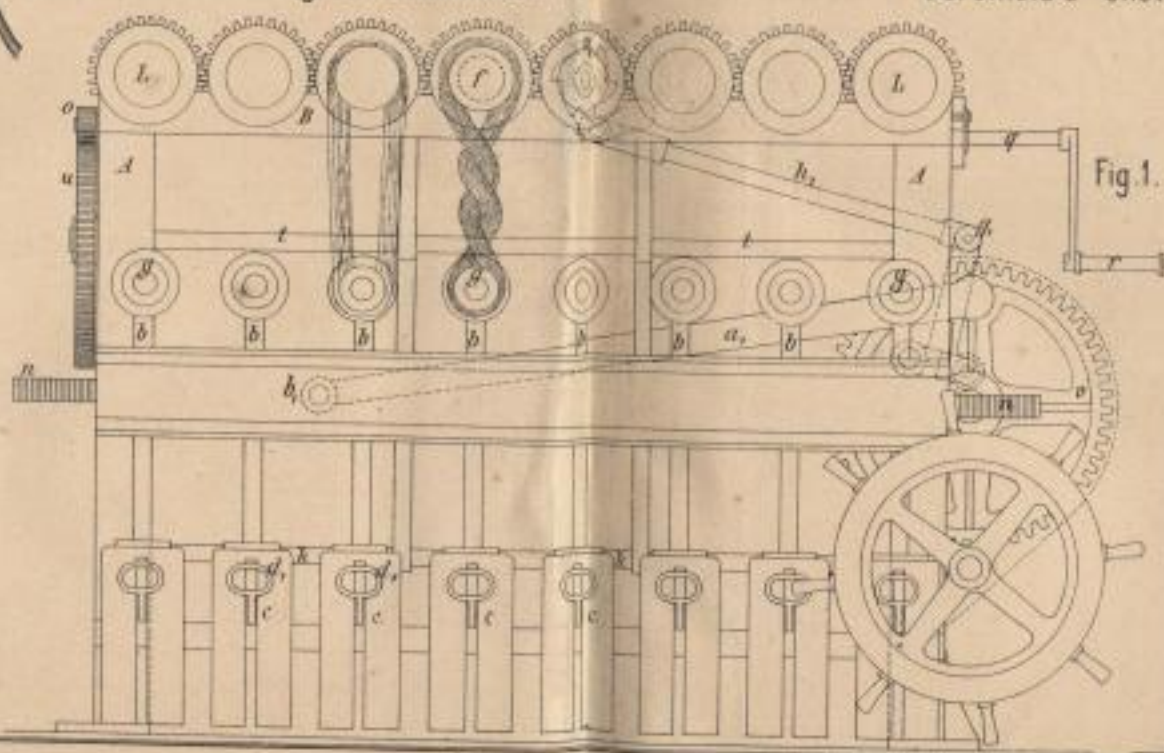
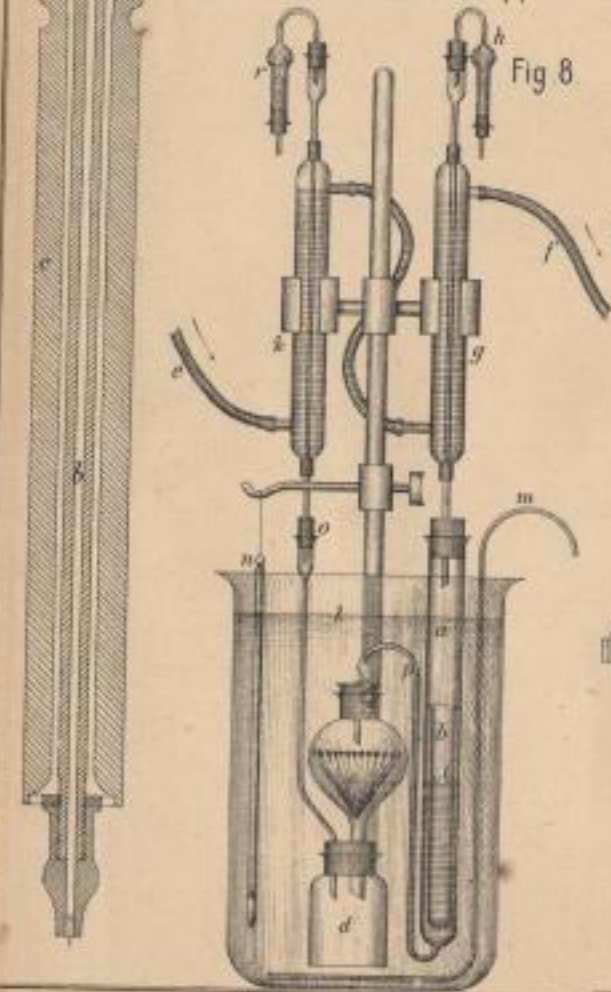

Lith. Anst. v. F. F. Darmstadt



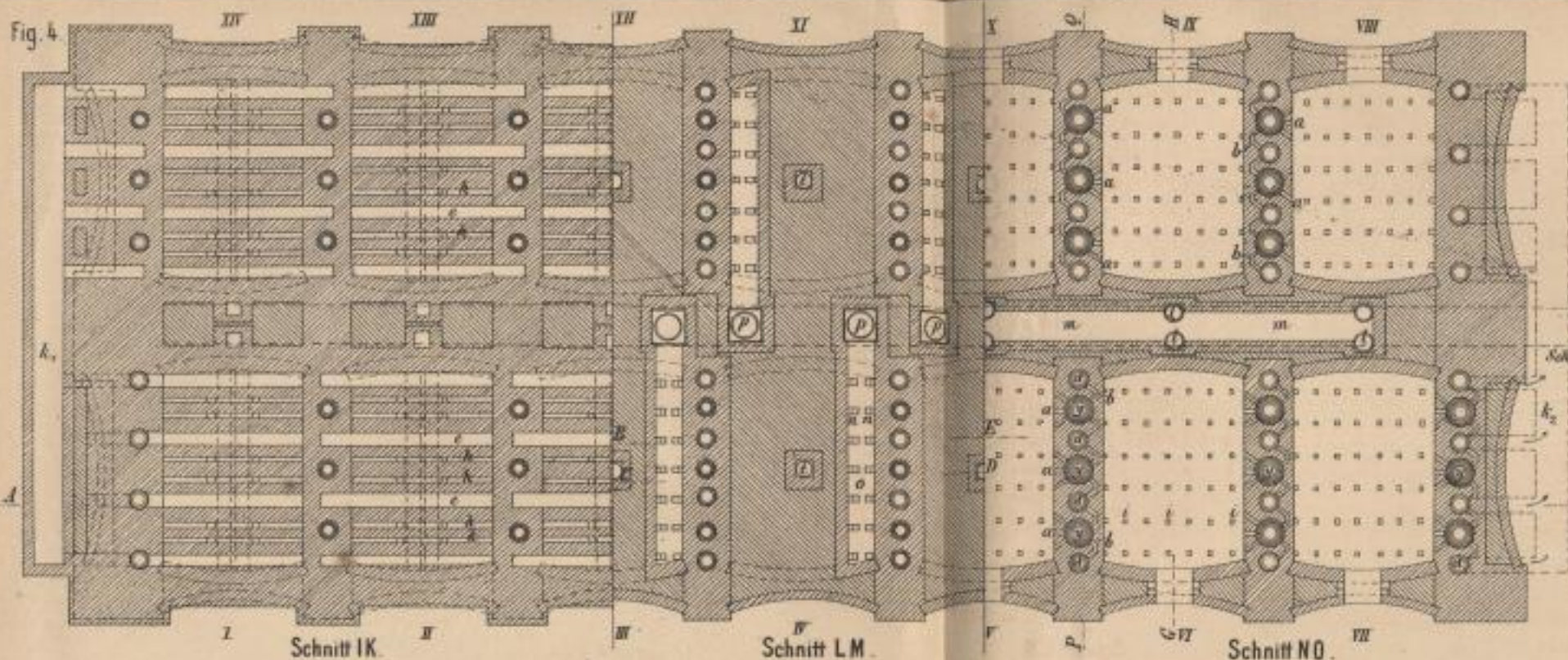

Schnitt AB. Künne's Gasfeuerung für Ringöfen (1-3) Schnitt CD.

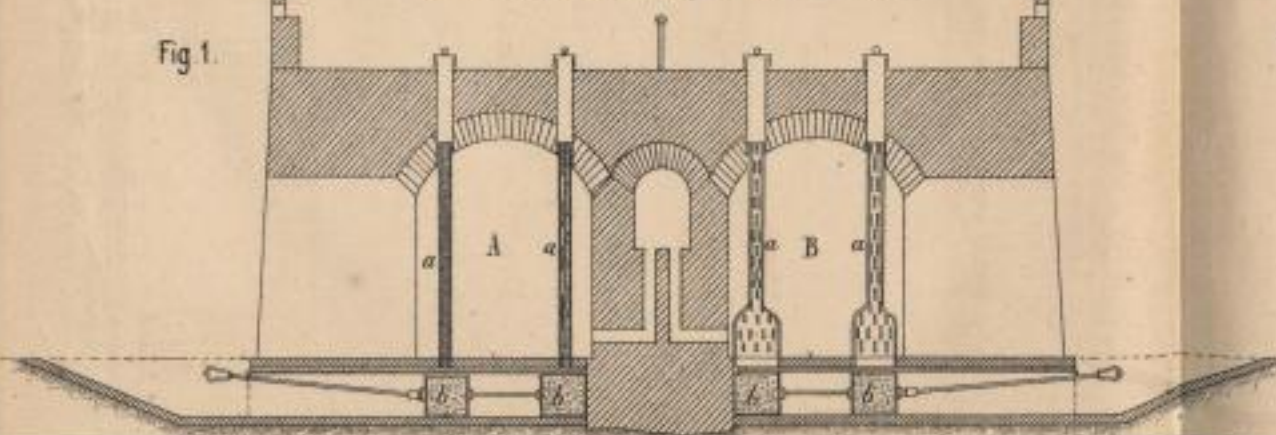

Fig. 1.

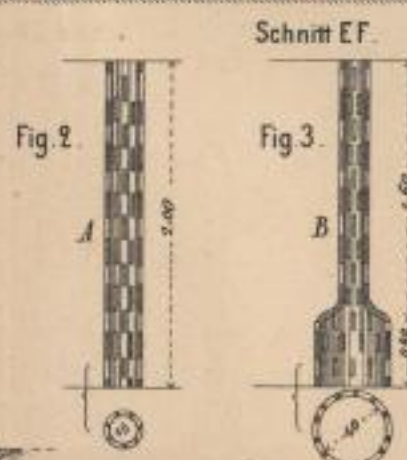

Fig. 2.

Fig. 3.

Mendheim und Haupt's Gasbrennofen. (4-7)

Neuerungen an Brennofen für Thonwaaren (1-7)

Fig 6 Schnitt GH

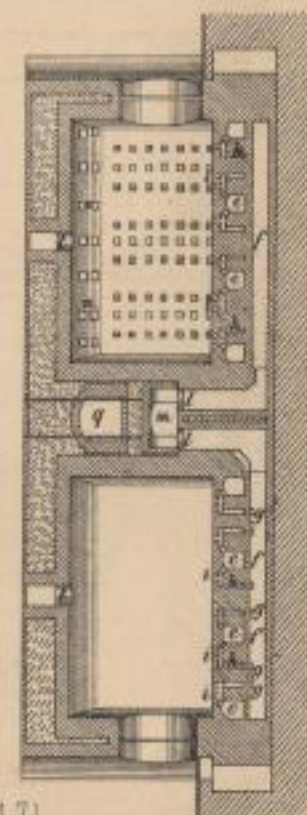

Lith. Anst. v. F. W. B. Schmidt.



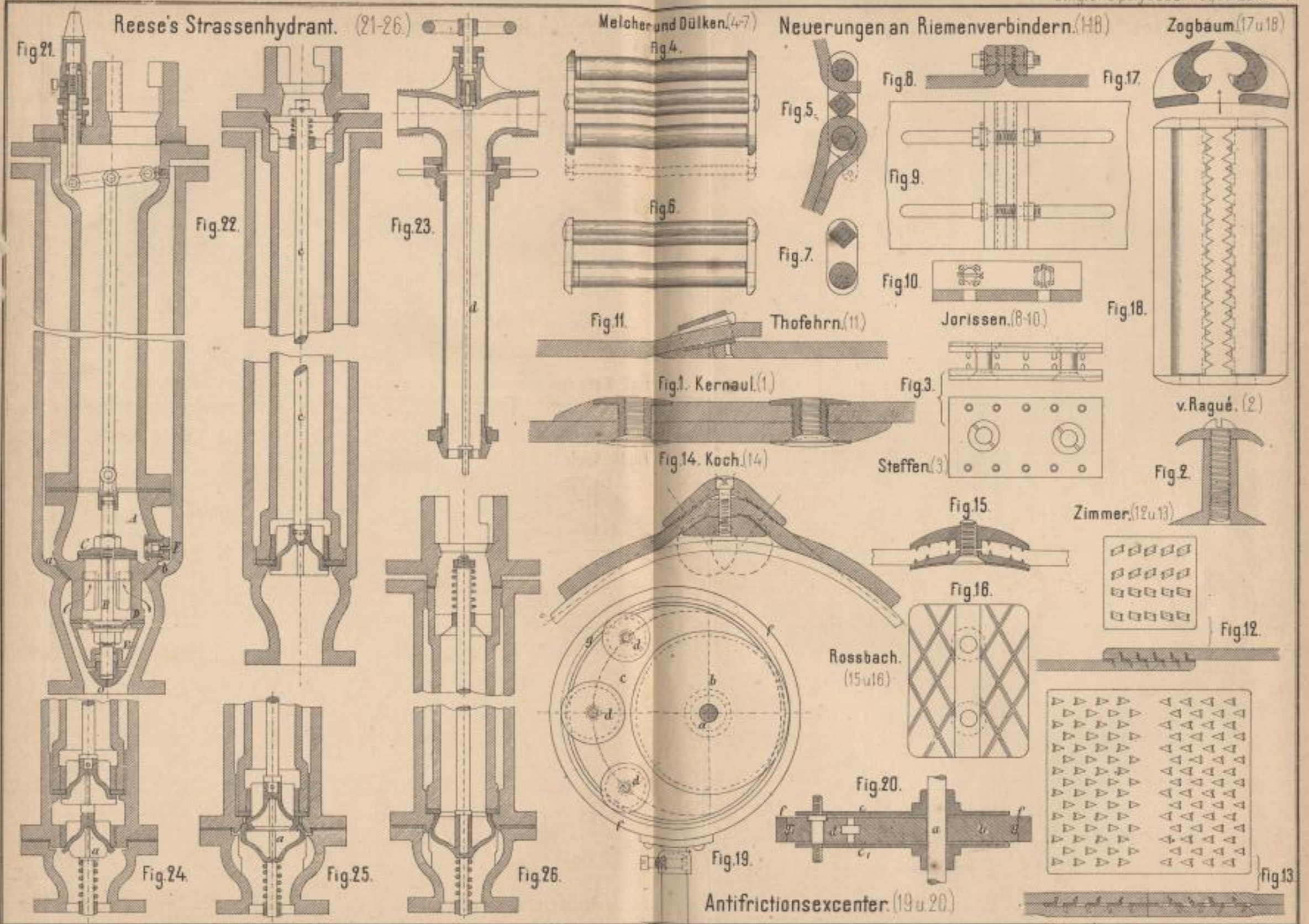

Lith. Anst. v. F. Wirtz, Darmstadt.



Käuffer's Diagramm für Wärmeüberführung. (10)

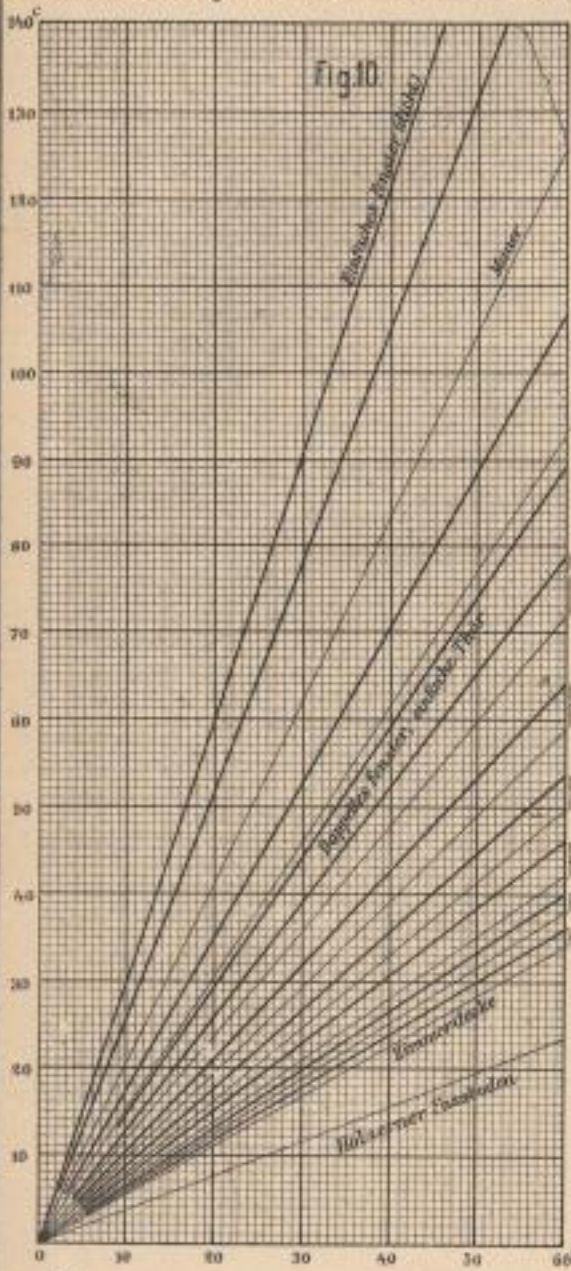

R.D. Meyer's Heizapparat für Heisswasserheizungen. (6 u 7)

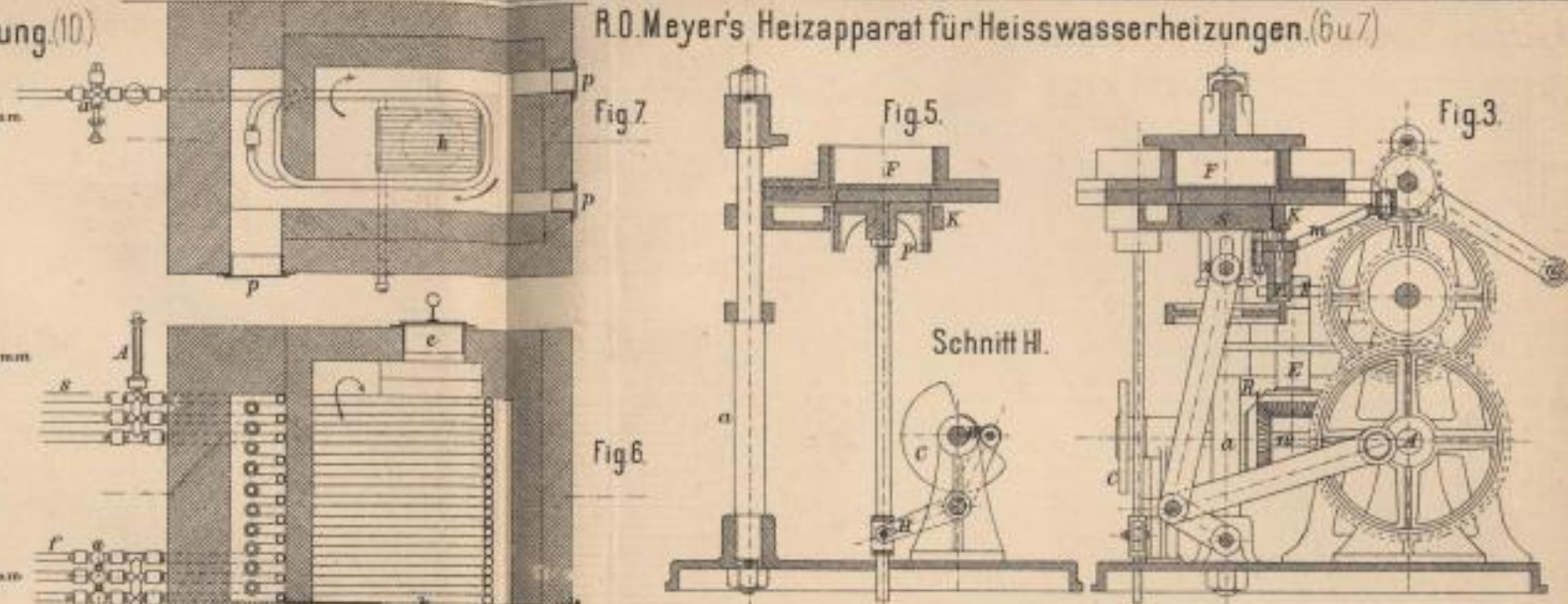

Taubrich's Ventilations-Mantelofen. (B)

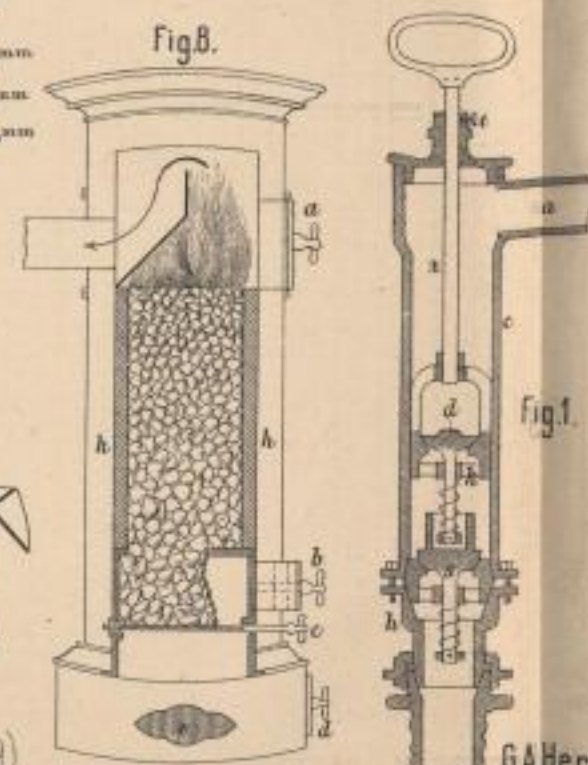

Bernhardi's Ziegelsteinpresse. (3-5)

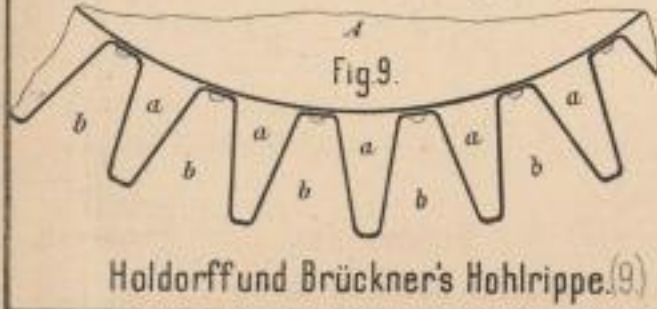
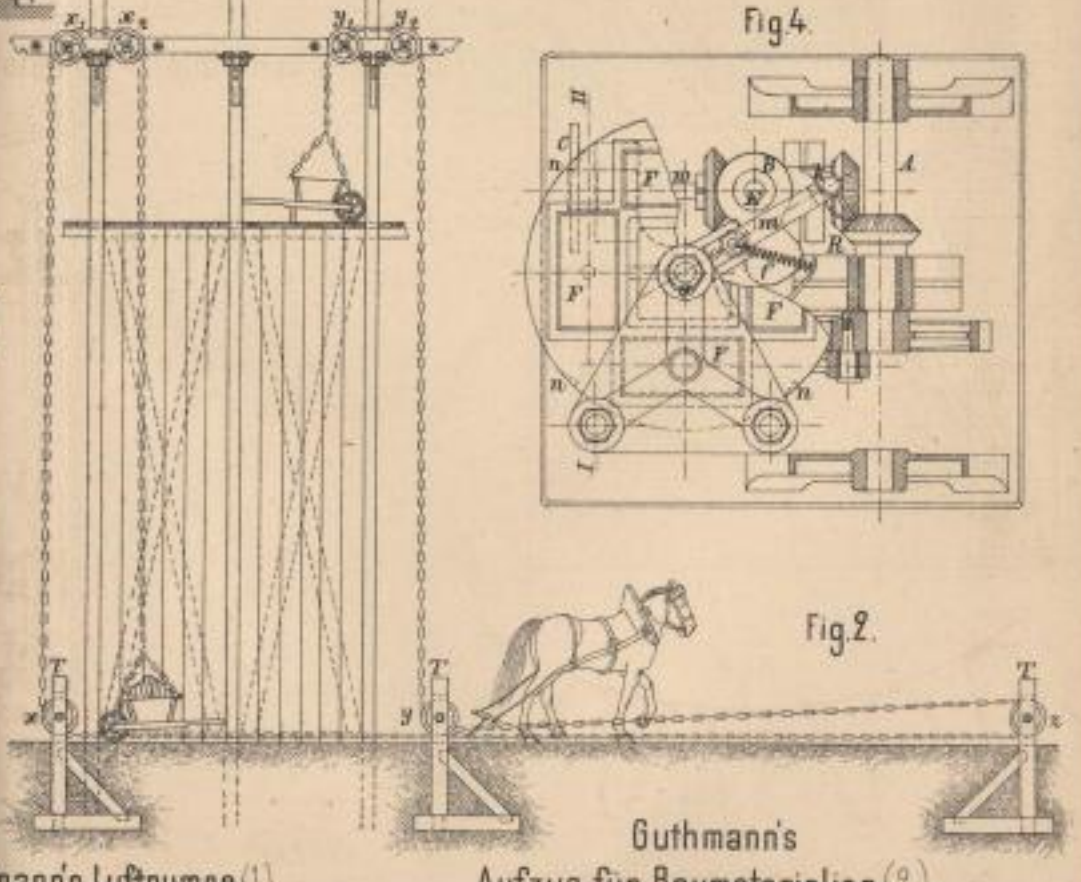

Lith. Anst. v. F.W. Neumann, Darmstadt.



Quitmann's Quadrillmaschine. (8-12)

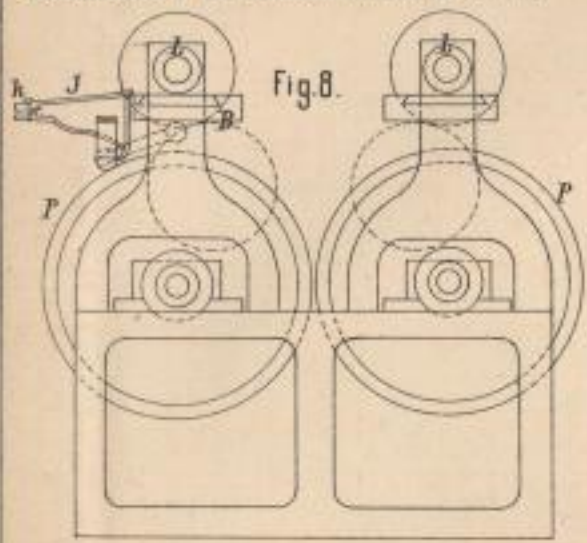

Fig. 8.

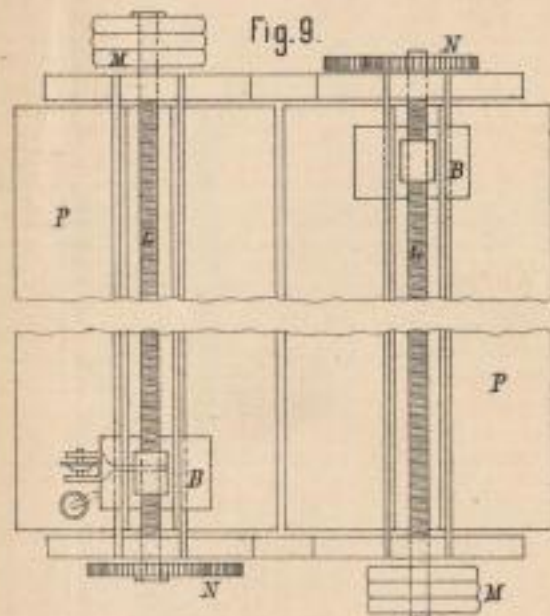

Fig. 9.

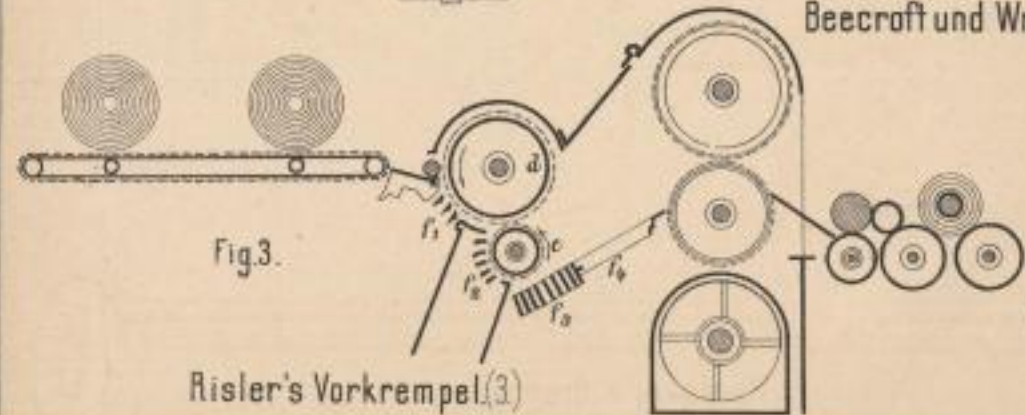

Fig. 3.

Risler's Vorkrempel. (3)

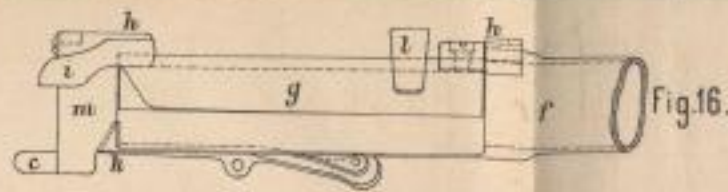

Fig. 16.

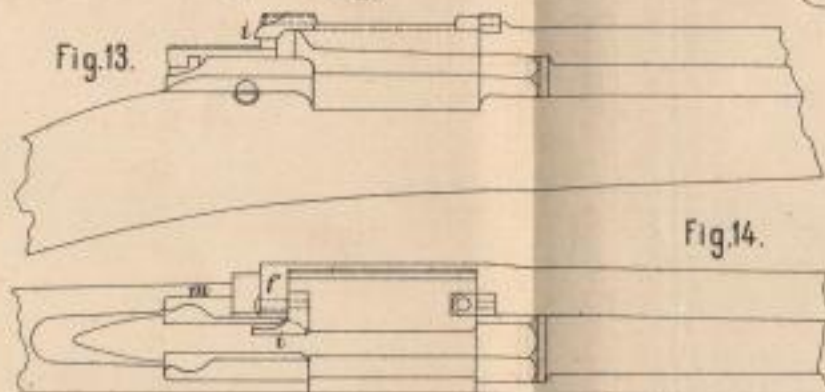

Fig. 13.

Fig. 14.

Werndl's Repetirgewehr. (13-16)

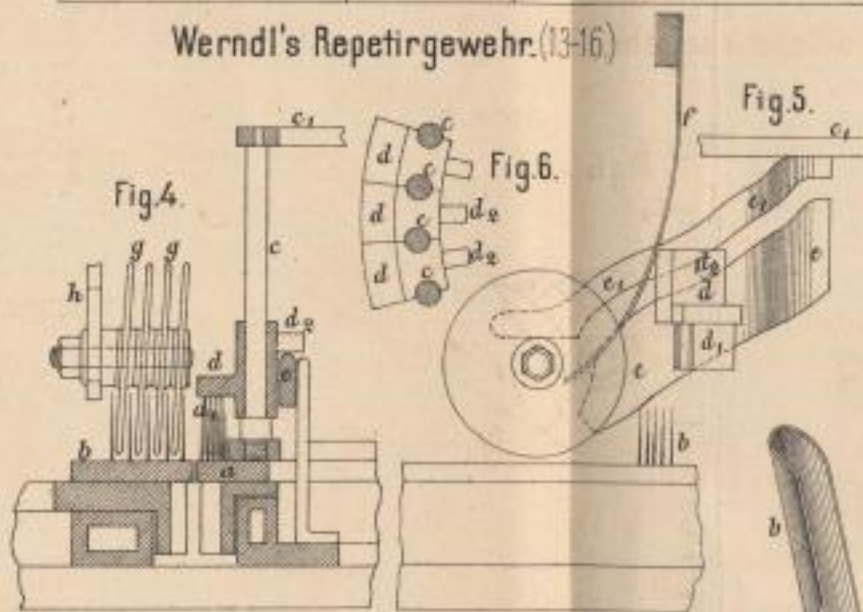

Fig. 4.

Fig. 6.

Fig. 5.

Neuerburg's Austrageregulator. (1u. 2)

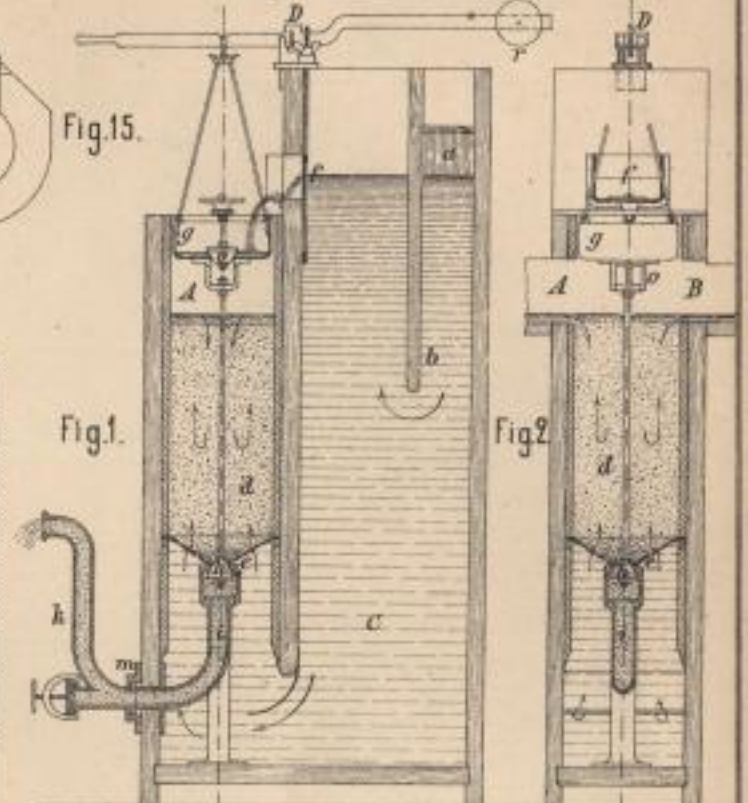

Fig. 1.

Fig. 2.

Tronchon's Kerze. (17)

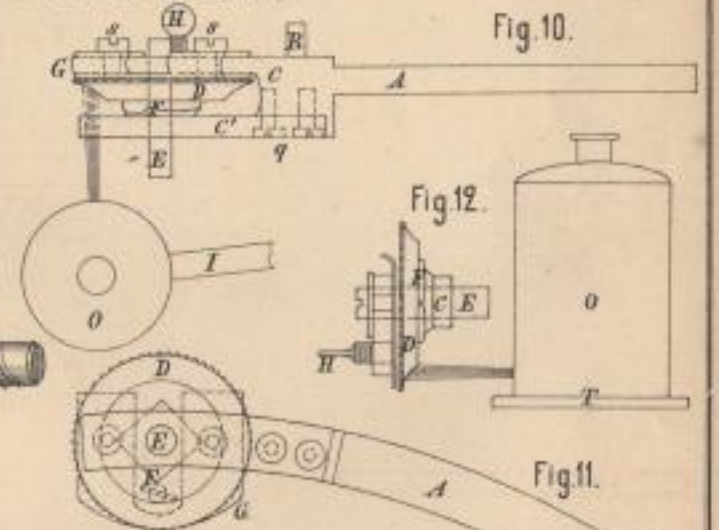

Fig. 10.

Fig. 12.

Beecroft und Wright's Kammmaschine. (4-6)

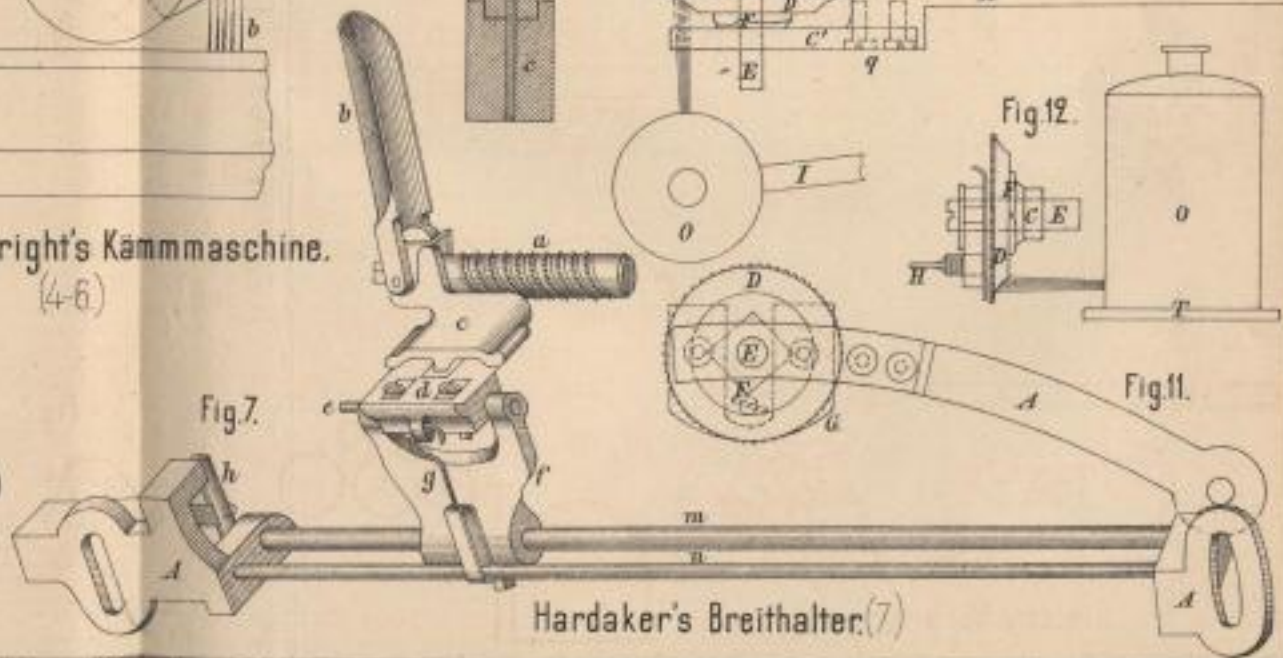

Fig. 7.

Hardaker's Breithalter. (7)

Lith. Anst. v. F. W. v. Dornstadt.



### Bramão's Schreibtelegraph. (4-8)

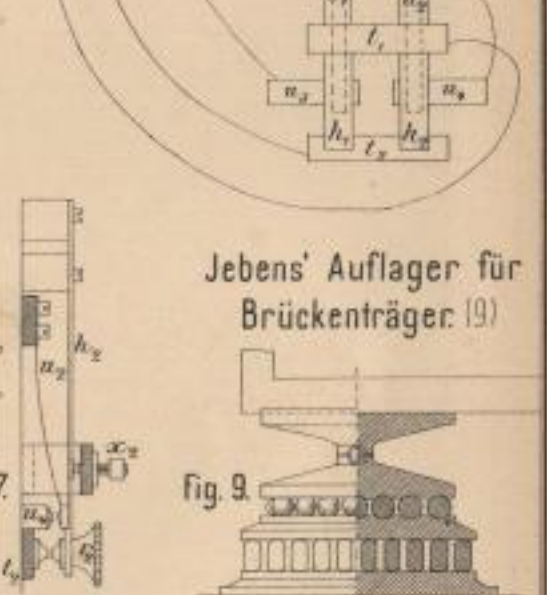
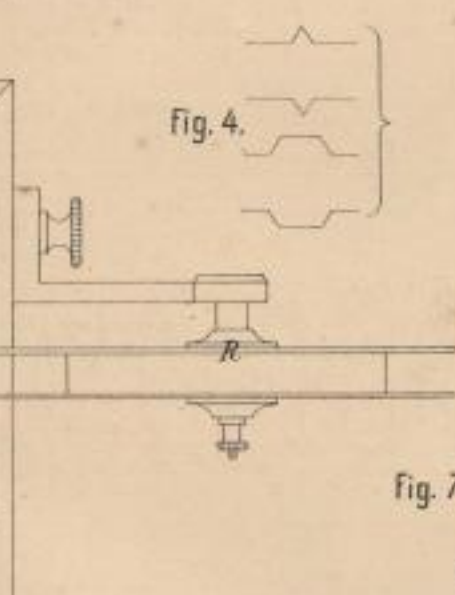
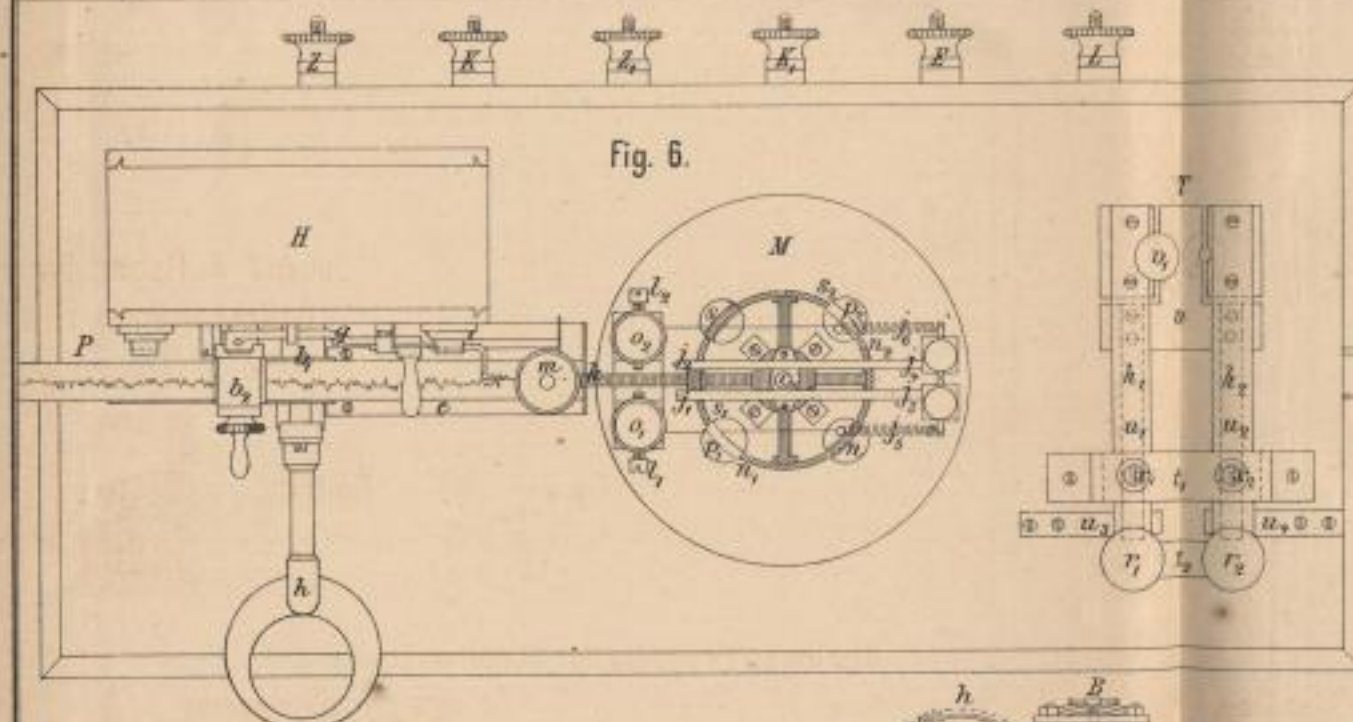
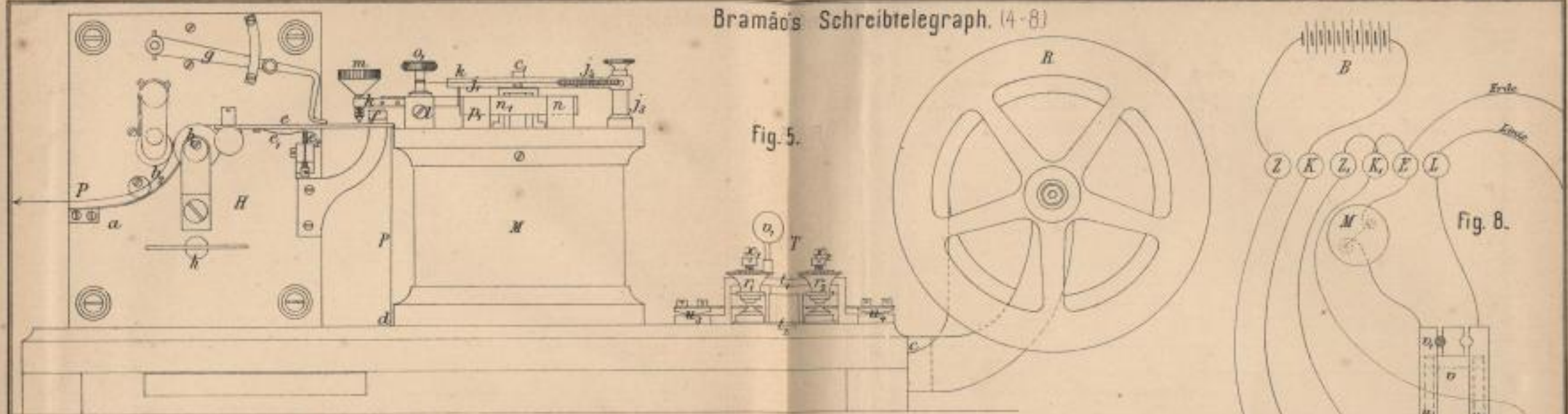

### Giering's Pressmuster-Copiermaschine. (1-3)

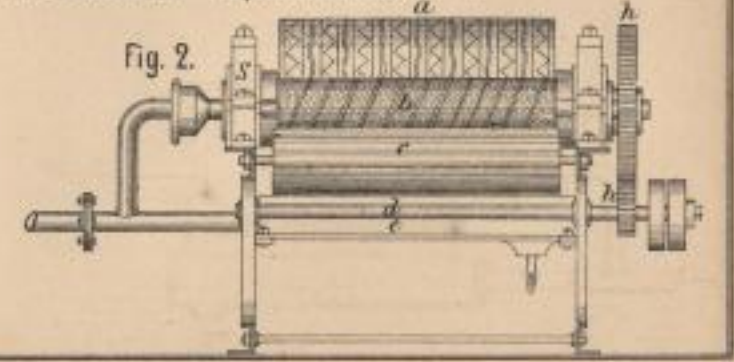
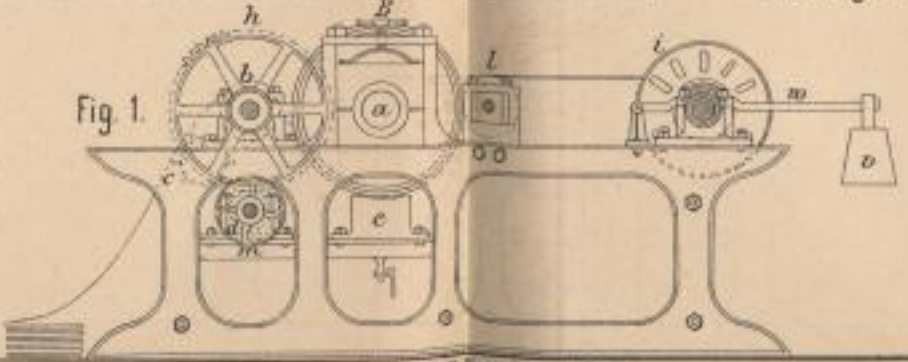
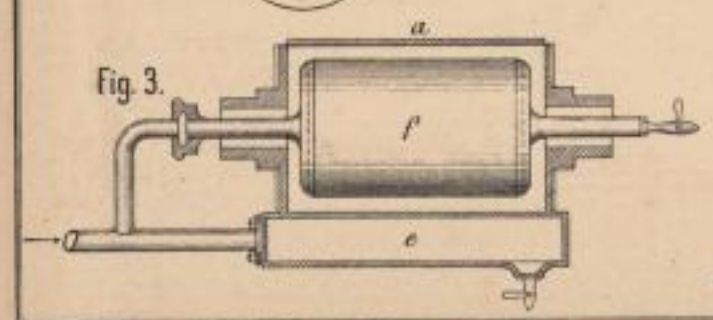

*Lith. Anst. v. F. W. Barth, Darmstadt.*



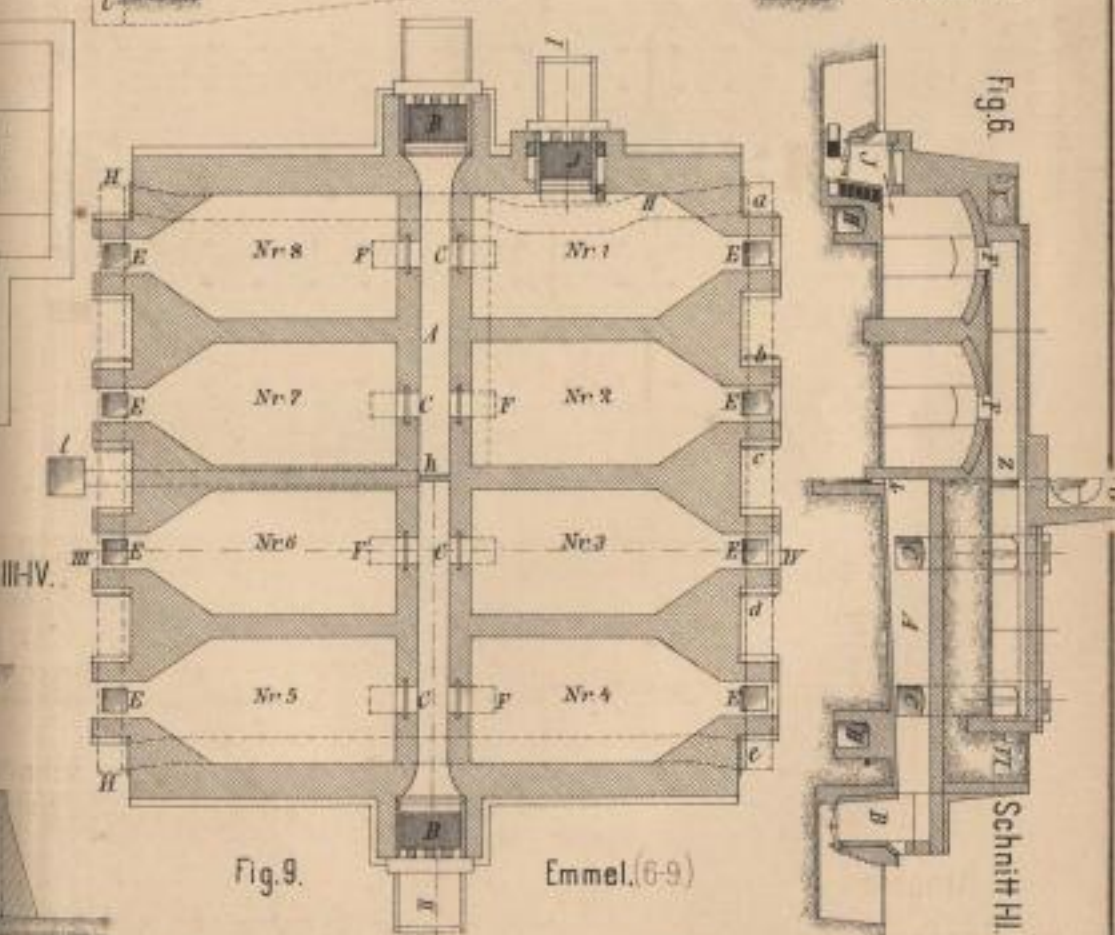
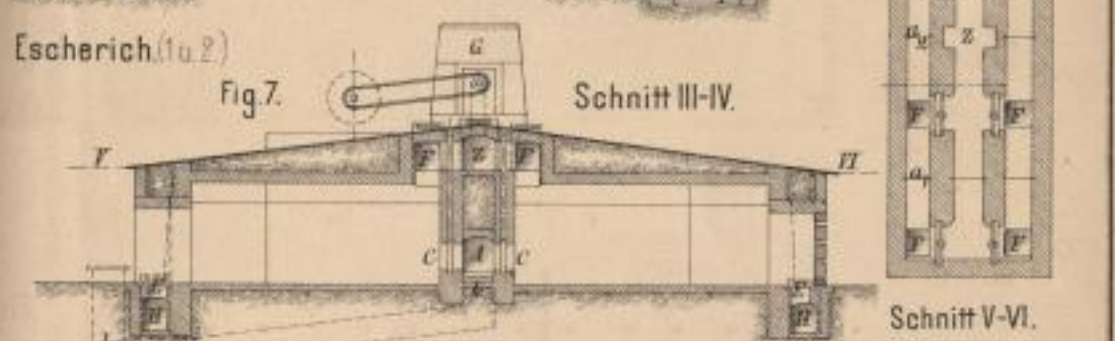
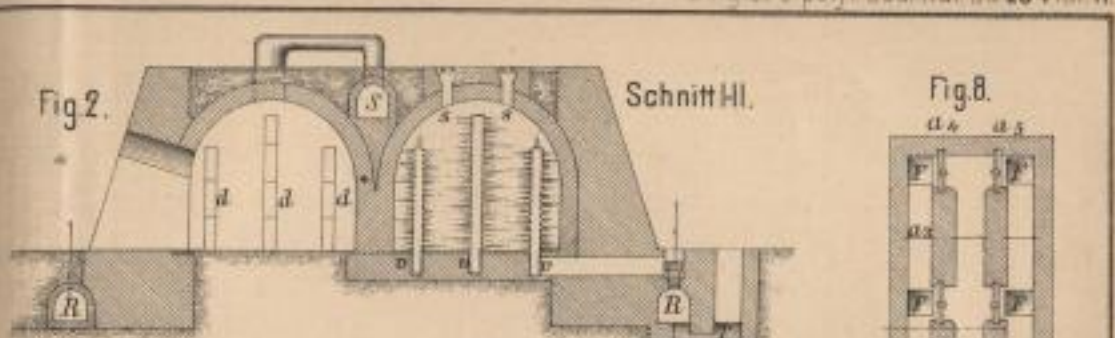
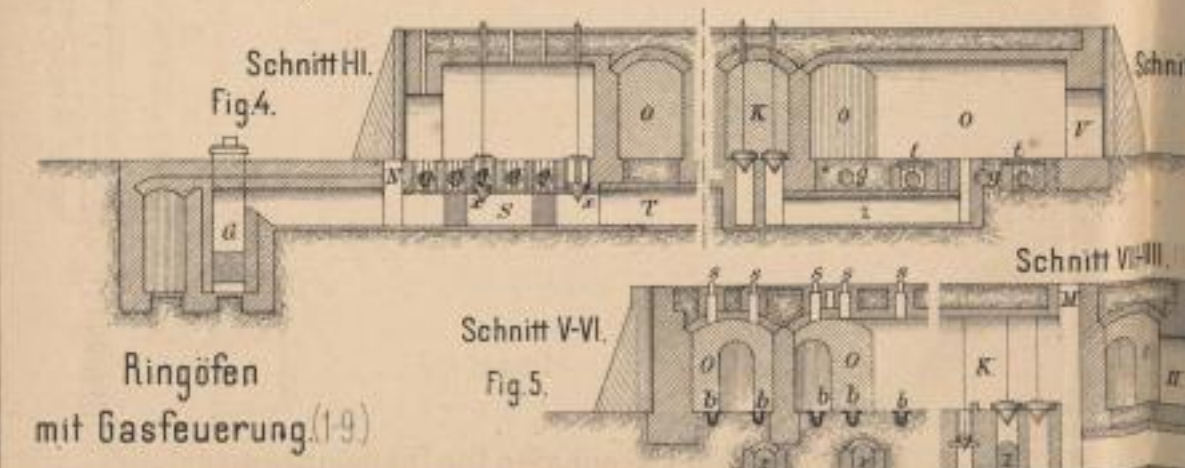
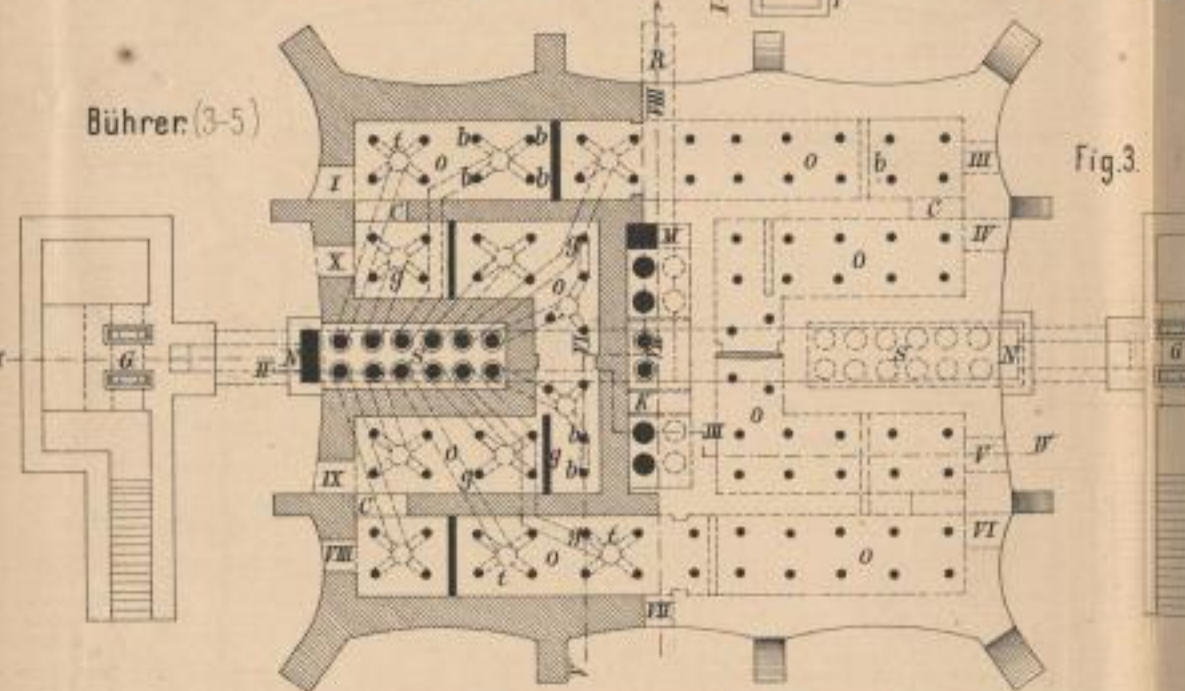
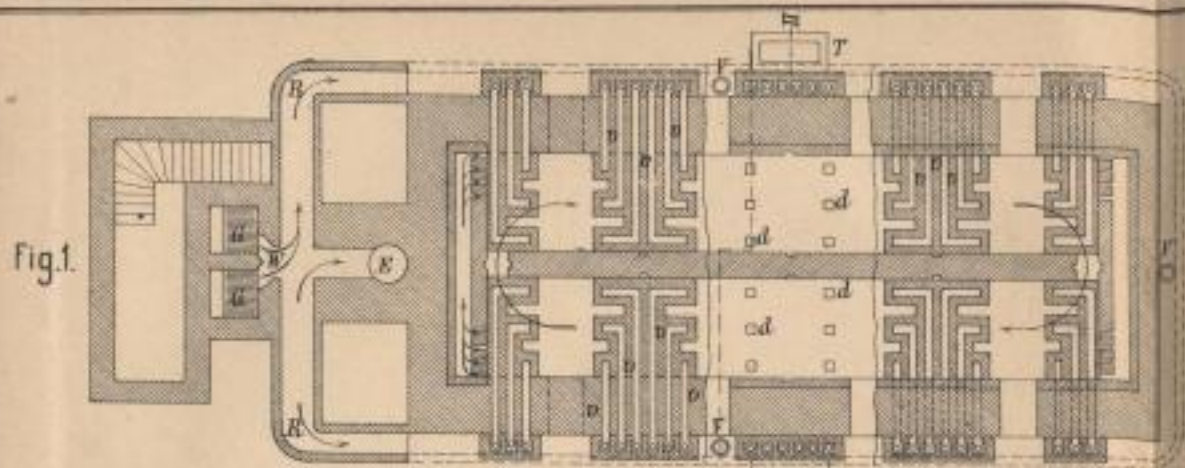

Neuerungen an Brennöfen für Thonwaaren u.dgl. (19)

lith. Anst. v. W. Darmstadt



Pampe's Maischapparat. (4-8)

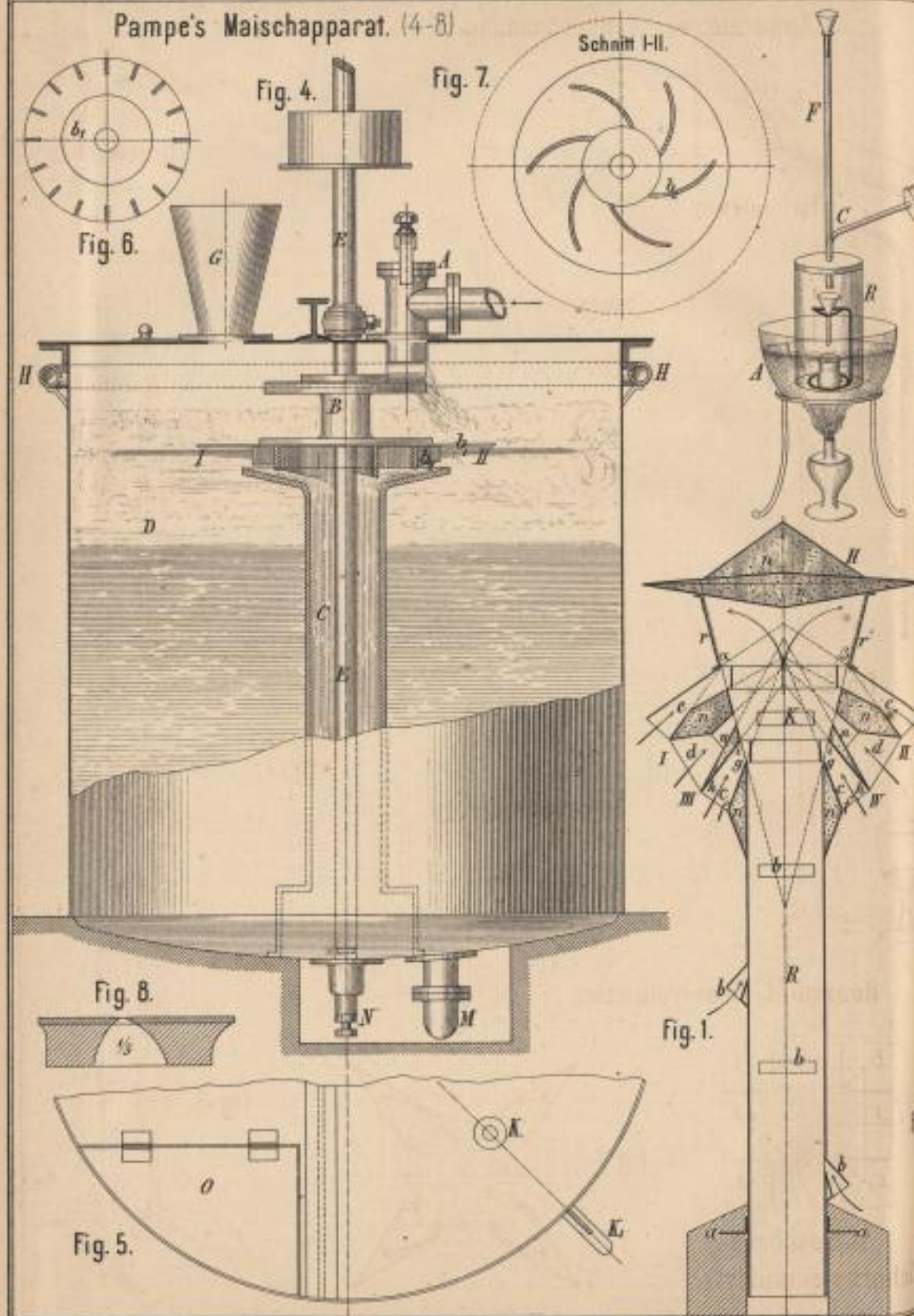

Apparate zur Fettbestimmung. (10-13)

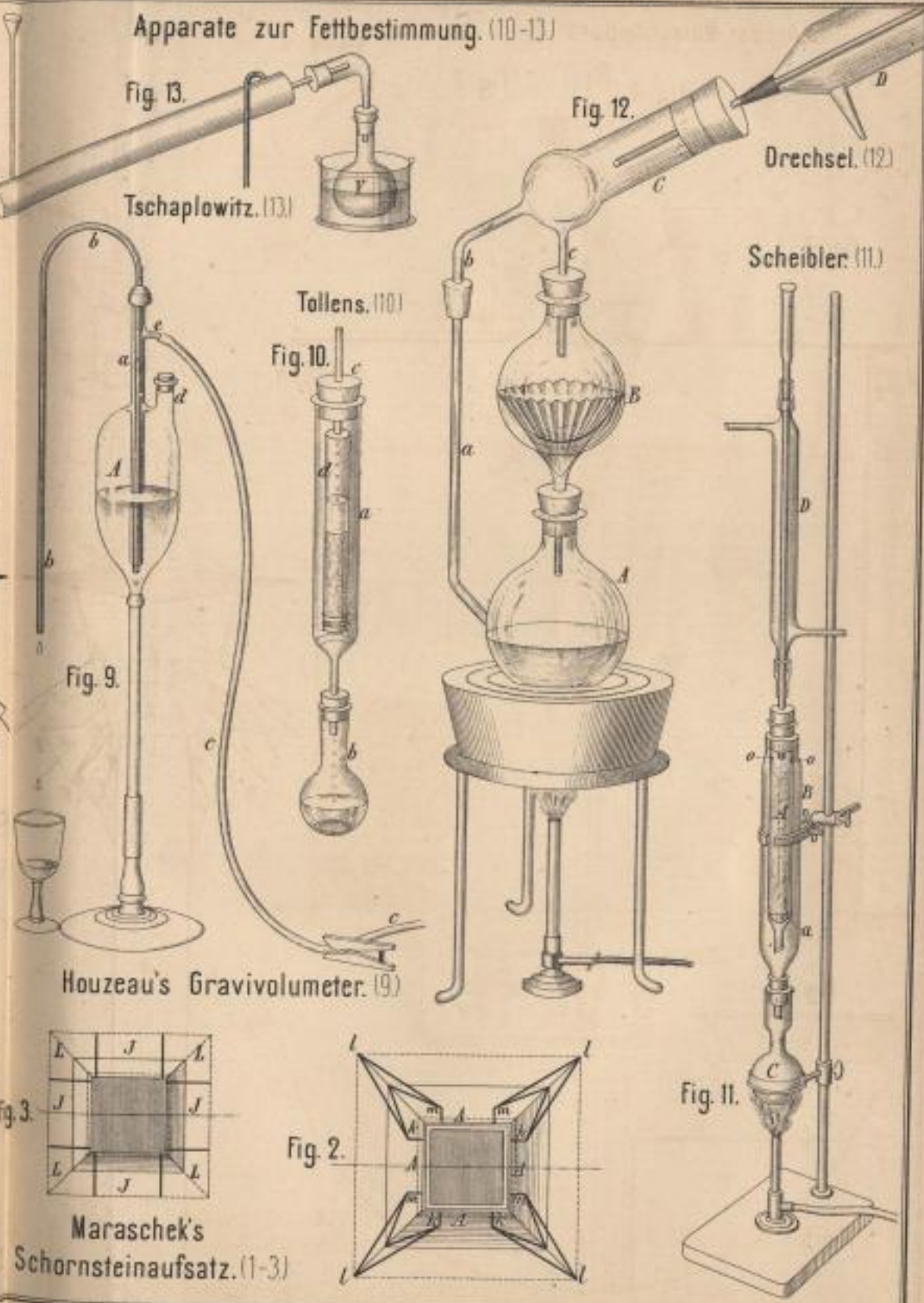

Leib. Anst. P. Wirtz, Darmstadt.



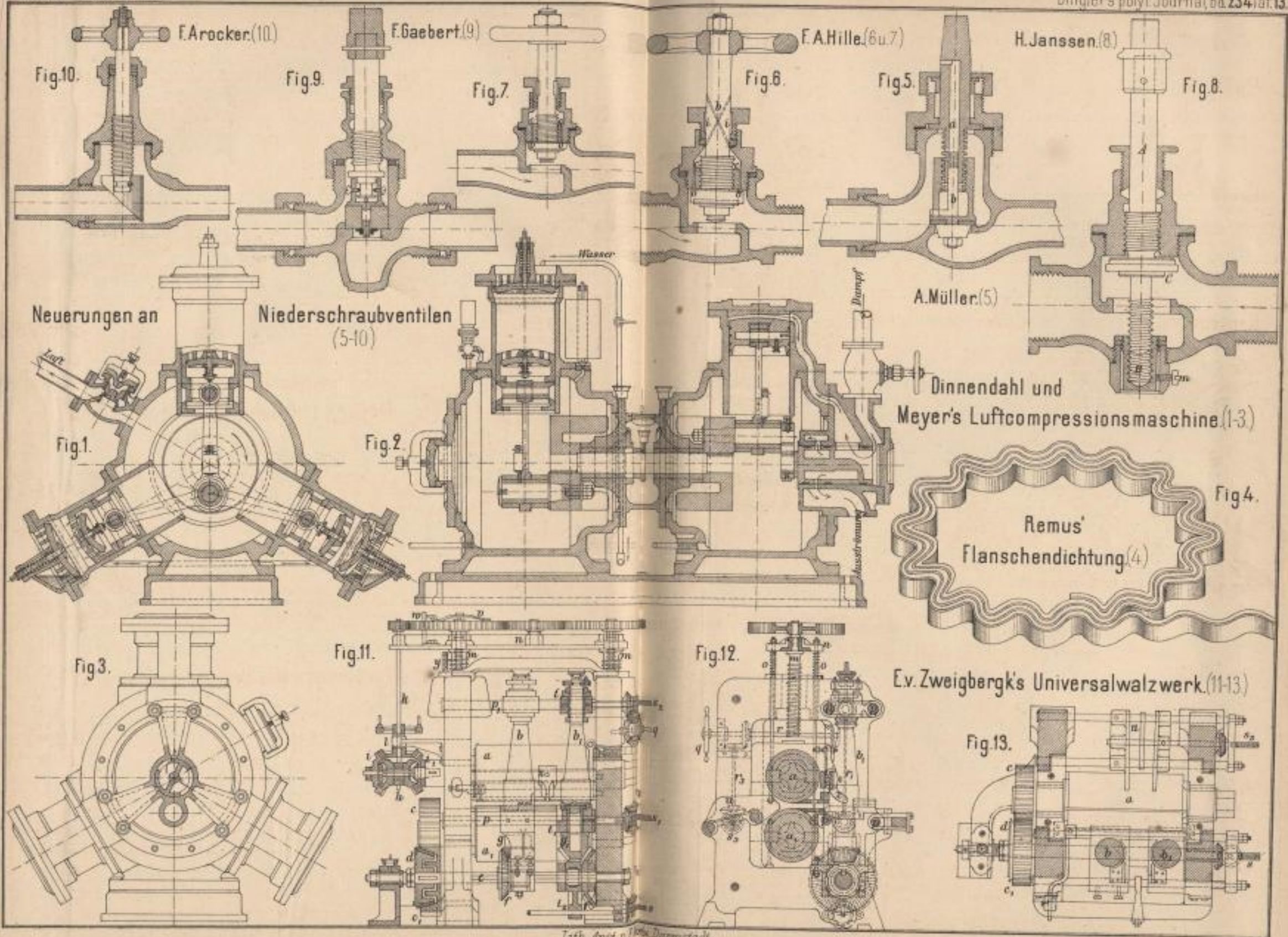

Lith. Anst. v. 1864 Darmstadt.



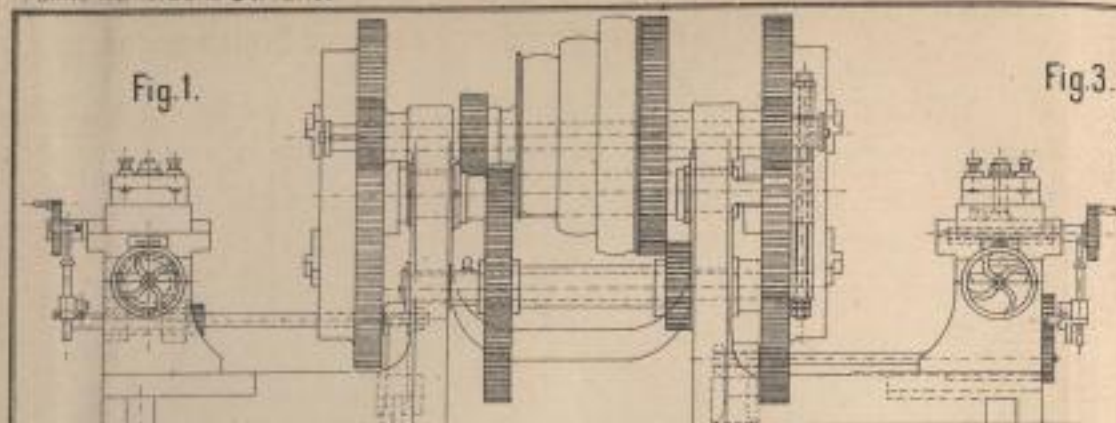

Fig. 1.

Fig. 3.

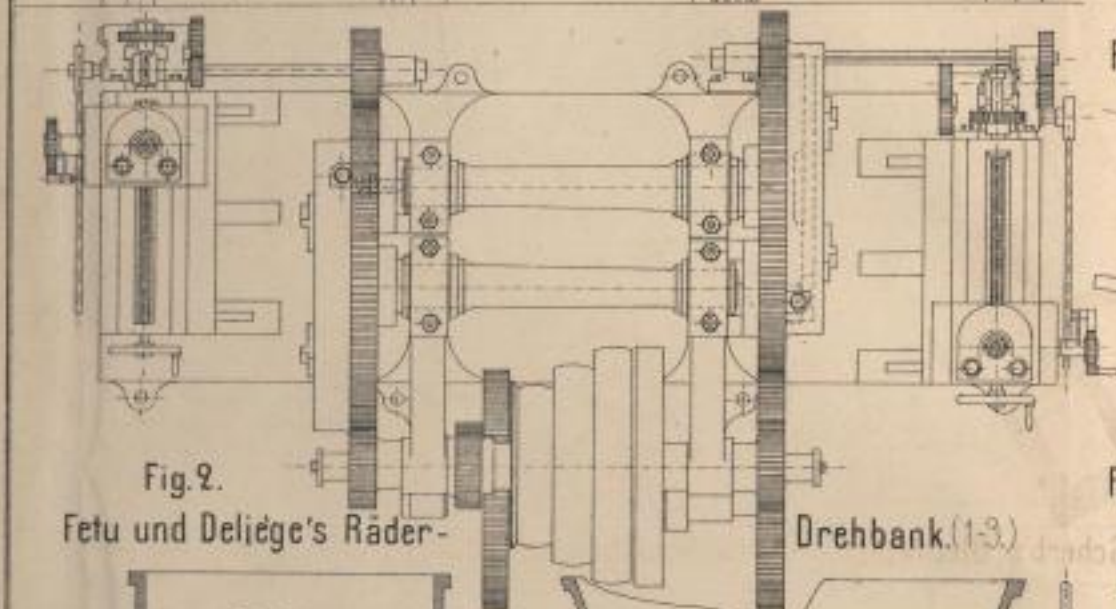
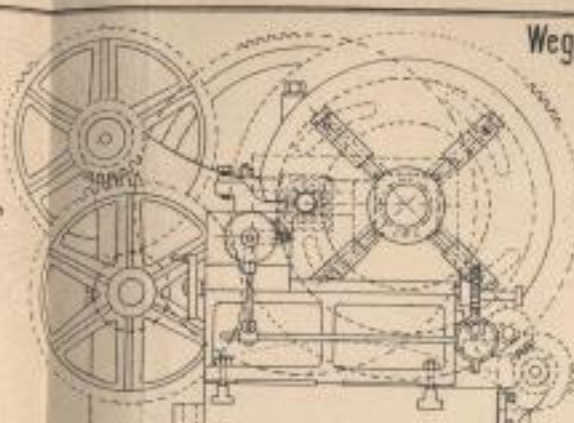

Fig. 2. Fetu und Deliége's Räder-Drehbank.

Drehbank. (13.)

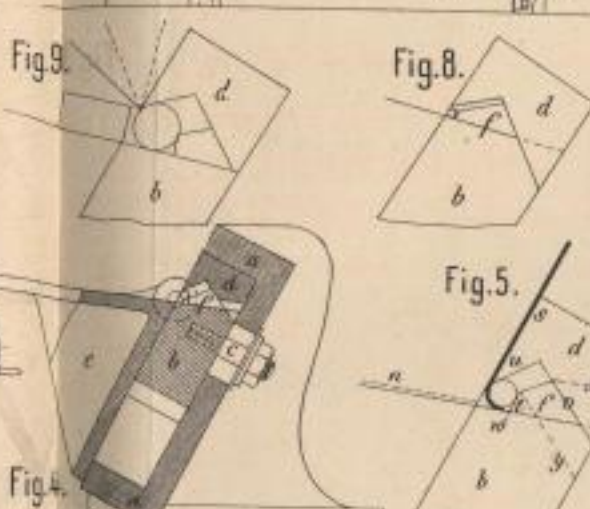

Fig. 4.



Fig. 5.



Fig. 6.



Fig. 7.



Fig. 8.

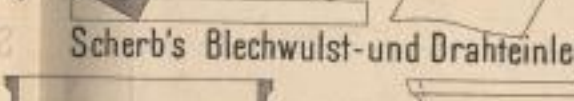

Fig. 9.

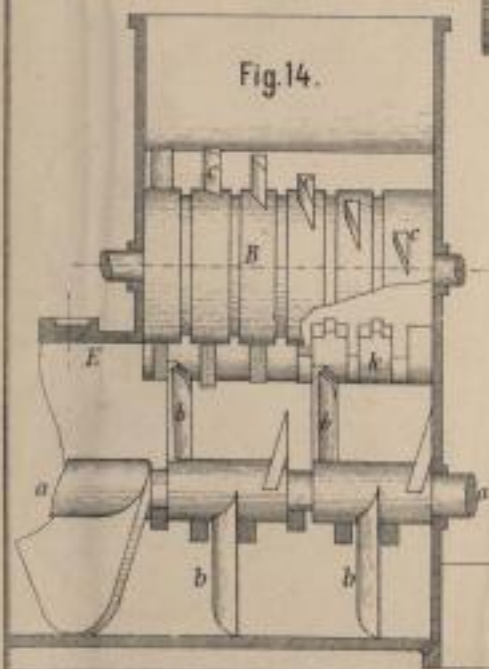

Fig. 14.

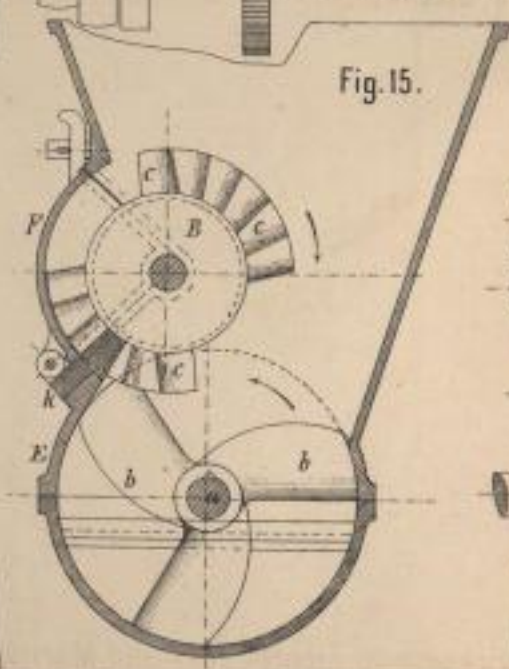

Fig. 15.

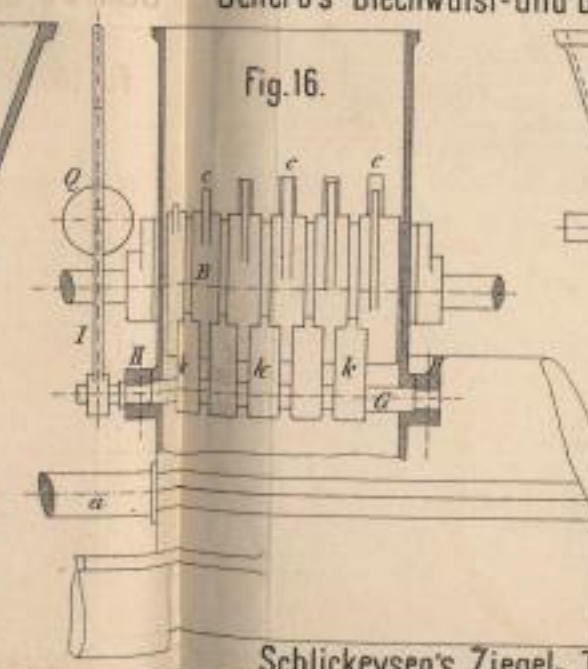

Fig. 16.

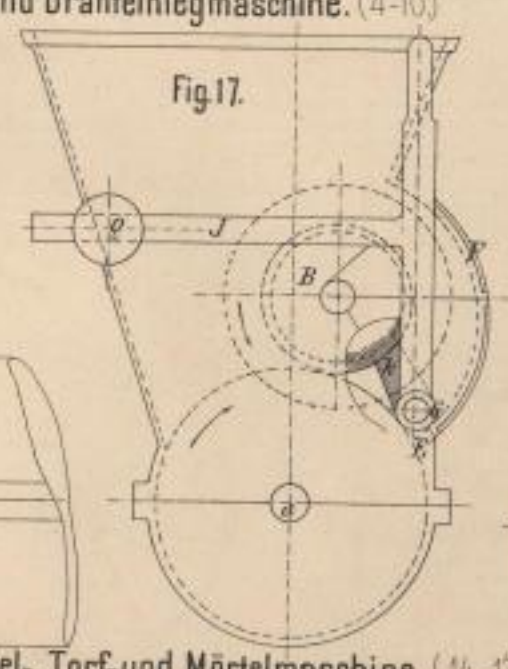

Fig. 17.

Wegge und Pelzer's Kern- und Schlangenbohrer.

(11-13.)

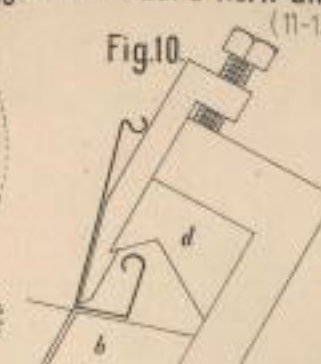

Fig. 10.

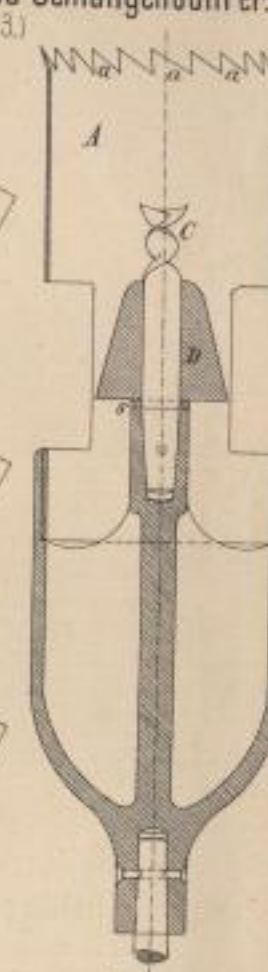

Fig. 11.

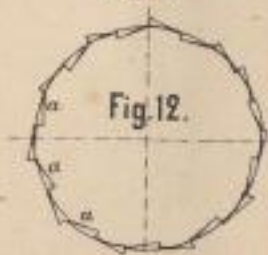

Fig. 12.



Fig. 13.

Scherb's Blechwulst- und Drahteinlegmaschine. (4-10.)

Schlickeysen's Ziegel-, Torf- und Mörtelmaschine. (14-17.)

Leh. Anstalt von C. F. W. Dornow



O.L. Klein's Speiseapparat sowie Josephy's und Bolette's Vliesstheiler für Wollkarden. (1-4)

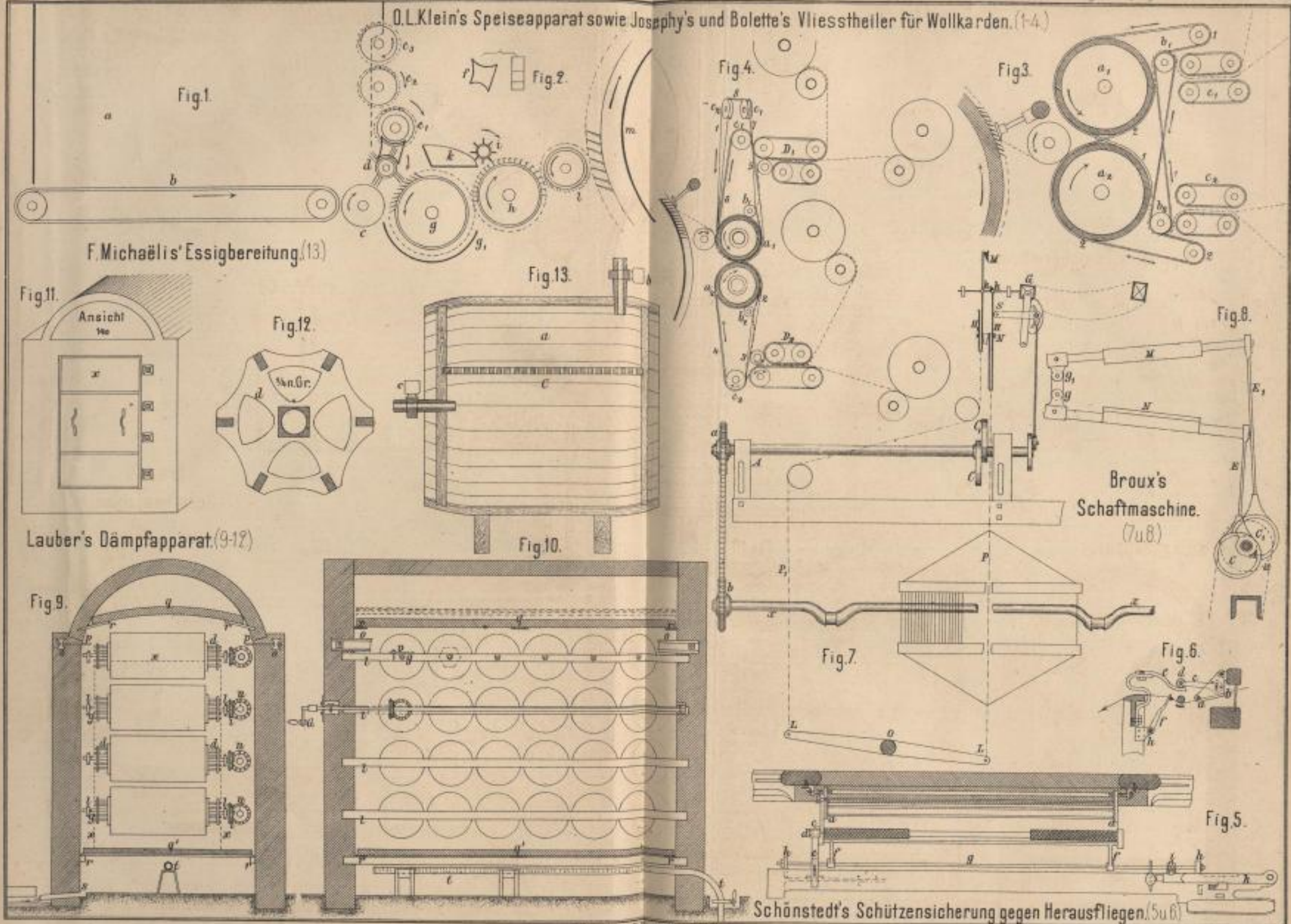

Lith. Anst. v. F. Preis Darmstadt.



D. Adamson: Ueber Eigenschaften von Eisen und weichem Stahl. (Taf. 16 u. 17)

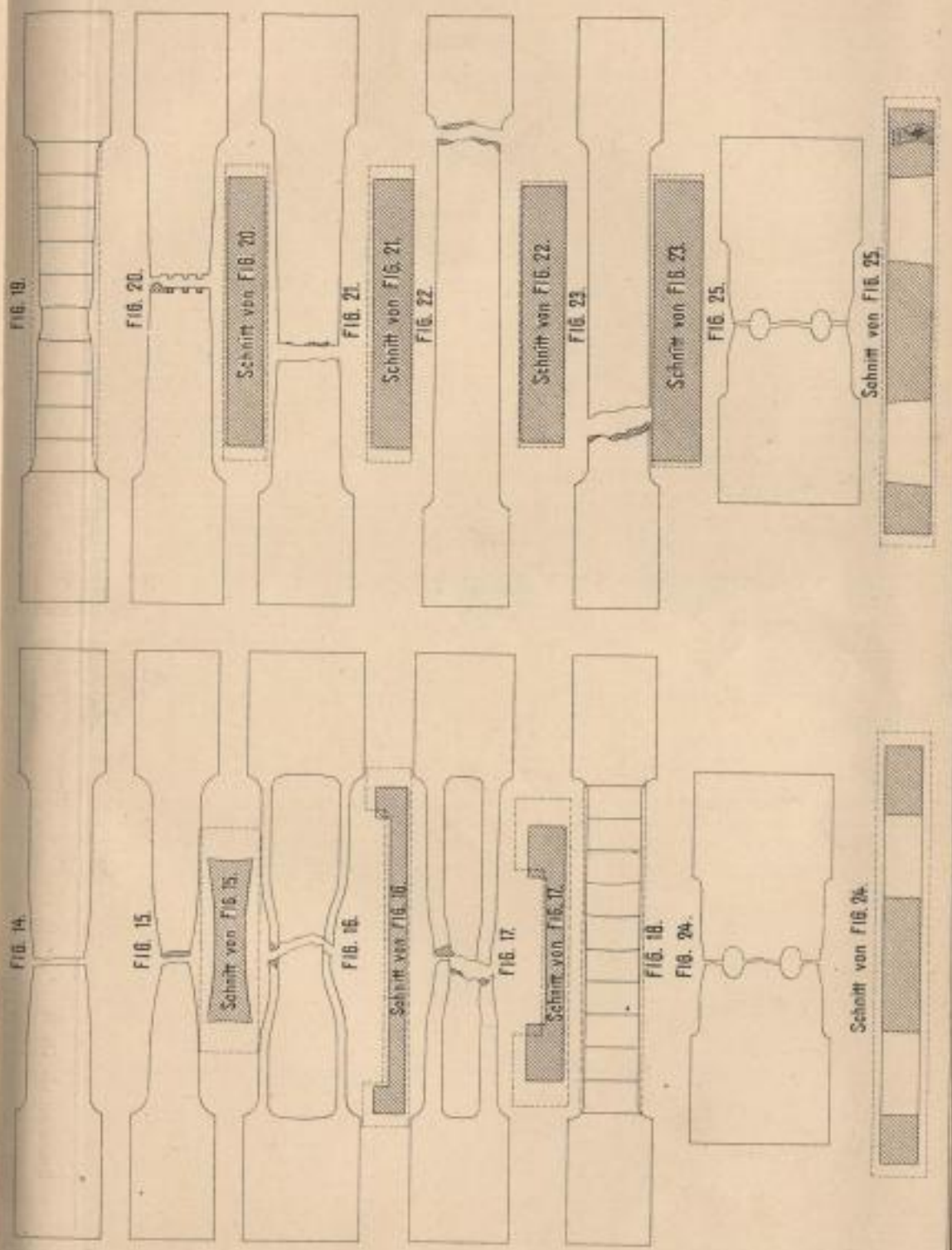
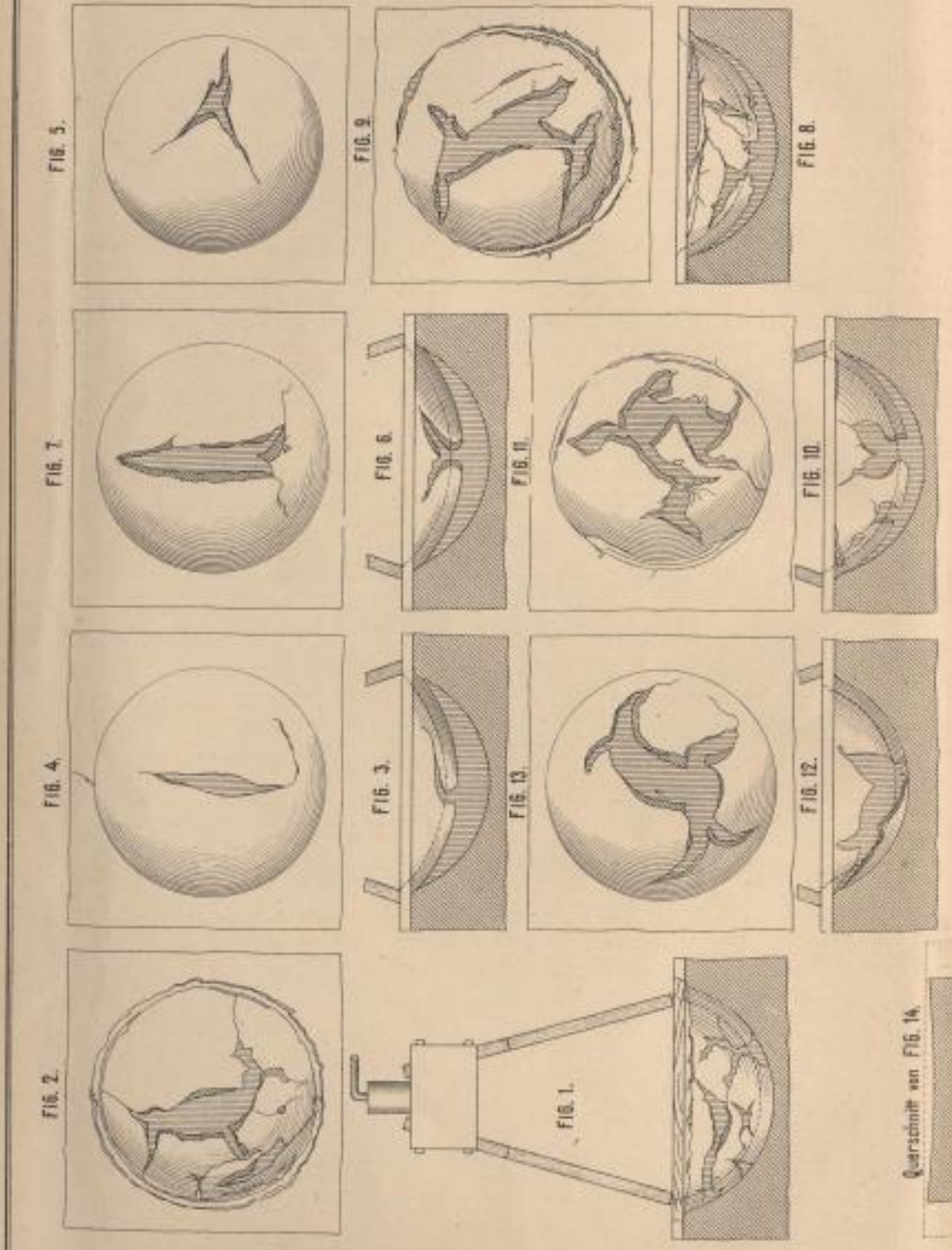

Exp. Anst. v. F. Reib. Darmstadt



D. Adamson: Ueber Eigenschaften von Eisen und weichem Stahl. (Taf. 16 u. 17)

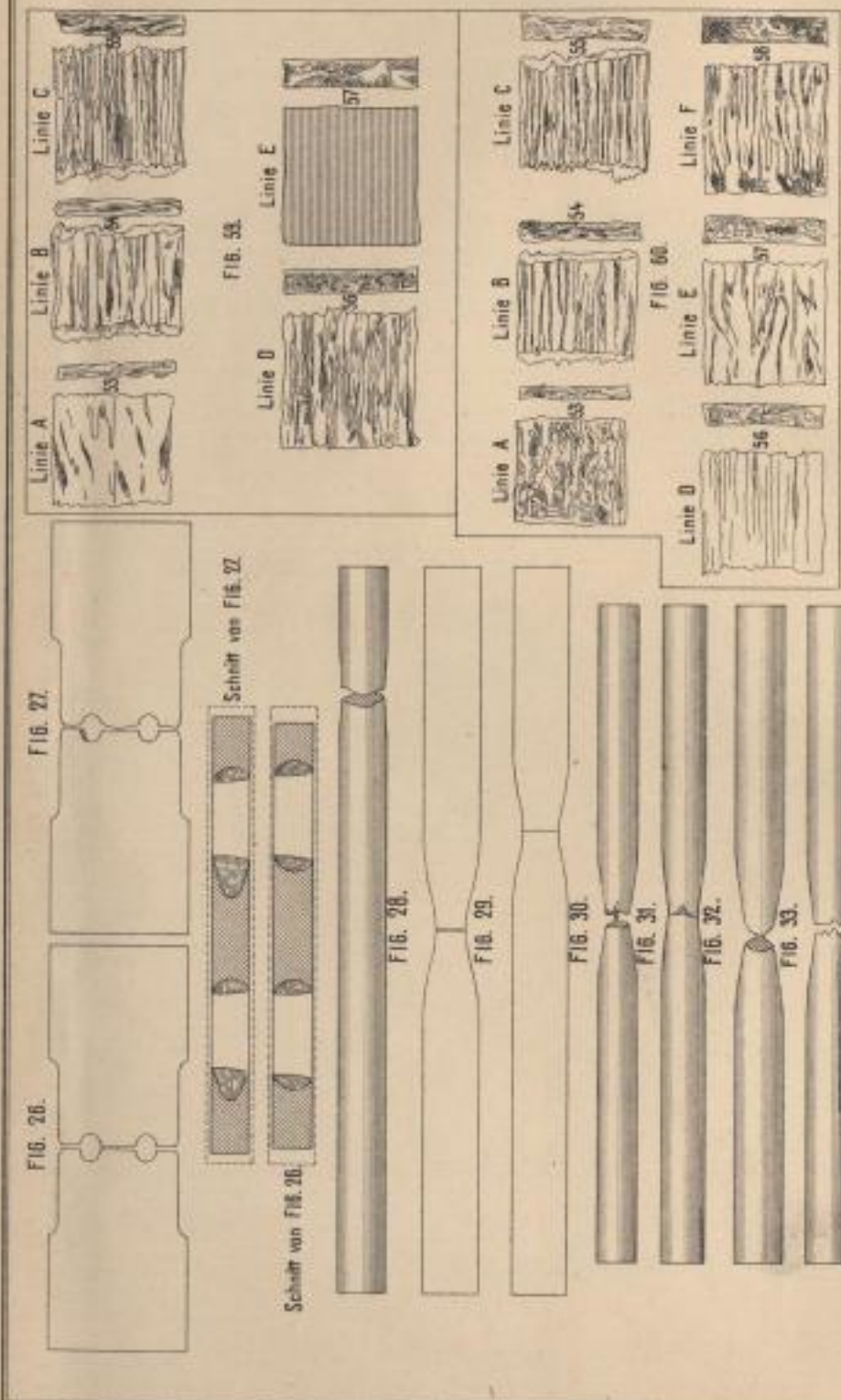

Lith. Anst. v. J. Neumann, Neudamm.



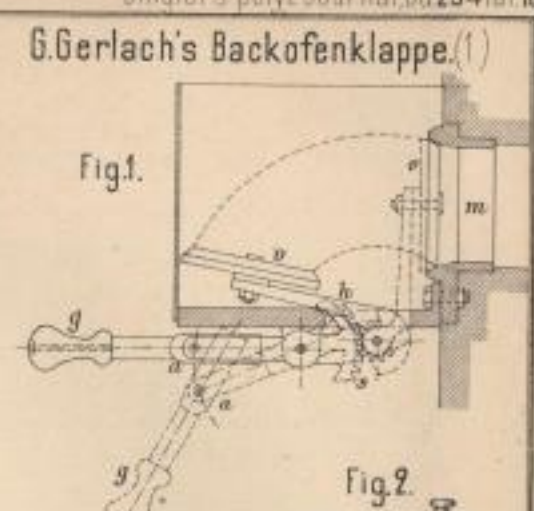
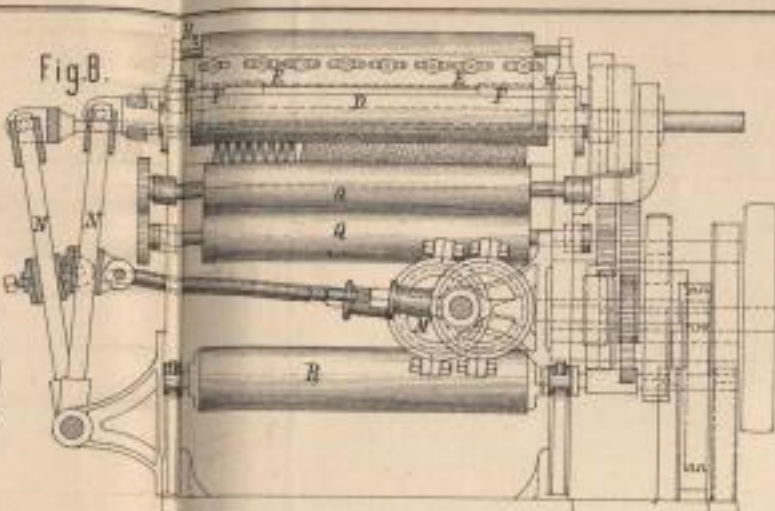
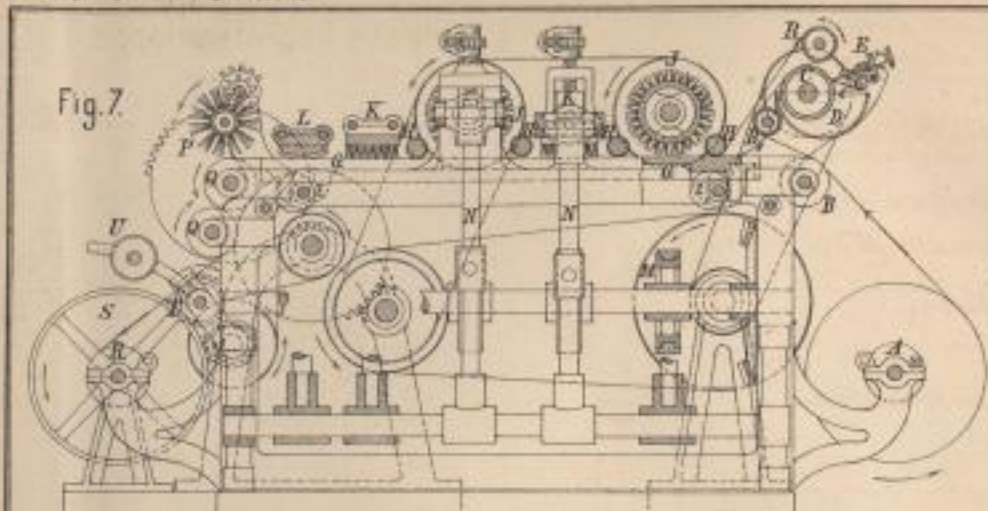

G. Gerlach's Backofenklappe (1)

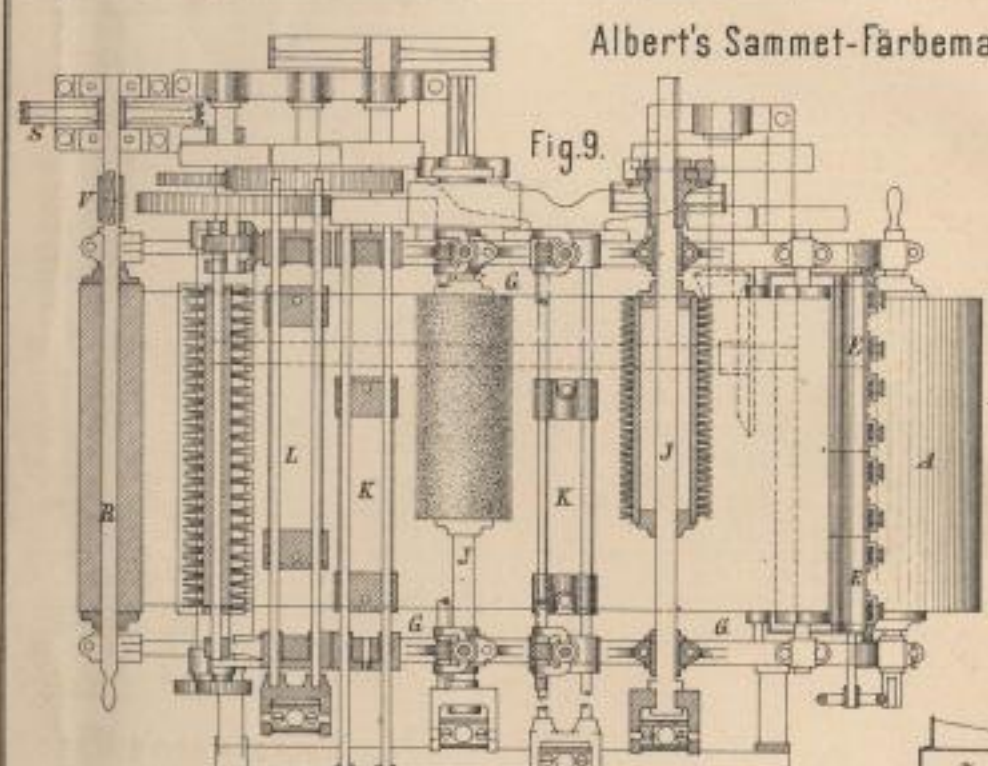

Albert's Sammet-Färbemaschine (7-9)

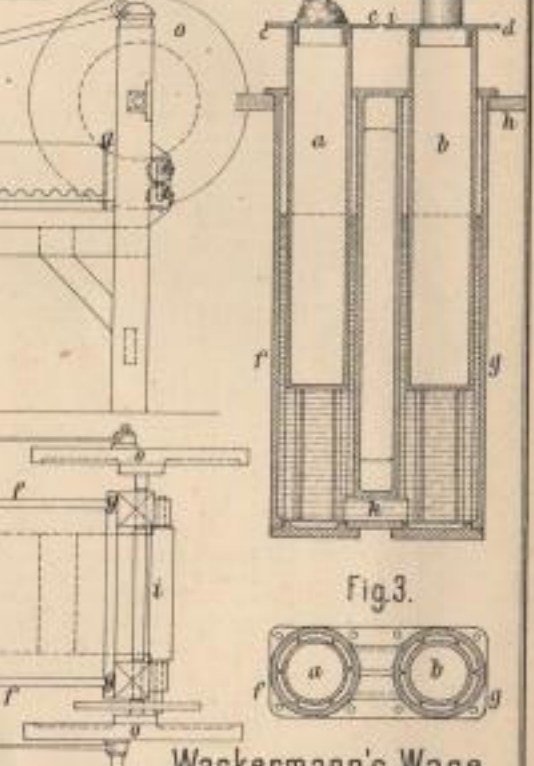
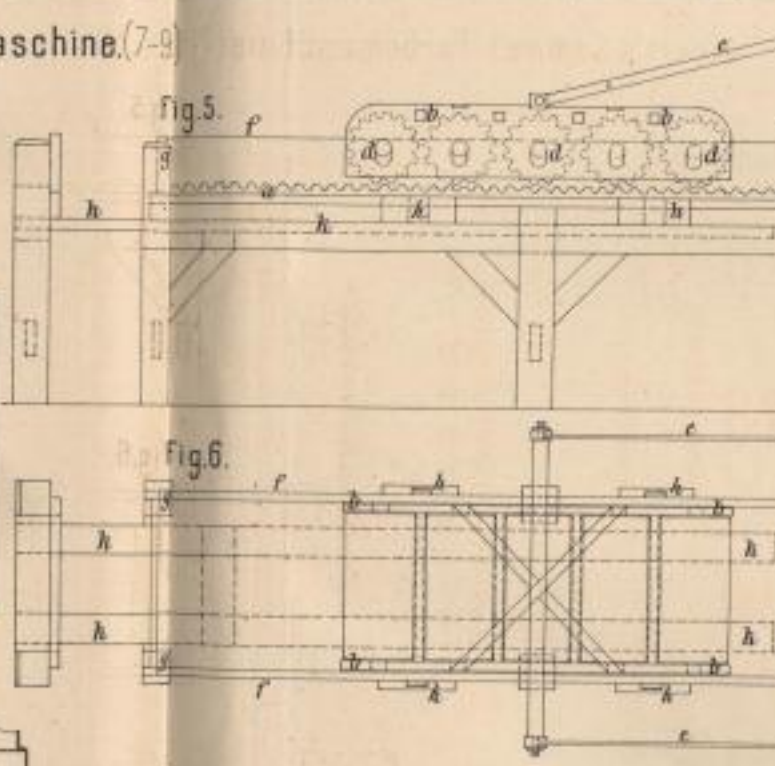
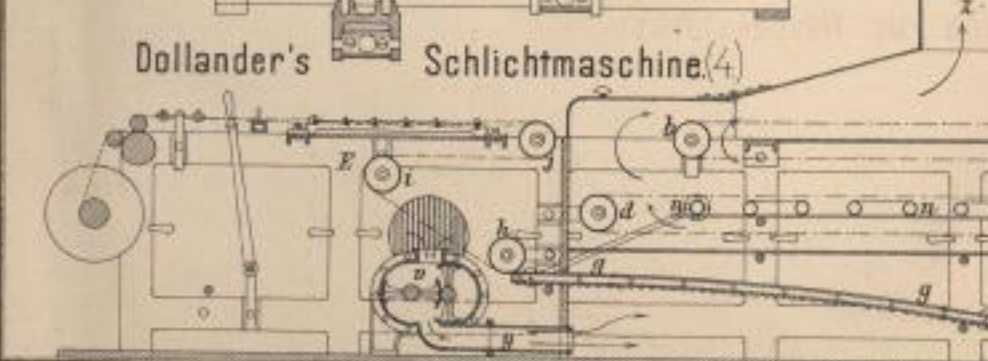

Fig. 2



Dollander's Schlichtmaschine (4)



Raabe's Maschine zum Wäschestärken (5 u 6)



Wackermann's Wage (2 u 3)

Fig. 4

lith. Anst. v. E. W. Dornstadt.



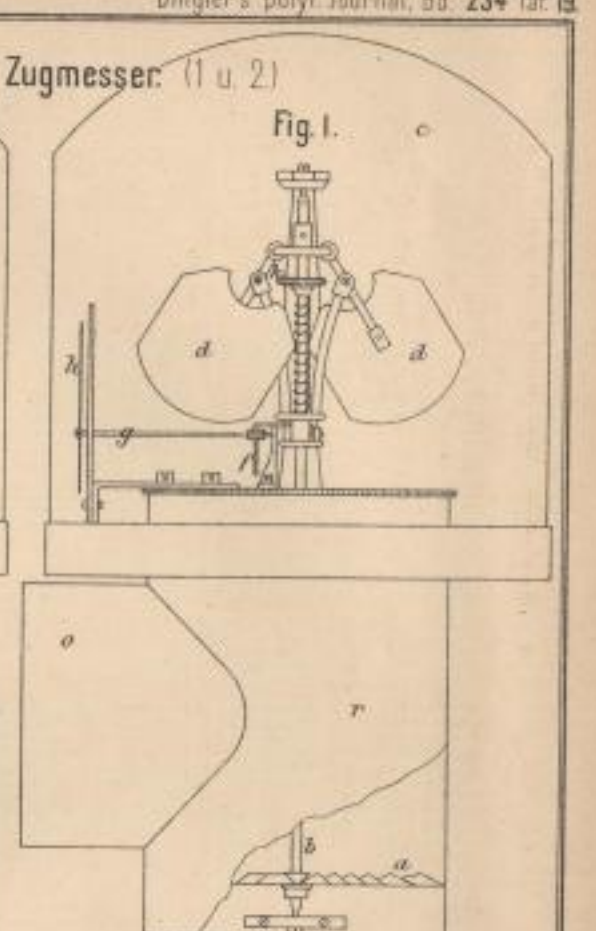
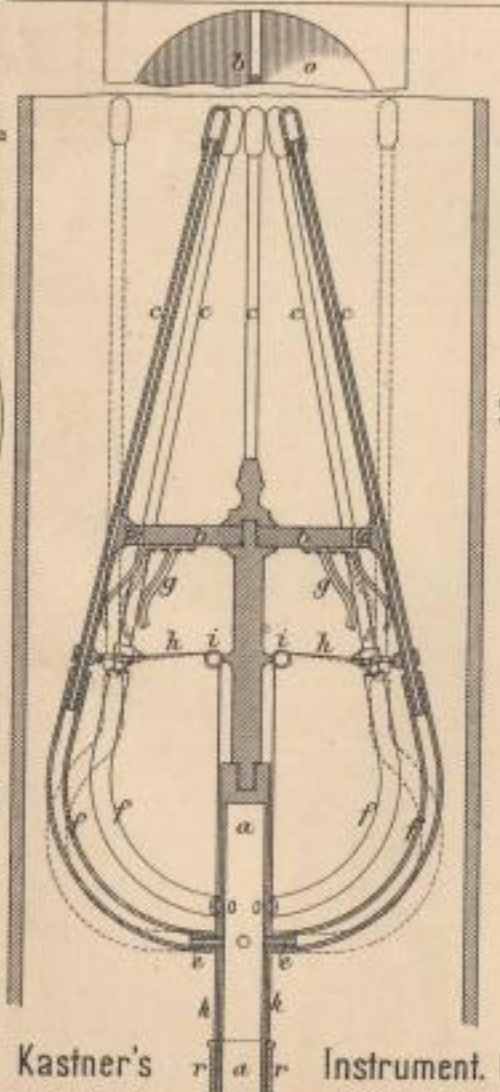
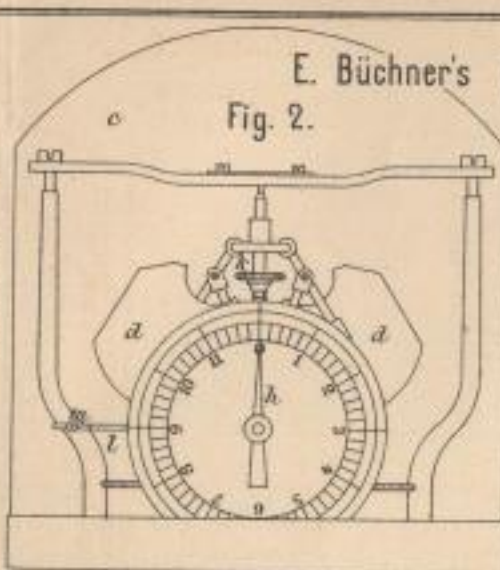
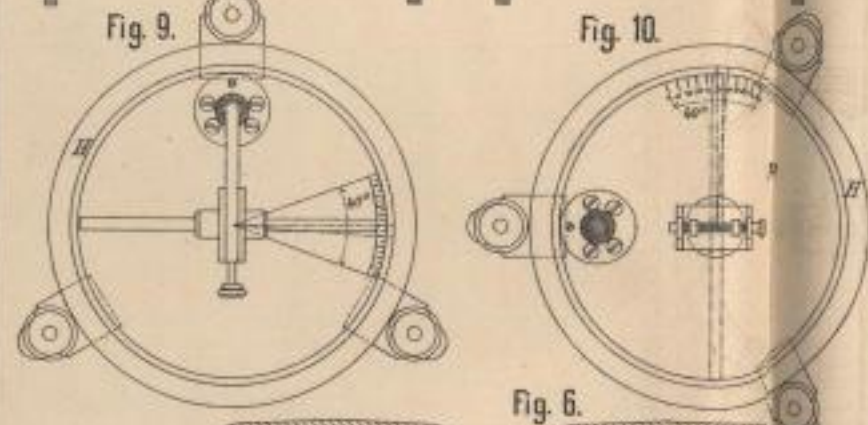
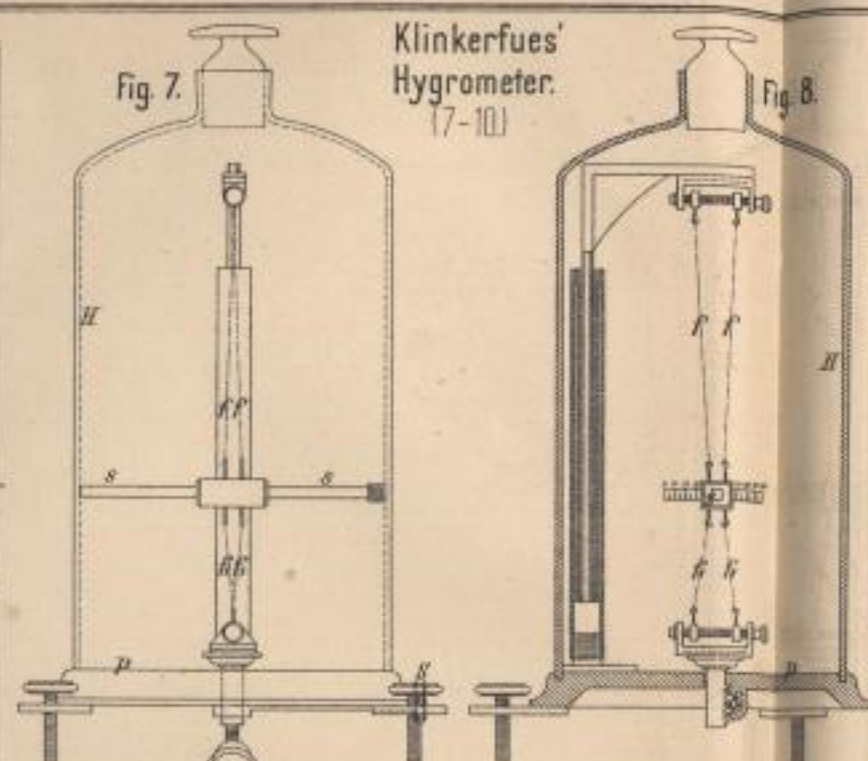
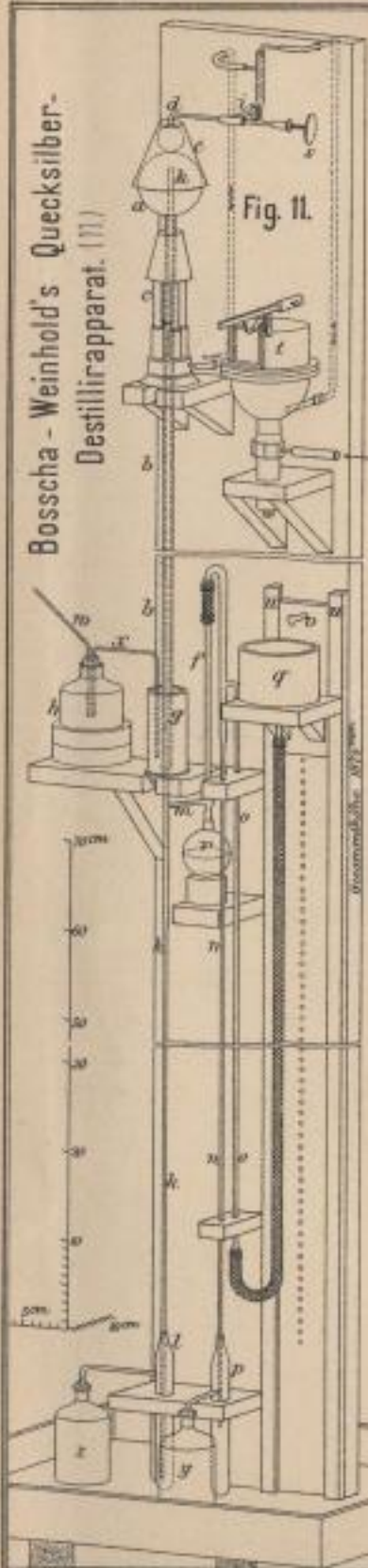

Verf. Joh. A. W. v. W. Darmstadt.



Sachse's Hohlbohrgestänge (1841)

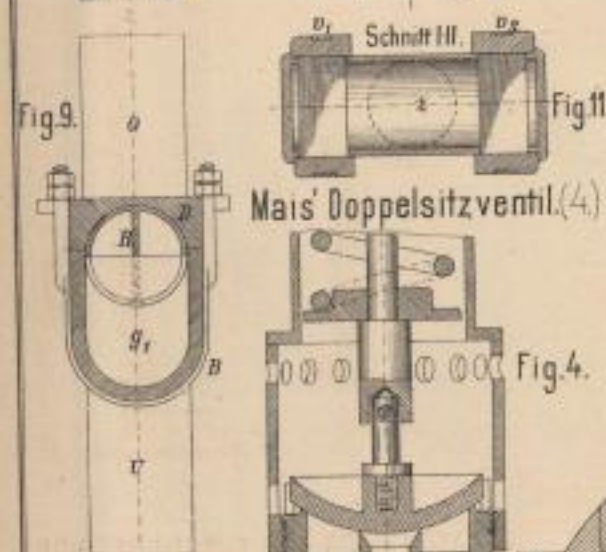
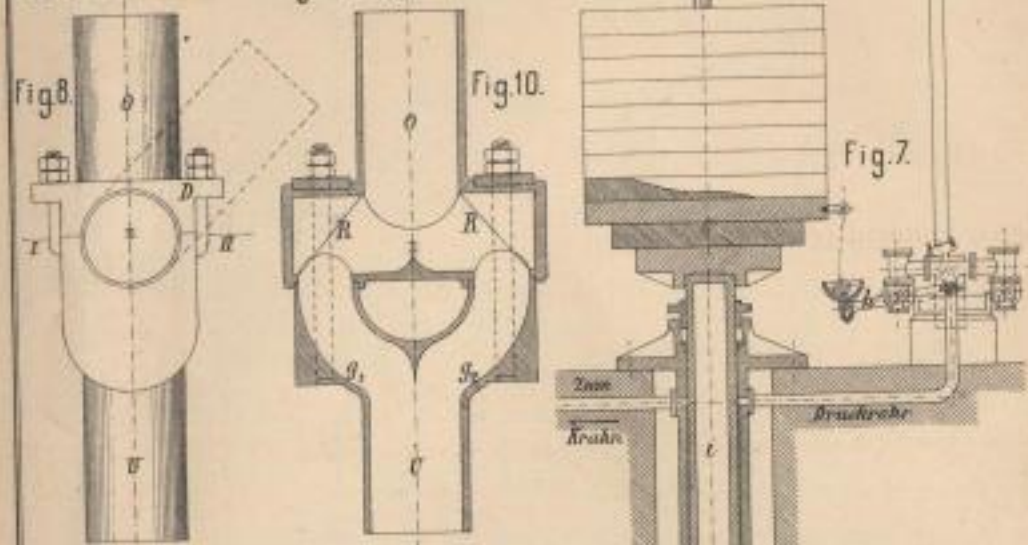

Mais' Doppelsitzventil (1844)

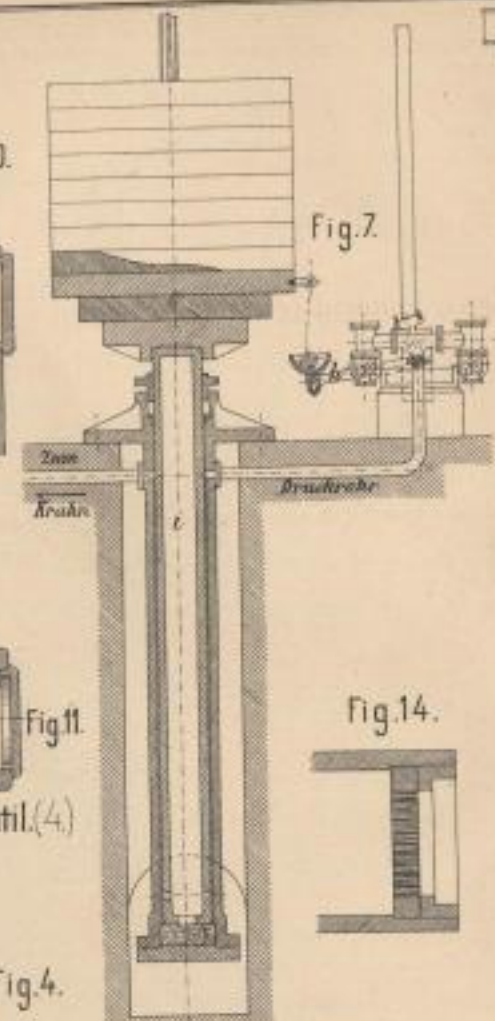

Fig. 14.

v. Binzer und Bentzen's Schiffsschraube (1831)

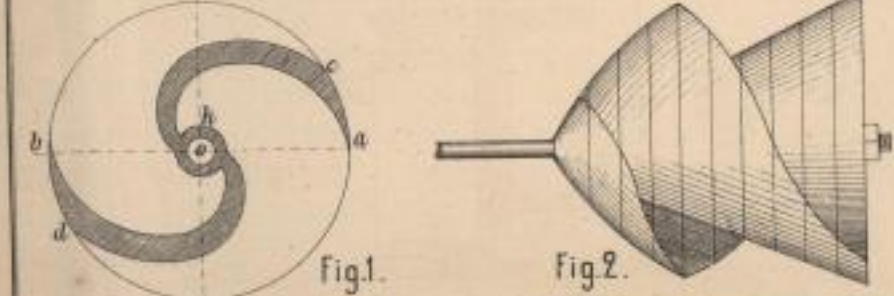

Fig. 1.

Fig. 2.

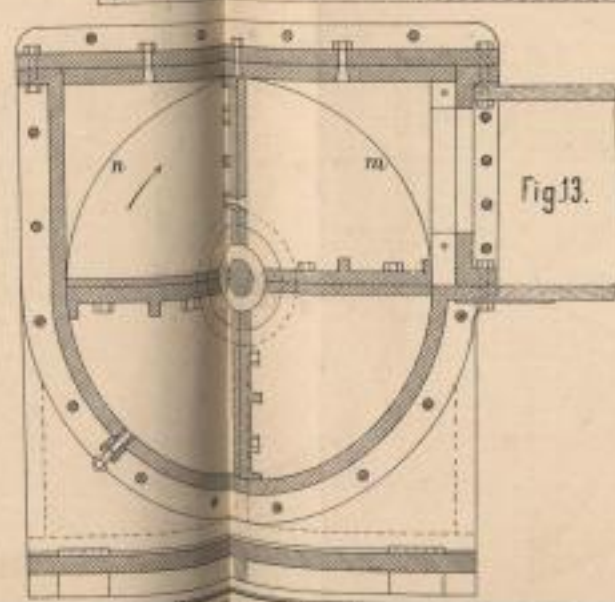

Fig. 13.

Lehr-Anstalt für Dampfmaschinenbau.

R. Daelen's hydraulischer Drehkrahnen (1857)

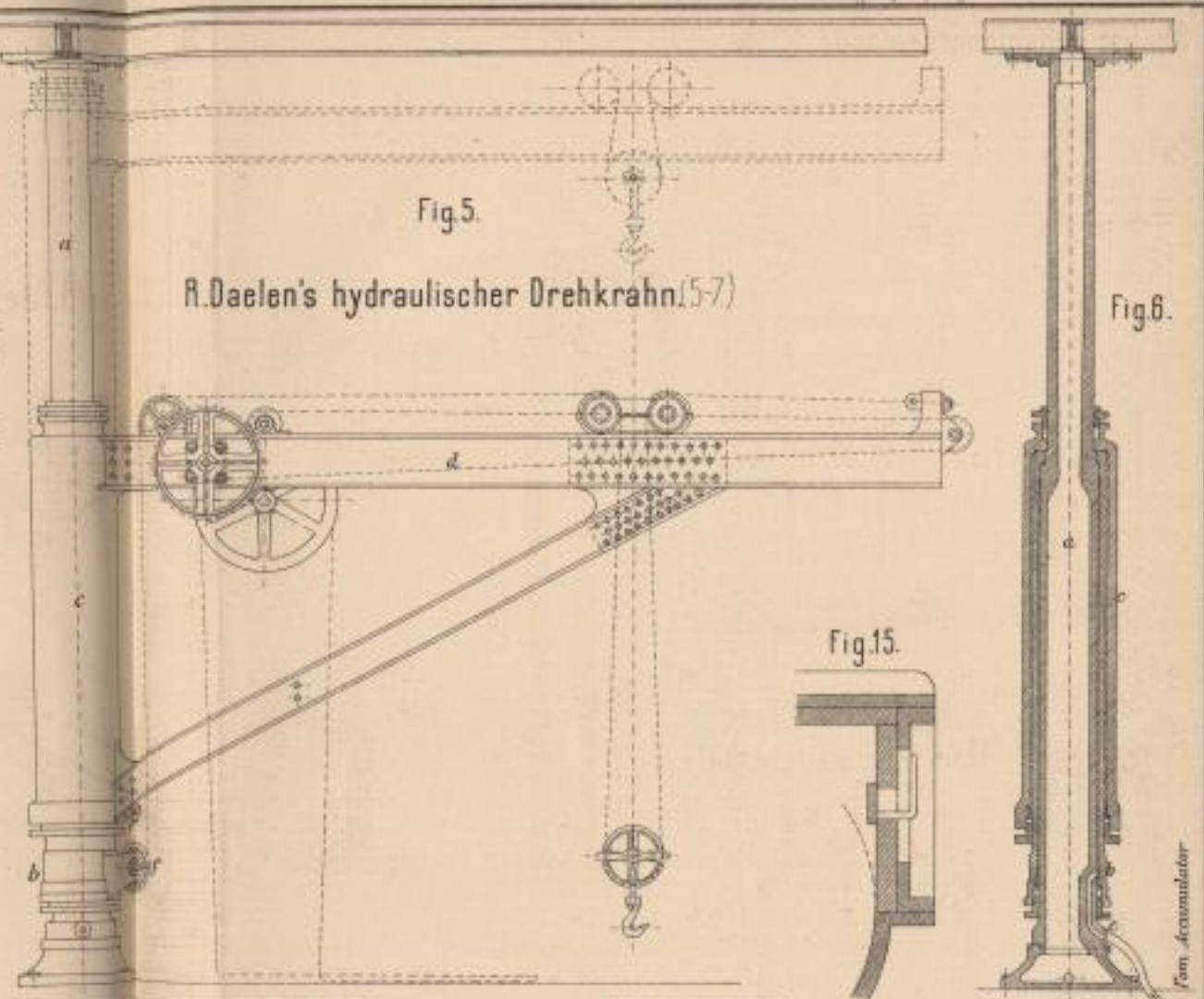

Fig. 5.

Fig. 6.

Fig. 15.

von Accumulator

Schiffner's Schleudermaschine (1815)

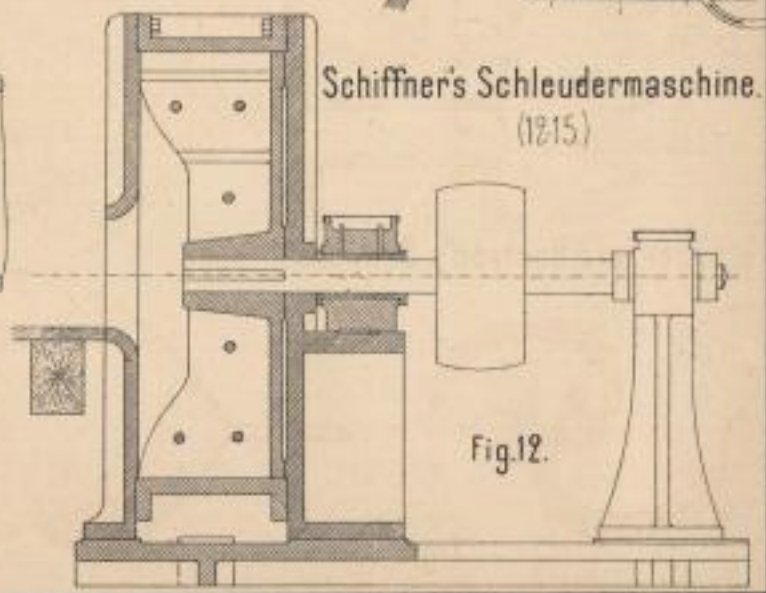
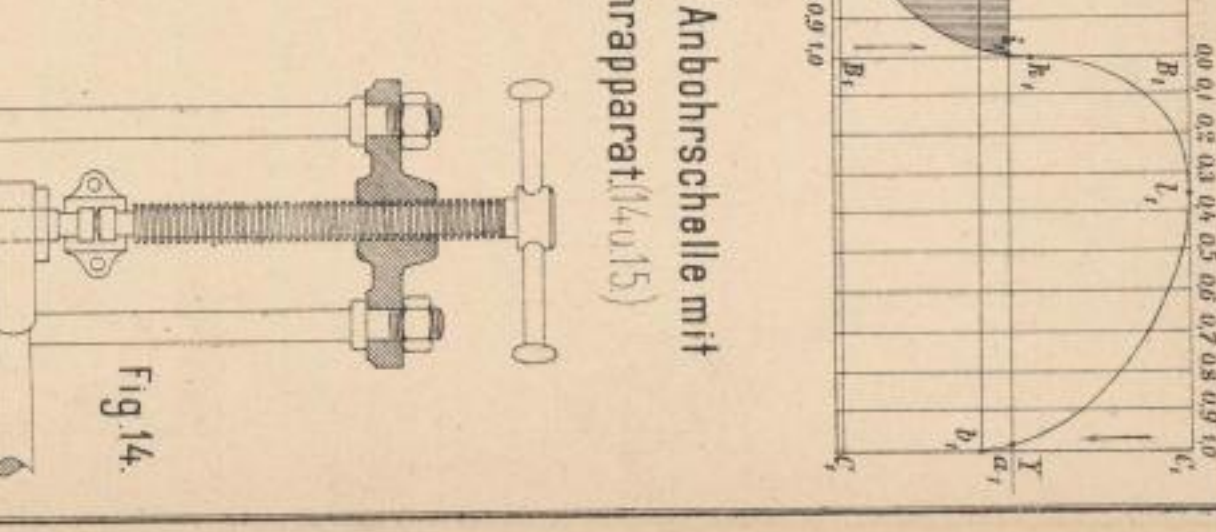
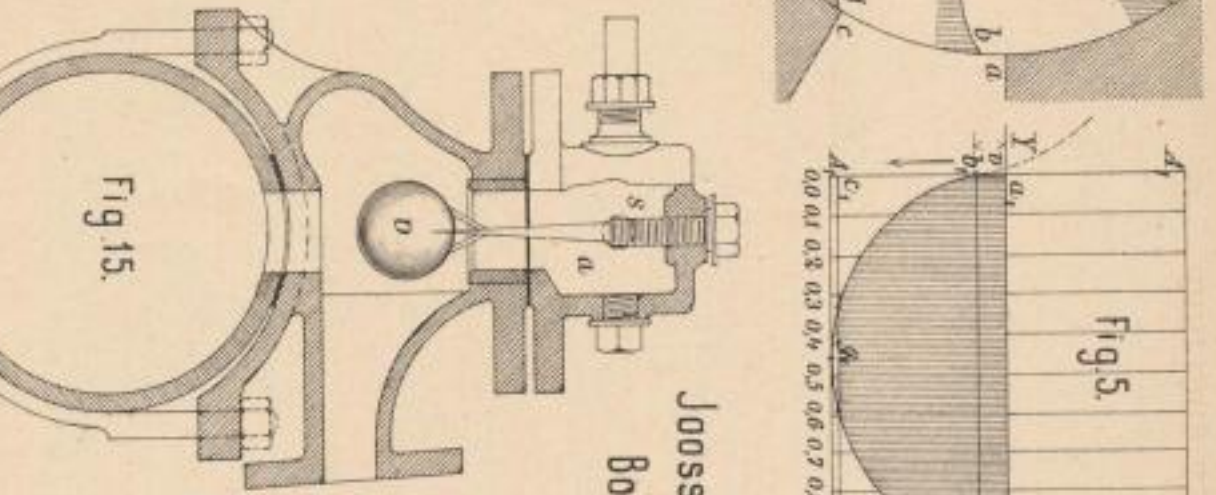
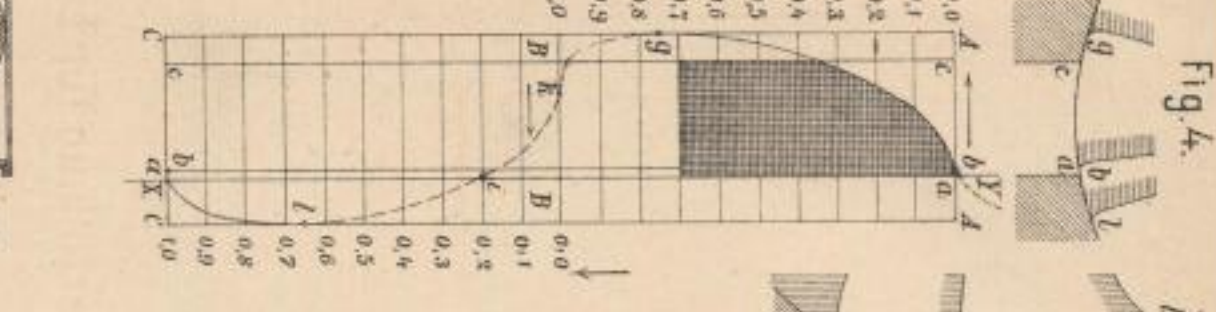
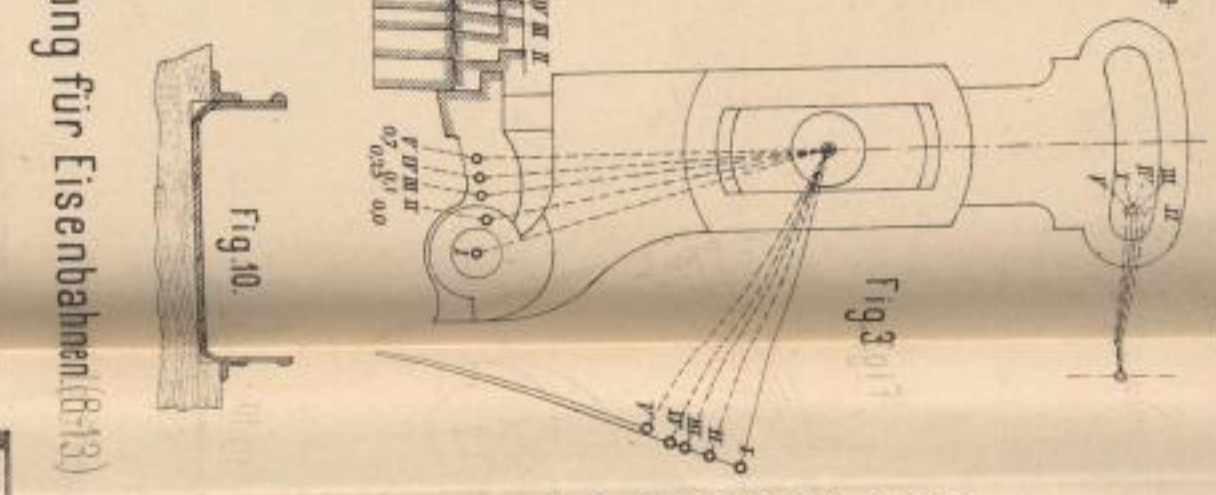
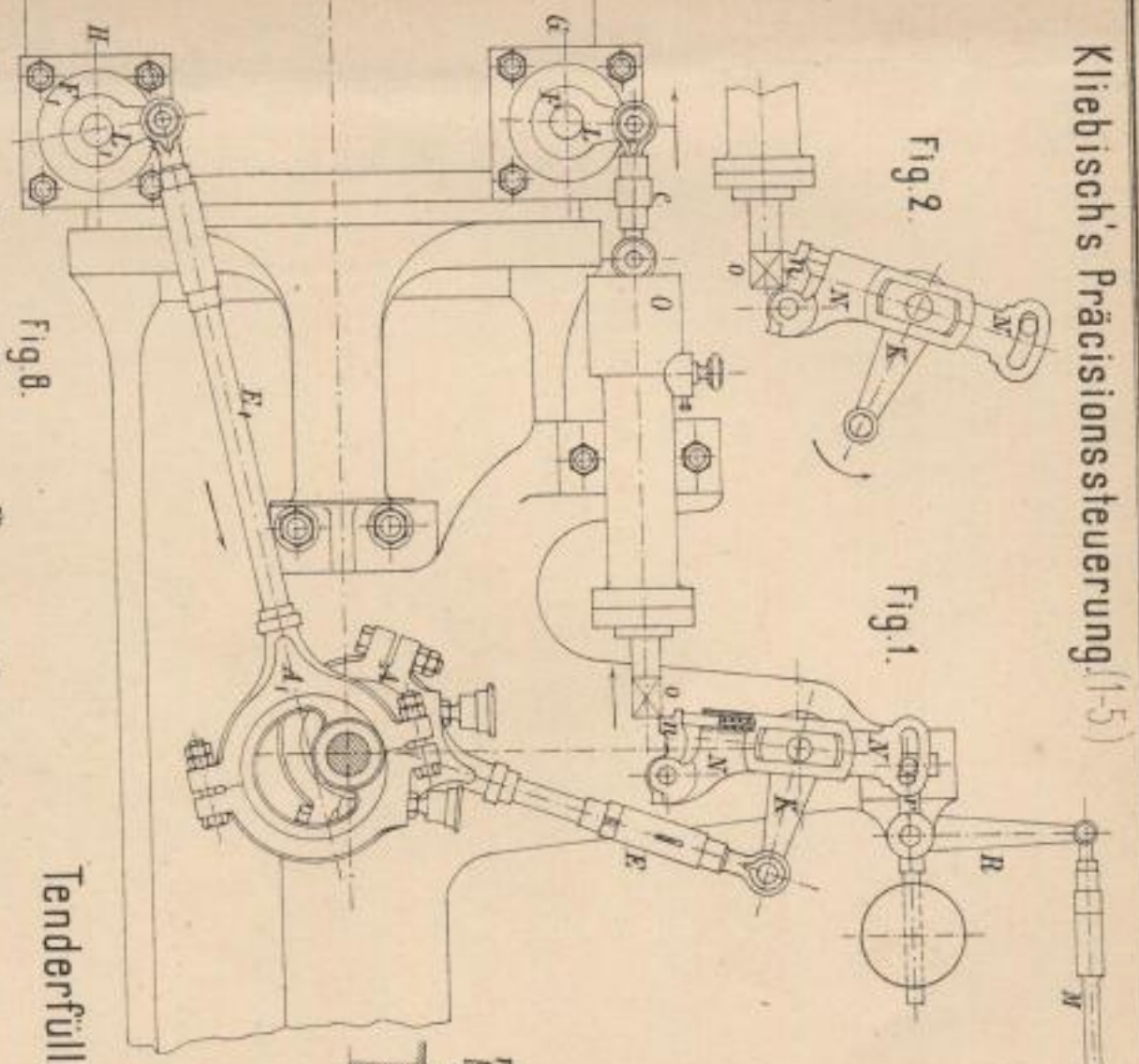

Fig. 12.



Kliebisch's Präzisionssteuerung (1-5)





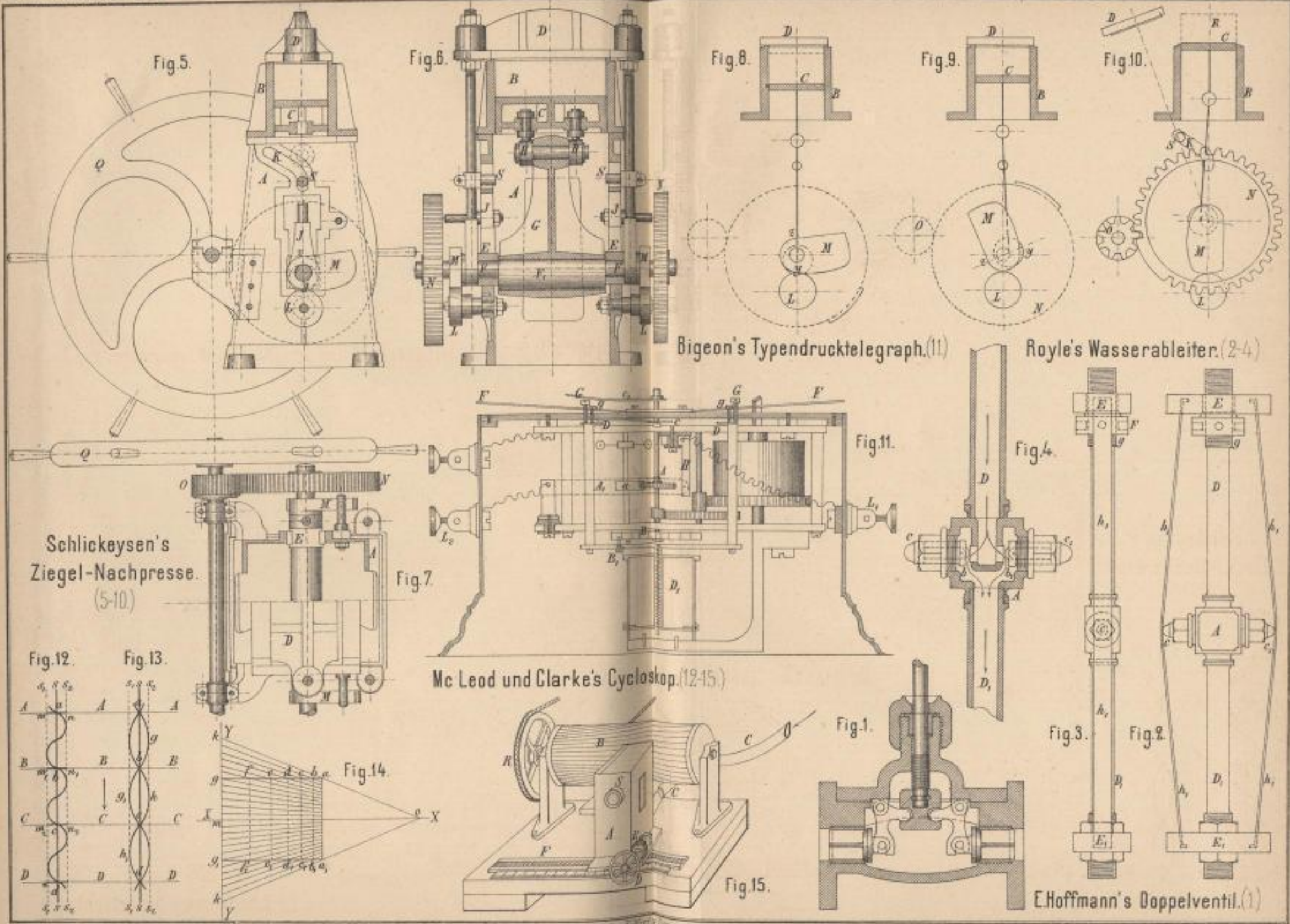

Fig. 5.

Fig. 6.

Fig. 8.

Fig. 9.

Fig. 10.

Bignon's Typendrucktelegraph. (11)

Royle's Wasserableiter. (2-4)

Schlickeysen's Ziegel-Nachpresse. (5-10)

Fig. 7.

Fig. 11.

Fig. 4.

Fig. 12.

Fig. 13.

Mc Leod und Clarke's Cyclooskop. (12-15.)

Fig. 1.

Fig. 3.

Fig. 2.

Fig. 15.

E. Hoffmann's Doppelventil. (1)

Lith. Anst. v. J. Neumann, Neudamm.



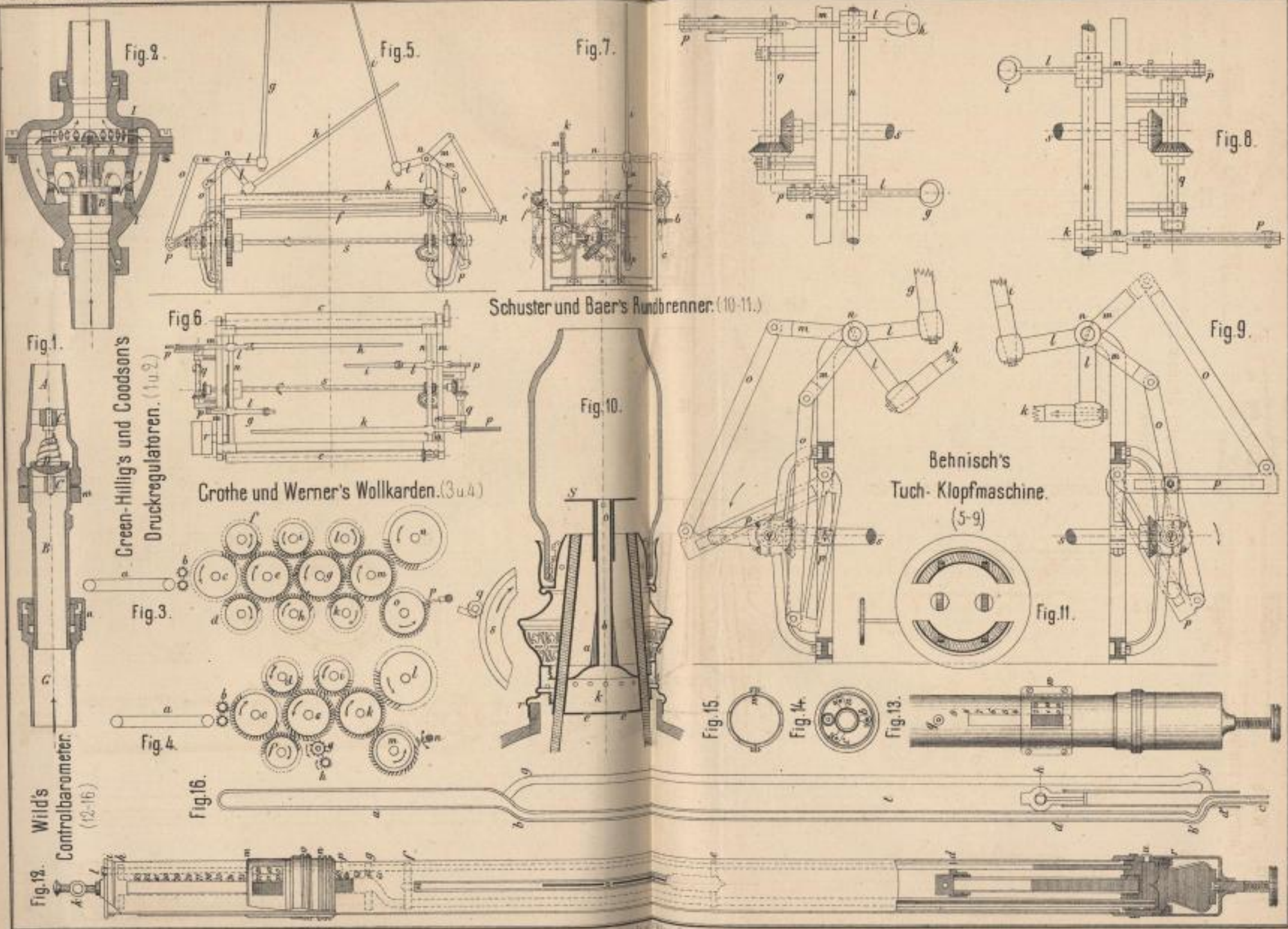

Leh. Anst. v. H. v. Bernstedt



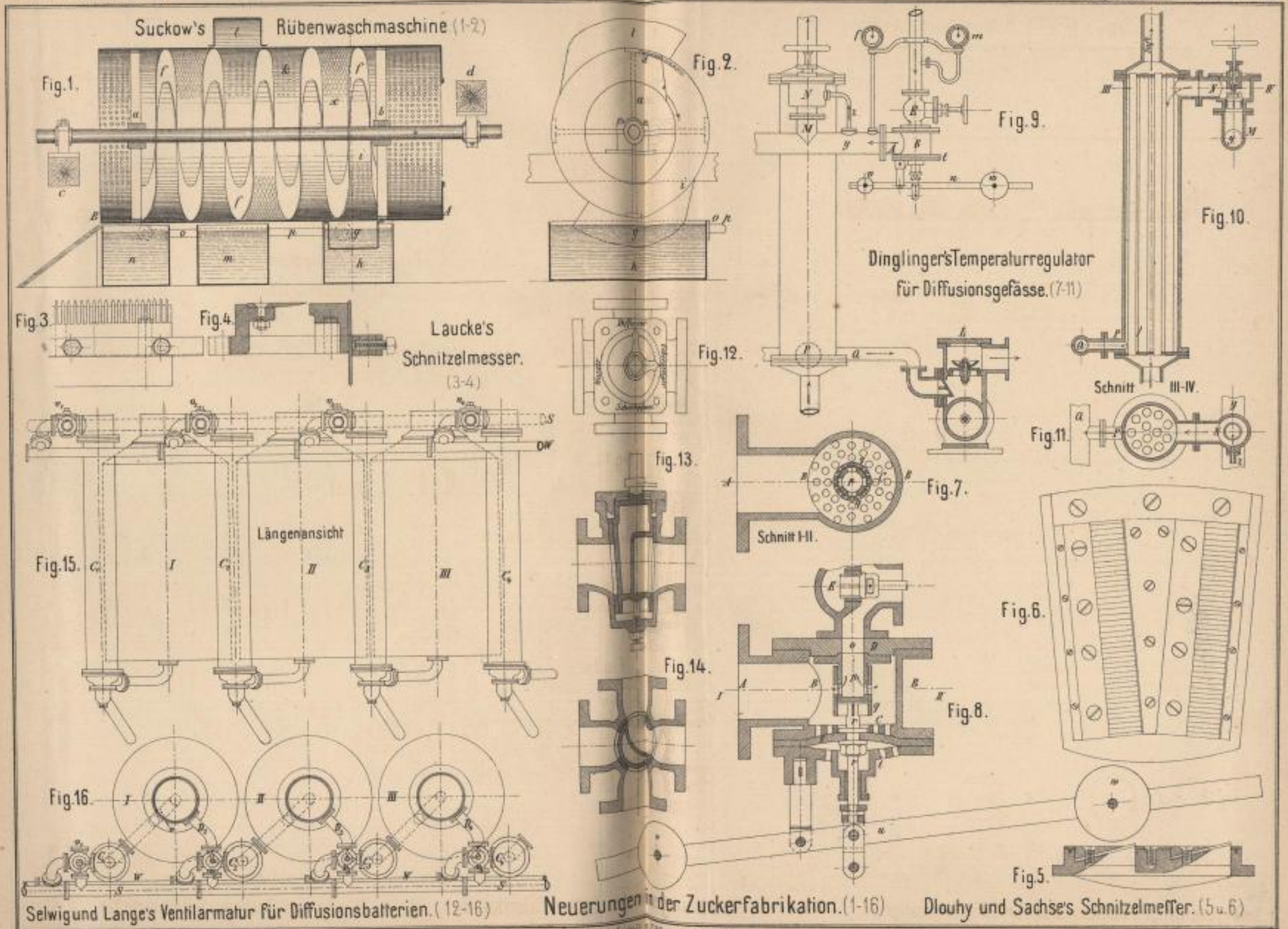

Neuerungen in der Zuckerfabrikation. (1-16)

Dlouhy und Sachs's Schnitzmesser. (5 u. 6)

*Lith. Anstalt v. W. Barmstadt*



Darstellung der kohlensauren Alkalien mittels Trimethylamin (5-8.)

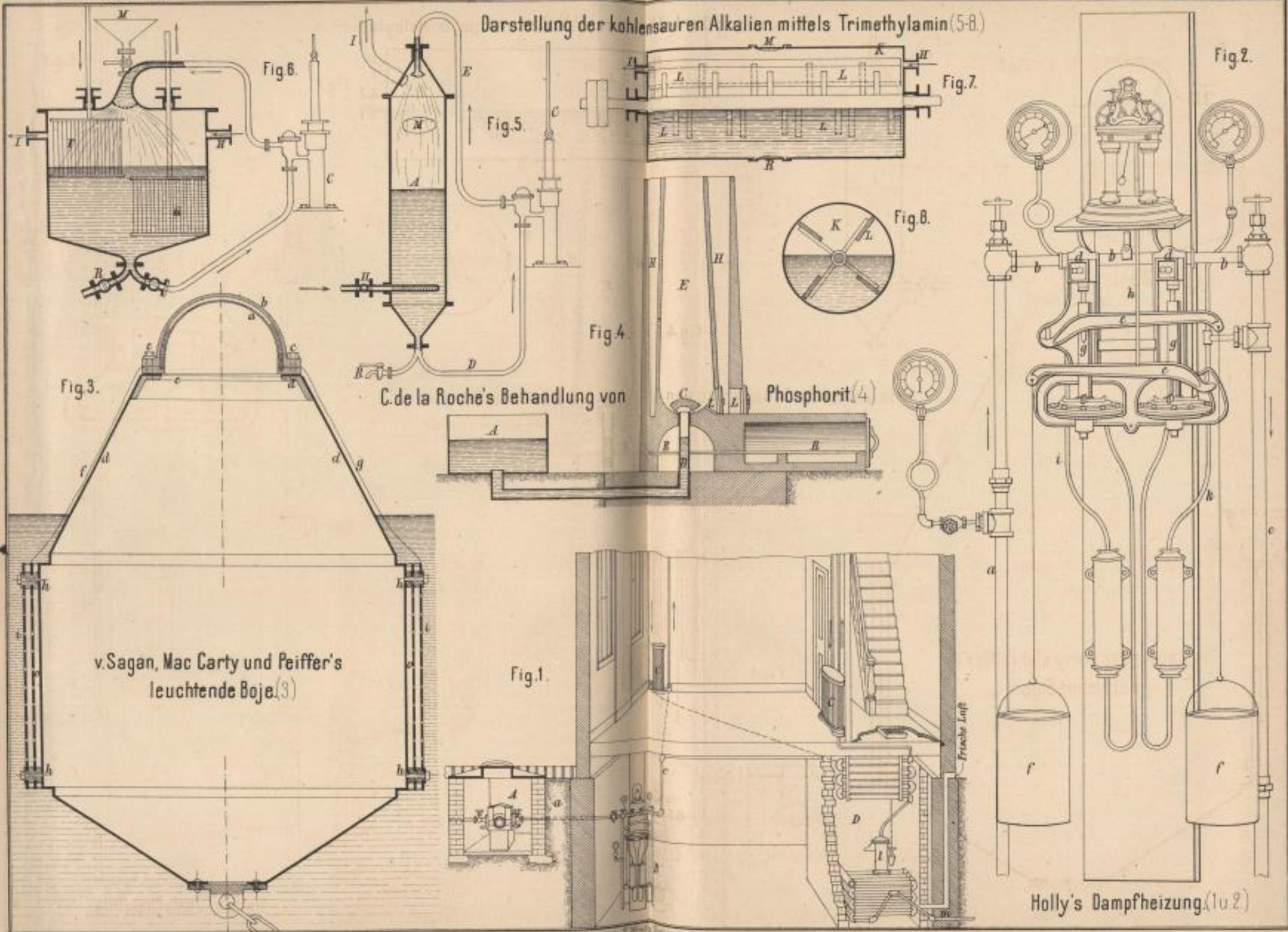

Lith. Anst. v. J. Neumann, Neudamm.



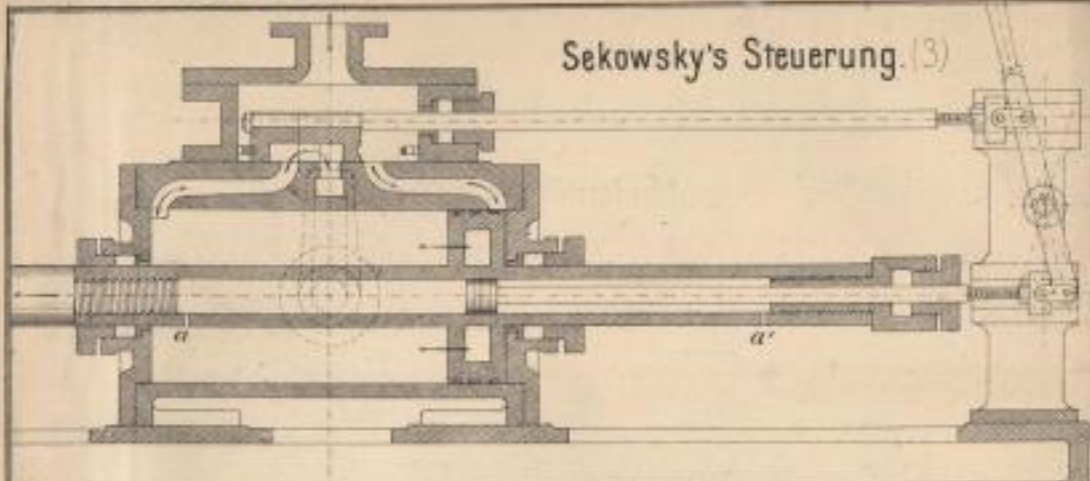

Sekowsky's Steuerung. (3)

Fig. 3



Schäffer und Budenberg's Dreiweghahn. (5-7)

Fig. 5.

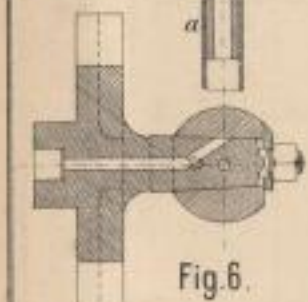

Fig. 6.

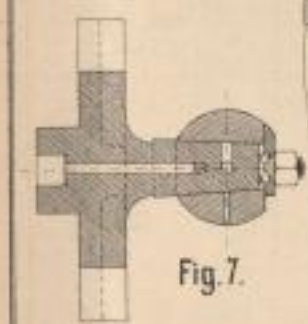

Fig. 7.

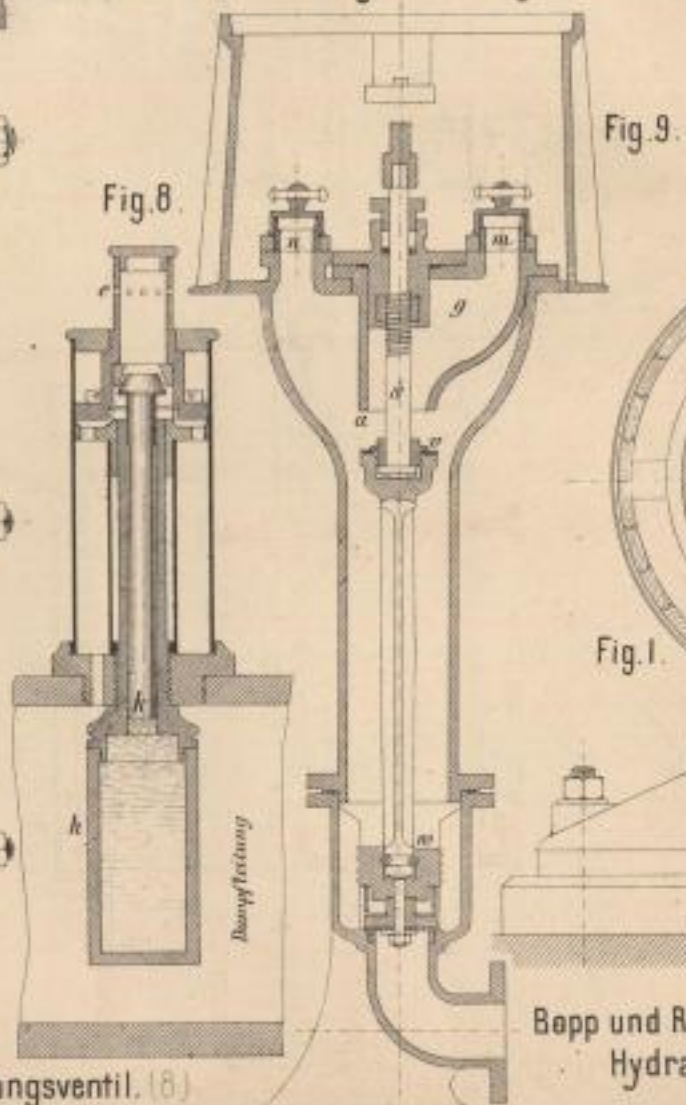
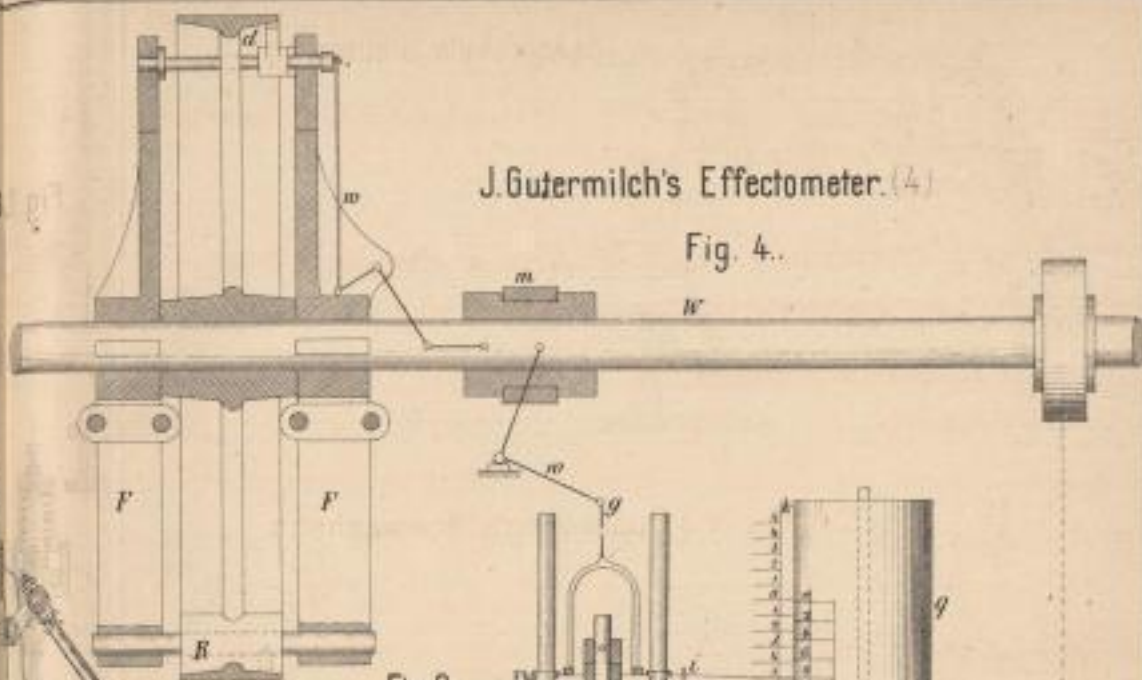

Fig. 9.

Bopp und Reuther's Hydrant. (9)



J. Gutermilch's Effectometer. (4)

Fig. 4.

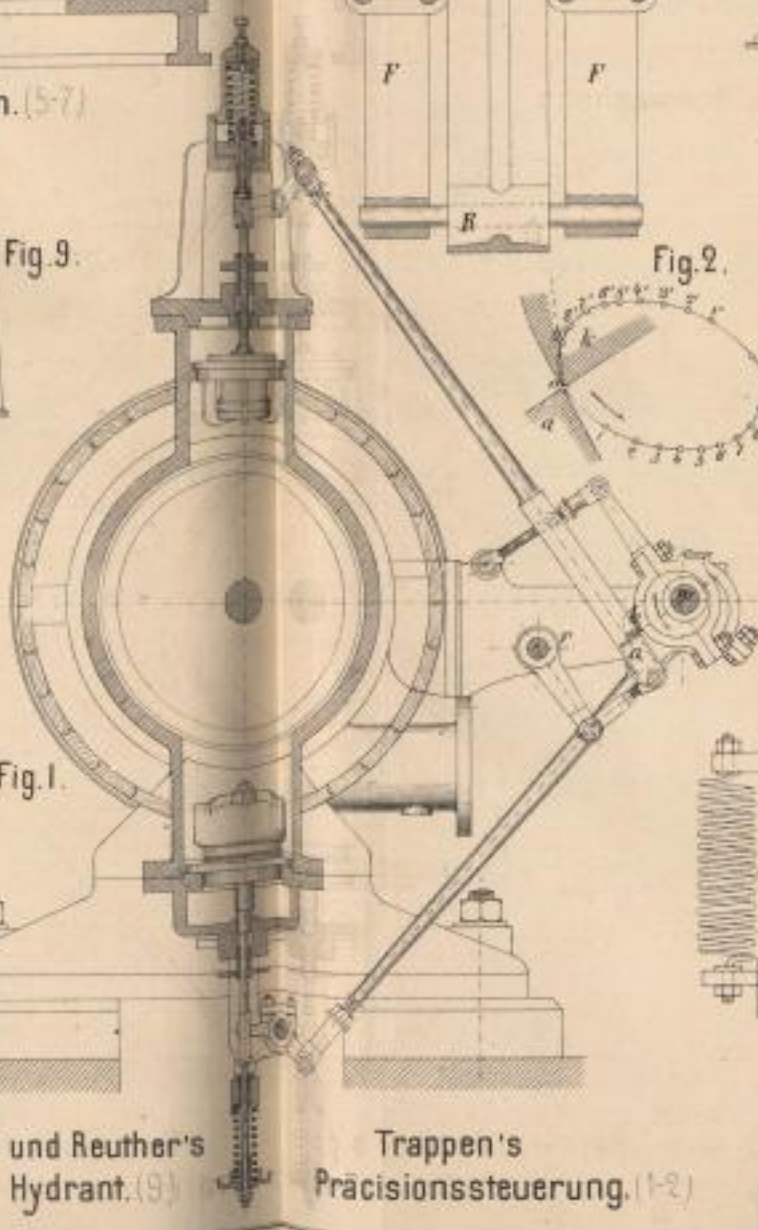
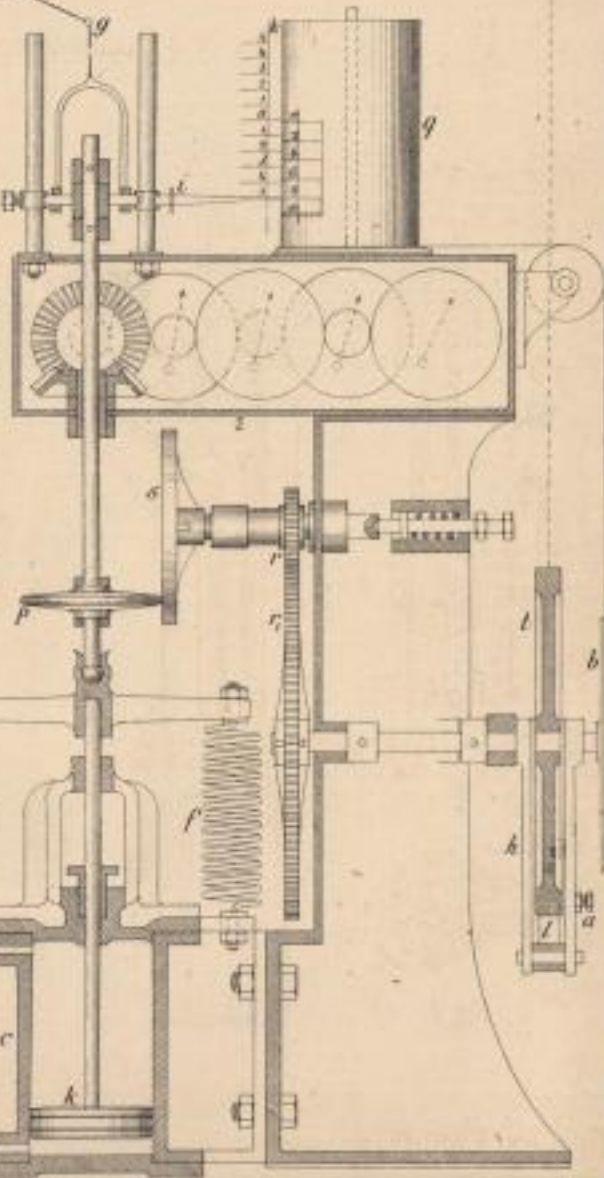

Fig. 1.

Trappen's Präzisionssteuerung. (1-2)



Grove's Entlüftungsventil. (8)



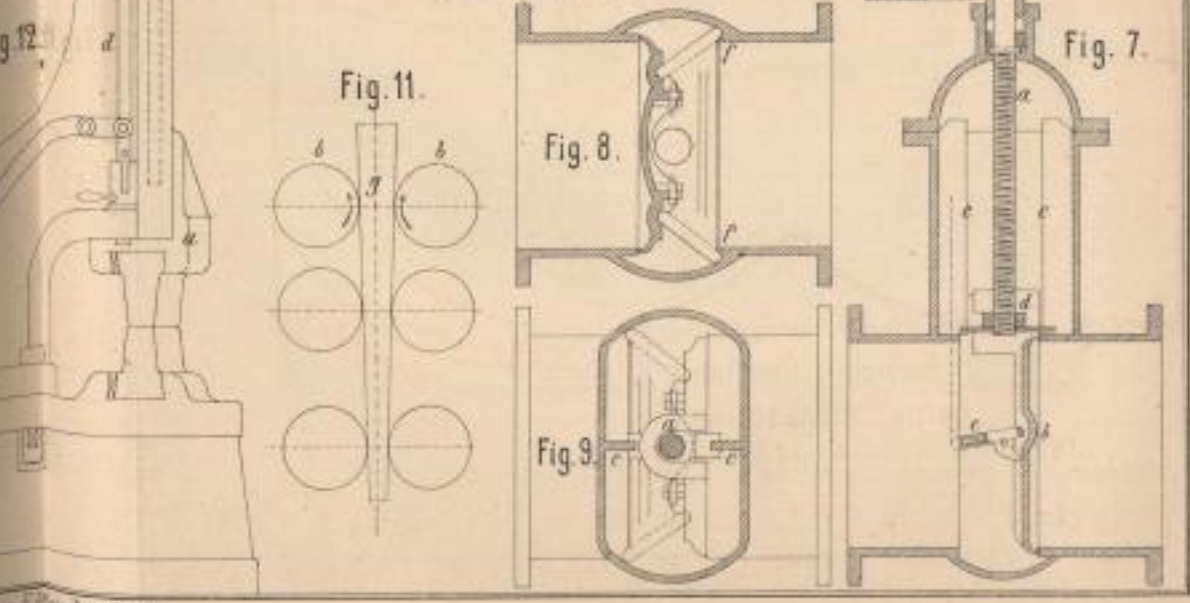
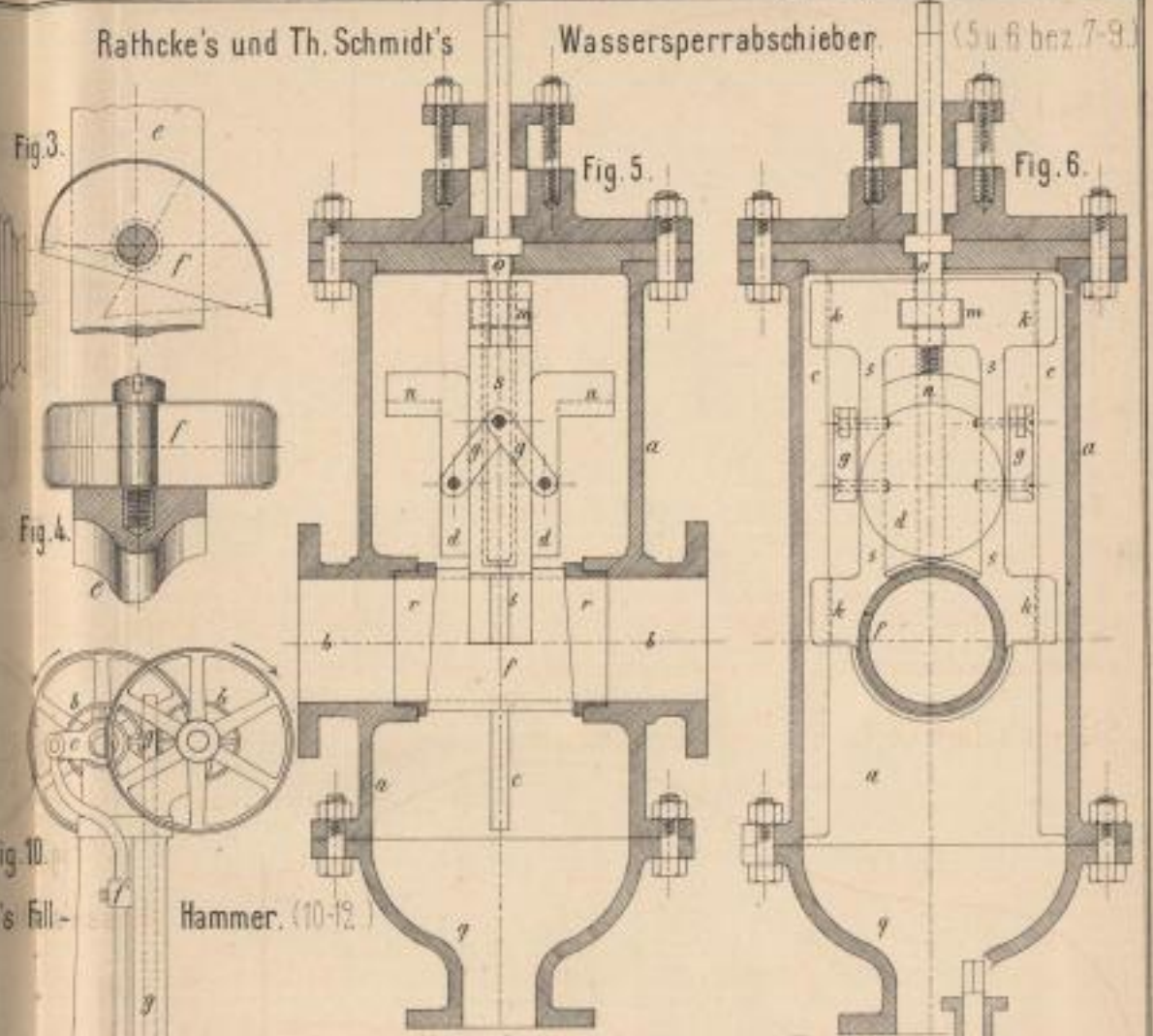
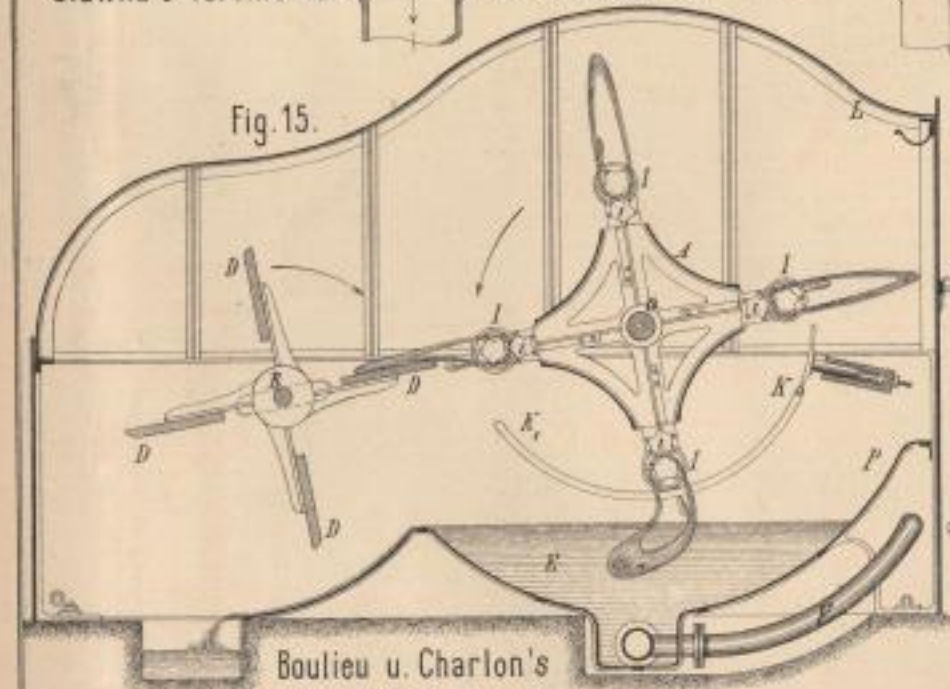
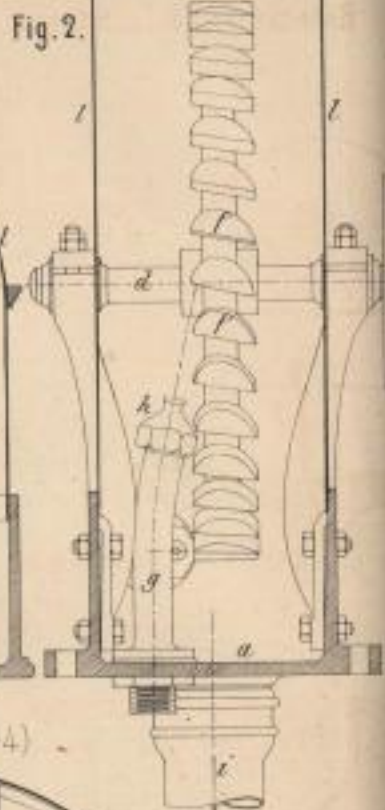
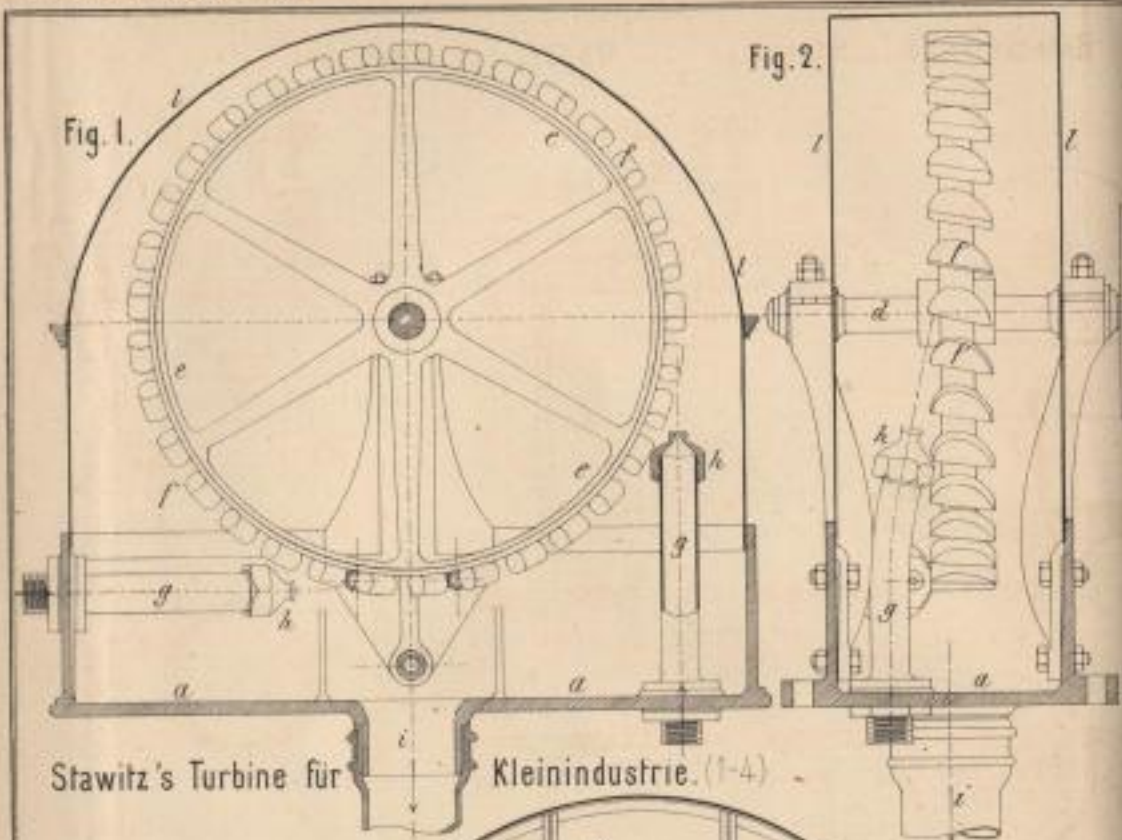

Lith. Anstalt von F. W. Dornmüller



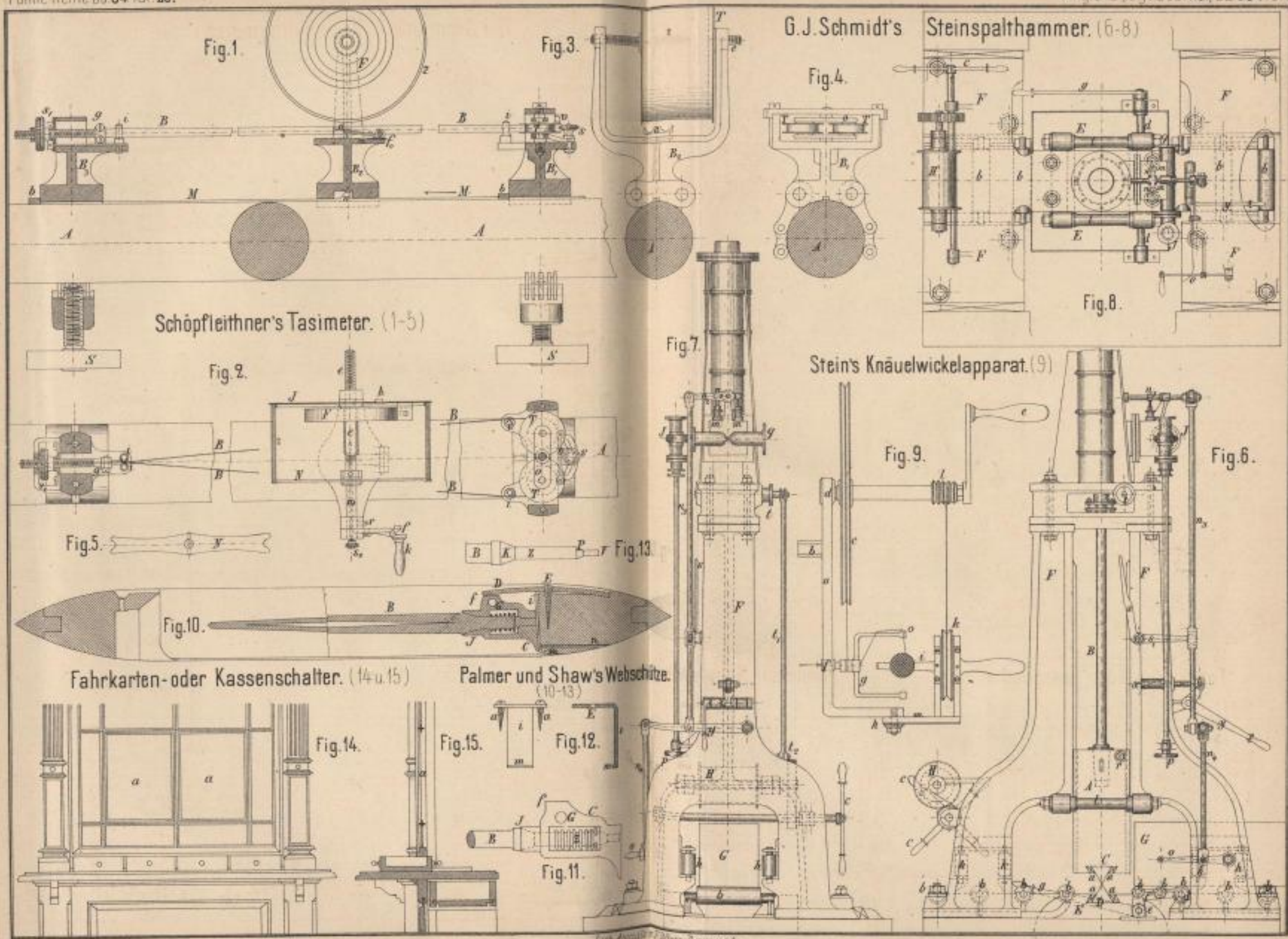

Schöpfleithner's Tasimeter. (1-5)

G. J. Schmidt's Steinspalthammer. (6-8)

Fahrkarten- oder Kassenschalter. (14 u. 15)

Palmer und Shaw's Webschütze. (10-13)

Stein's Knäuelwickelapparat. (9)

Lith. Anstalt v. W. Baumbach



Hipp's elektrische Uhr (7-11)

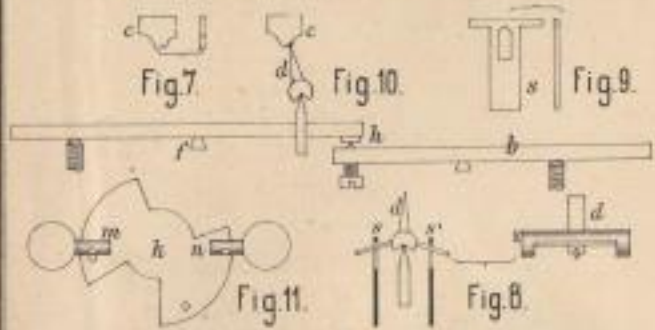

Forbes' Grubengas-Anzeiger (12)

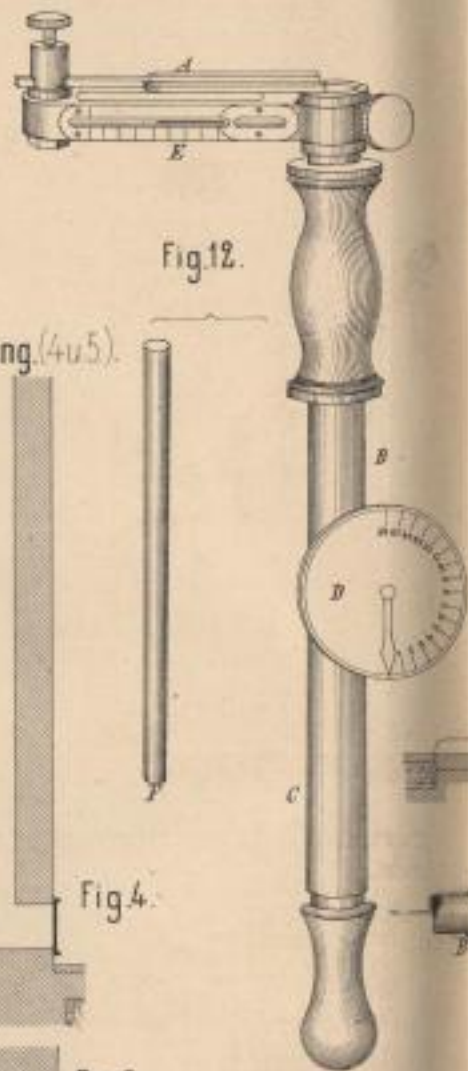

Fischer und Stiehl's Feuerung für Heisswasser-Heizung (4 u 5)

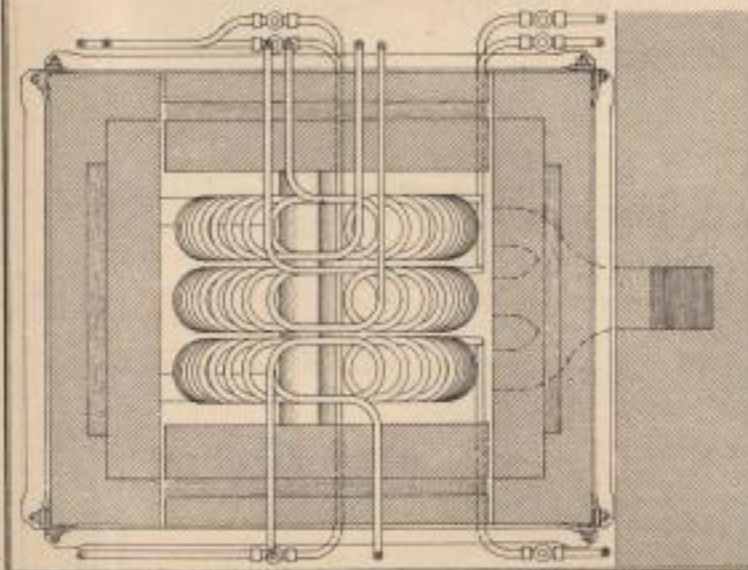
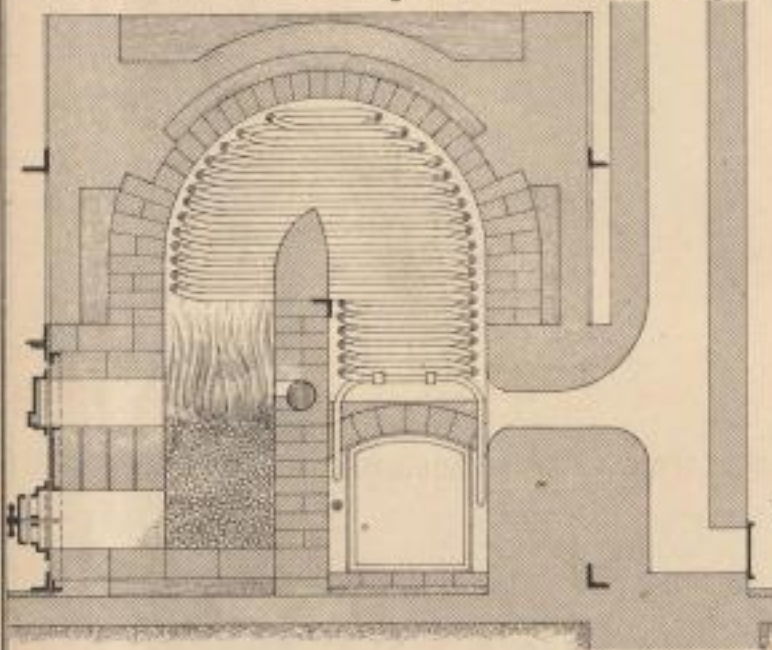

Fig. 5

Achard und Treve's Steuermechanismus (13 u 14)

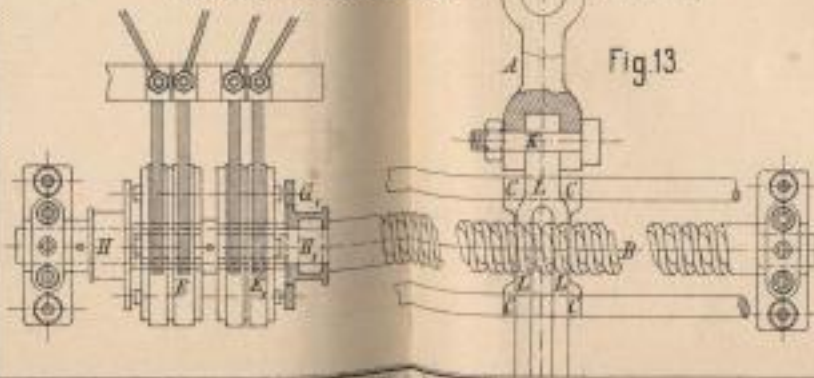

Fig. 13

Fig. 14

Erwärmung von Eisenbahn-Wärmflaschen (1-3)

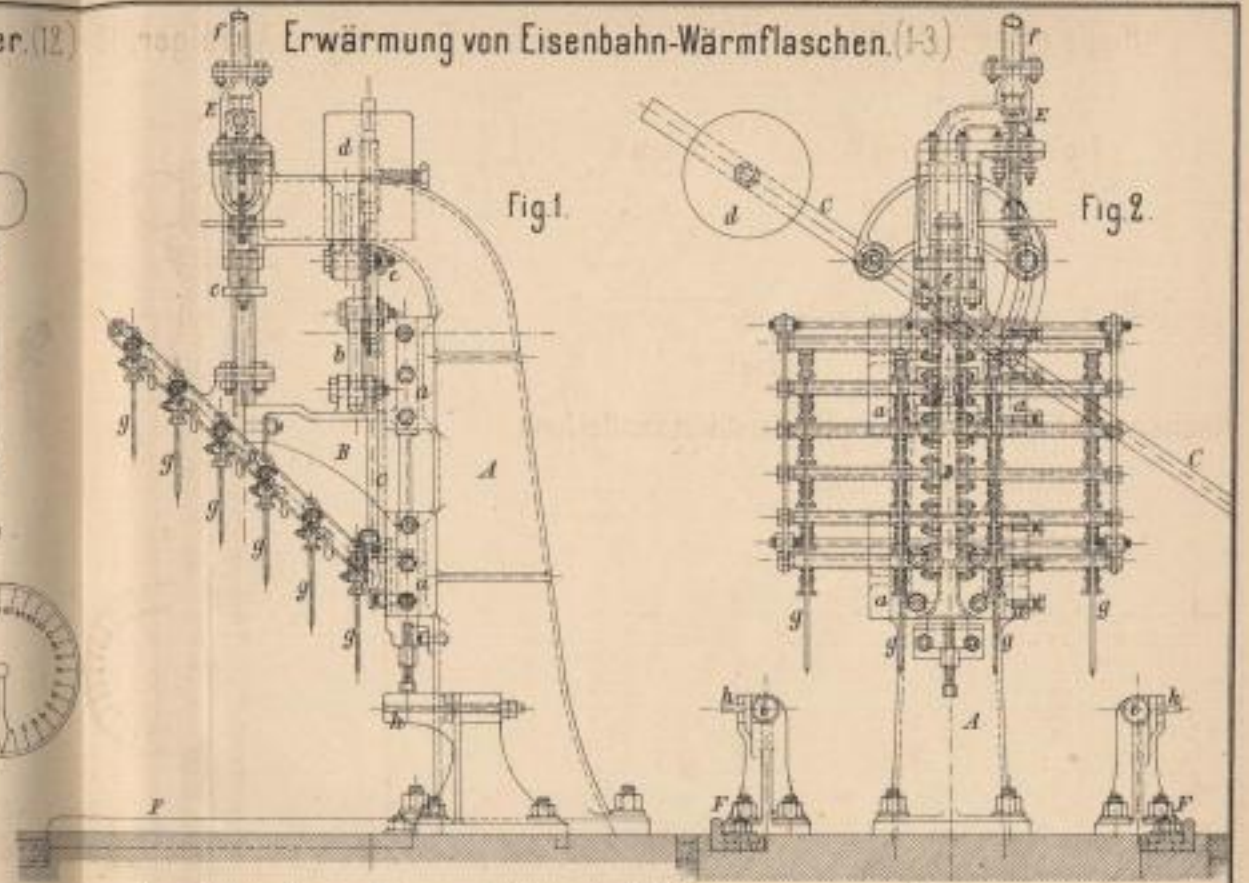

Fig. 1

Fig. 2

Horn und Lorenz's Wärmeregulator (6)

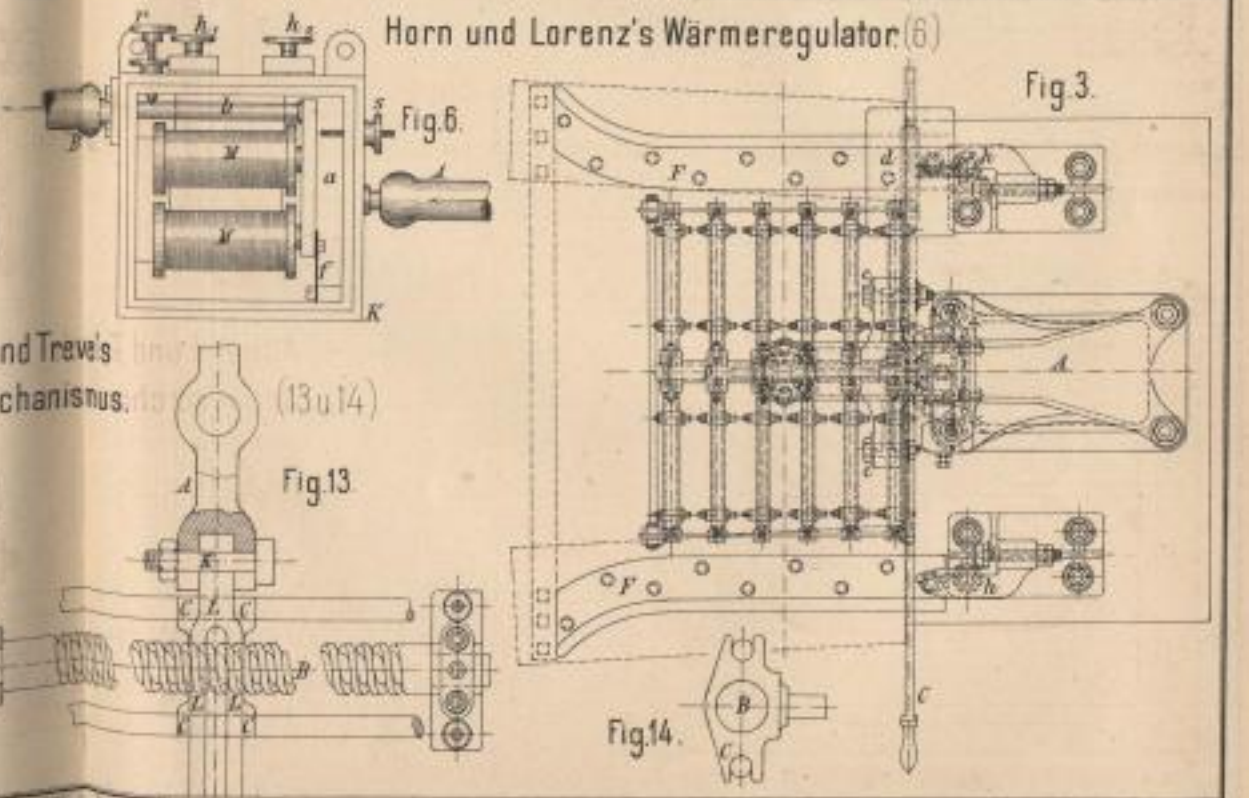

Fig. 3

Fig. 6

Lith. Anst. v. F. W. Junemann



# Neuerungen in der Zuckerfabrikation. (Taf. 30 u. 31)

V. Nowotny's Diffuseur. (2)    Bergreen's Schnitzelpresse. (3)

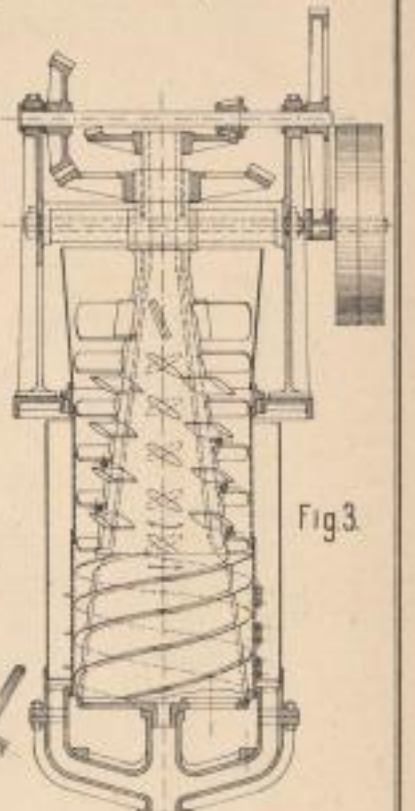
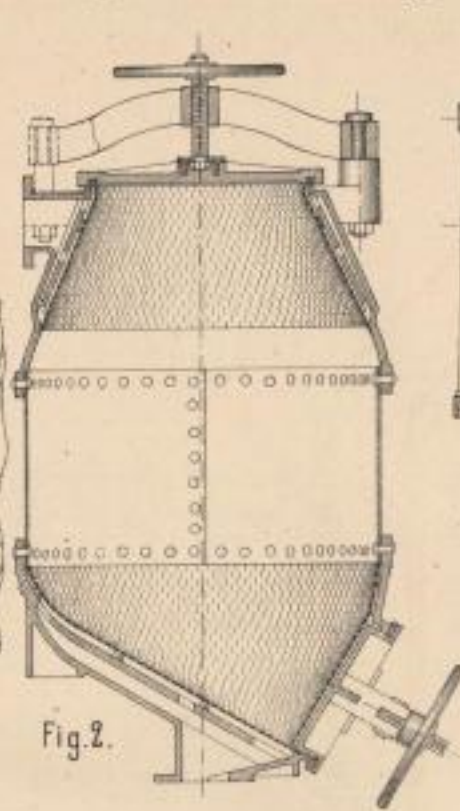
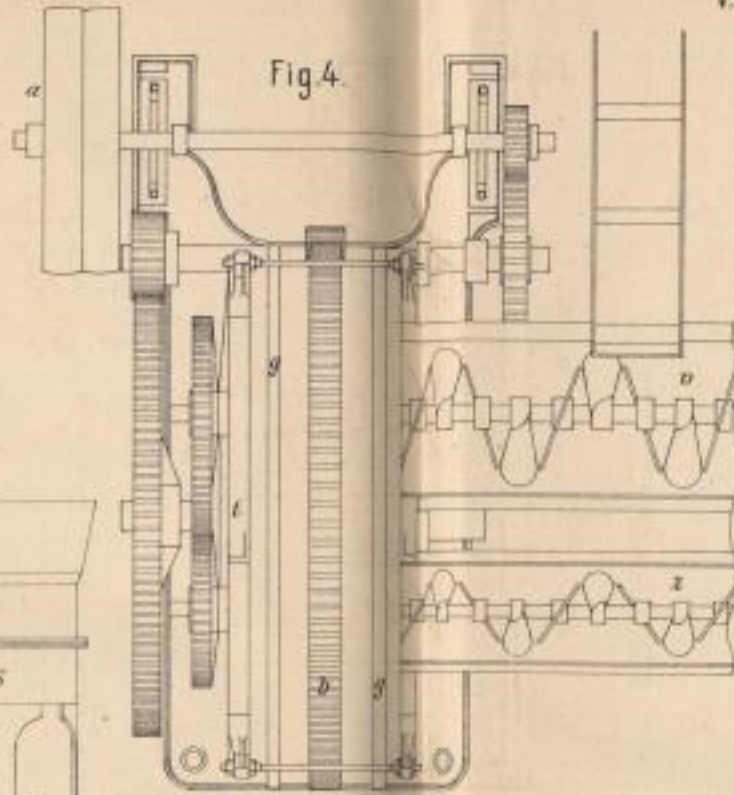
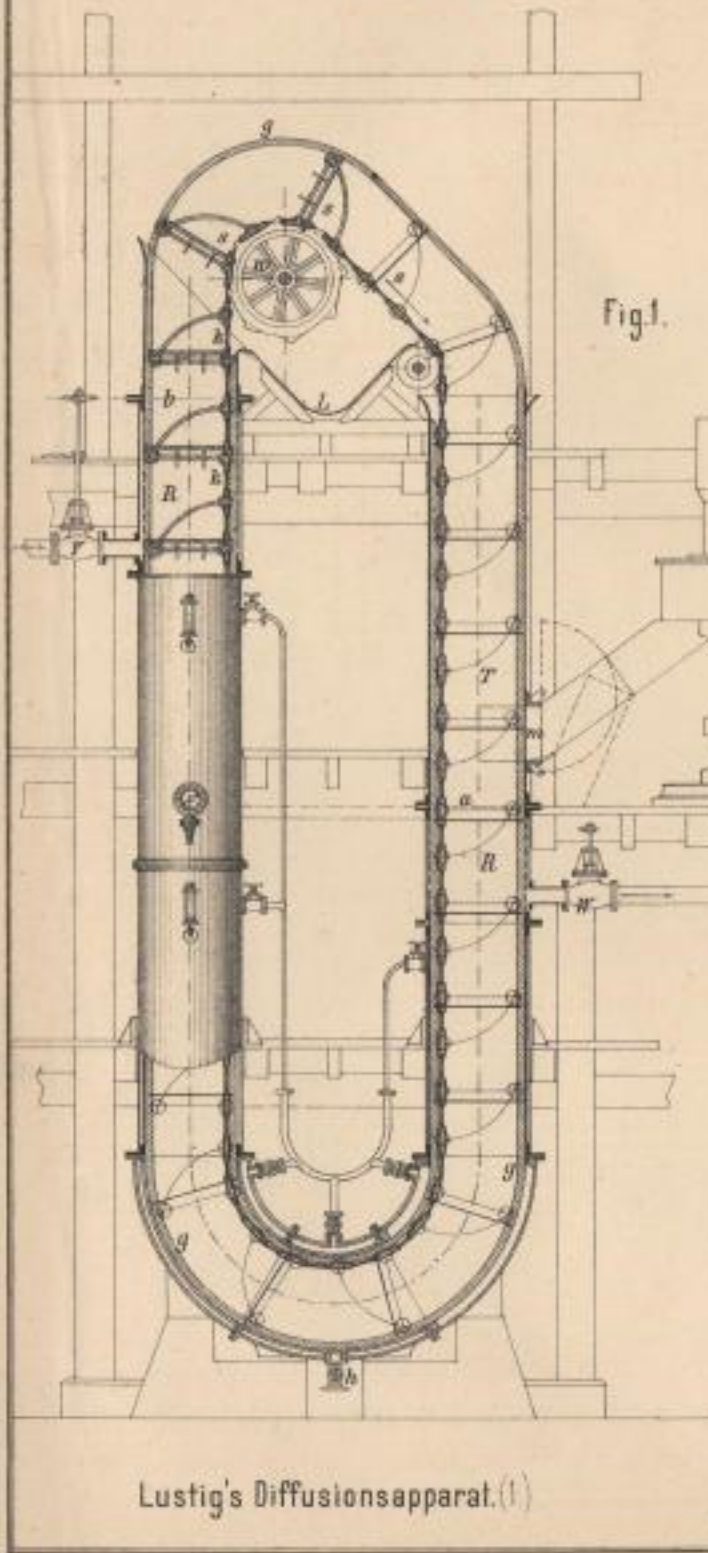

Haase's Schnitzelpresse. (4-6 Vgl. Fig. 1 u. 2 Taf. 31.)

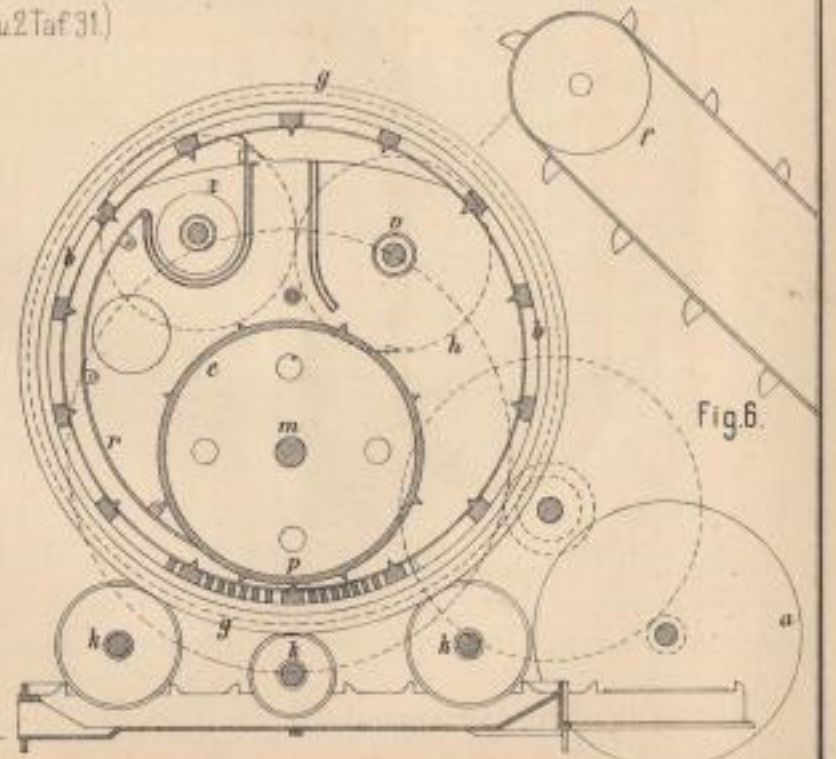
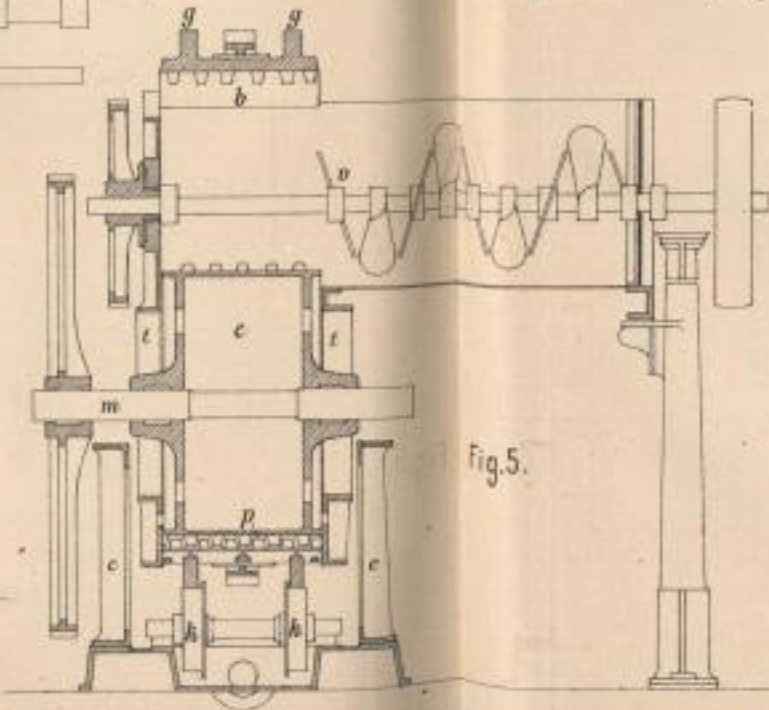

Lith. Anst. v. F. W. Neumann



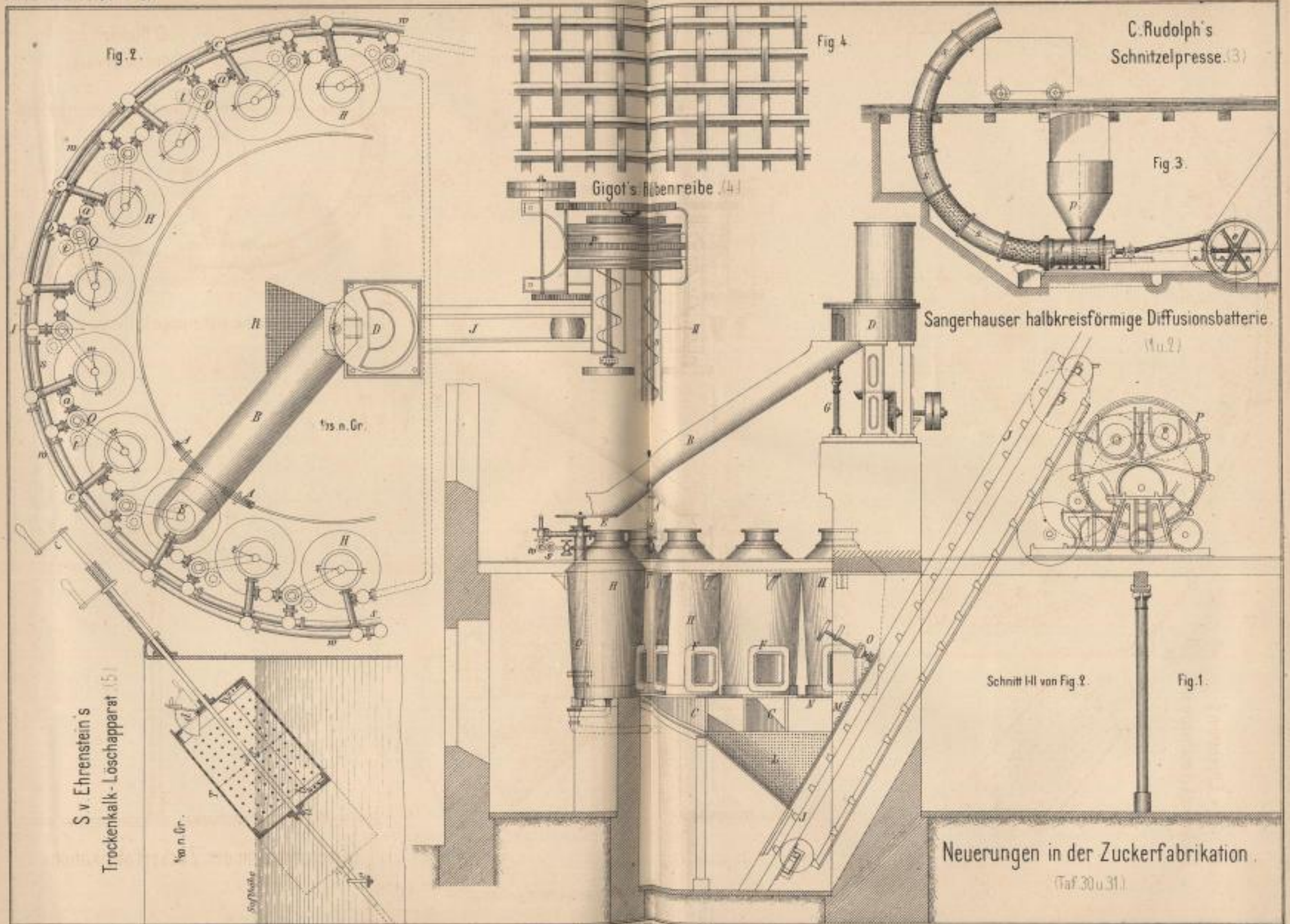

Neuerungen in der Zuckerfabrikation.  
(Taf. 30 u. 31.)

Lith. Anst. v. F. W. B. Dornstadt.



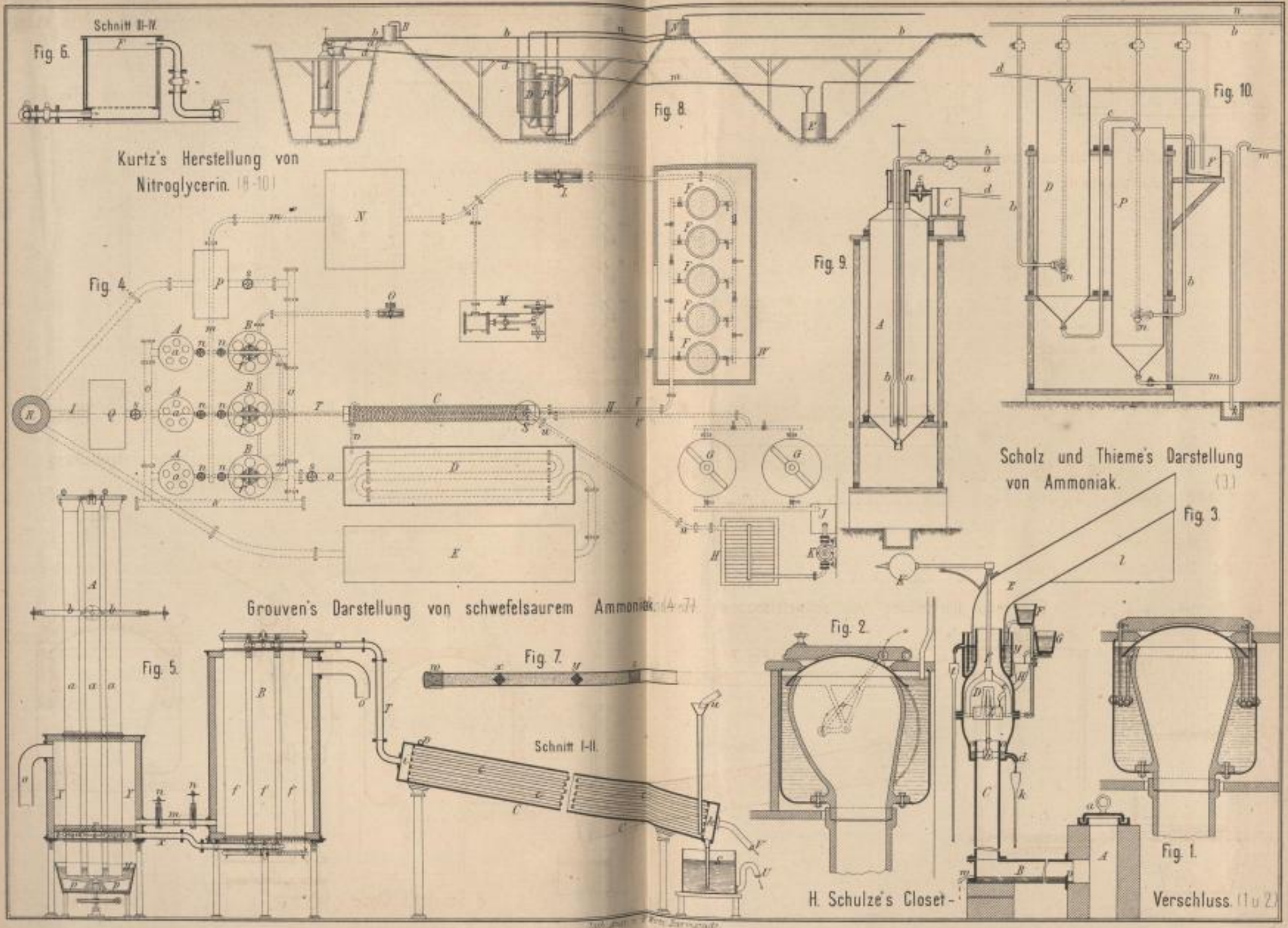



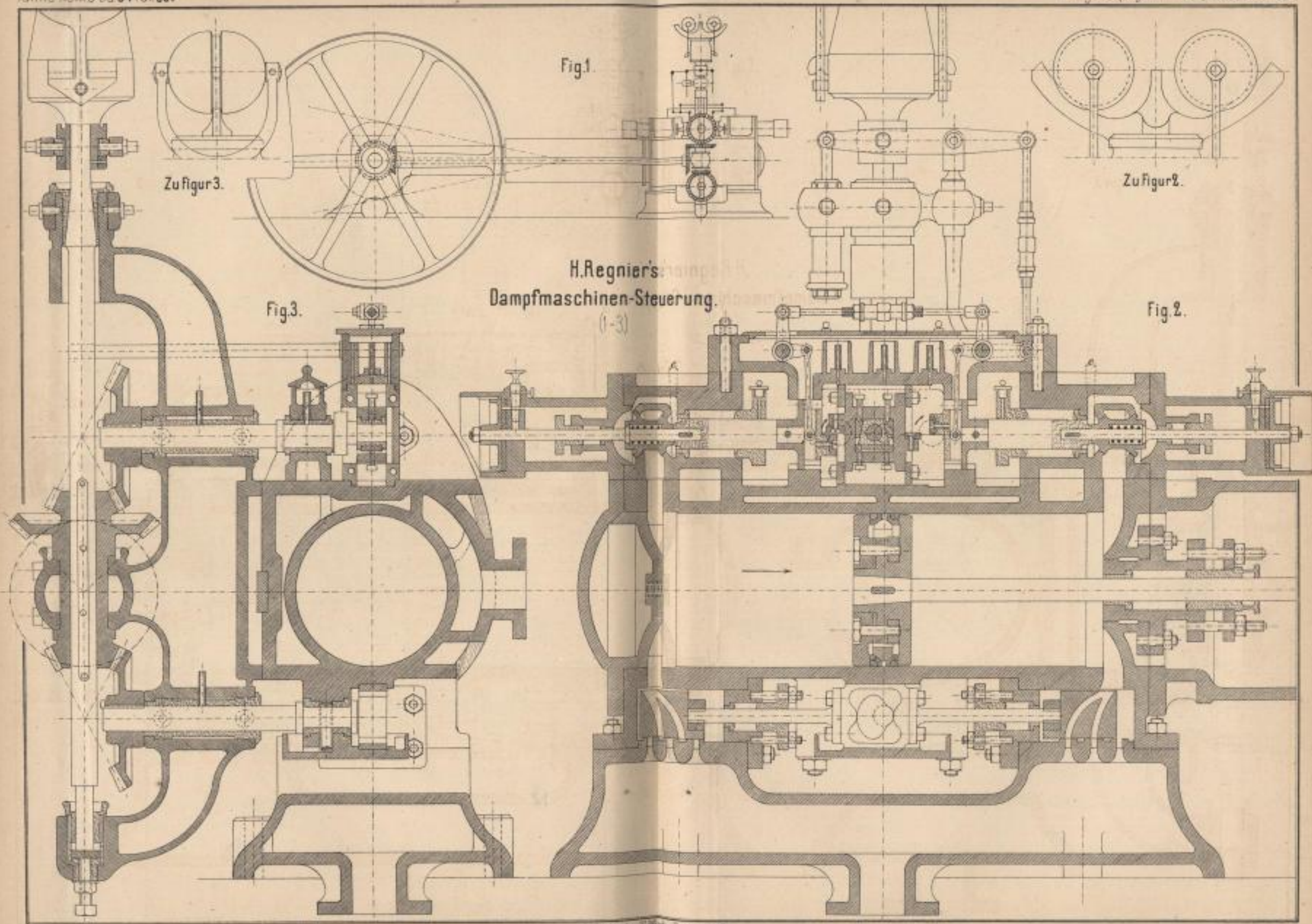

H. Regnier's Dampfmaschinen-Steuerung. (1-3)

Zoth. Anstalt in Witten-Darmstadt.



Lilie und Werner's Wassersäulenmaschine. (6-10.)

Waterous' Sicherheitsventil und Funkenfänger. (3u4 bez 5)

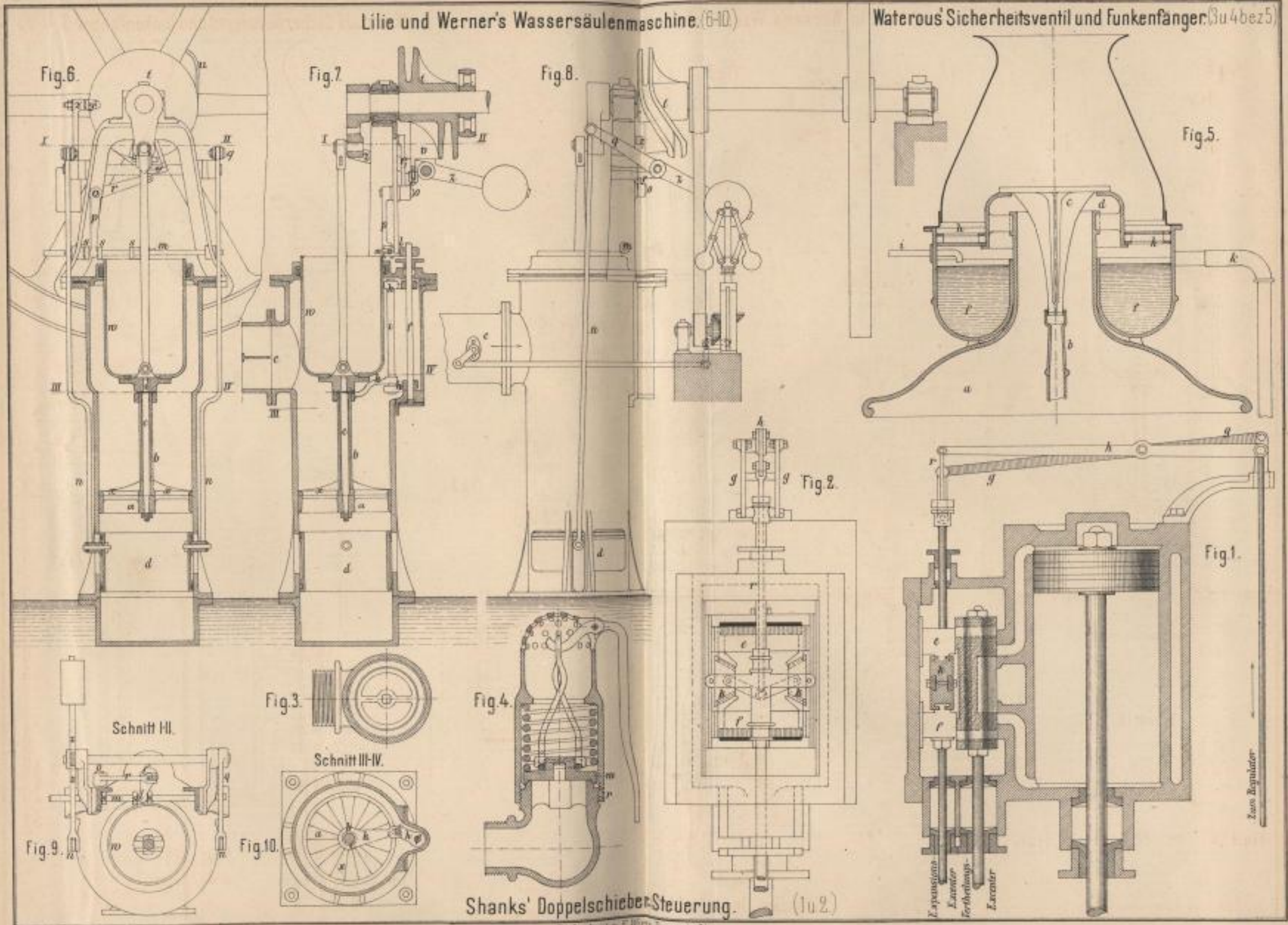

Shanks' Doppelschieber-Steuerung. (1u2.)

Pat. Anst. F. W. W. Bernstadt.

Zwei Regulator



### Kesselspeisepumpe von Chiazzari de Torres (1-5)

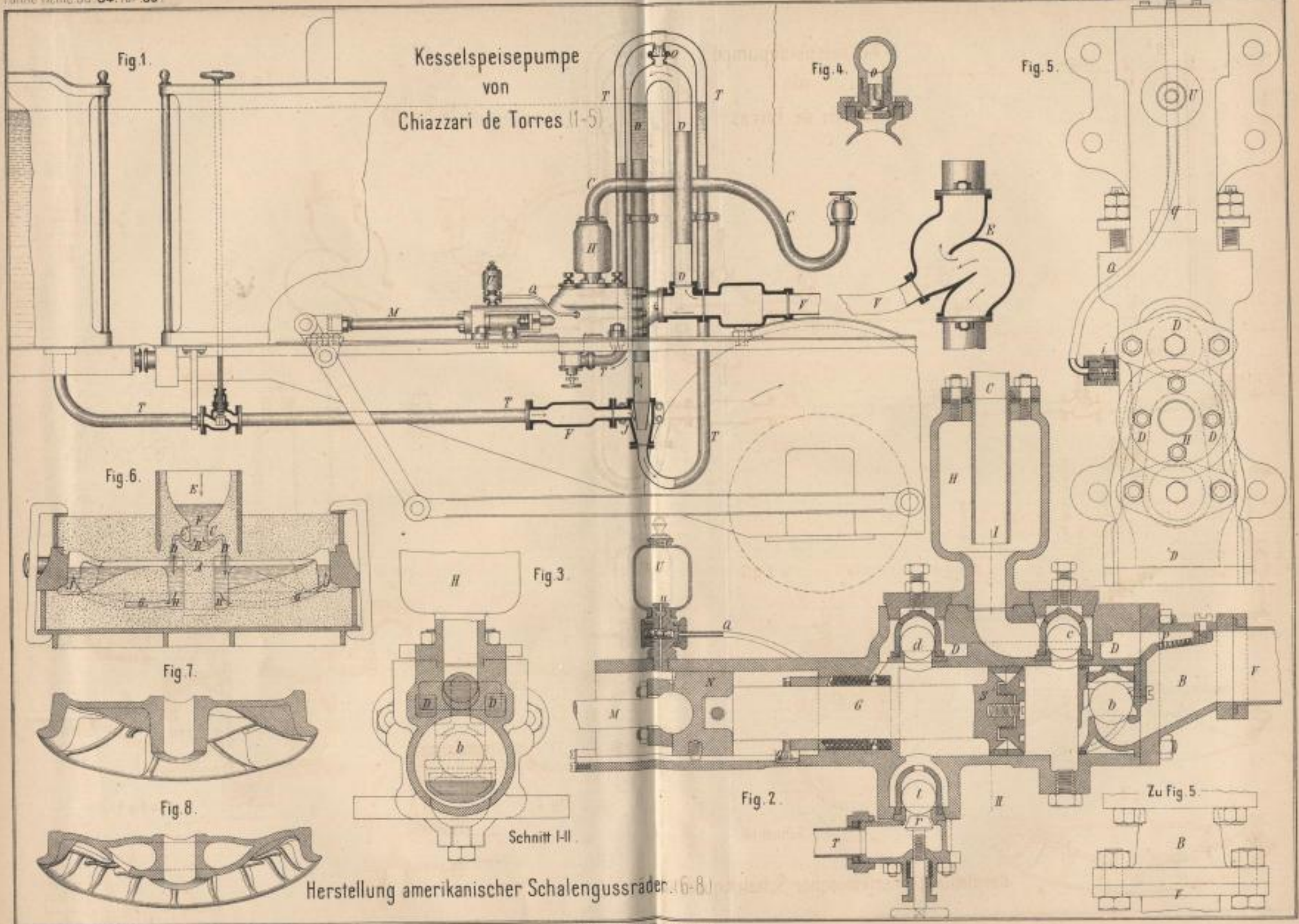

Herstellung amerikanischer Schalengussräder (6-8)

Lith. Anst. v. J. W. Neumann



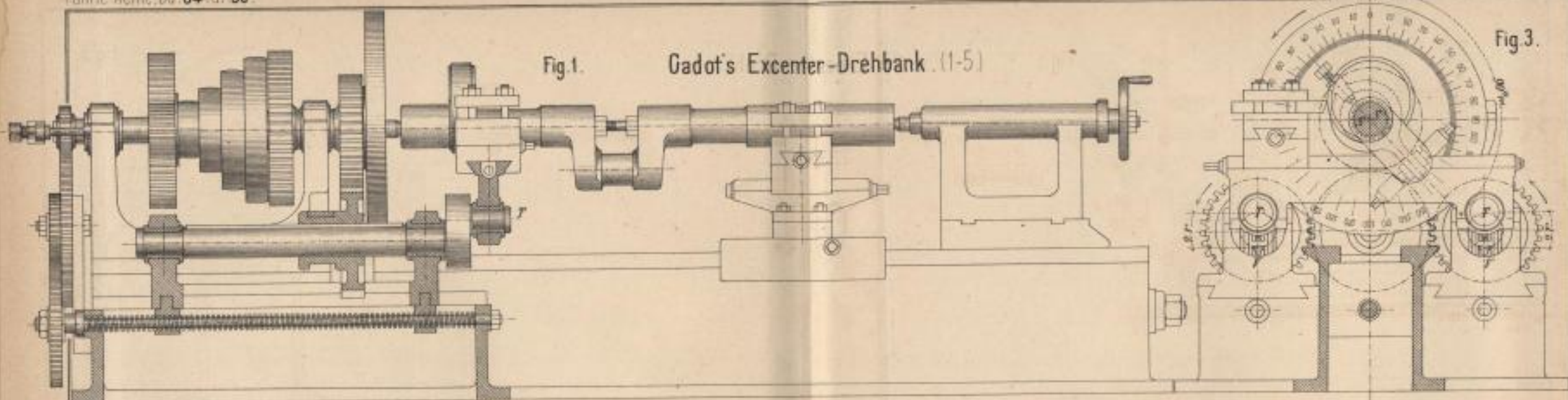

Fig. 1. Gadot's Excenter-Drehbank (1-5)

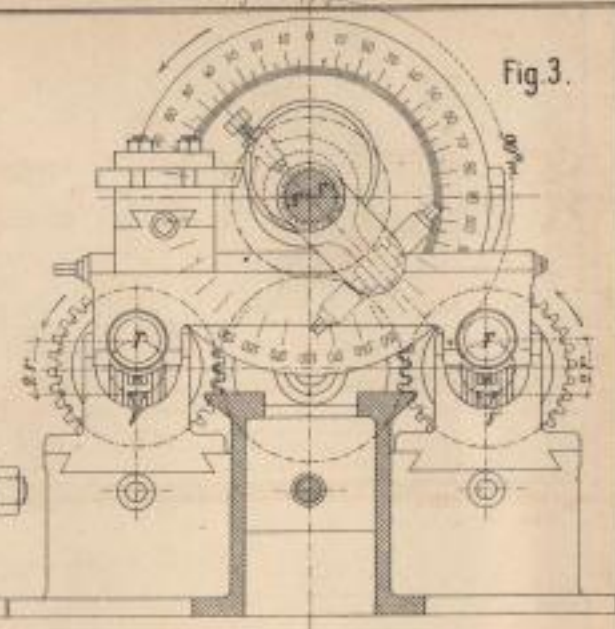

Fig. 3.

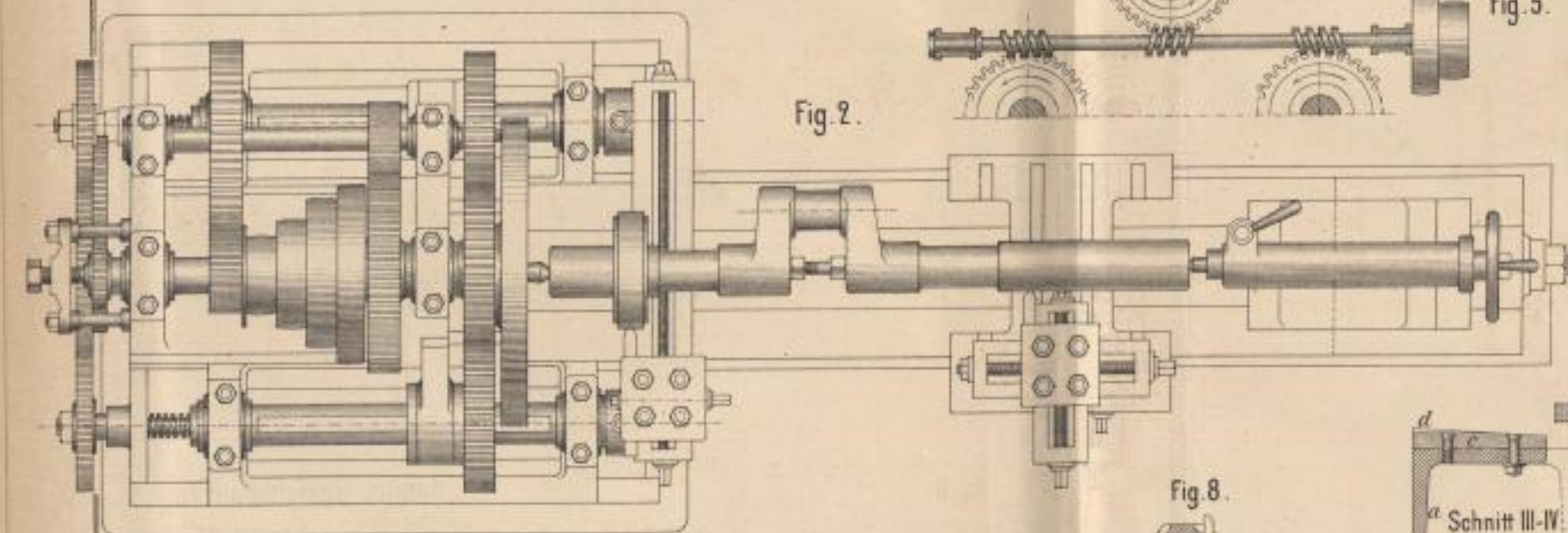

Fig. 2.

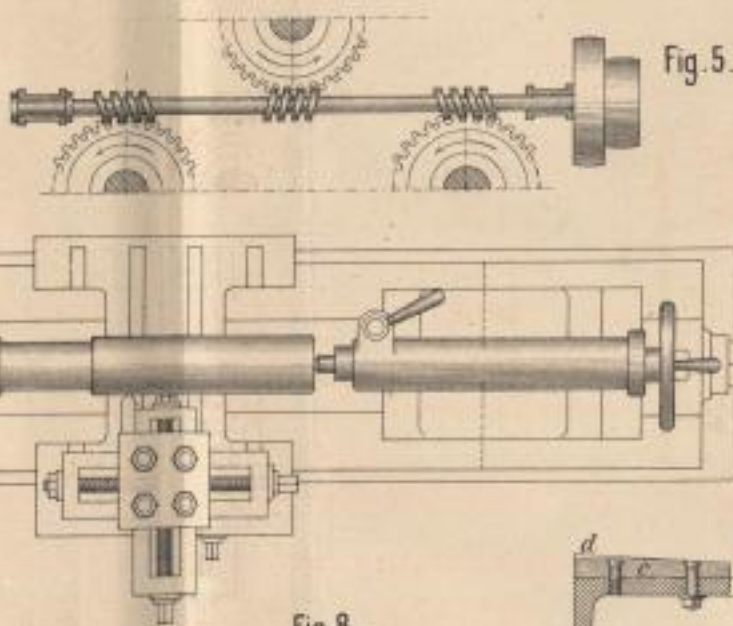

Fig. 5.

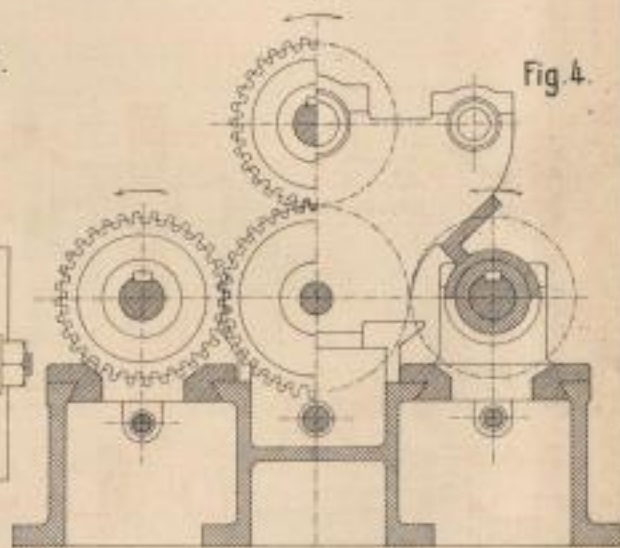

Fig. 4.

Bradshaw's Weblade (7-10)

Fig. 7.

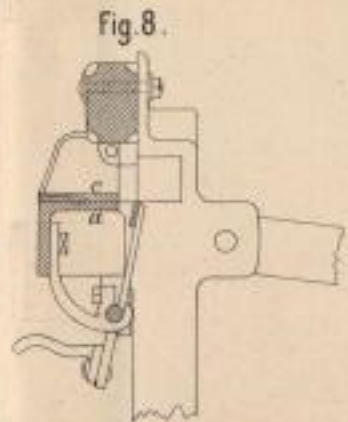
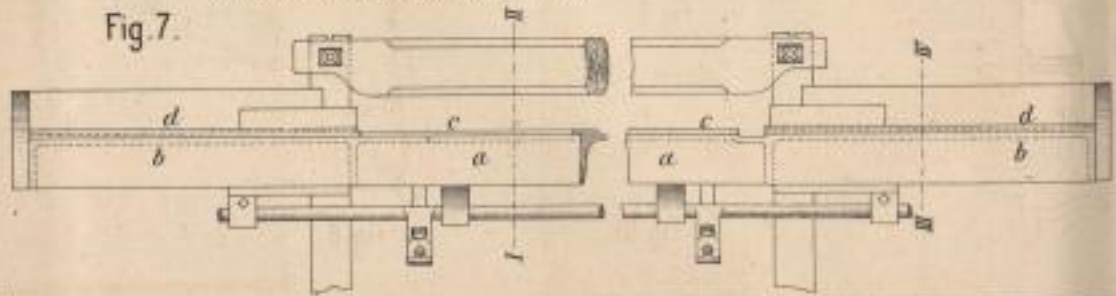

Fig. 8.



Fig. 9.

Schnitt I-II

Fig. 10.

Rabius' Speicheraufzug (6)

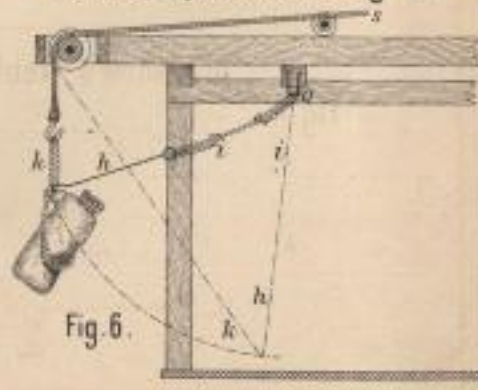
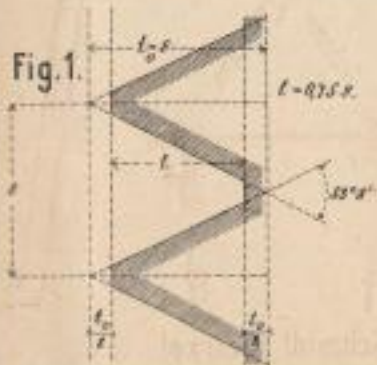
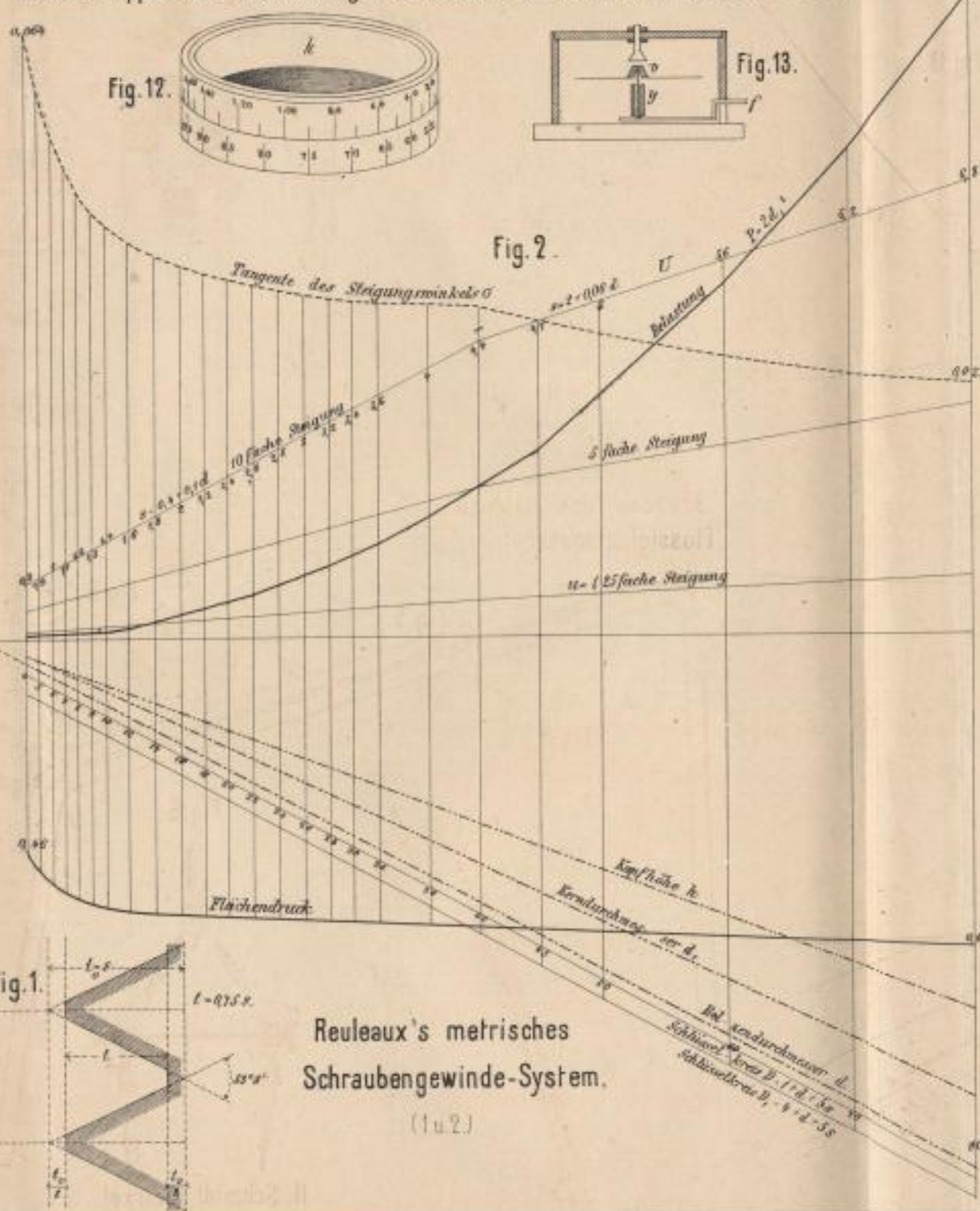

Fig. 6.

Lith. Anst. v. F. Wirtz, Darmstadt.



Nolten's Apparat zur Bestimmung des Einfallens und Streichens der Bohrlöcher. (7-15)



Reuleaux's metrisches Schraubengewinde-System. (1 u. 2.)

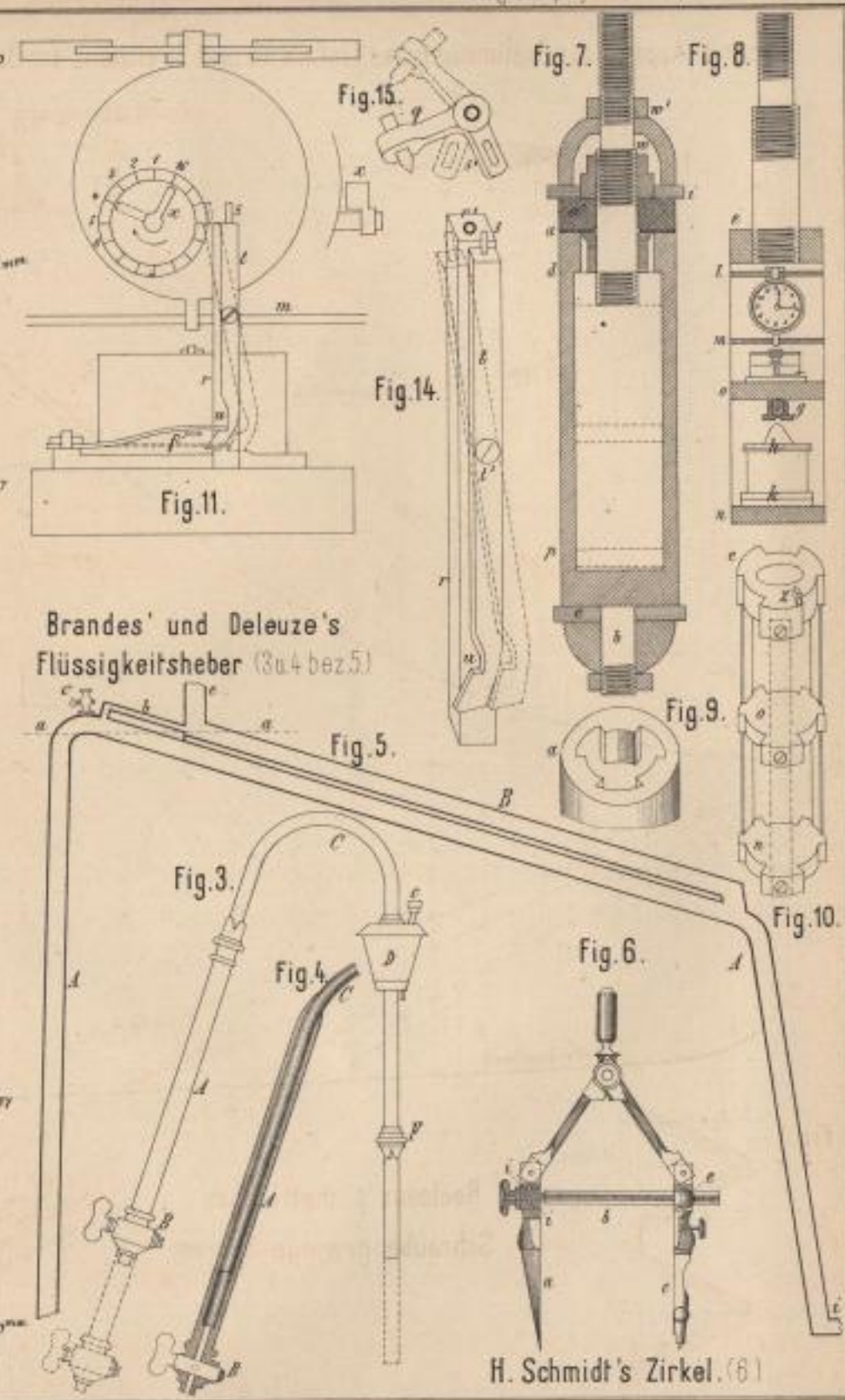

Brandes' und Deleuze's Flüssigkeitsheber (3 u. 4 bez. 5)

H. Schmidt's Zirkel. (6)

Tab. Anst. v. F. Weyl, Darmstadt.



Jones' Herstellung blasenfreier Gussblöcke. (1-5)

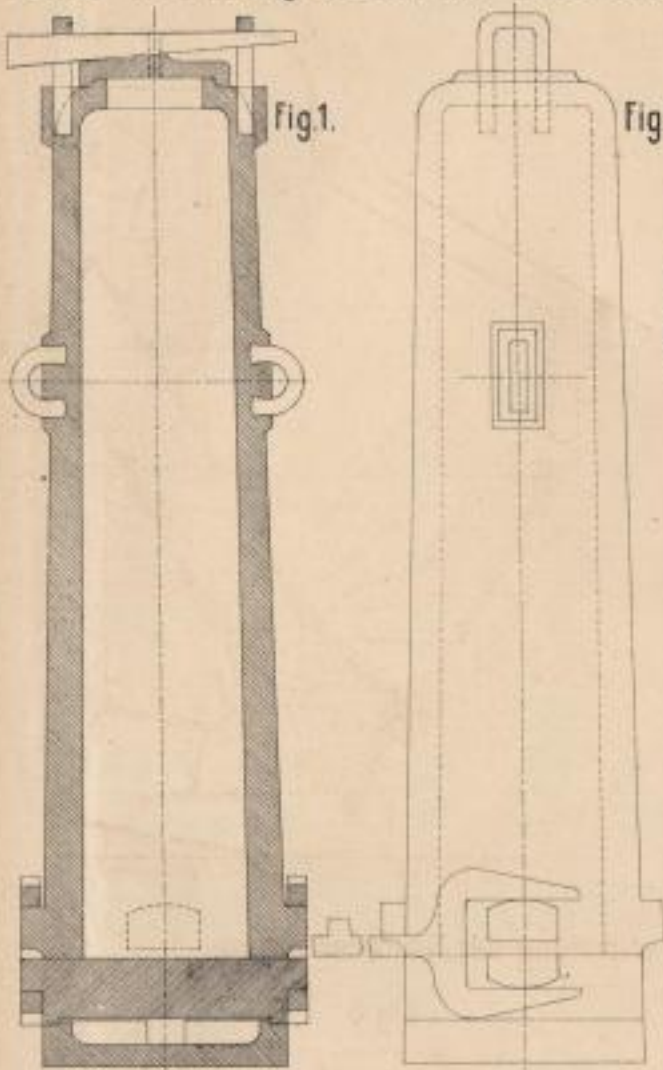

Fig. 1.

Fig. 2.

L.v. Babo's Quecksilber-Luftpumpe. (10)

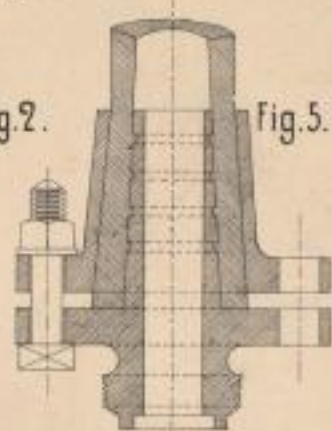

Fig. 5.

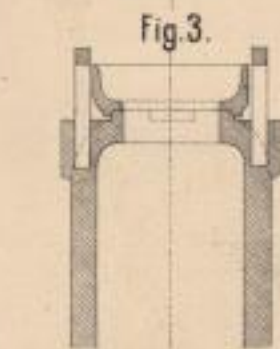

Fig. 3.

Fig. 4.

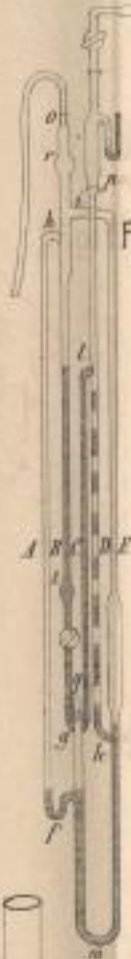

Fig. 10.

Wolpert's „Strahlenraum“-Ofen. (6-8)

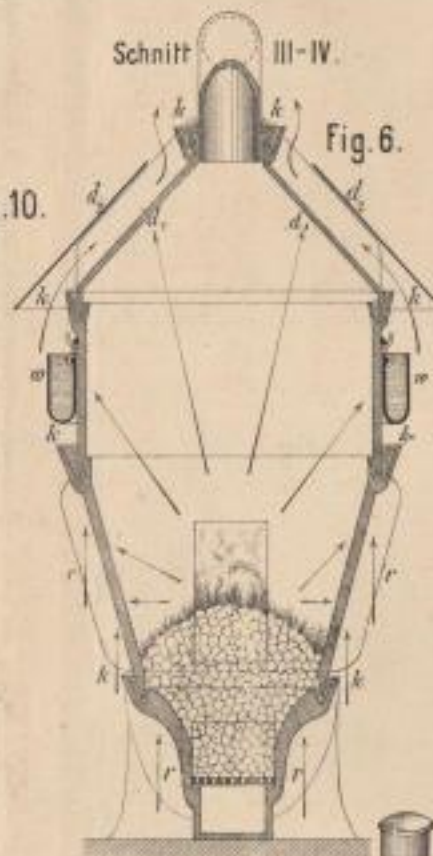

Fig. 6.

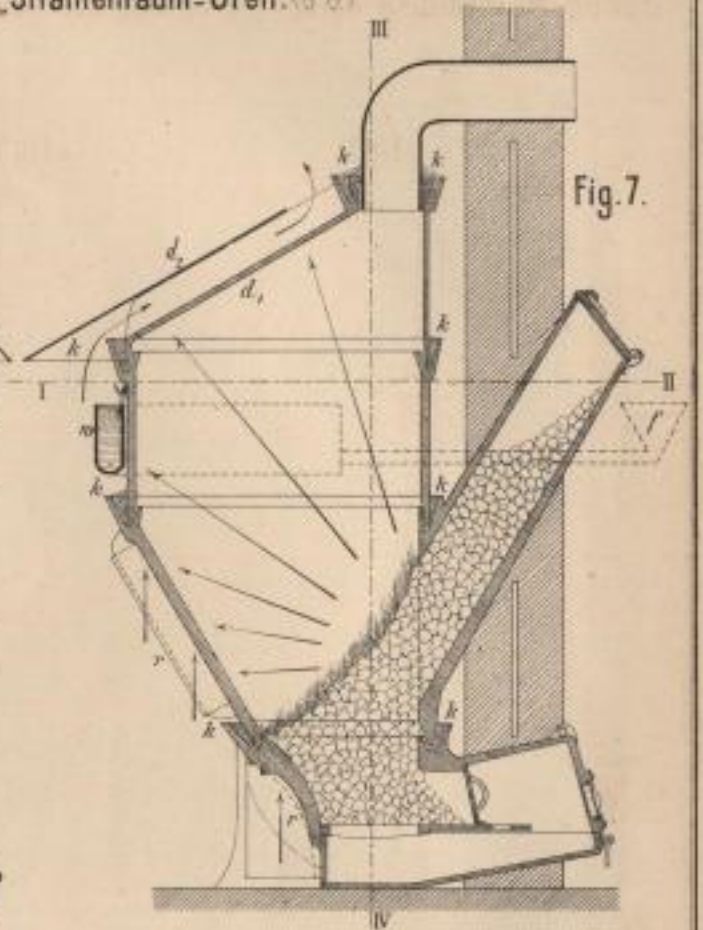

Fig. 7.

Forbes' Bestimmung der fühlbaren Wärme. (8)

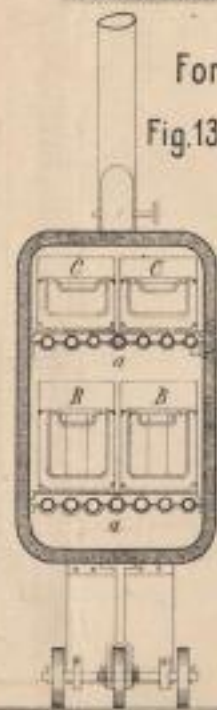

Fig. 13.



Fig. 9.

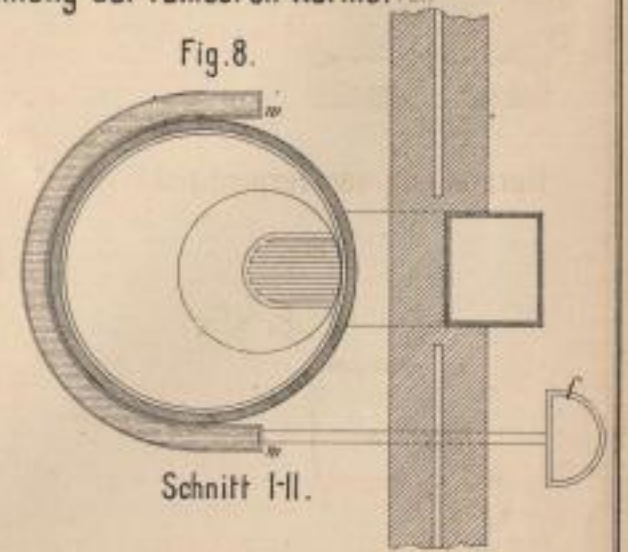

Fig. 8.

Schnitt I-II.

C. Cross' Desinfectionsapparat. (12-13)

Herstellung von Terpentinöl. (11)

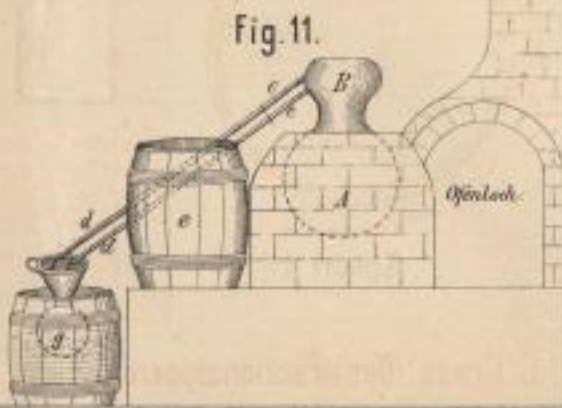

Fig. 11.

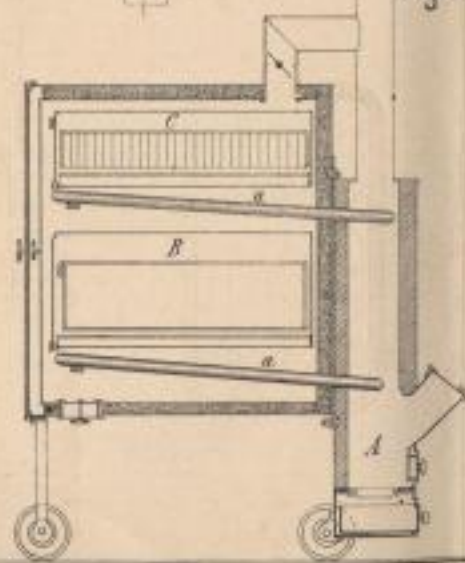

Fig. 12.

*Zeich. von P. Wron, Darmstadt*























Verzeichnis der  
Buchblätter  
1858

Technol. A. 264



SLUB DRESDEN



3 2422804

