

Brüderhaus Reutlingen. (1-3)

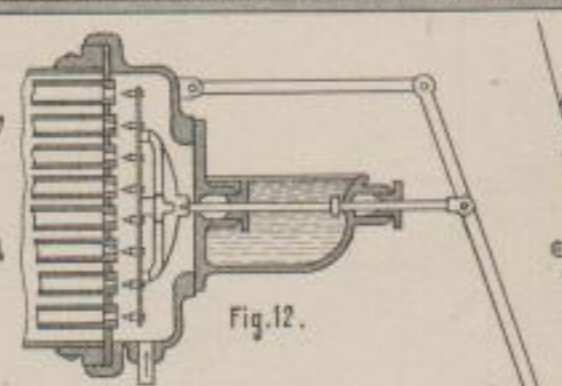

Yaryan-Verdampfapparat. (12 u. 13)

Neuerungen in der Papierfabrikation. (1-6)

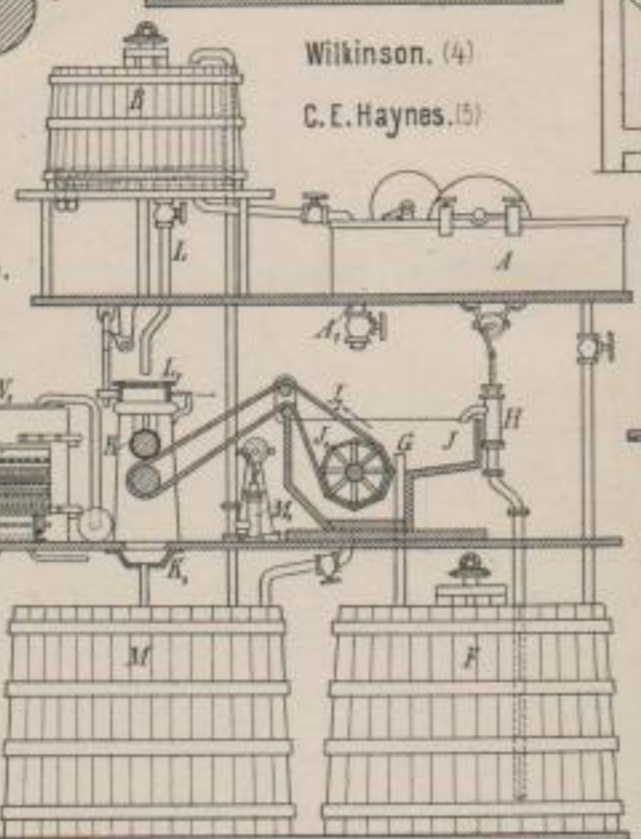
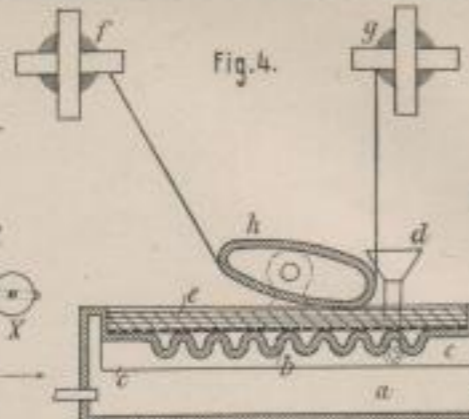
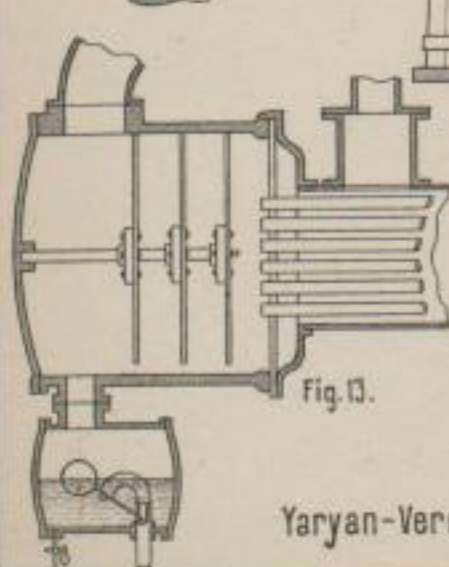
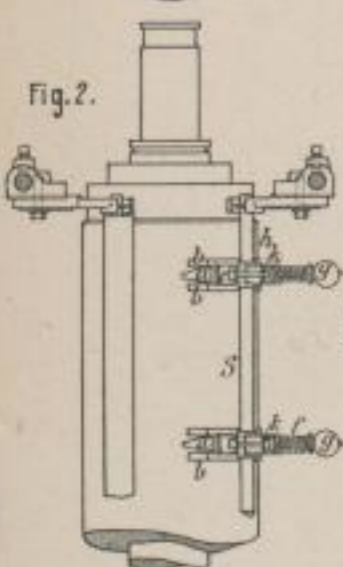
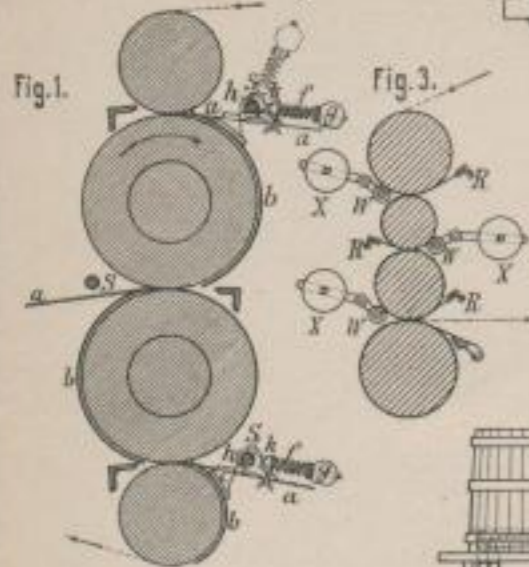
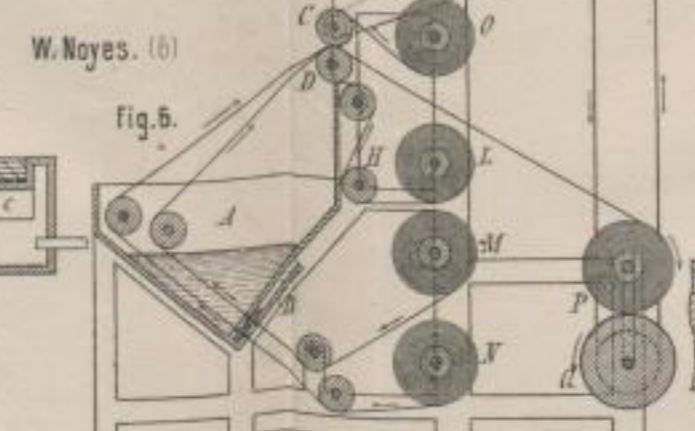

Dämpfer für Wollgespinnste, von Heilmann, Ducommun u. Steinlen. (11)

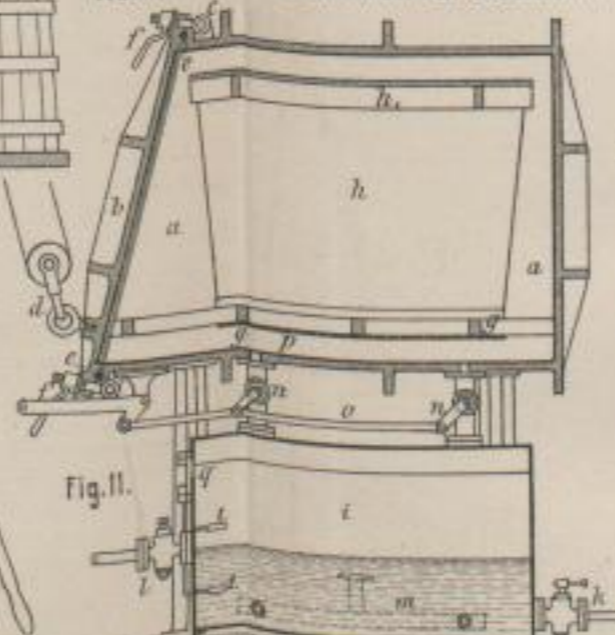

12th. Ent. v. F. Wien, Turmrad.

Carron's Girard-Turbine. (7-9)

