















Atlas

zu

Dingler's polytechnischem Journal.

Band 253.

(Fünfundsechzigster Jahrgang.)

Jahrgang 1884.

---

Enthaltend 37 lithographirte Tafeln.



Stuttgart.

Verlag der J. G. COTTA'schen Buchhandlung.

09245



Faint, illegible text, possibly bleed-through from the reverse side of the page.

Sächsische  
Landesbibliothek  
Dresden





Sächs.  
Landes-  
Bibl



Neuerungen an rotirenden Maschinen. (Taf. 1u.5)

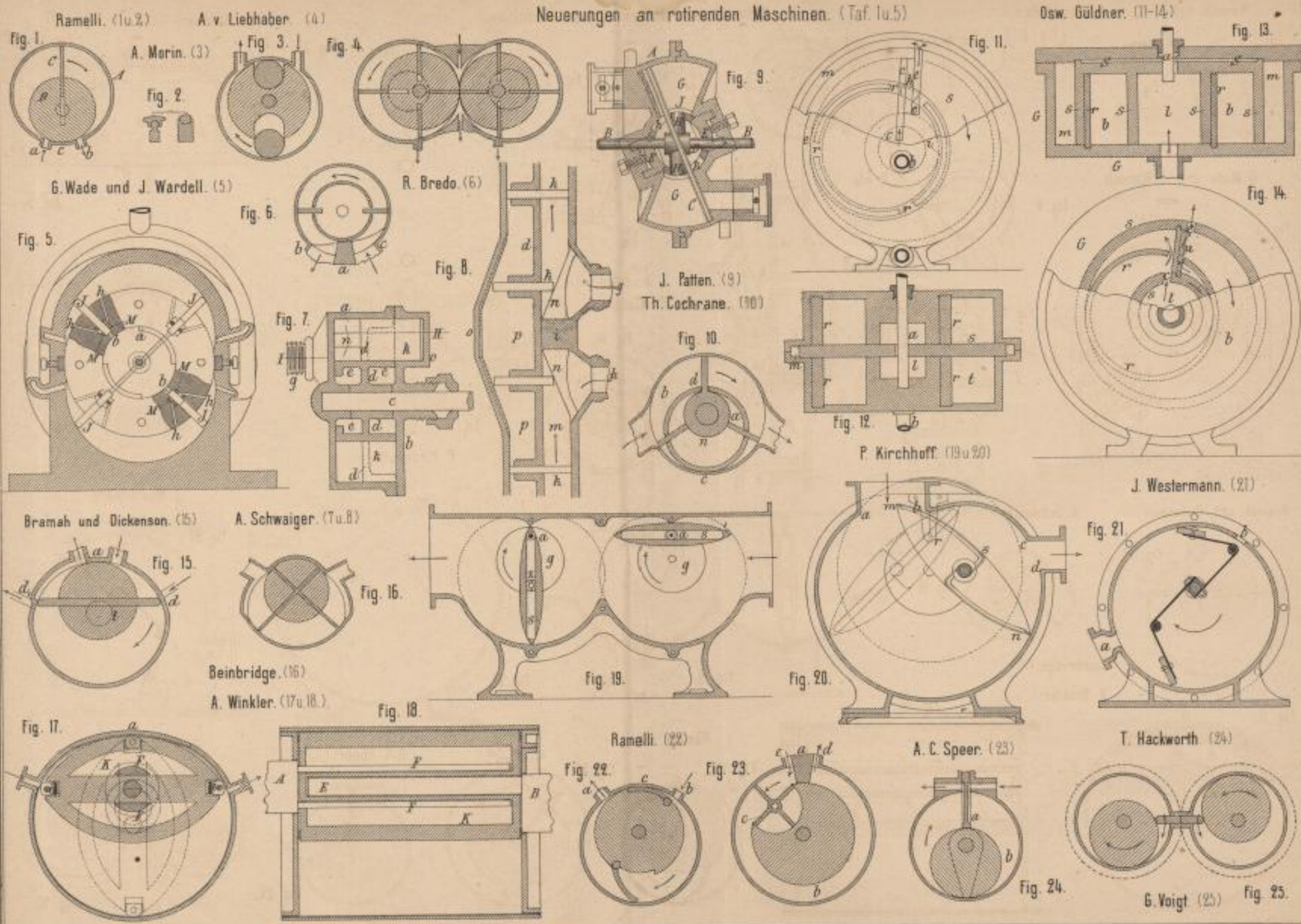

Lith. Anst. v. F. Wrlin, Darmstadt.



C. Kritzer's Maillons-Stanzmaschine. (6u7)

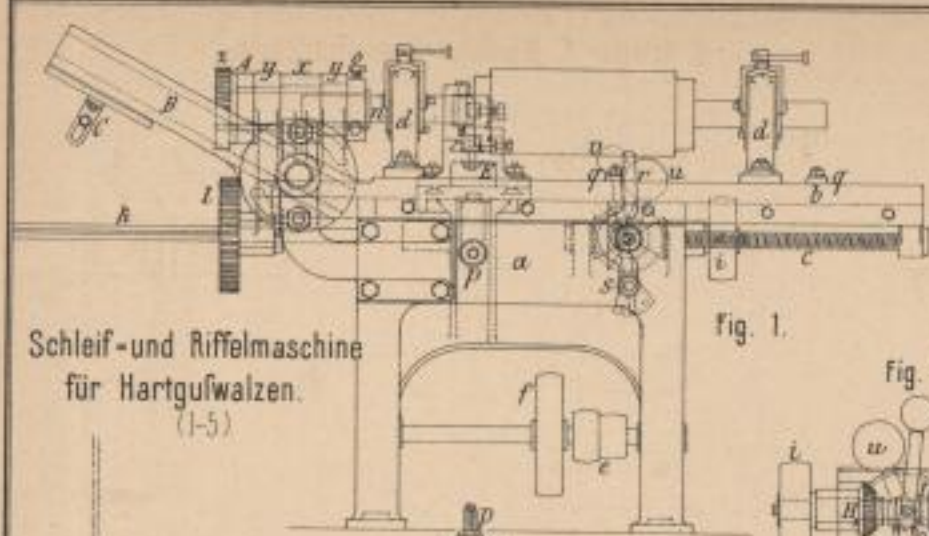

Schleif- und Riffelmaschine für Hartgufwalzen. (1-5)

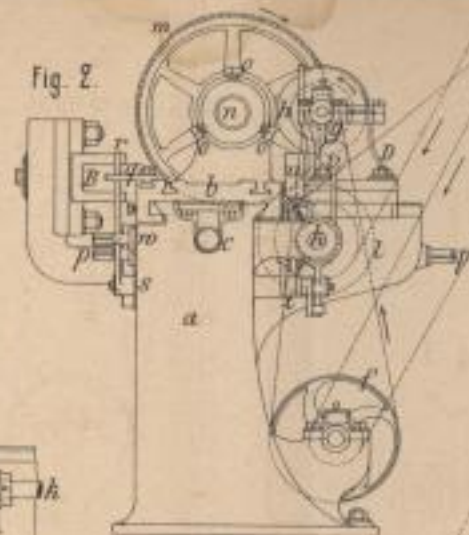

Fig. 2.

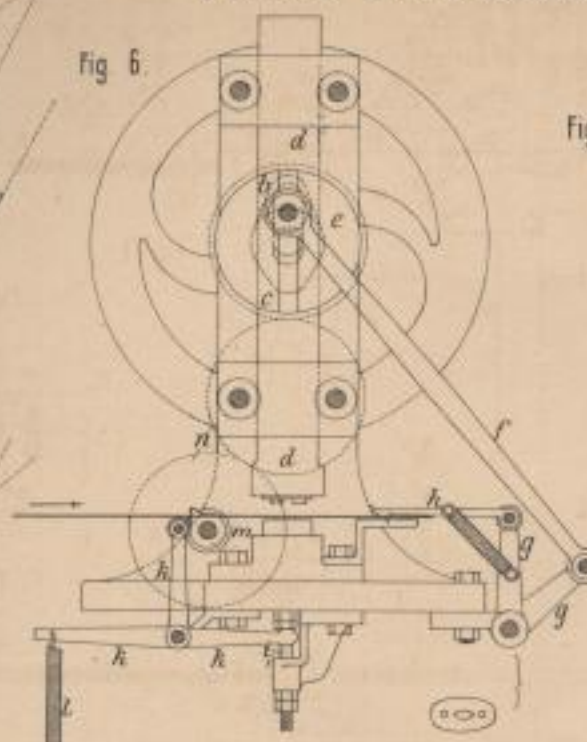

Fig. 6.

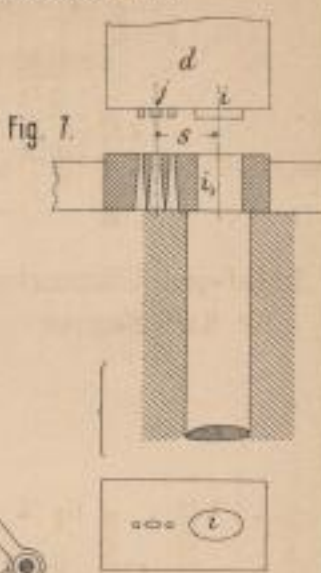

Fig. 7.

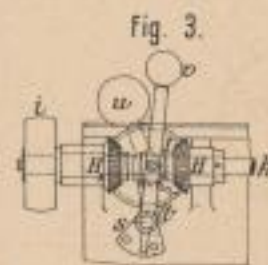

Fig. 3.

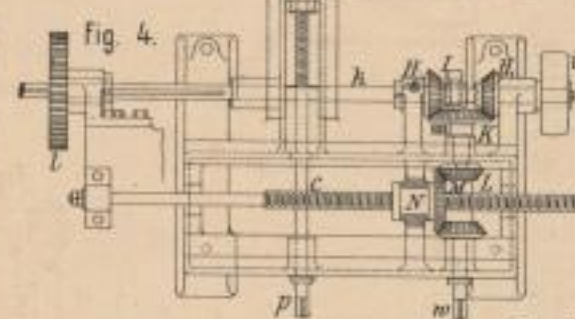

Fig. 4.

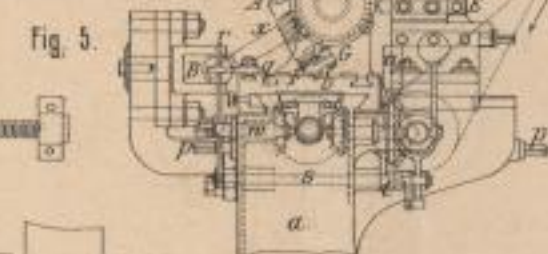

Fig. 5.

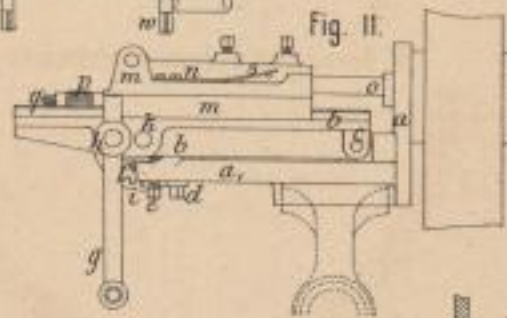

Fig. 11.

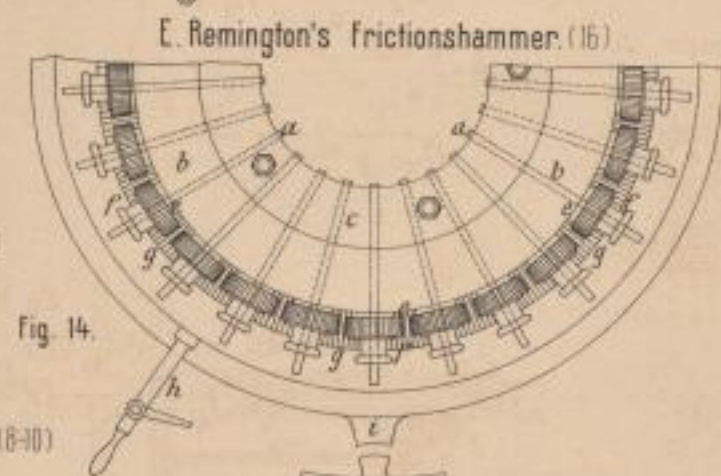

Fig. 14.

E. Remington's frictionshammer. (15)

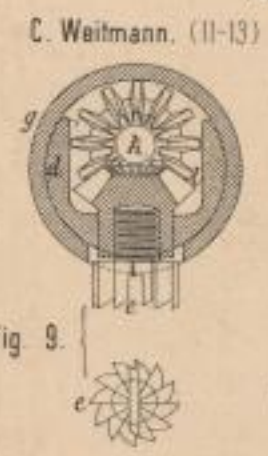

Fig. 9.

C. Weitmann. (11-13)

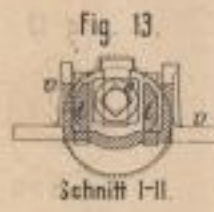

Fig. 13.

Schnitt I-II.

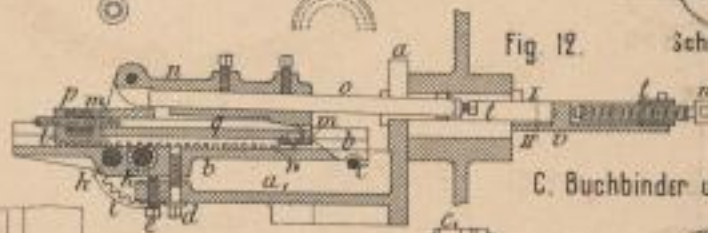

Fig. 12.

C. Buchbinder und L. Vogt. (8-10)

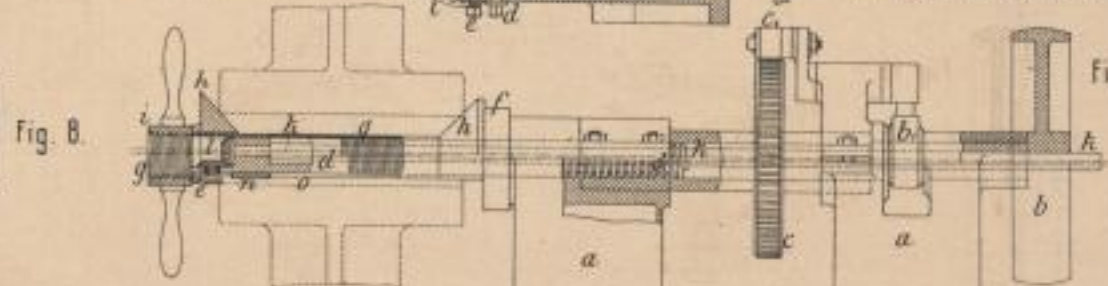

Fig. 8.

Herstellung von Keilnuthen. (8-10 bez 11-13)

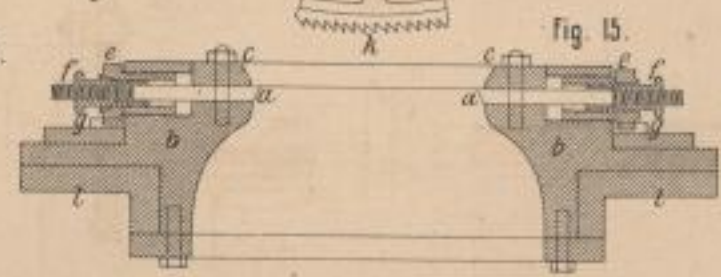

Fig. 15.

Philippot, Schneider und Jaquet's Riffelapparat. (14u 15)

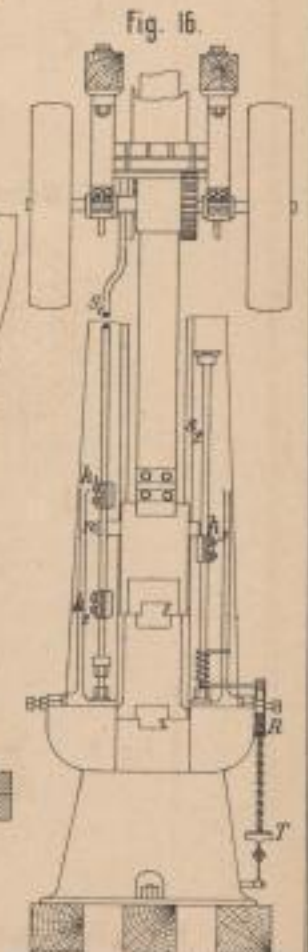

Fig. 16.

Lith. Anst. v. F. Wörck, Darmstadt.





Neuerungen in der Herstellung von Papierstoff. (Taf. 3)

Fr. Henseling. (1-2)

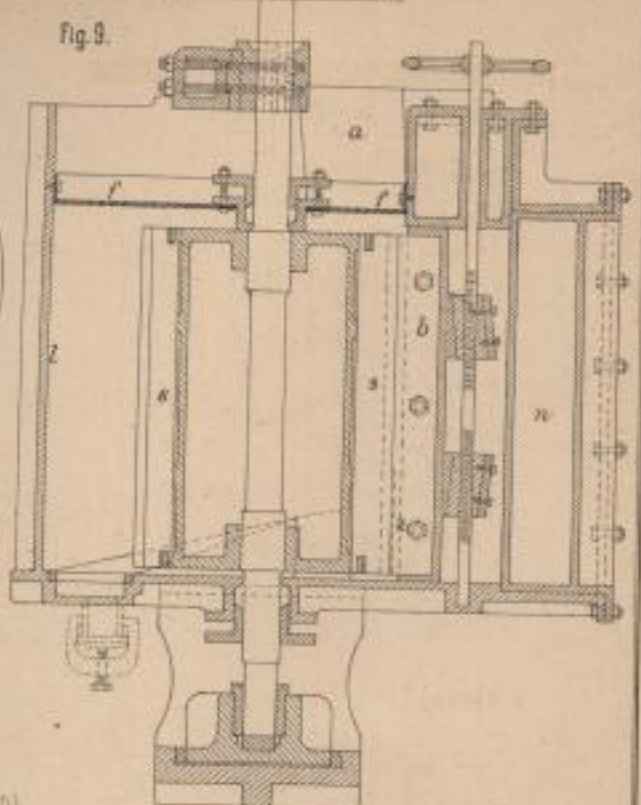
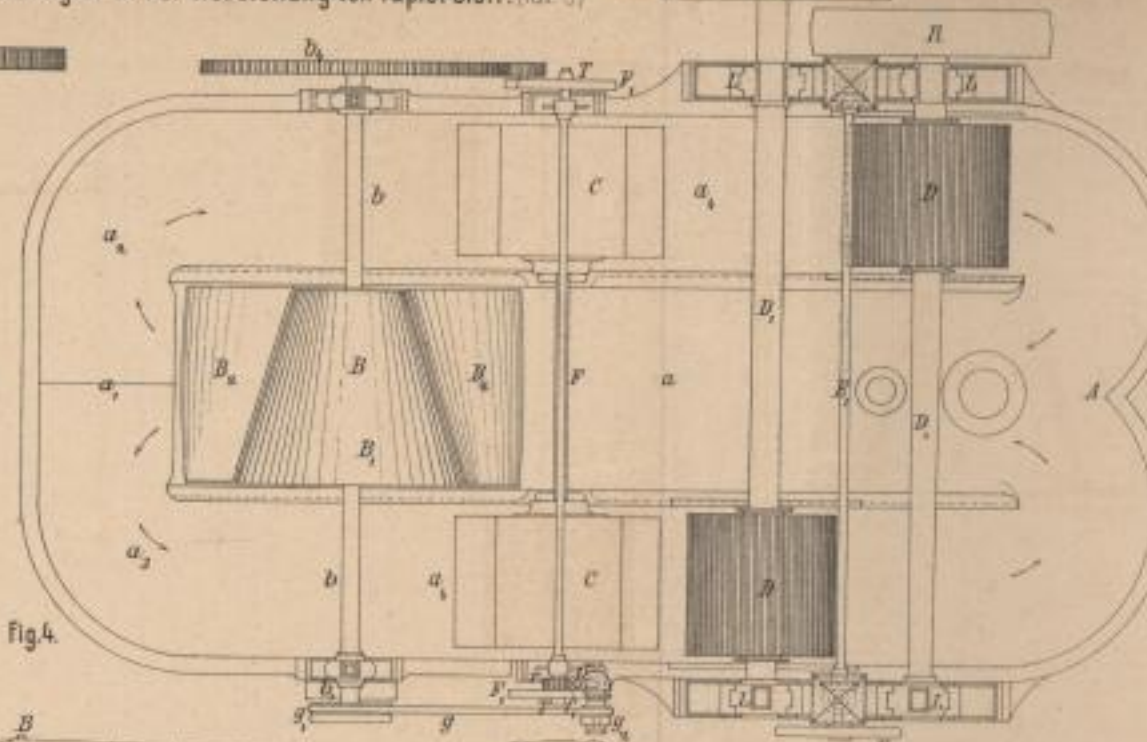
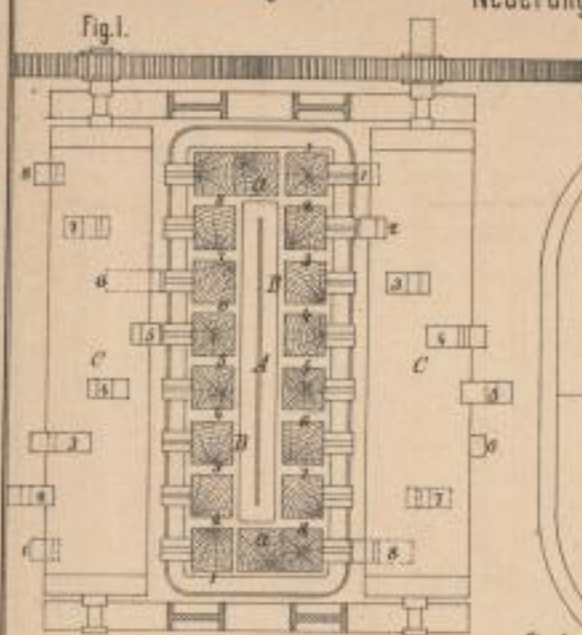

A. Hankey. (3)

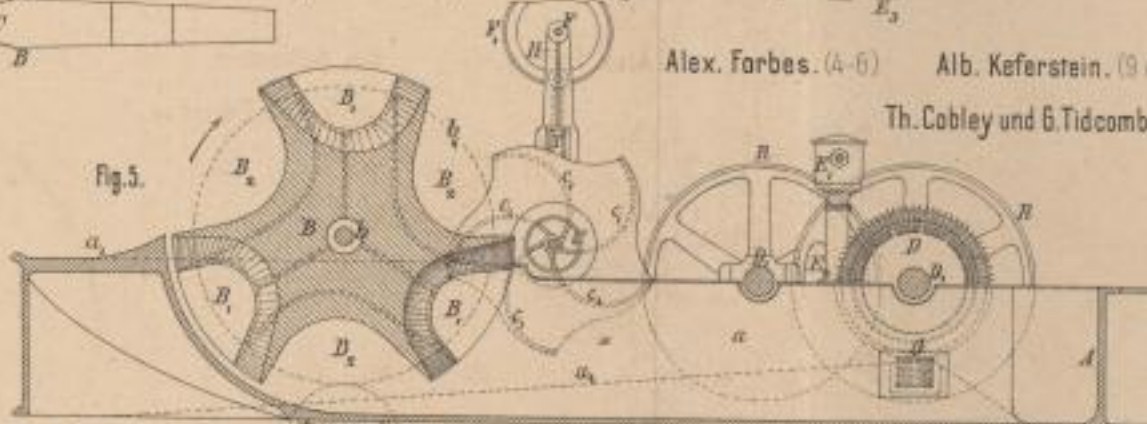
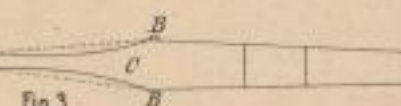
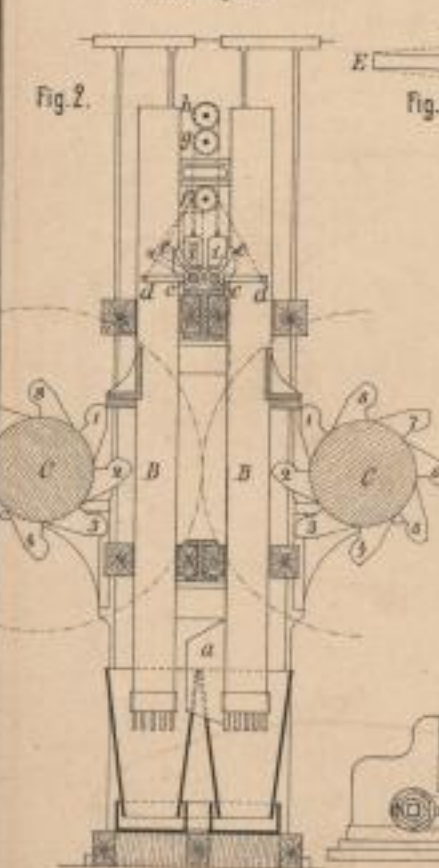

Alex. Forbes. (4-6) Alb. Keferstein. (9 u. 10)  
Th. Cobley und G. Tidcombe. (11)

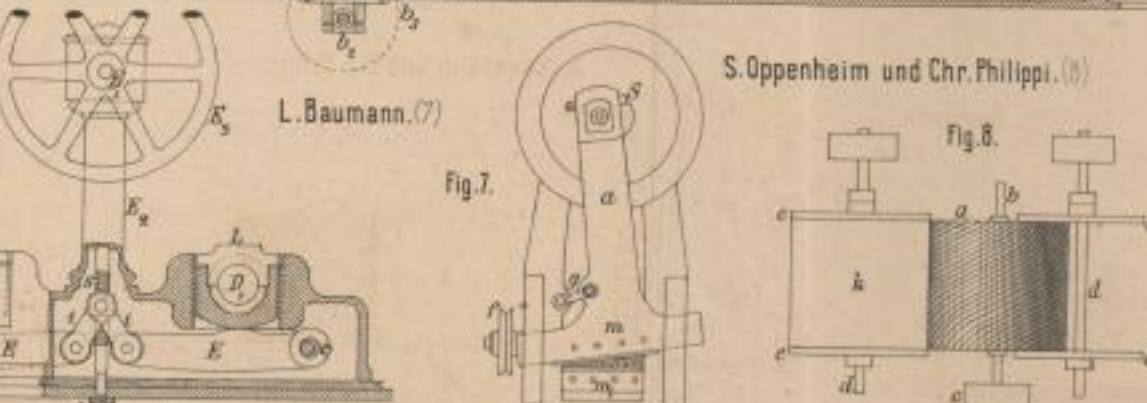

L. Baumann. (7)

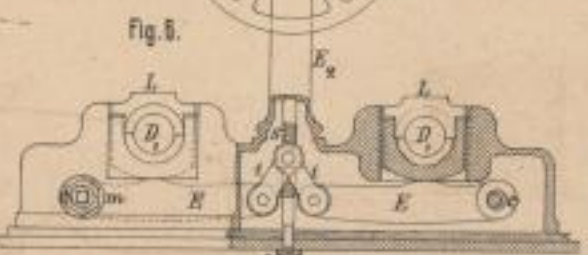

S. Oppenheim und Chr. Philippi. (8)

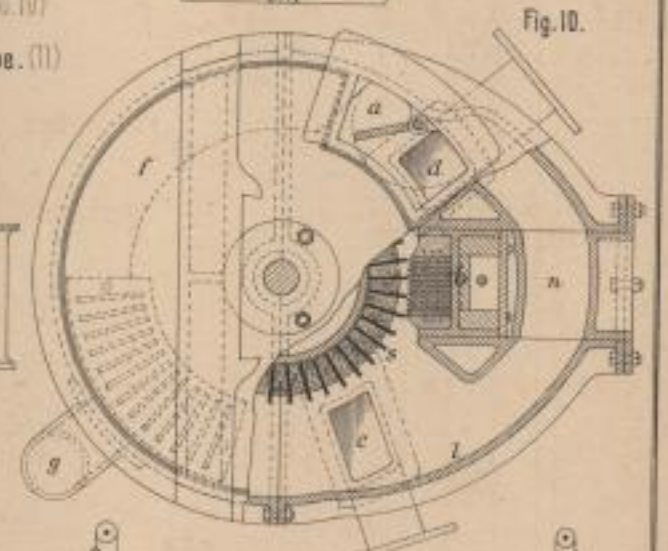
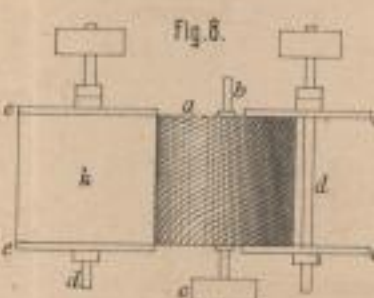

Lith. Anst. v. F. W. B. Darmstadt



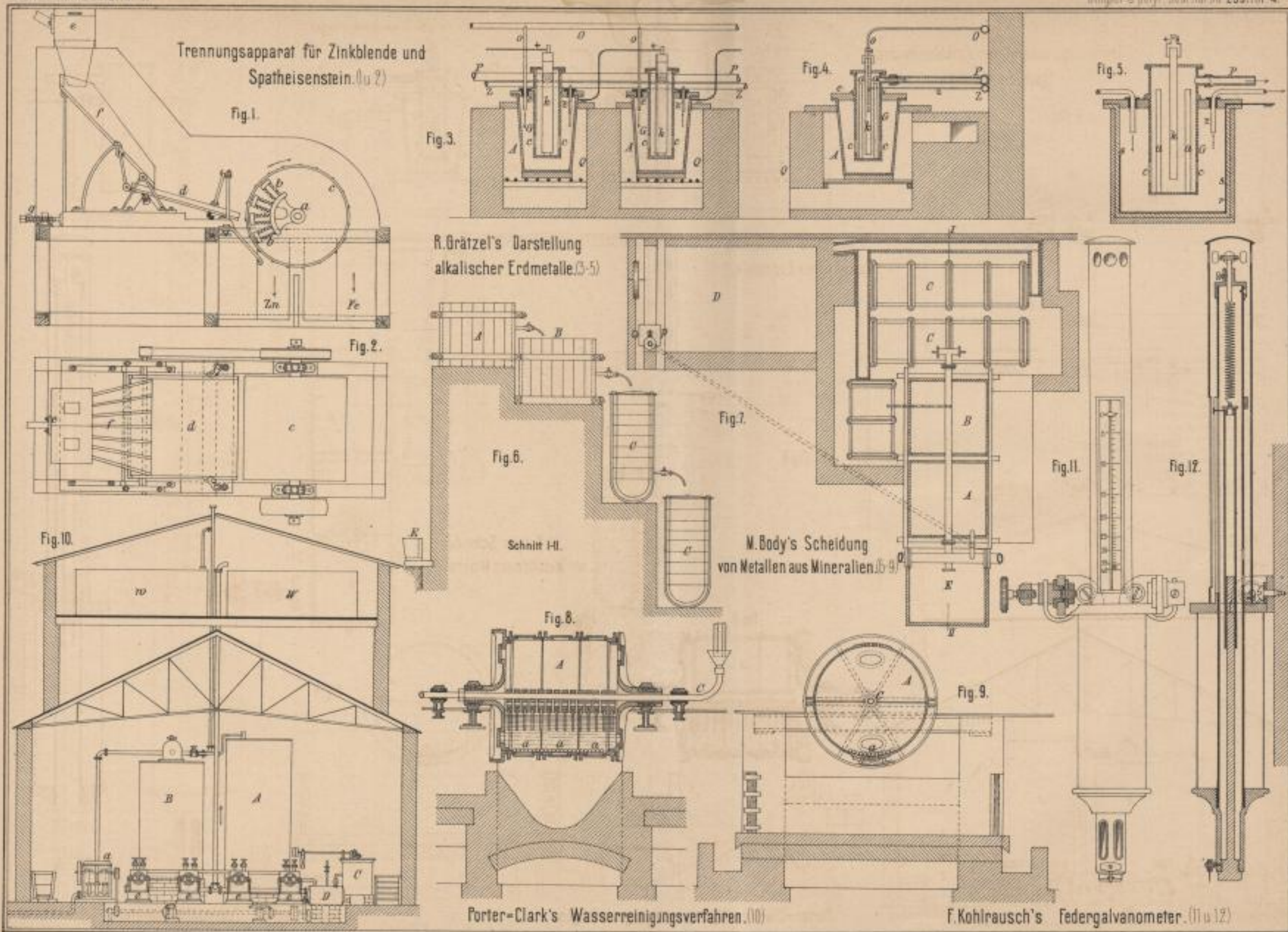

Lith. Anst. v. F. Wiese, Darmstadt.



Neuerungen an rotirenden Maschinen. (Taf. 1 u. 5)

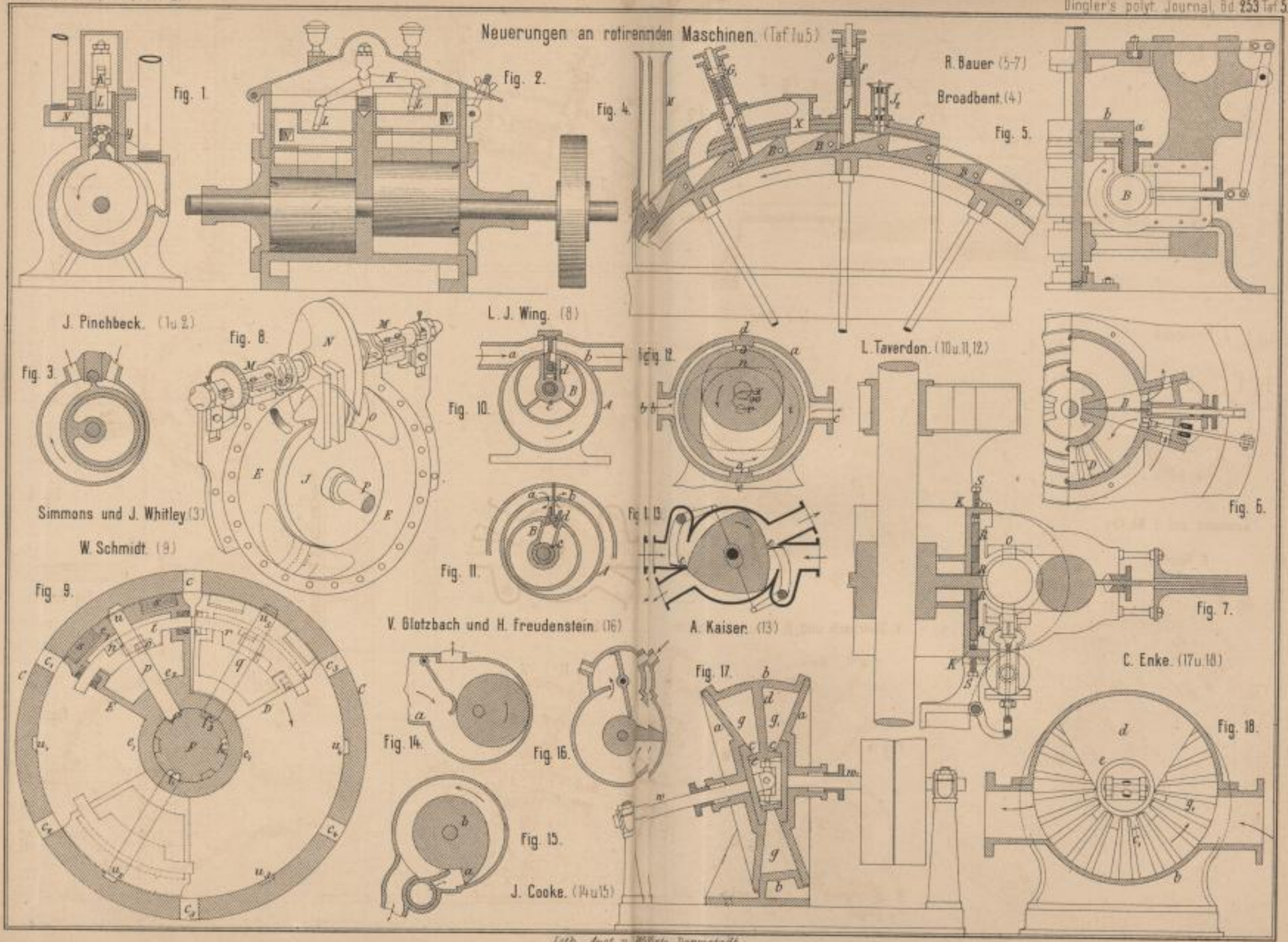

Lith. Anst. v. Wörts, Darmstadt.



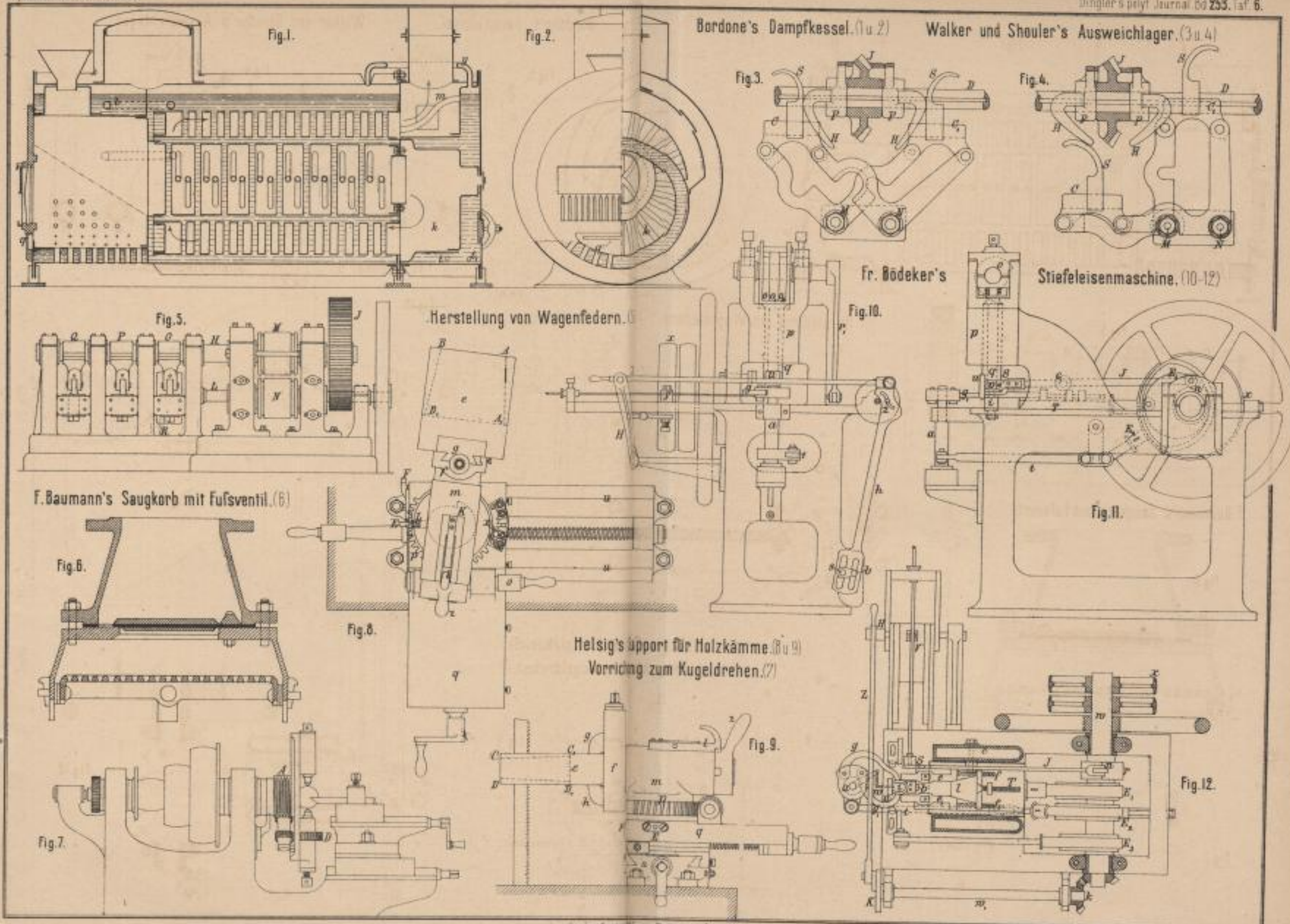

Zich. And. Witt. Darmstadt.



E. Schott's bez. L. Leseigneur's Kalkbrennofen. (1-4)

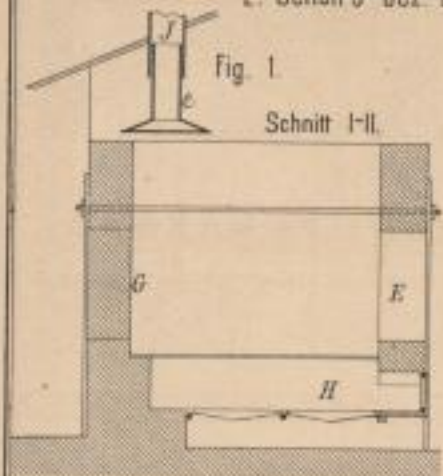

Fig. 1

Schnitt I-II.

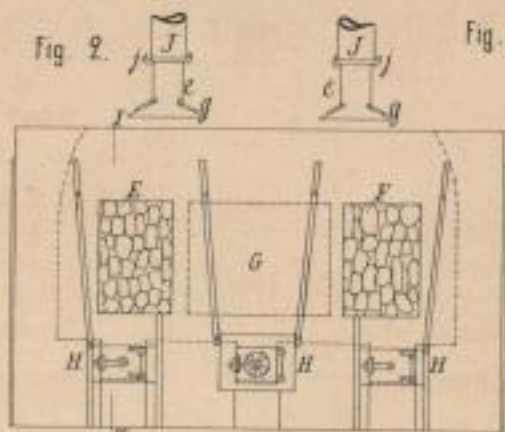
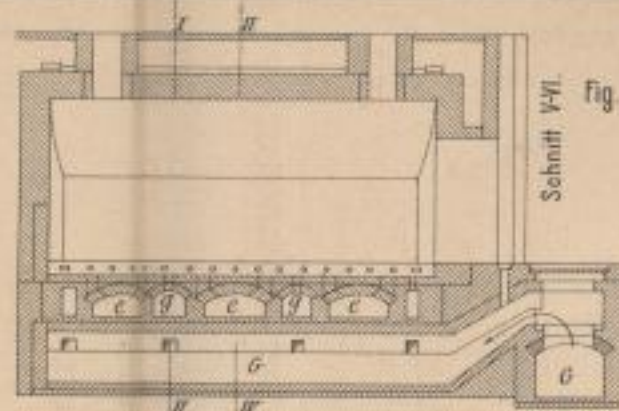

Fig. 2

Fig. 7



Schnitt V-VI.

Fig. 8

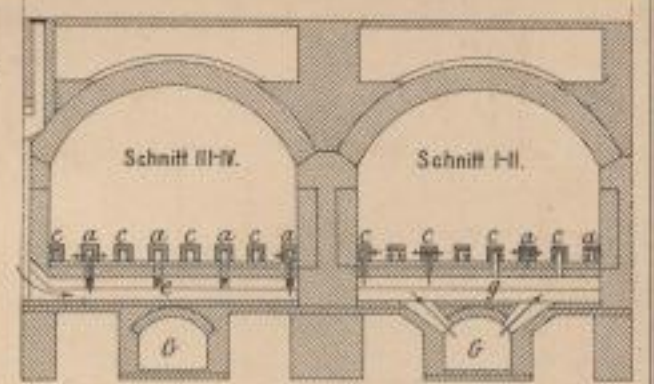

Schnitt III-IV.

Schnitt I-II.

Herstellung von Strontian. (5-9)

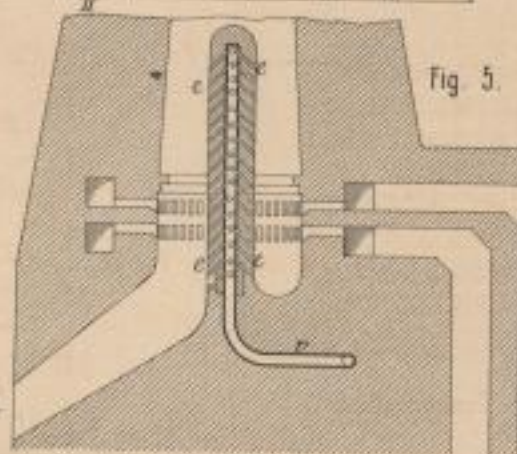

Fig. 5

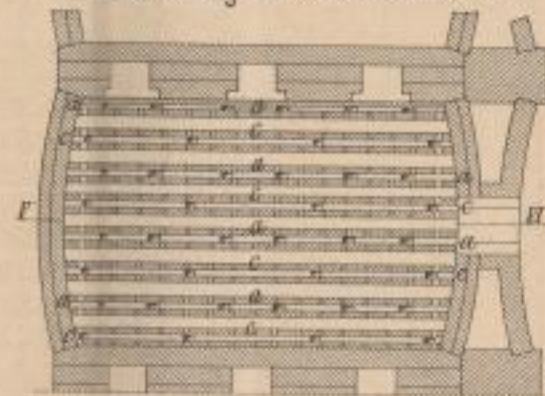

Fig. 9

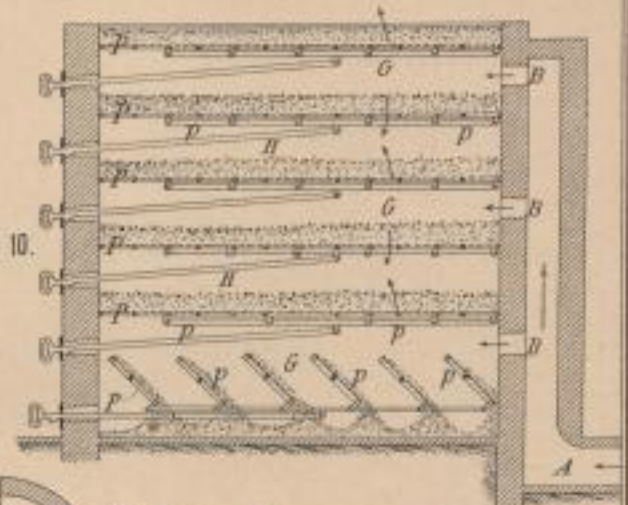

Fig. 10

R. Ziamezynski. (5u6)

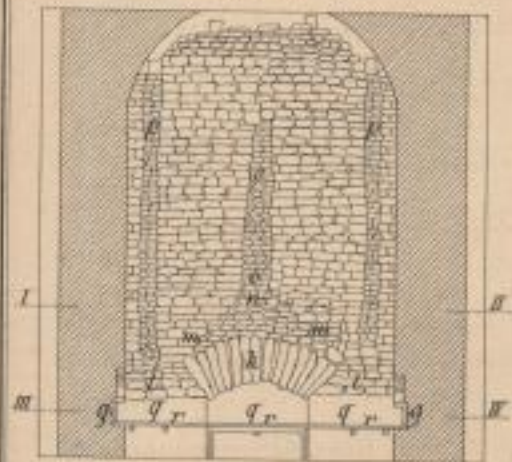

Fig. 3

Schnitt I-II.

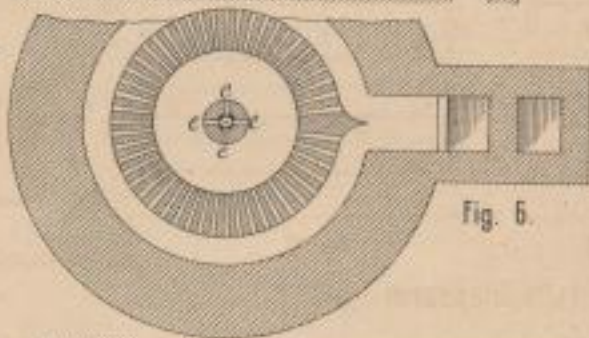

Fig. 6

Dessauer Actien-Zuckerraffinerie. (7-9)



Fig. 11

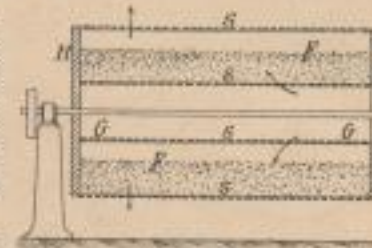

Fig. 12

Boltri's Getreidetrockenapparate. (10-12)



Linde's Luftkühlapparat. (13-15)

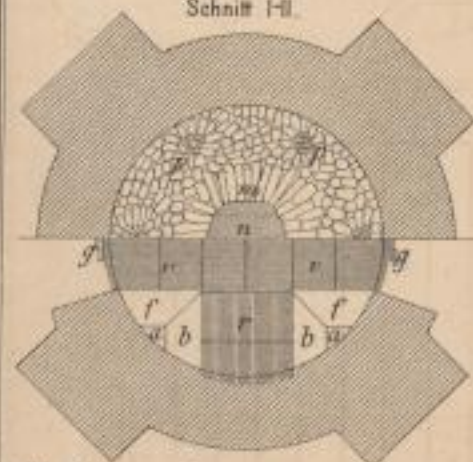

Fig. 4

Schnitt III-IV.

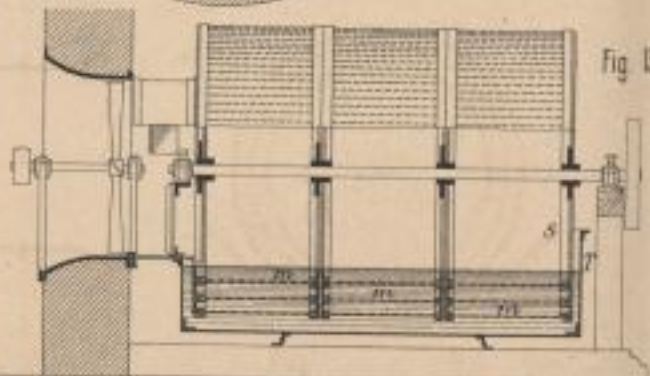

Fig. 13

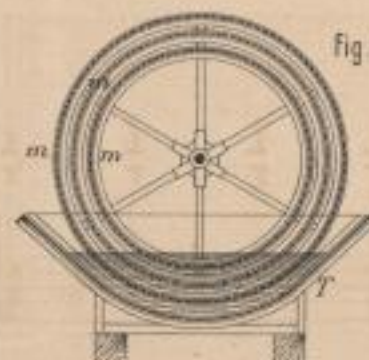

Fig. 14

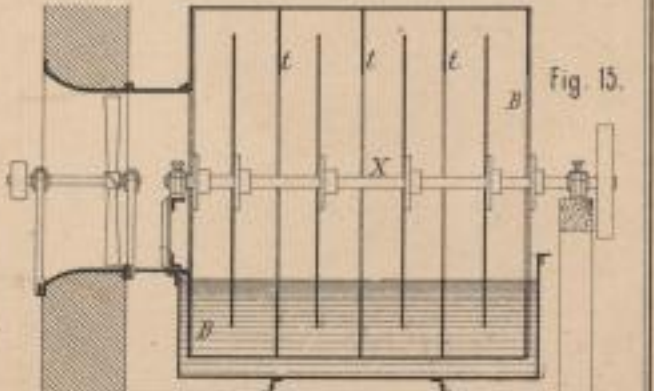
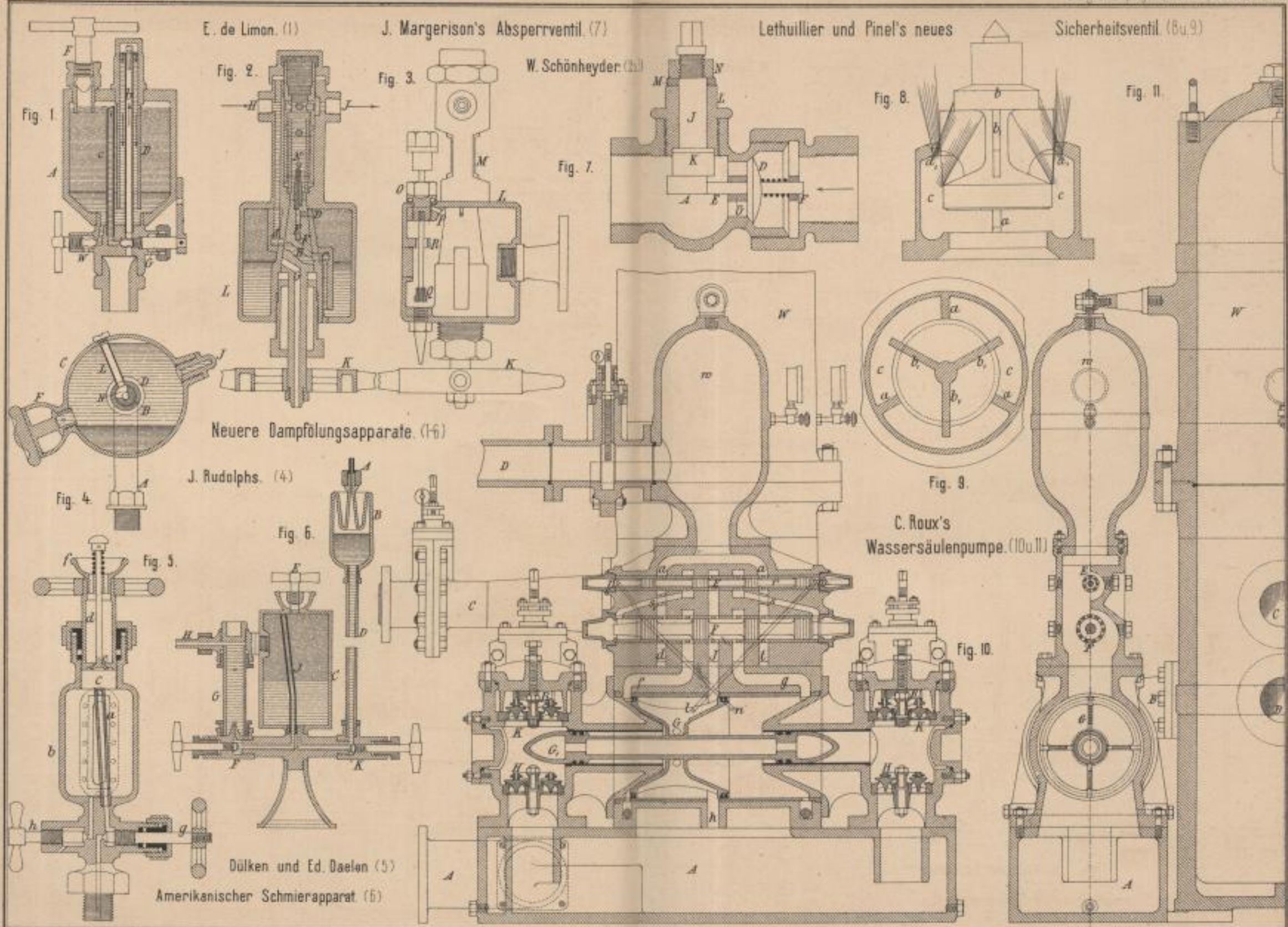

Fig. 15

Lith. Anst. v. J. Wirts, Darmstadt.





Lith. Anst. P. Wirtz, Darmstadt.



R. James' Prägemaschine (1) Walker's Schlagmühle. (2)

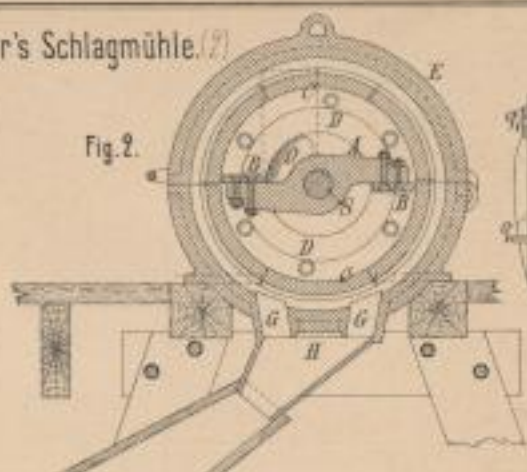
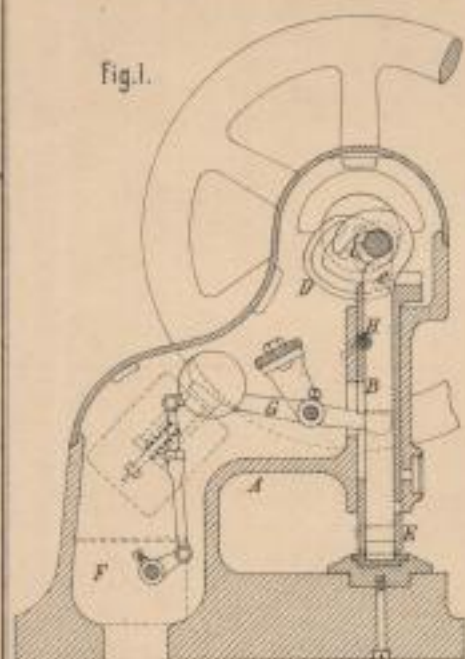

Colby's Drahtseil-Spinnmaschine. (3-5)

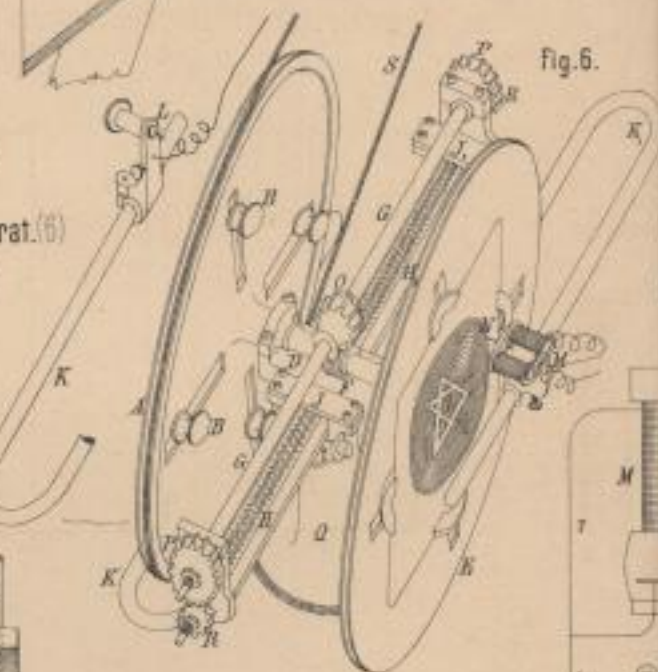
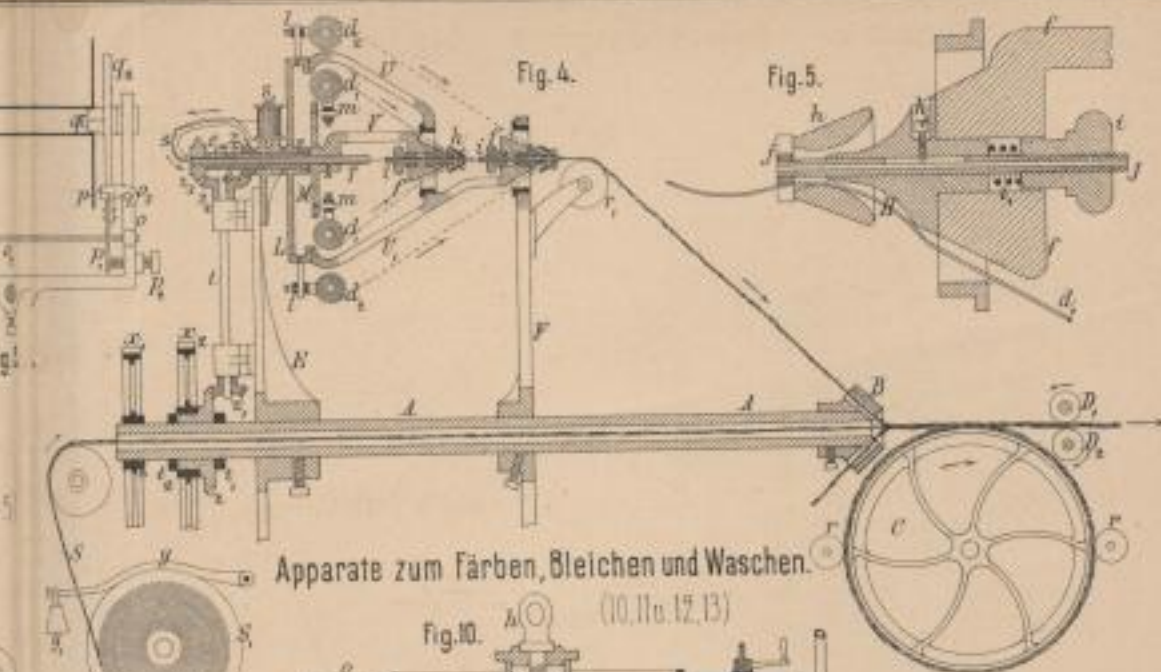
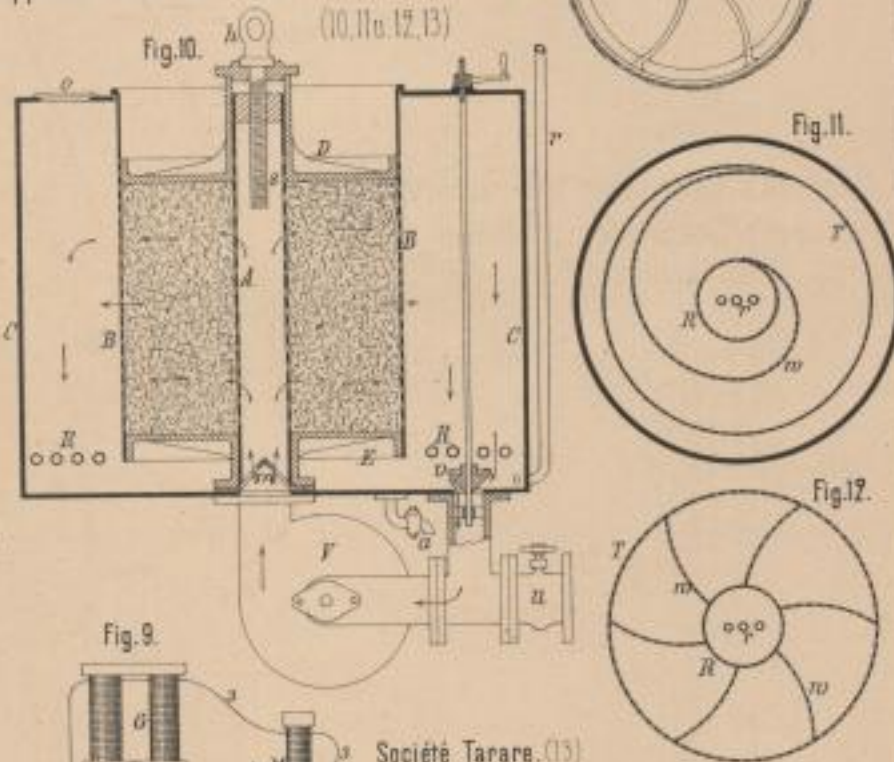

Fig. 6.



Apparate zum Färben, Bleichen und Waschen. (10, 11, 12, 13)



A. Schmid's elektrischer Gravinapparat. (6)  
Stumpf's Einrichtung zum Heben  
von Facalien. (7)

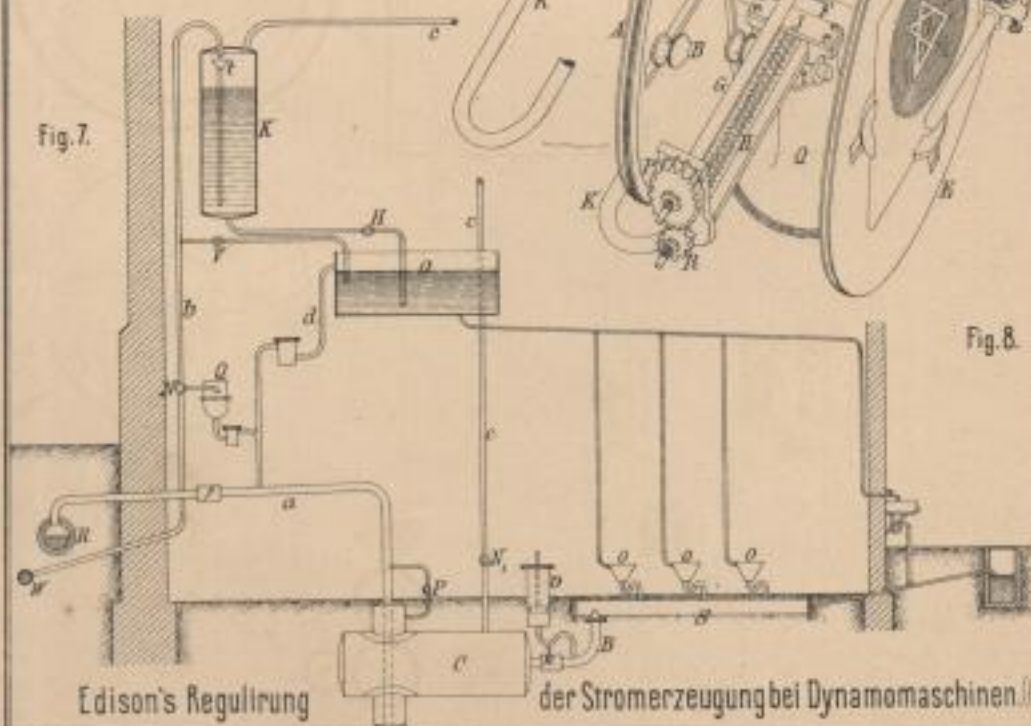
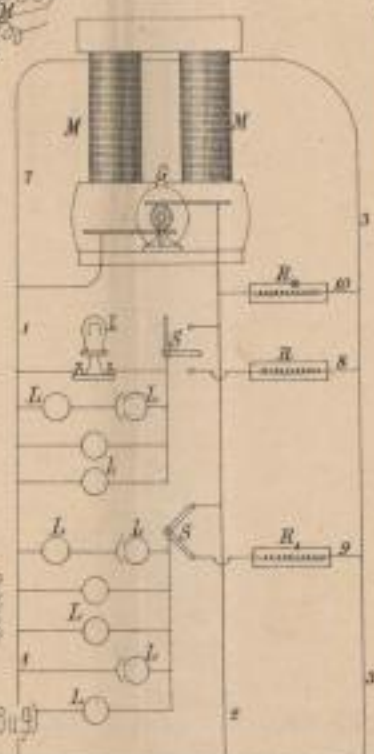

Fig. 8.



der Stromerzeugung bei Dynamomaschinen. (8 u. 9)

Edison's Regulirung

Issh. Anst. v. F. Wern. Darmstadt

Fig. 9.

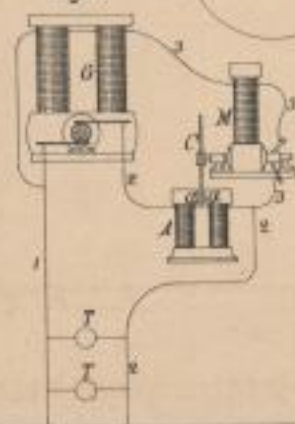

Société Tarare. (13)

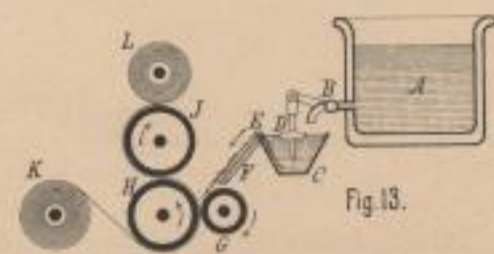

Fig. 13.



Neuerungen im Eisenhüttenwesen. (1-8)

F. Dick und J. Riley. (6)

H. Neumeyer's bez. W. Schneider's Entfettungsapparat. (9 u. 10 bez. 11)

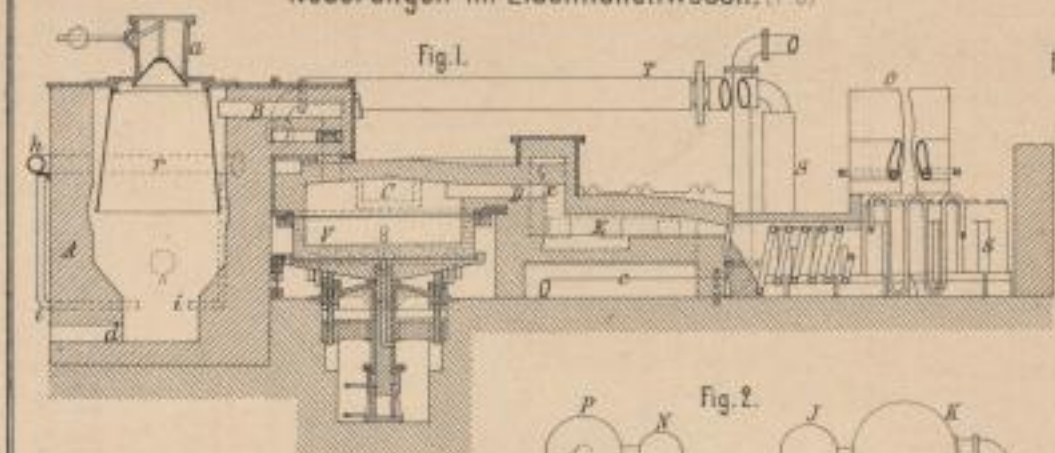

Fig. 1.

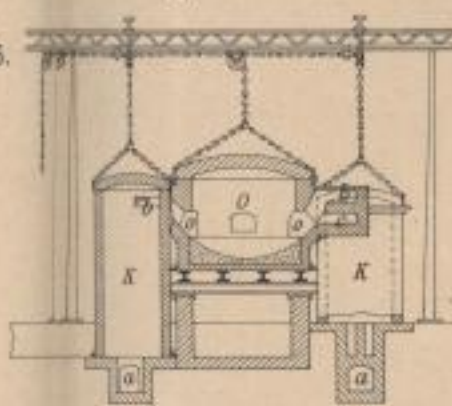

Fig. 6.

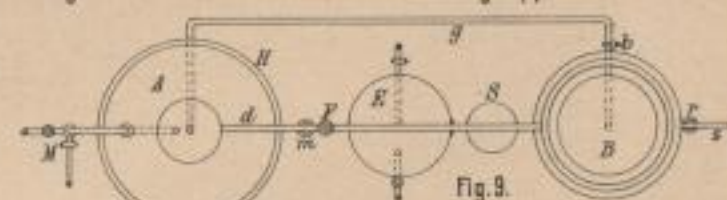

Fig. 9.

I. Henderson. (1 u. 2)

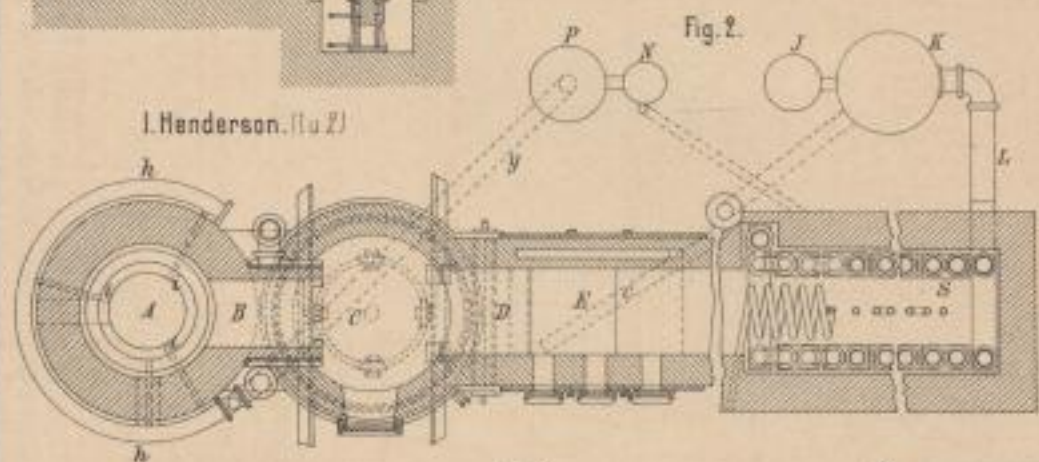

Fig. 2.

R. Wilson bez. C. Wetter. (7 u. 8)



Fig. 7.

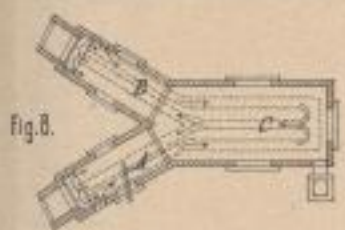

Fig. 8.

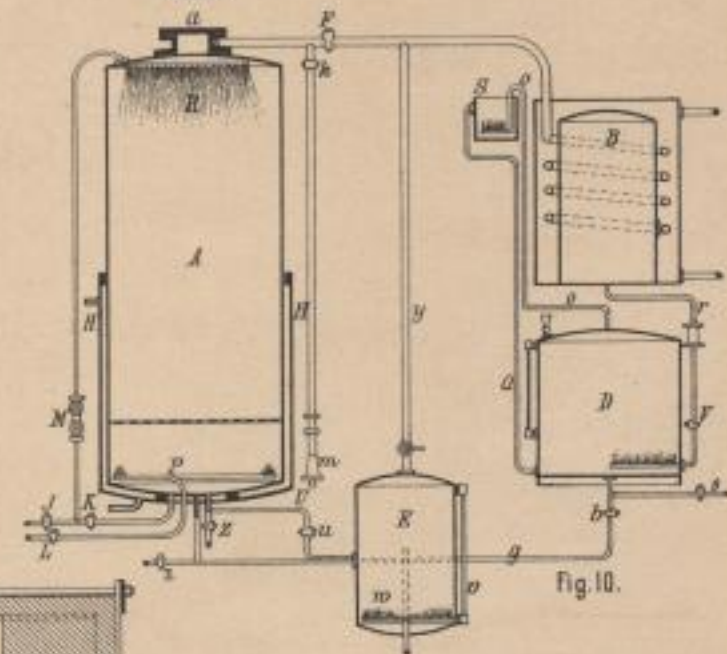

Fig. 10.

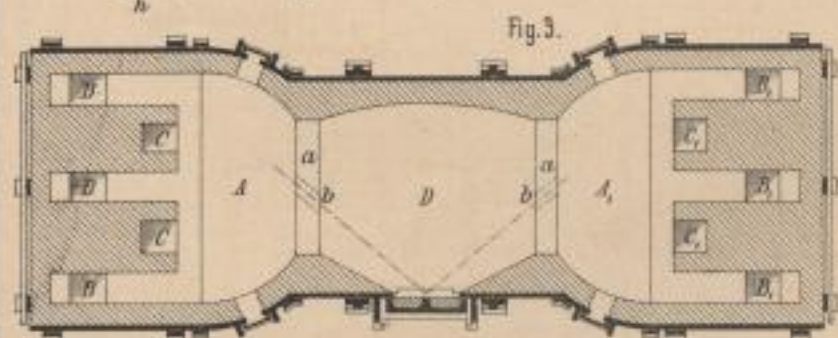

Fig. 3.

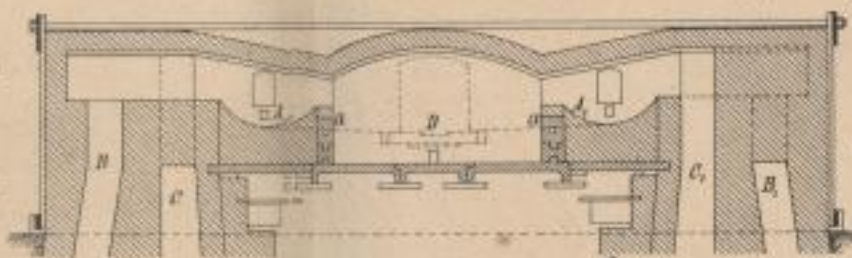

Fig. 4.

[O. Springer. (3 u. 4)]

B. Leuffgen bez. O. Stumpf. (5)

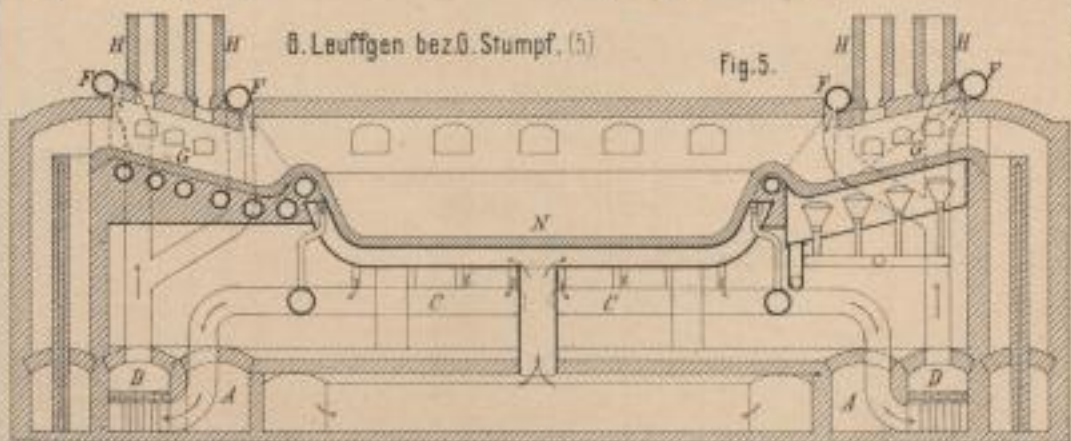

Fig. 5.

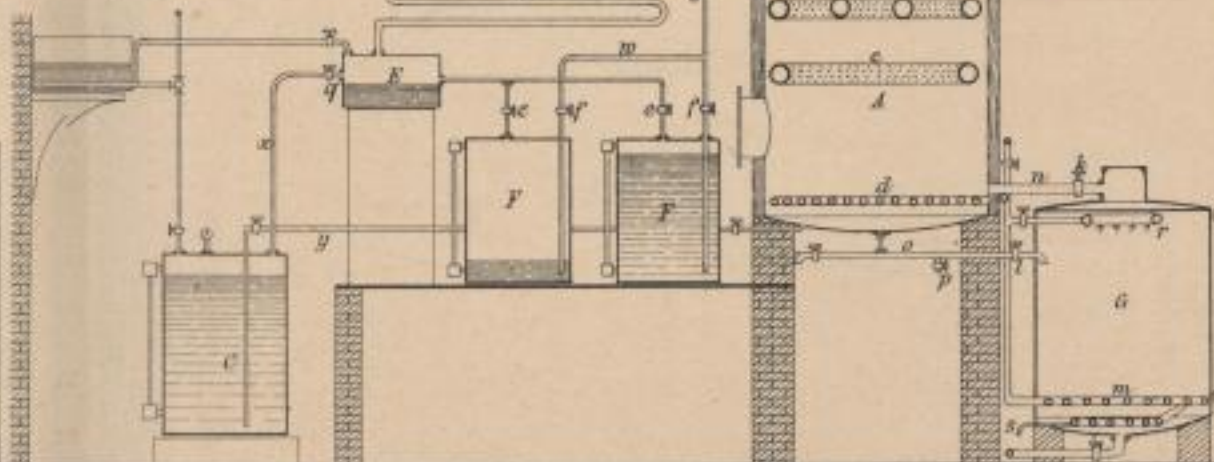
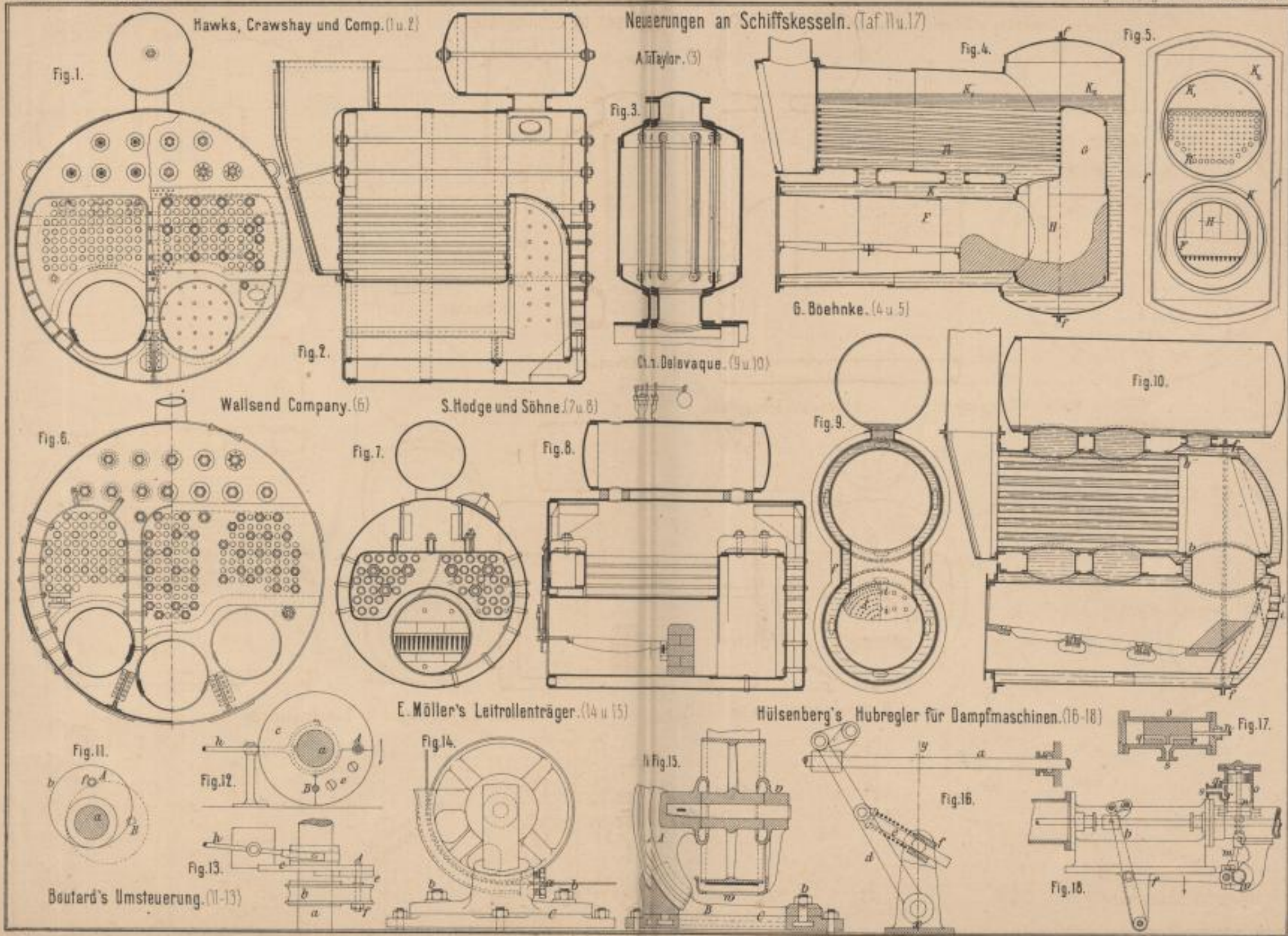

Fig. 11.

Zeich. Anst. v. J. P. W. v. Darmstadt.







Lith. Anst. v. J. Neumann, Neudamm.







Neuere chemische Apparate für Fabrikbetrieb. (Taf. 13)

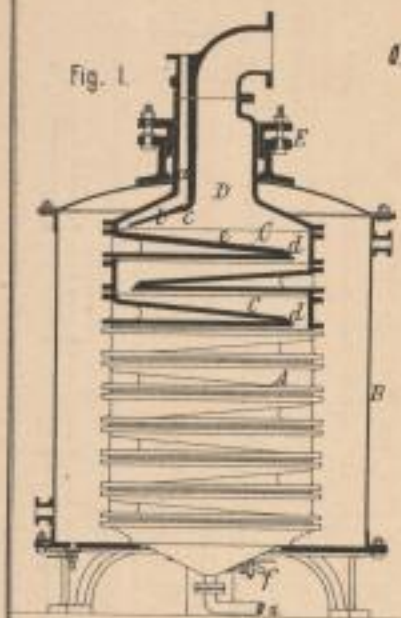

Fig. 1.

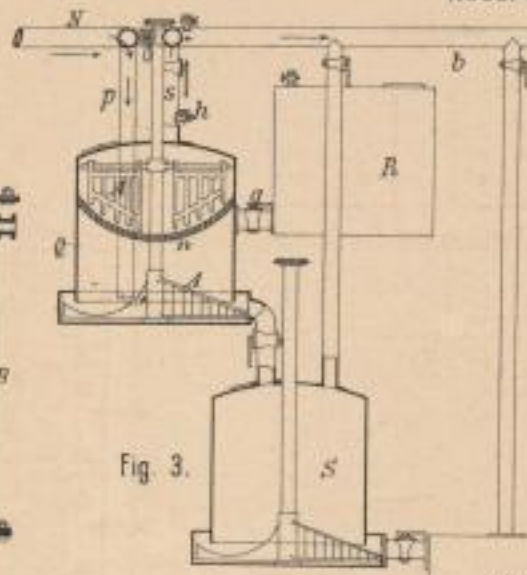

Fig. 3.

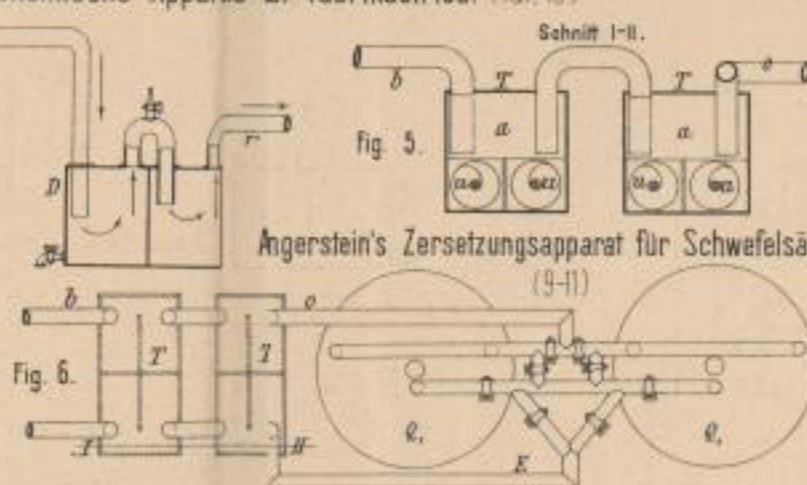

Fig. 5.

Angerstein's Zersetzungsapparat für Schwefelsäure. (9-11)

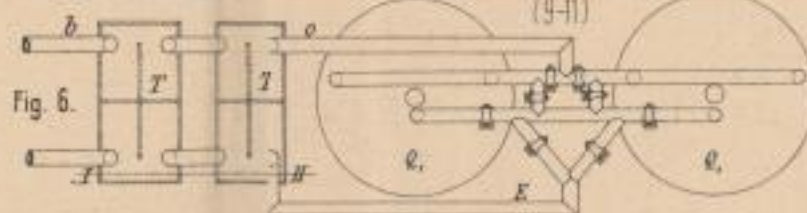

Fig. 6.

Rawes' Gewinnung von Schwefel aus Sodarückständen. (3-8)

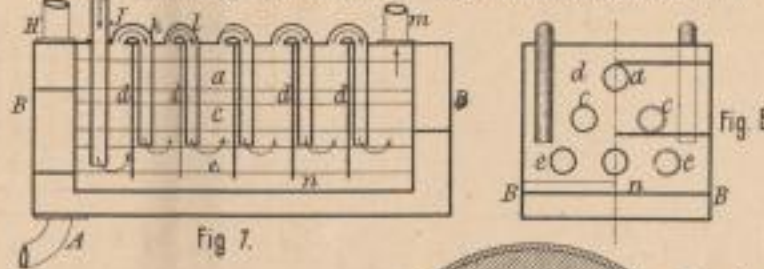

Fig. 7.

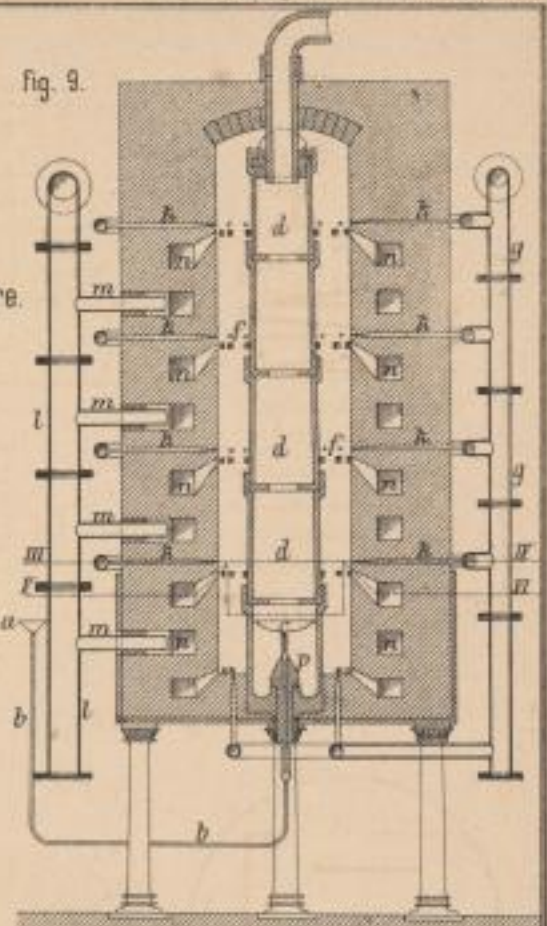

Fig. 9.

H. Egells' Verdampfapparat. (1u 2)

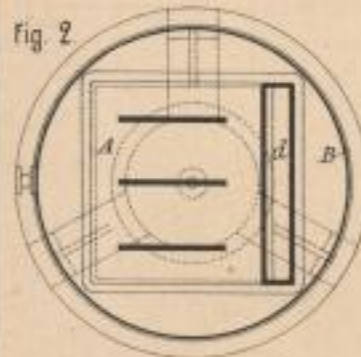

Fig. 2.

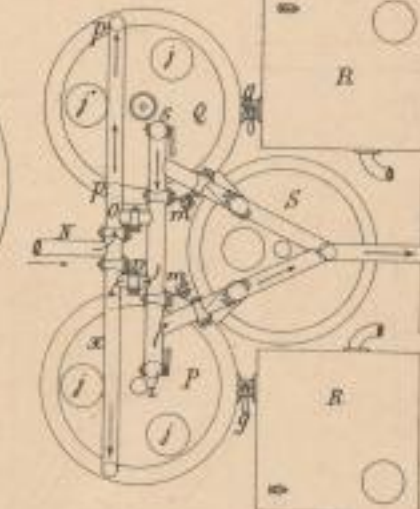

Fig. 4.

Weidon's Herstellung von Chlor. (12u13)

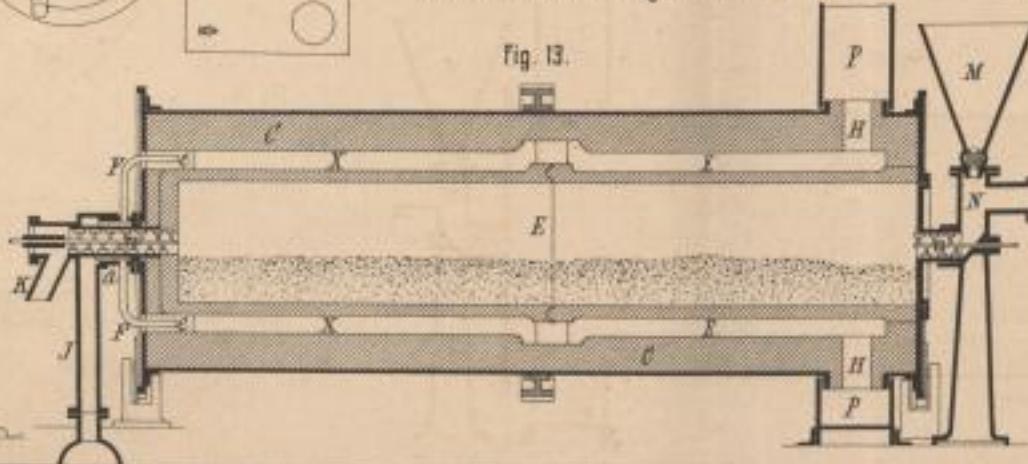

Fig. 13.

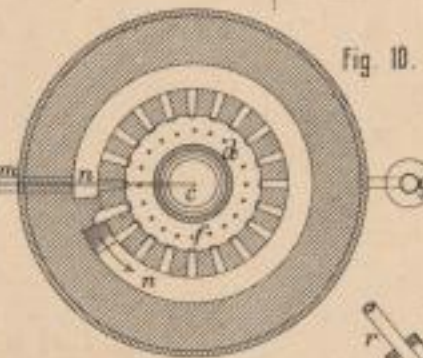

Fig. 10.

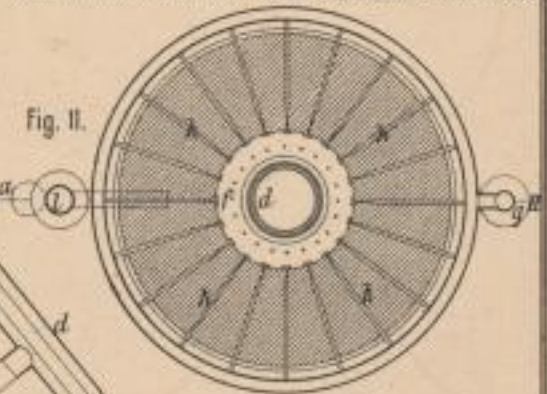

Fig. 11.

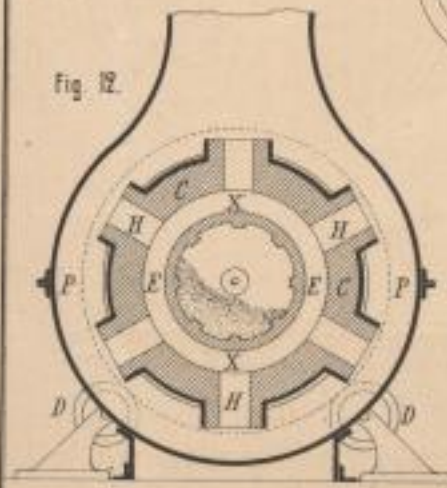

Fig. 12.

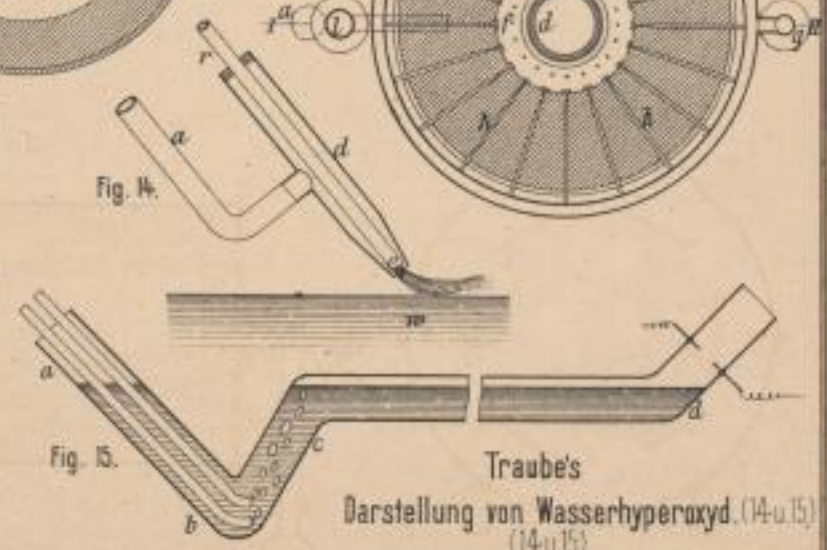

Fig. 14.

Fig. 15.

Traube's Darstellung von Wasserhyperoxyd. (14u15) (14u15)

Lith. Anst. v. F. Pirck, Darmstadt.



Steinkohlenförderung in Tonnen. (I)



Worth der geförderten Steinkohlen. (II)



Worth der Tonne Steinkohle. (I)



Verunglückungen mit tödlichem Ausgange. (7 u. 8)

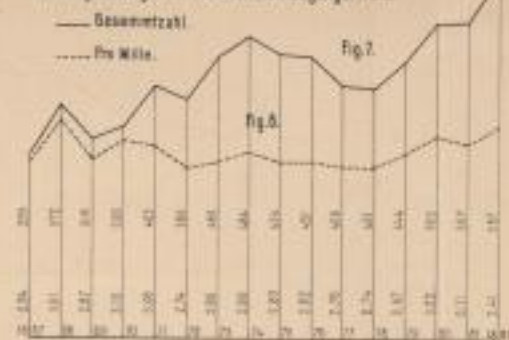

Rohisen. Jahreserzeugung in Tonnen. (I)



Rohisen. Jahreserzeugung in Mark. (II)

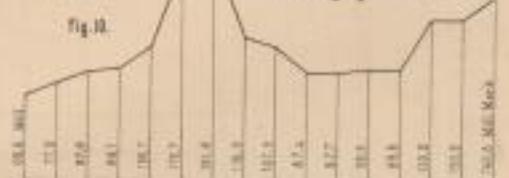

Rohisen. Jahreserzeugung in Mark. (III)



Rohrzucker. Jahreserzeugung in Kilogramm. (I)



Preis pro 100 Kilogramm Rohrzucker. (II)



Rohrzucker. (I u. II)

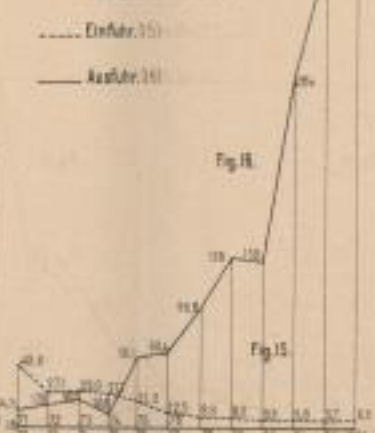

Fleischverbrauch in Kilogramm pro Kopf der Bevölkerung. (I)

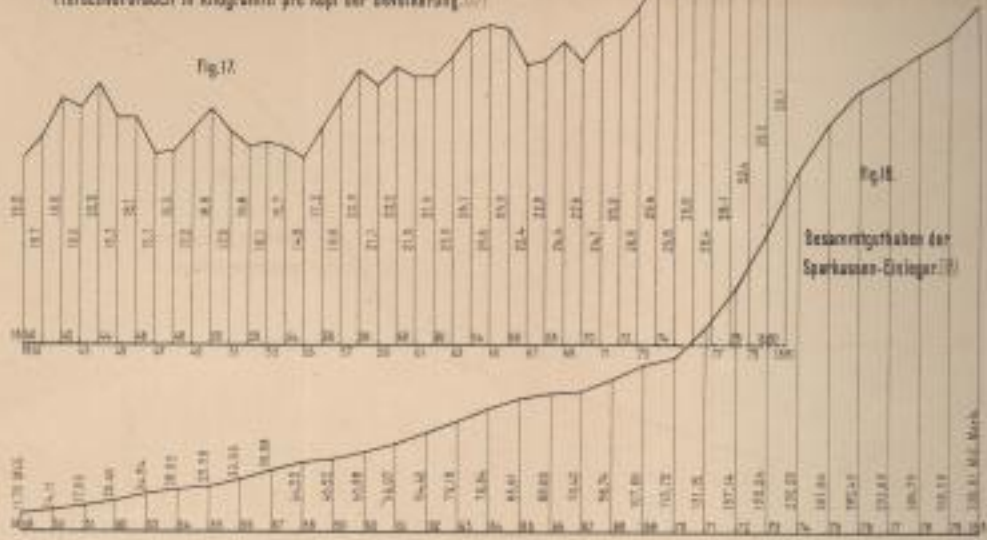

Sparkassen-Einzahlungen in Mill. Mark. (I)

Sparkassen-Rückzahlungen in Mill. Mark. (II)

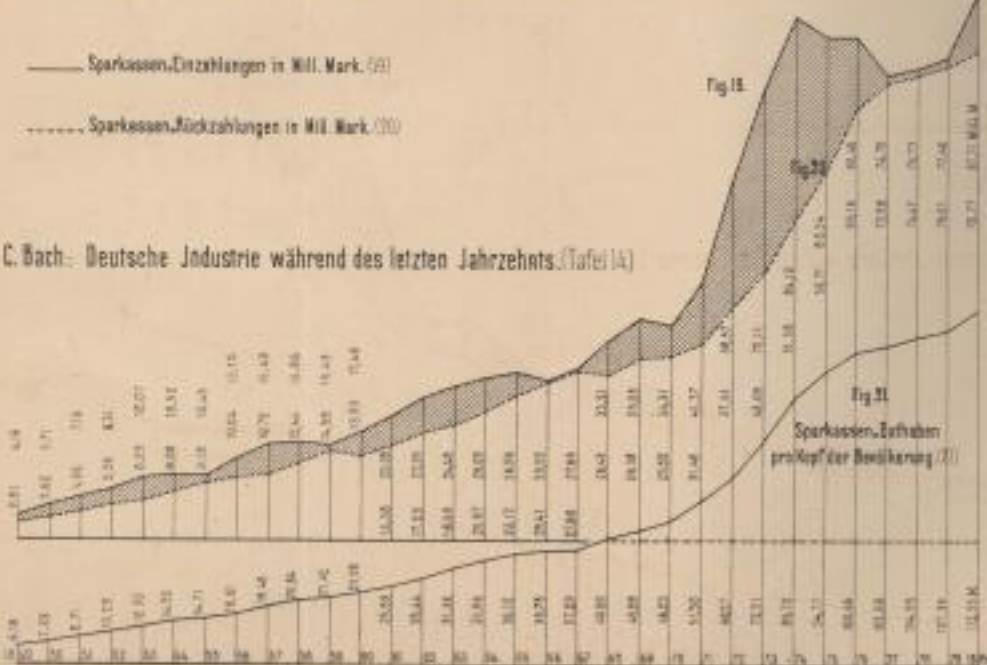

C. Bach: Deutsche Industrie während des letzten Jahrzehnts. (Tafel 14)

Sparkassen-Einträge pro Kopf der Bevölkerung. (I)

Leistung pro Arbeiter in Tonnen jährlich geförderter Steinkohle. (I)



Anzahl der Arbeiter. (II)



Durchschnittspreis pro Tonne. (I)

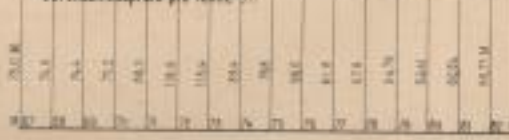

Quelle: Archiv für Völk. Statistik





### Neuerungen an Spiralbohrer-Schleifmaschinen. (1-12)

J. H. Johnson. (3-6)

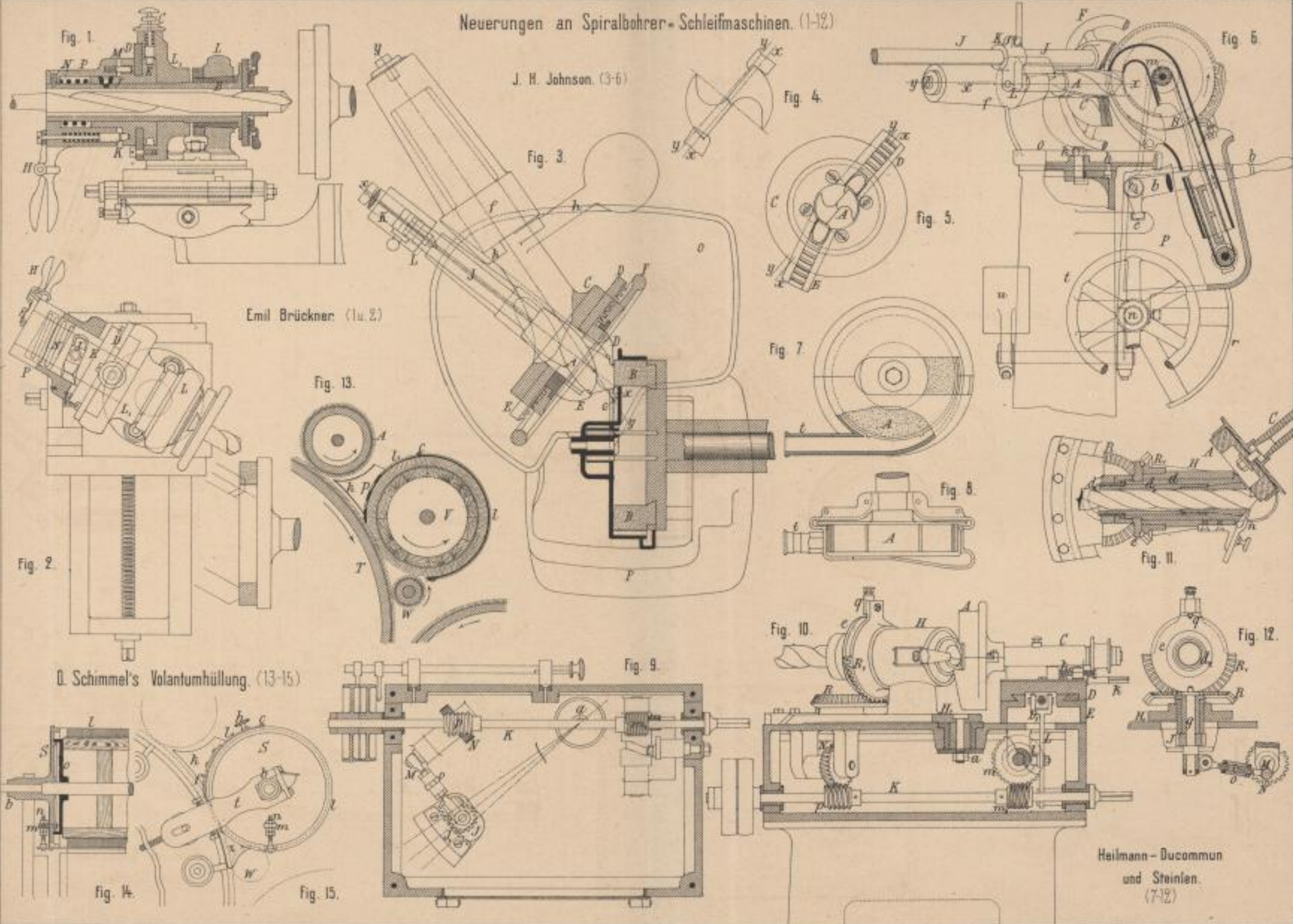

Emil Brückner. (1u. 2)

D. Schimmel's Volantumhüllung. (13-15)

Heilmann-Ducommun  
und Steinien.  
(7-12)

Lith. Anst. v. F. Wirtz, Darmstadt.



A. Klönne's Regenerativfeuerung für Retortenöfen. (1-10)

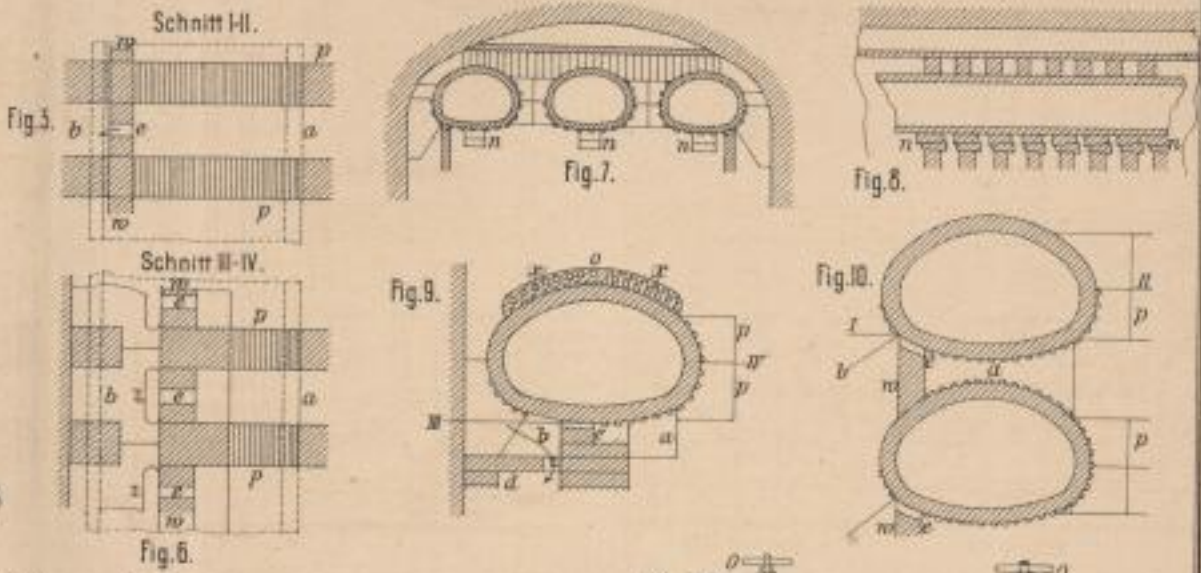
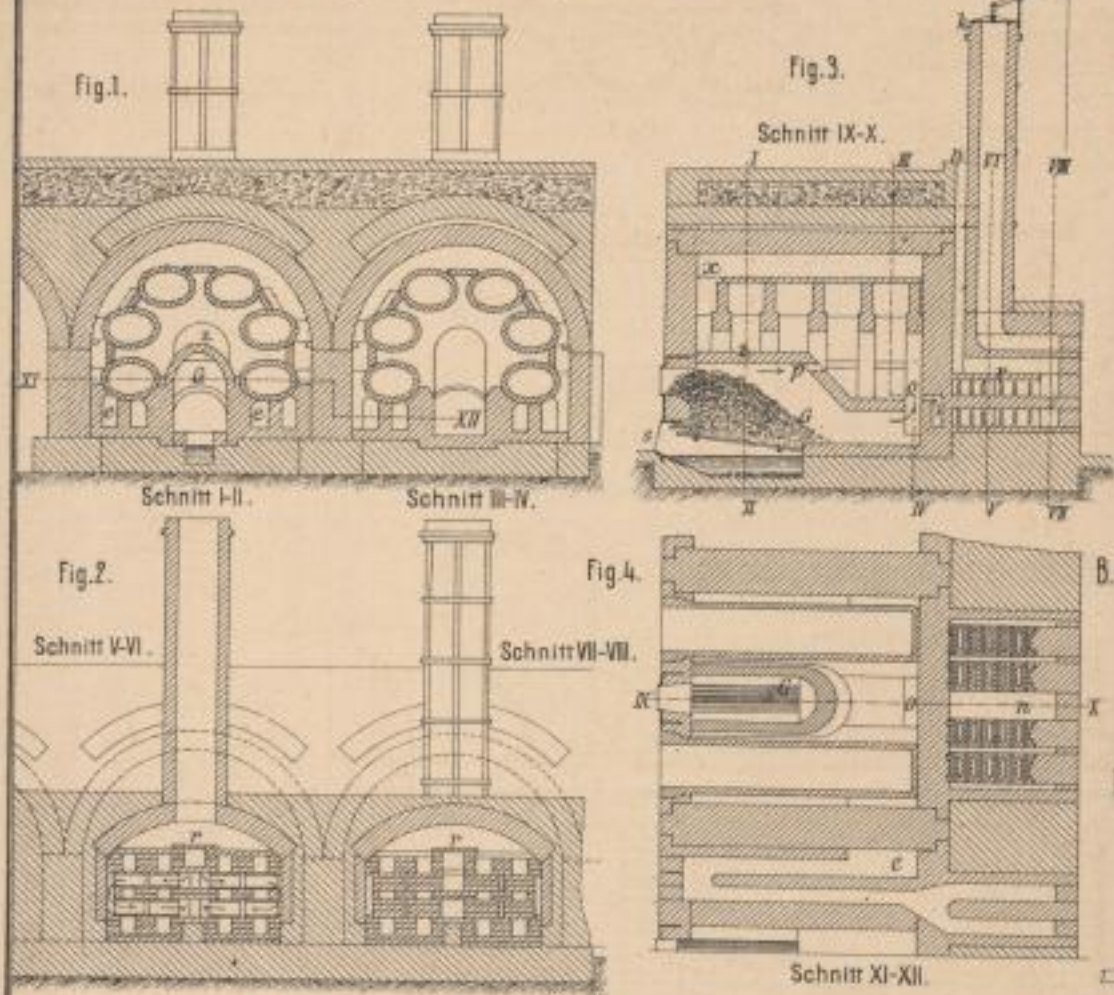

W. Bäcker's Gasgeneratoröfen. (13 u 14)

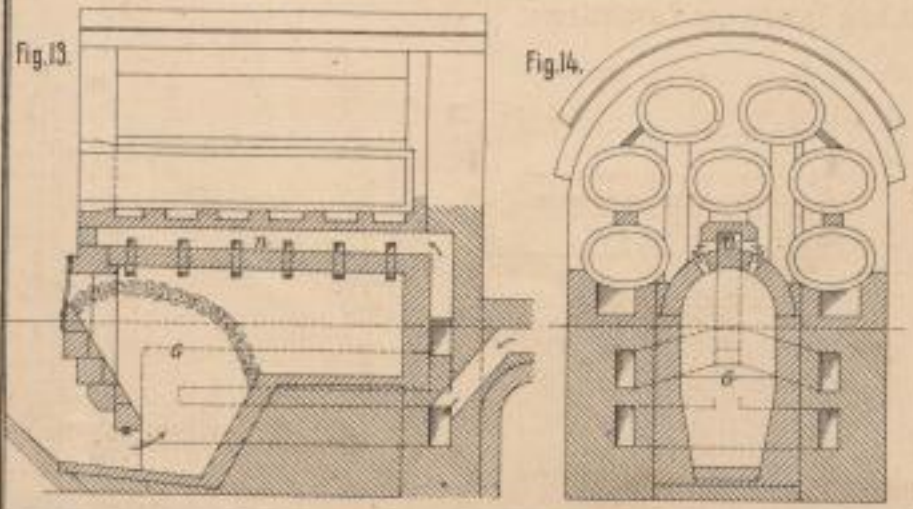

B. Walker und J. Bennett's Vergasungsapparat. (11 u 12)

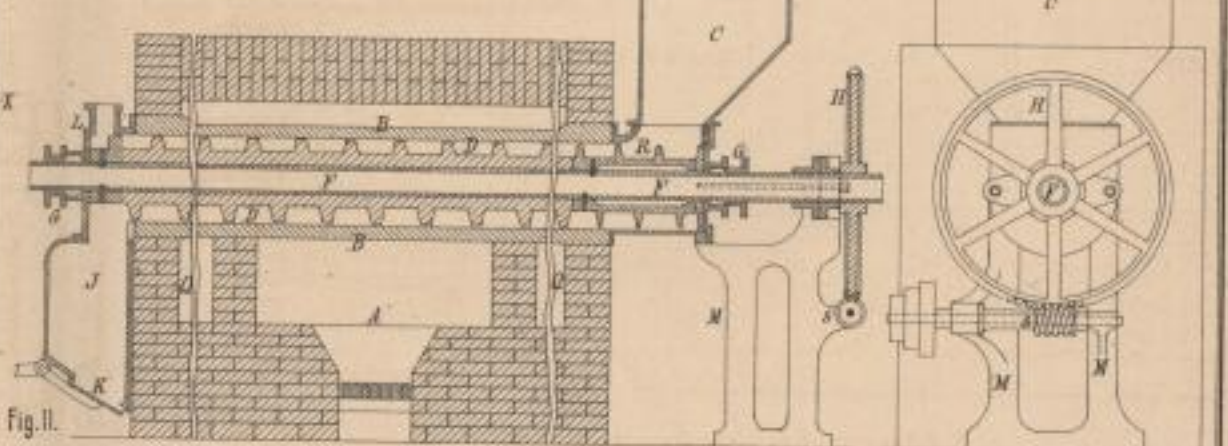

A. Roller's Apparat zum Tunken von Zündhölzern. (15-17)

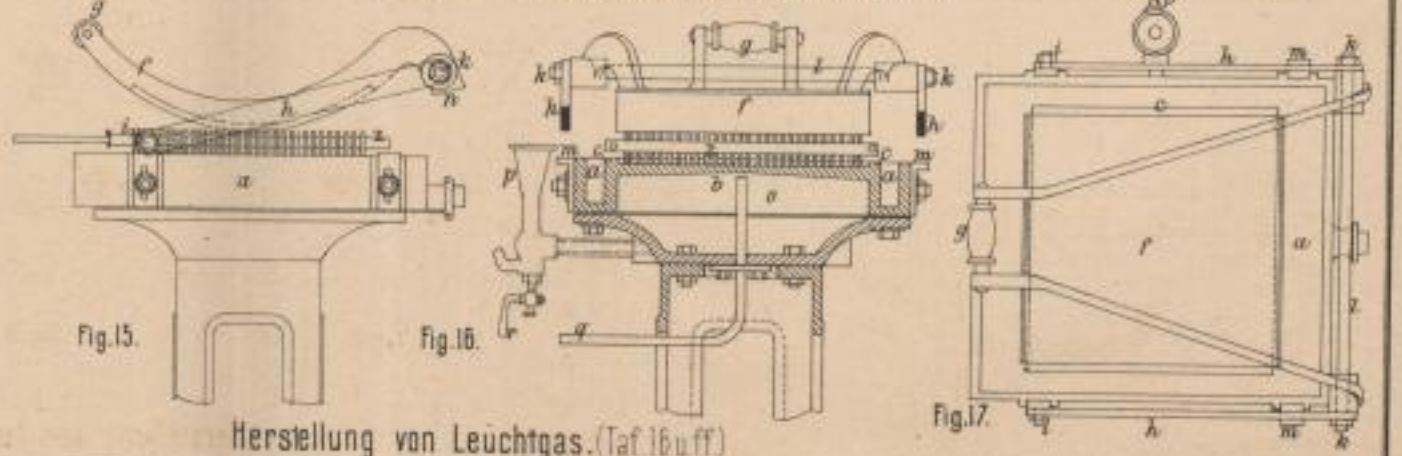

Herstellung von Leuchtgas. (Taf 16 u ff.)

Lith. Anst. v. F. Wirtz. Darmstadt.



Neuerungen an Schiffskesseln. (Taf. II u. 17)

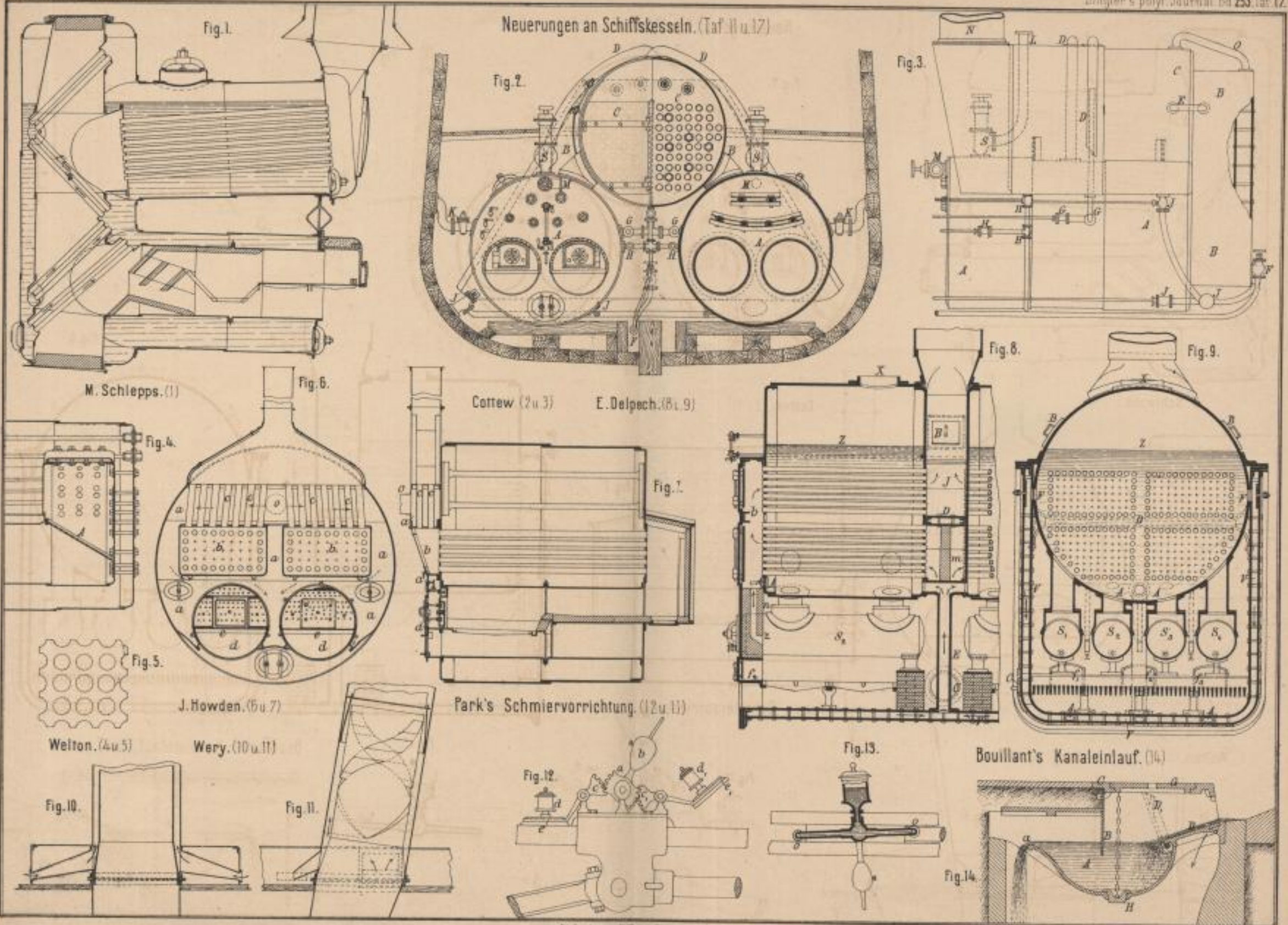

M. Schlepps. (1)

Cottew (2 u. 3) E. Delpech. (8 u. 9)

J. Howden. (6 u. 7)

Park's Schmiervorrichtung. (12 u. 13)

Bouillant's Kanaleinlauf. (14)

Welton. (4 u. 5)

Wery. (10 u. 11)

Lith. Anst. v. F. Wilm. Darmstadt



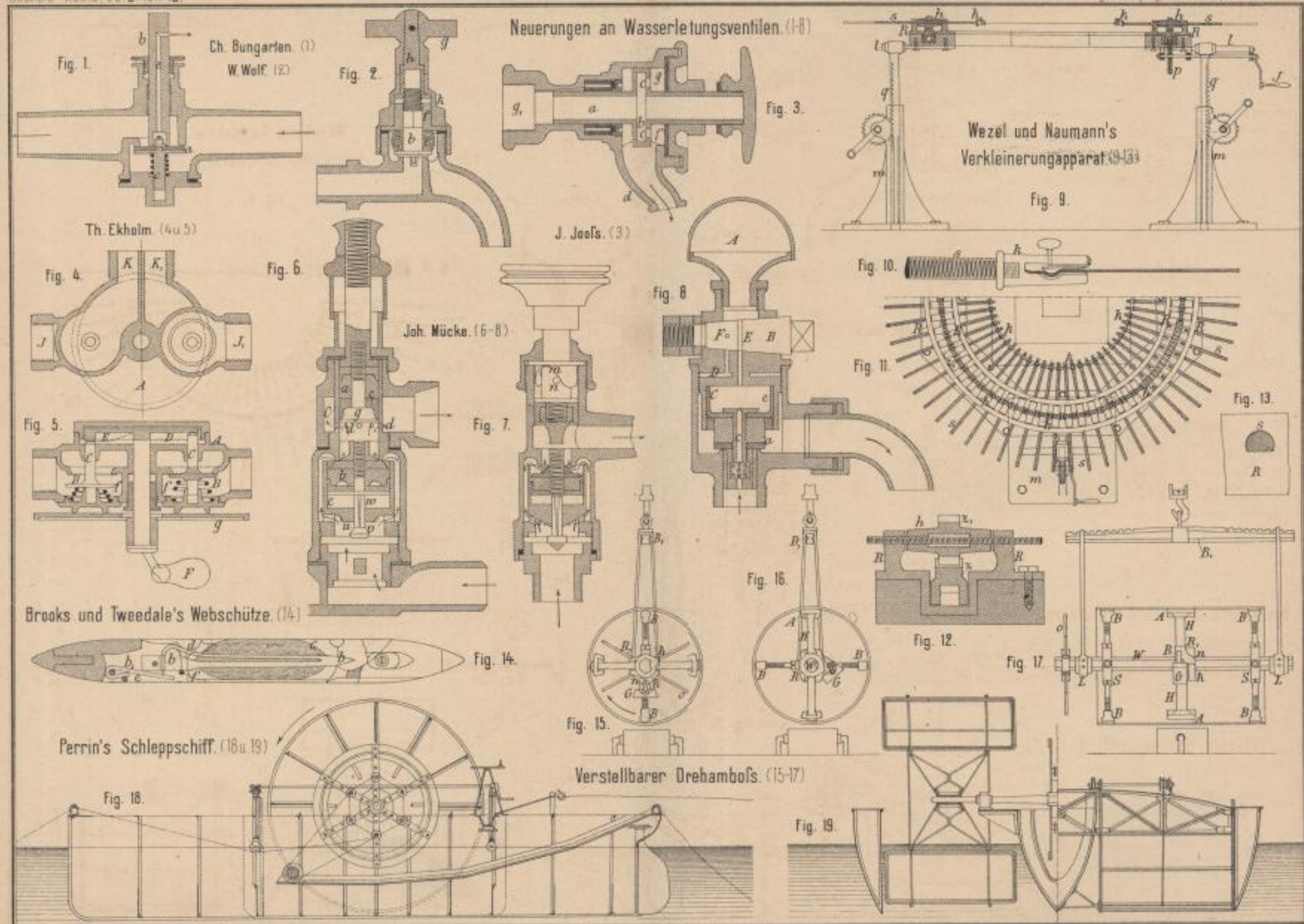

Neuerungen an Wasserleitungsventilen. (1-8)

Wezel und Naumann's Verkleinerungsapparat (9-13)

Verstellbarer Drehbofs (15-17)

Lith. Anst. v. E. Wroch, Darmstadt.



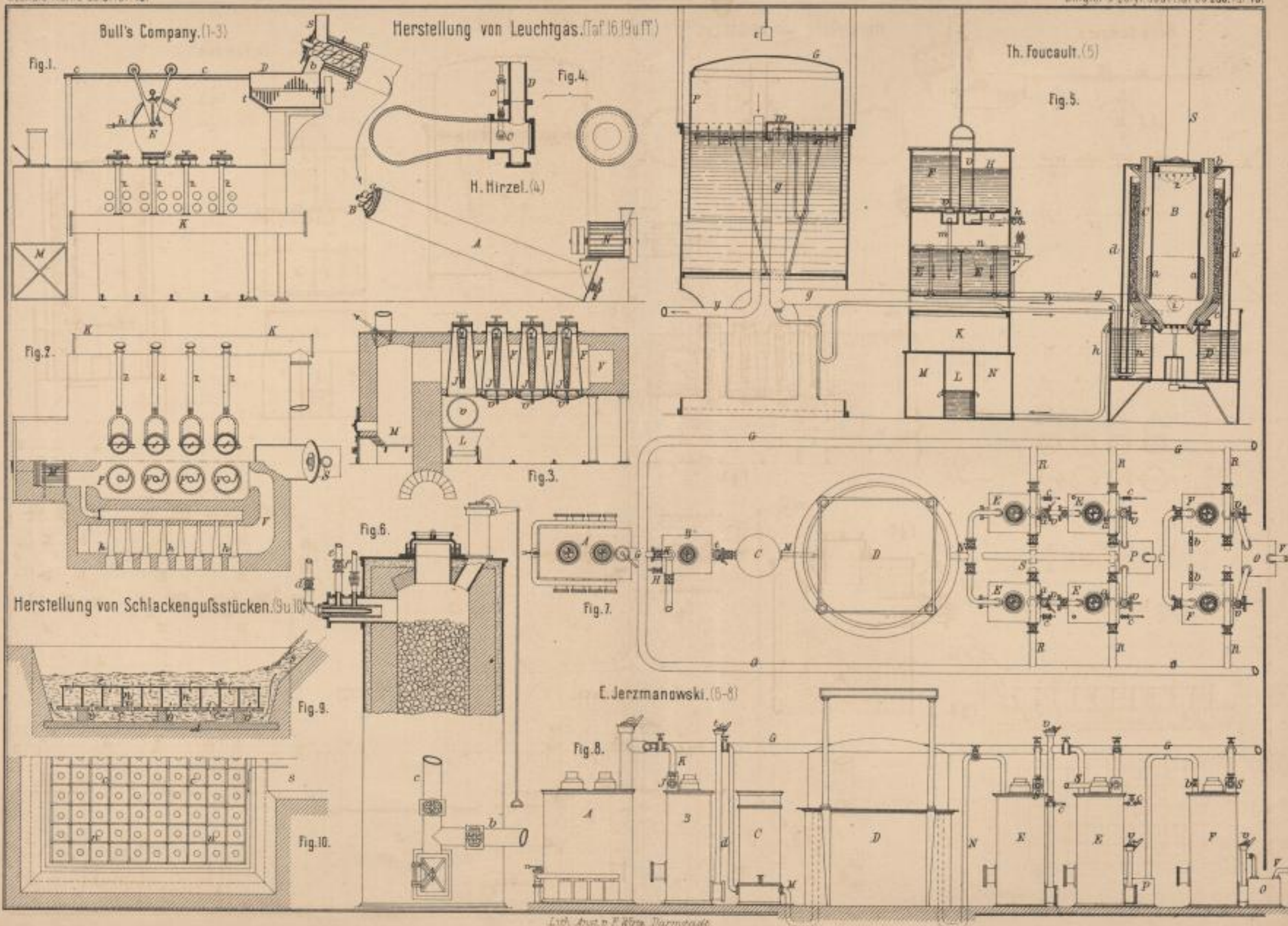



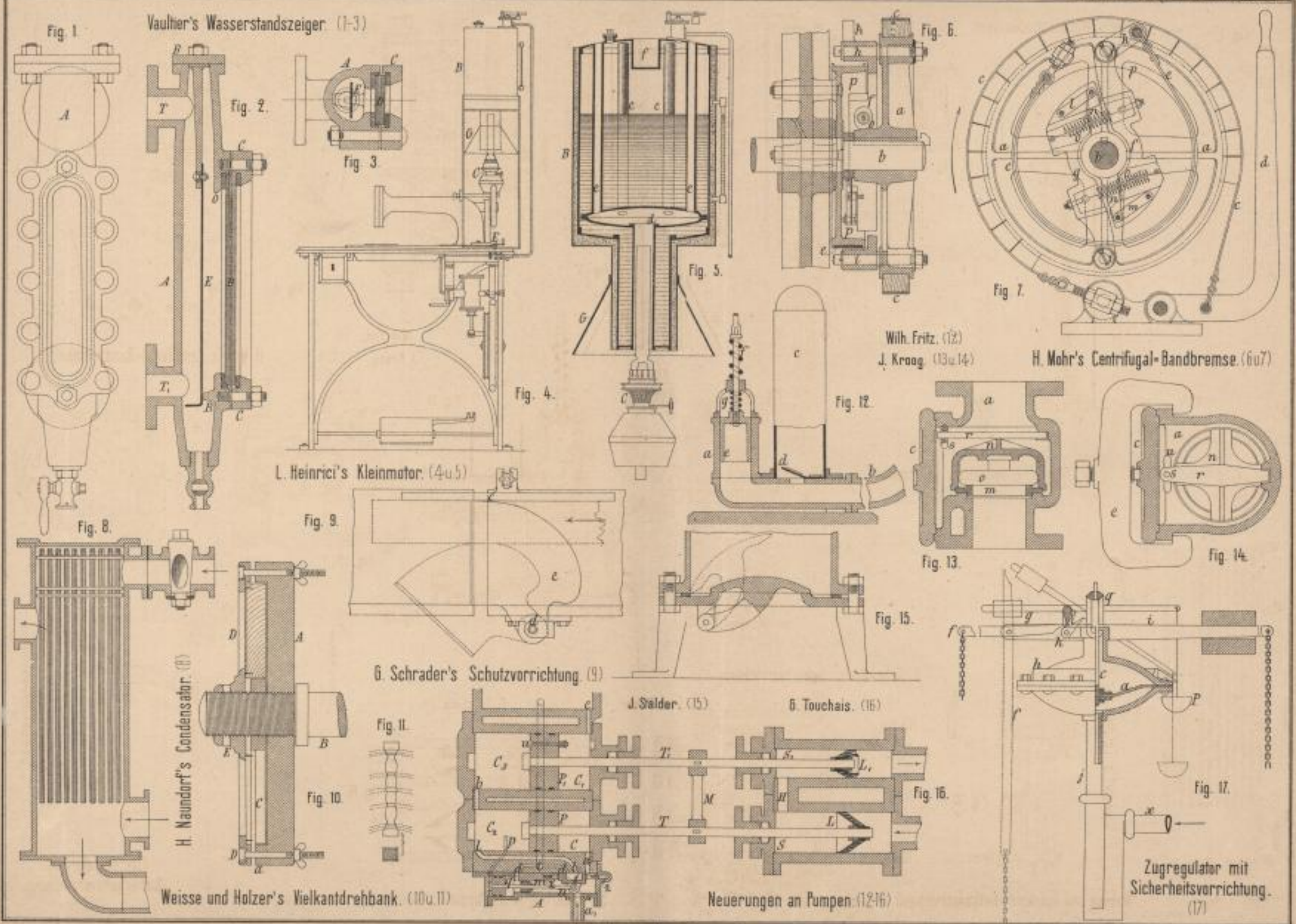

Verf. v. F. Wirt, Darmstadt.



O. Heym's Wärmofen. (1-2)

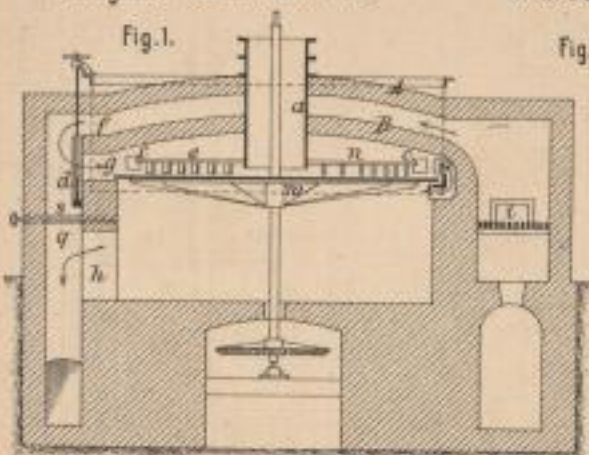

H. Kirberg's Herstellung von Bleiweiß. (3-5)

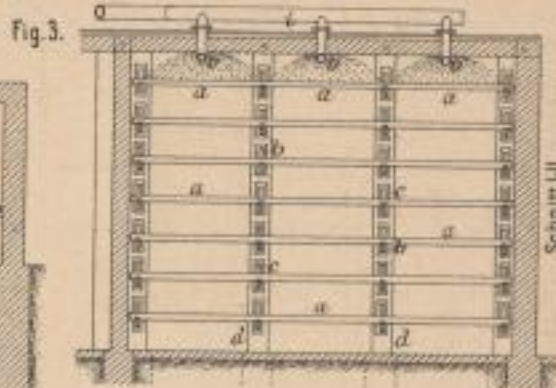
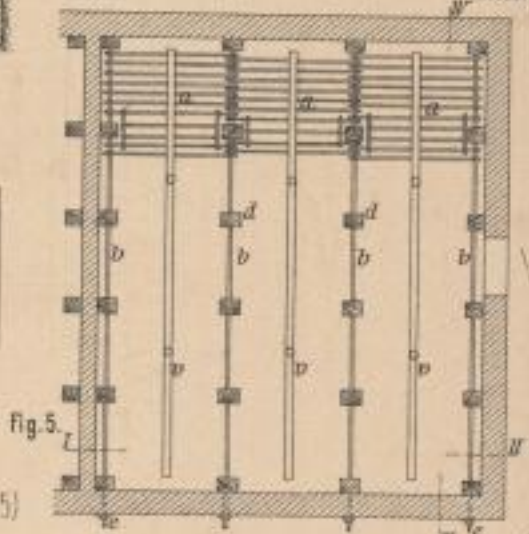
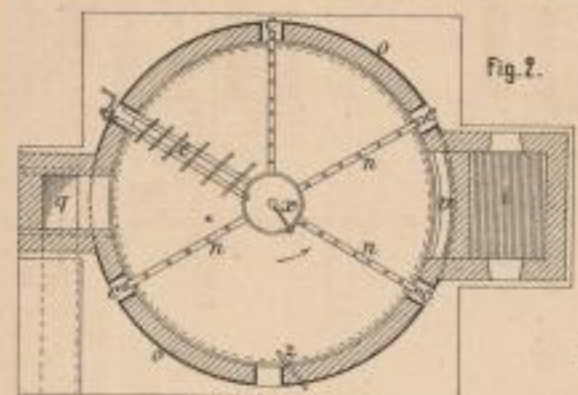

Fig. 2.



Elektrische Bogenlampe. (7-9)



Schnitt III-IV.

Fig. 12.

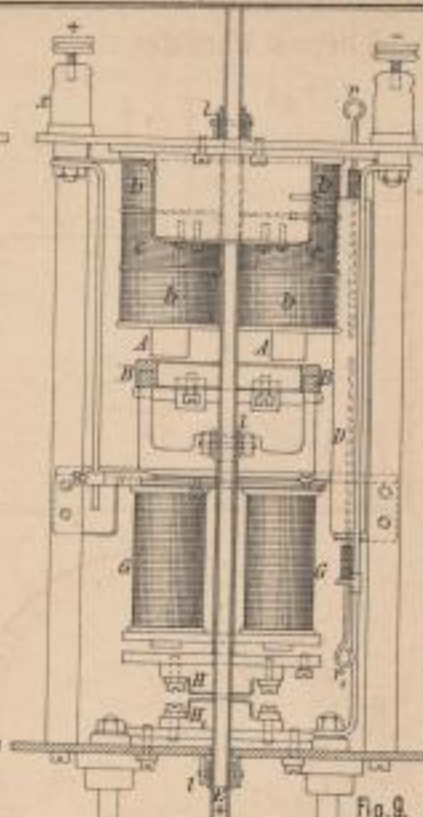
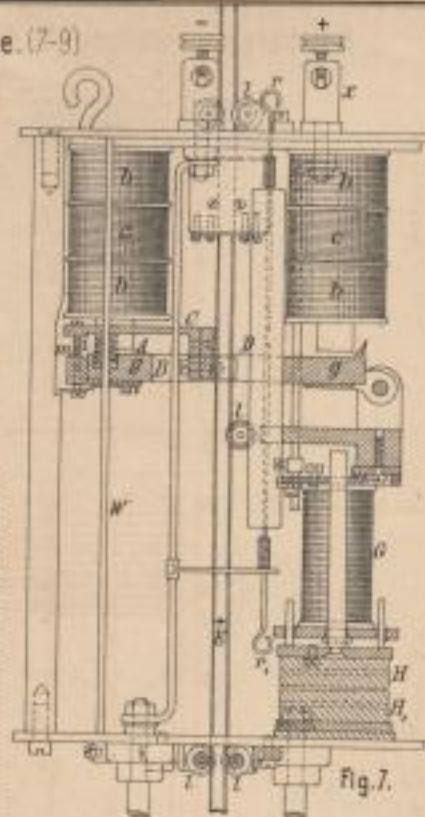
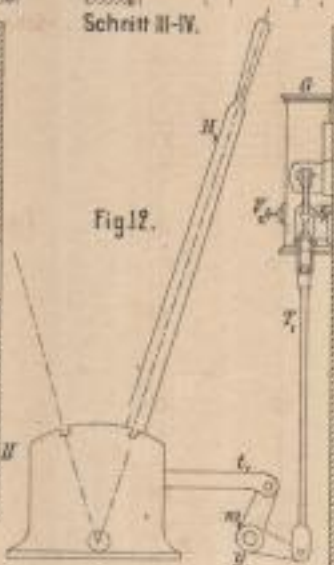

Postel-Vinay's Eisenbahn-Blocksignalssystem. (10-15)

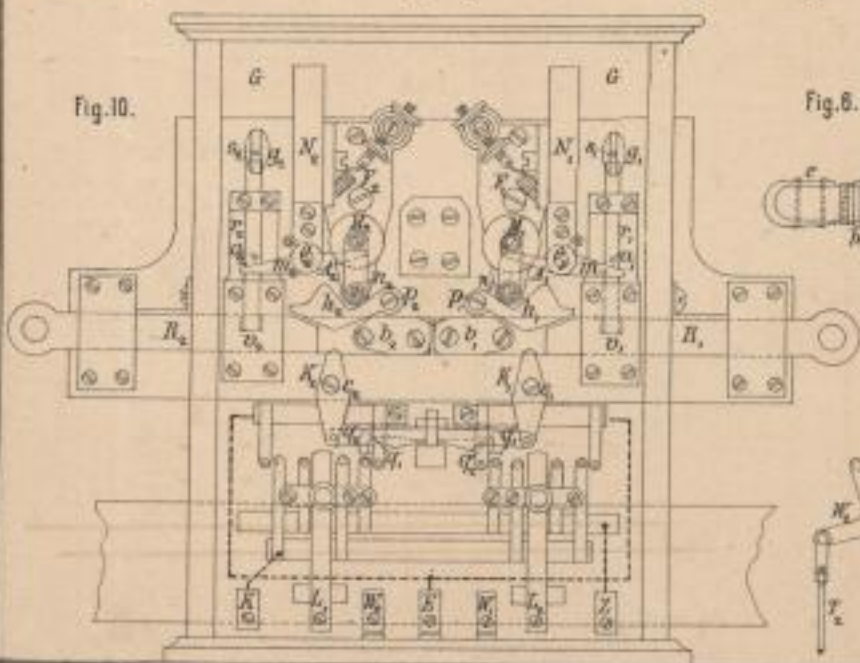

Fig. 8.

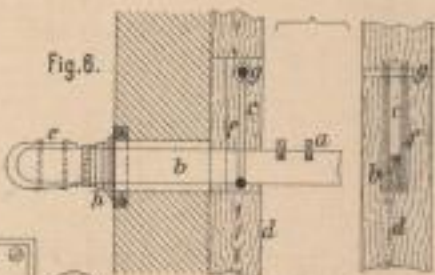

Fig. 11.

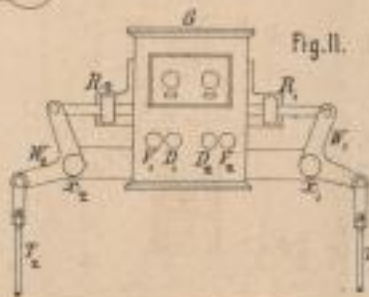

Fig. 13.

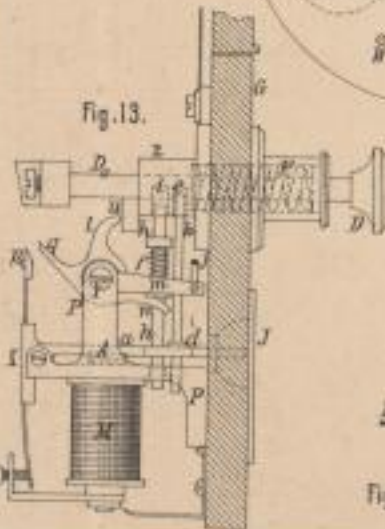

Fig. 14.

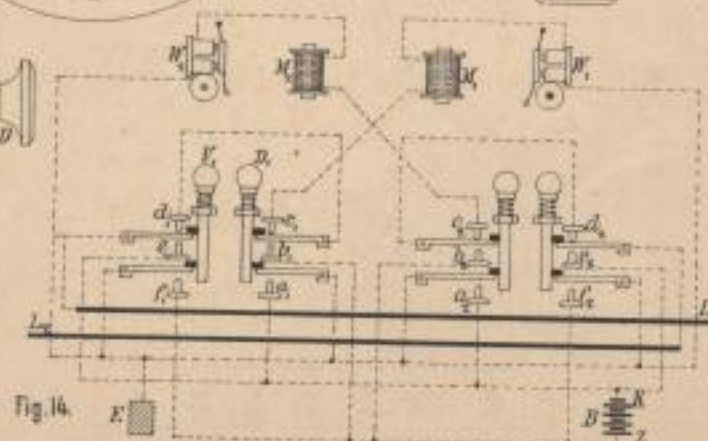
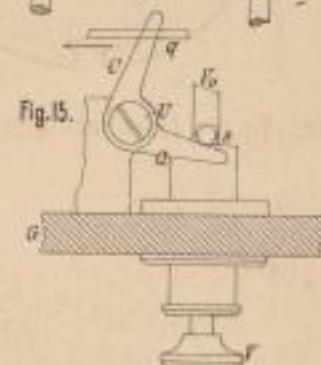

Fig. 15.



Lith. Anst. v. F. Wiese, Darmstadt.



Neuerungen in der Gespinnstfabrikation. (Taf 22)

Neuere Kämmaschinen. (1-25)

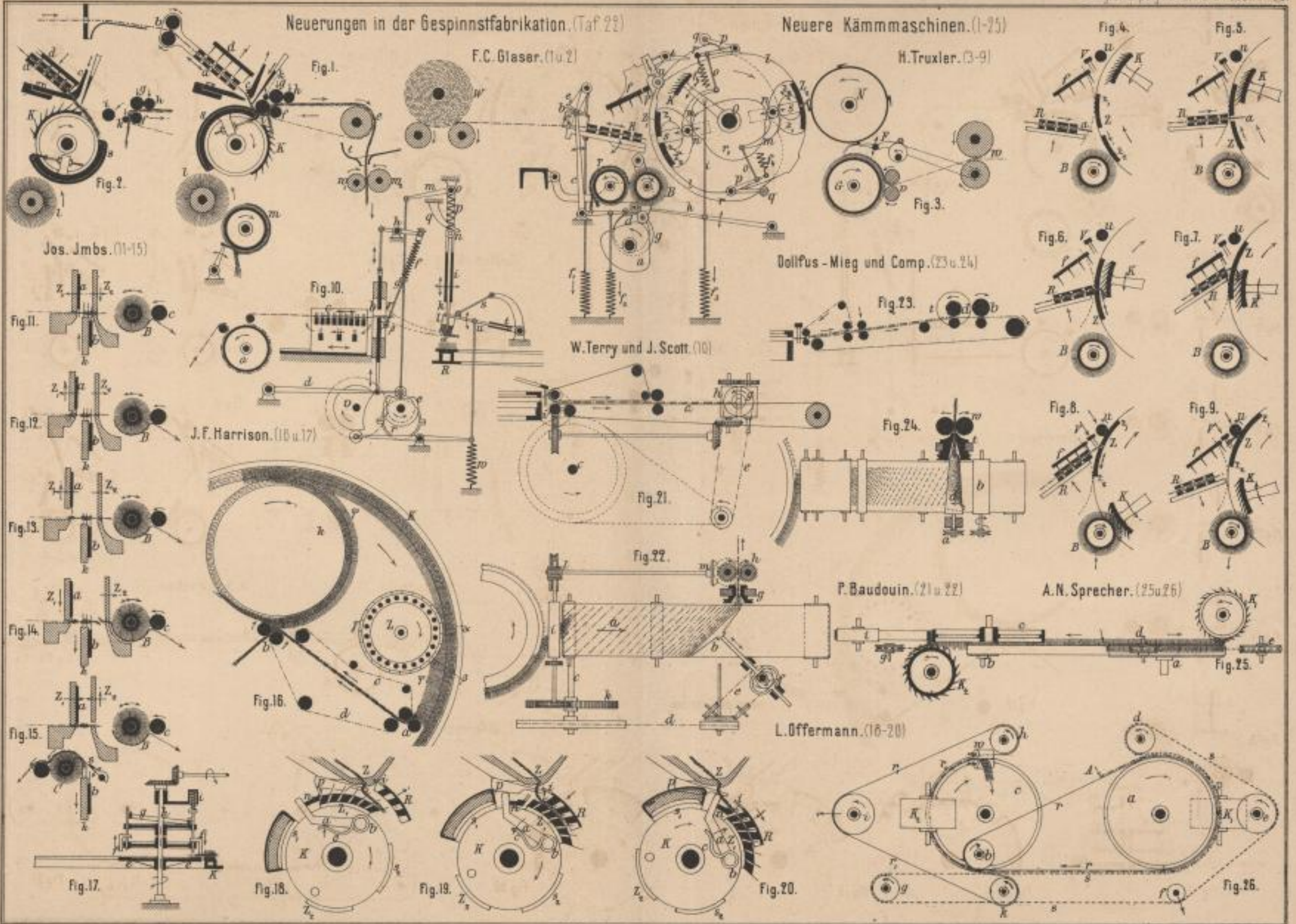

Lith. Anst. v. F. W. W. Barnstadt



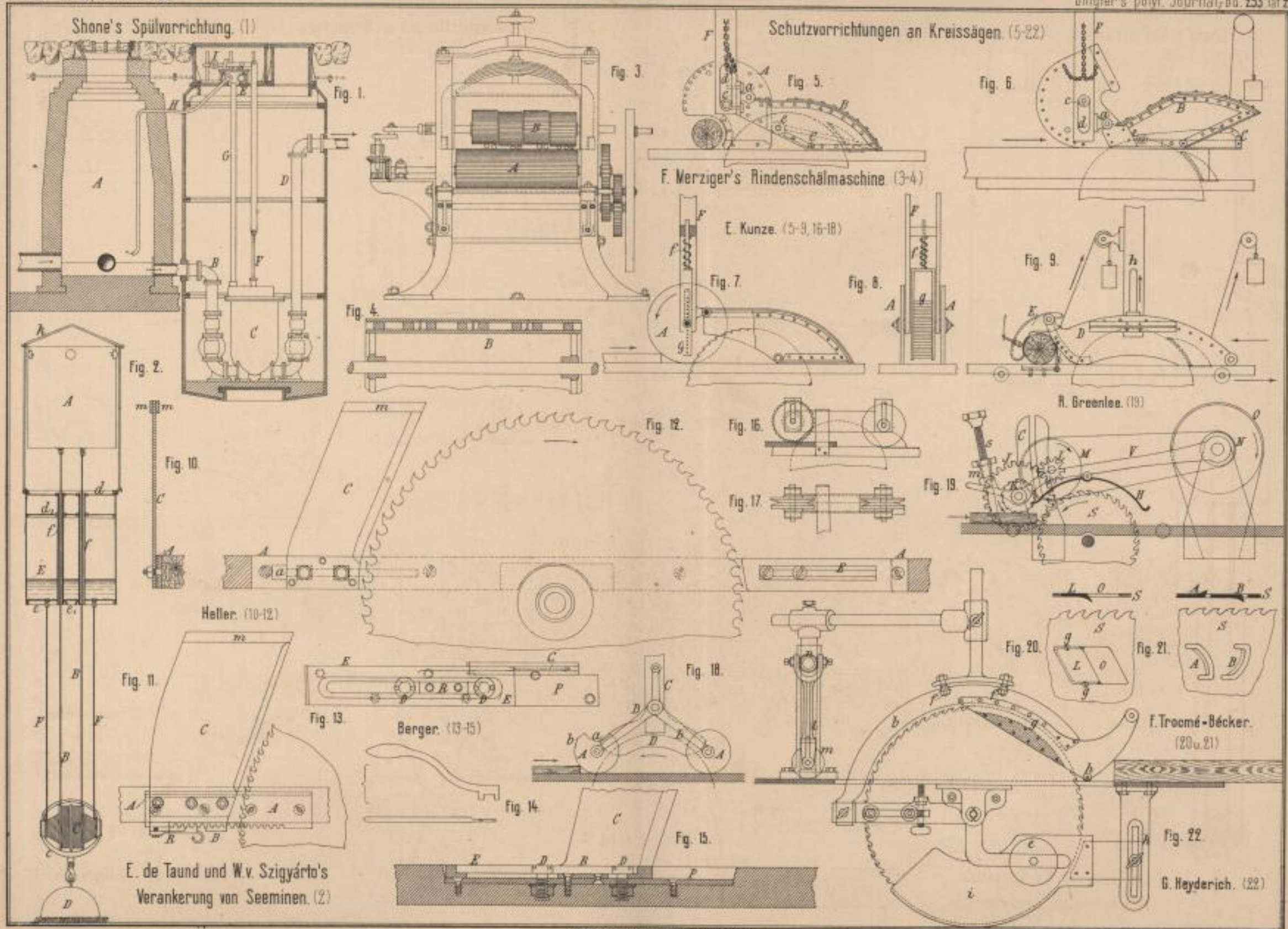

Lith. Anst. v. F. Wirtz, Darmstadt



Apparate zur Gewinnung von Ammoniak (10-14)

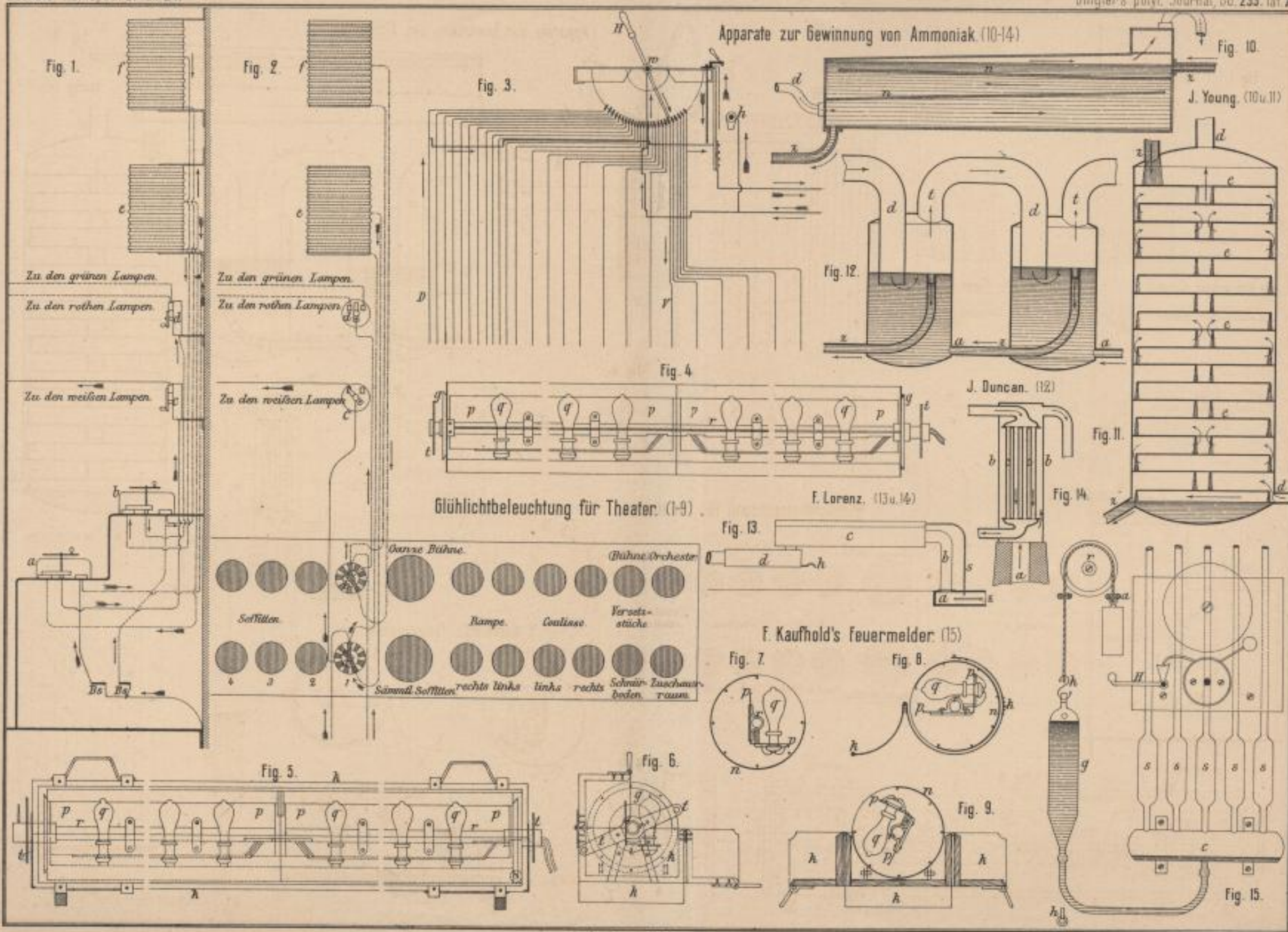

Glühlichtbeleuchtung für Theater. (1-9)

F. Kaufhold's Feuermelder (15)

Lith. Anst. v. F. Wirth, Darmstadt.



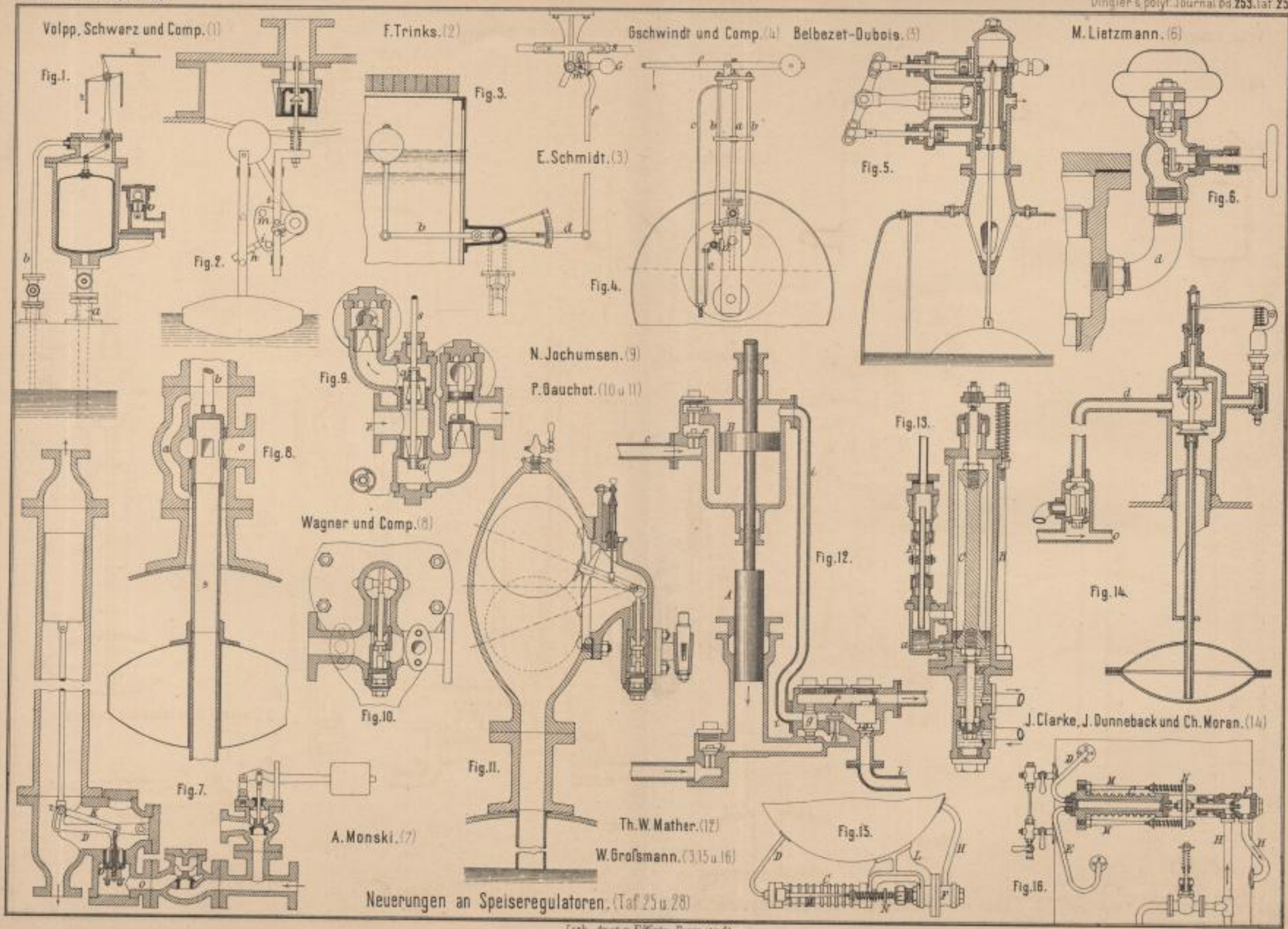

Neuerungen an Speiseregulatoren. (Taf. 25 u 28)

Lith. Anst. v. F. Witzke Darmstadt



Neuerungen in der Gießerei (1-10)

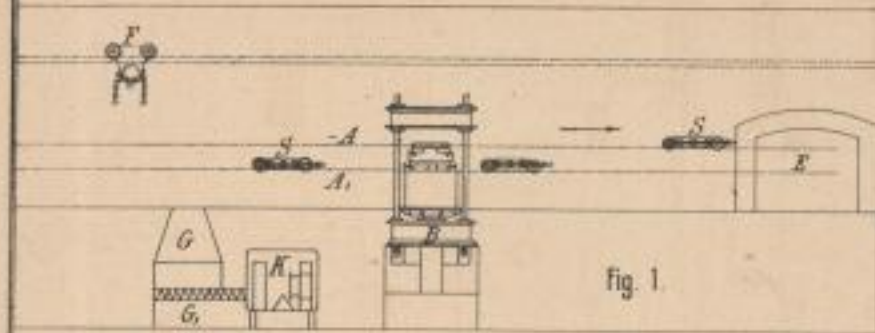

Fig. 1.

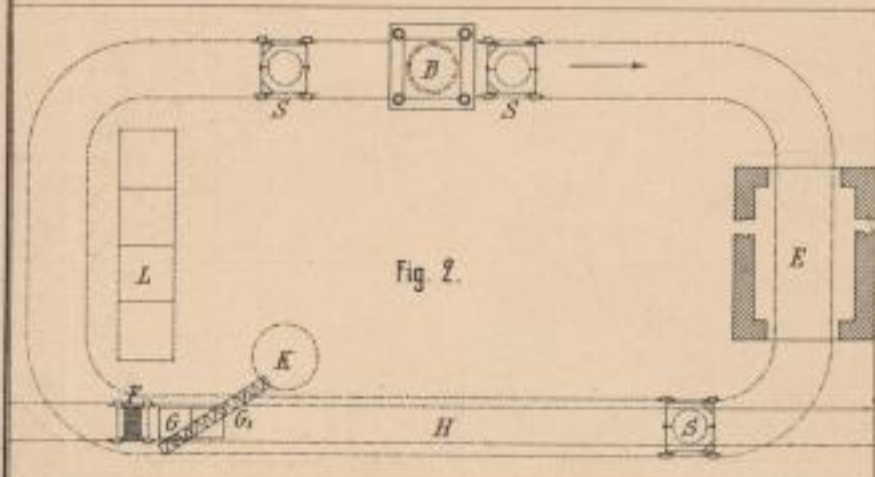

Fig. 2.

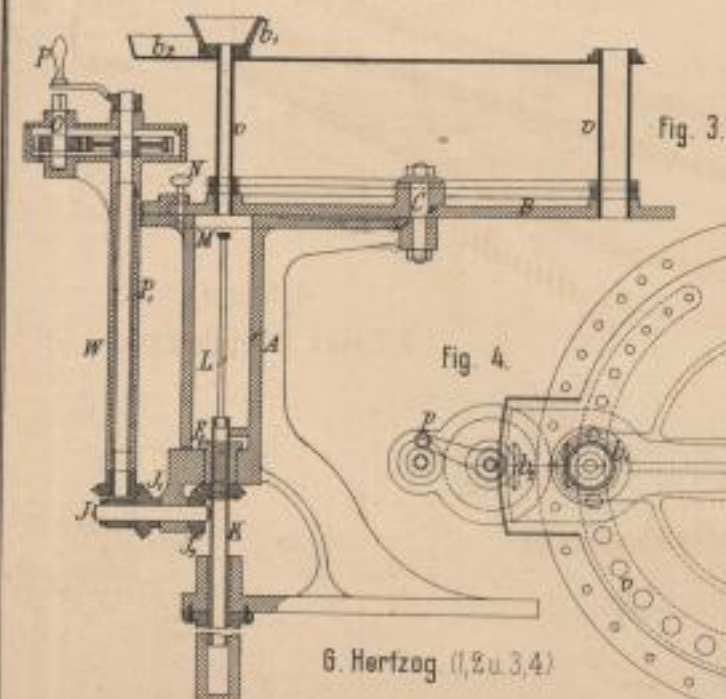

Fig. 3.

Fig. 4.

G. Hertzog (1, 2 u. 3, 4)

Gallas und Aufderheide. (5)

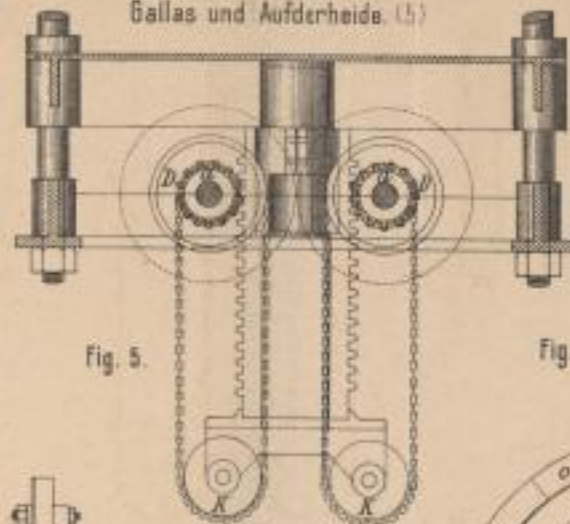

Fig. 5.



Fig. 7.

H. Ehrhard's Schärfapparat für Sägen. (11)

Fig. 11.

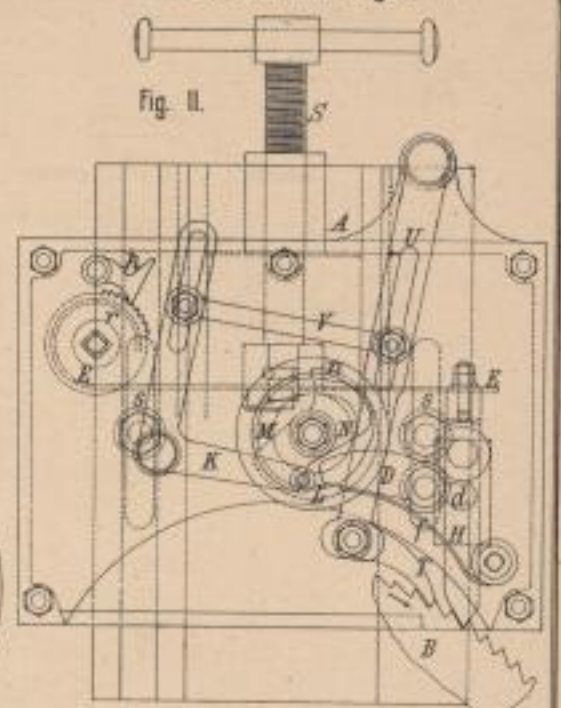

Fr. Sagnes. (6)

Fig. 8.

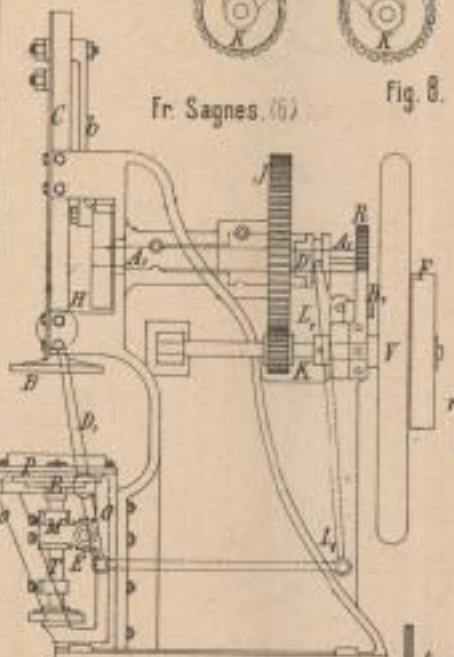

Fig. 6.

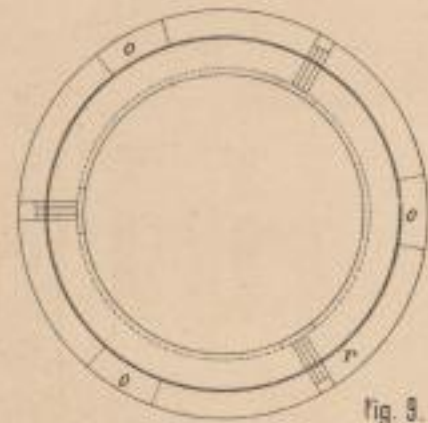

Fig. 9.

J. Kudlicz (7-9)

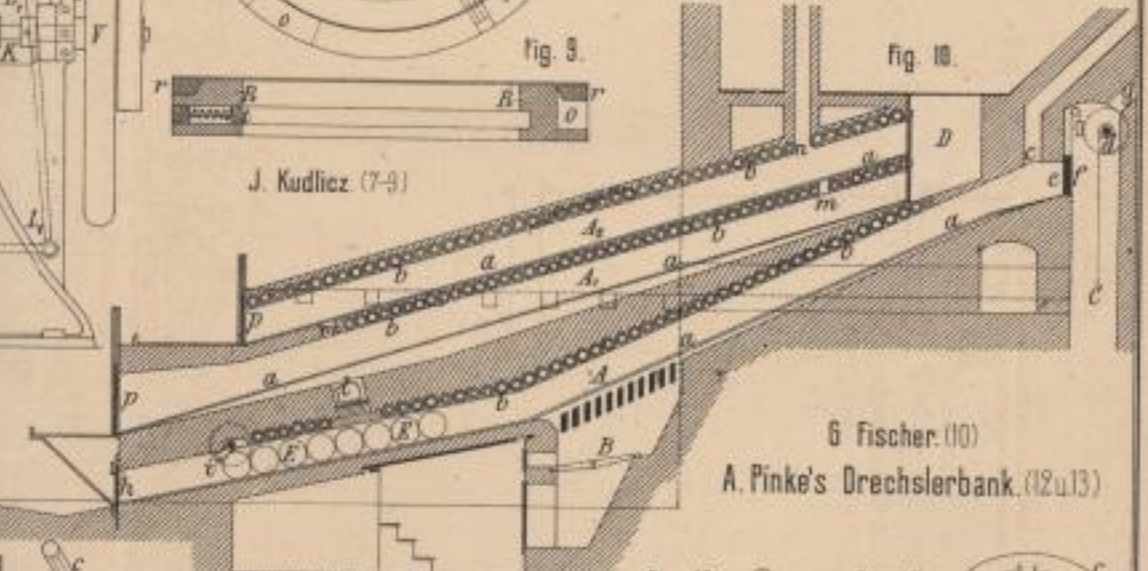

Fig. 10.

G. Fischer. (10)

A. Pinke's Drechslerbank. (12 u. 13)

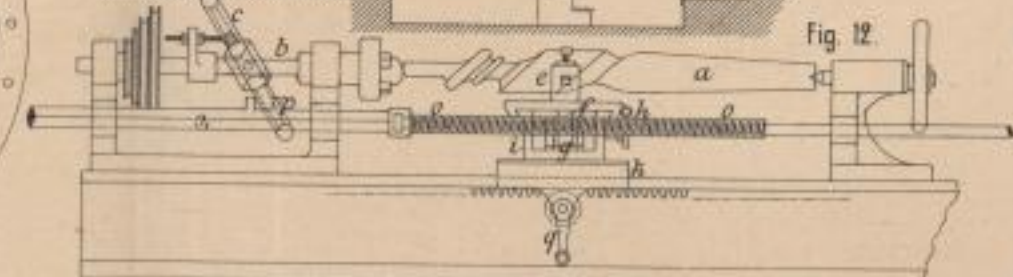

Fig. 12.

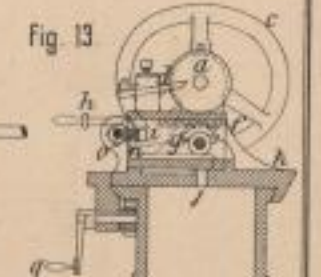
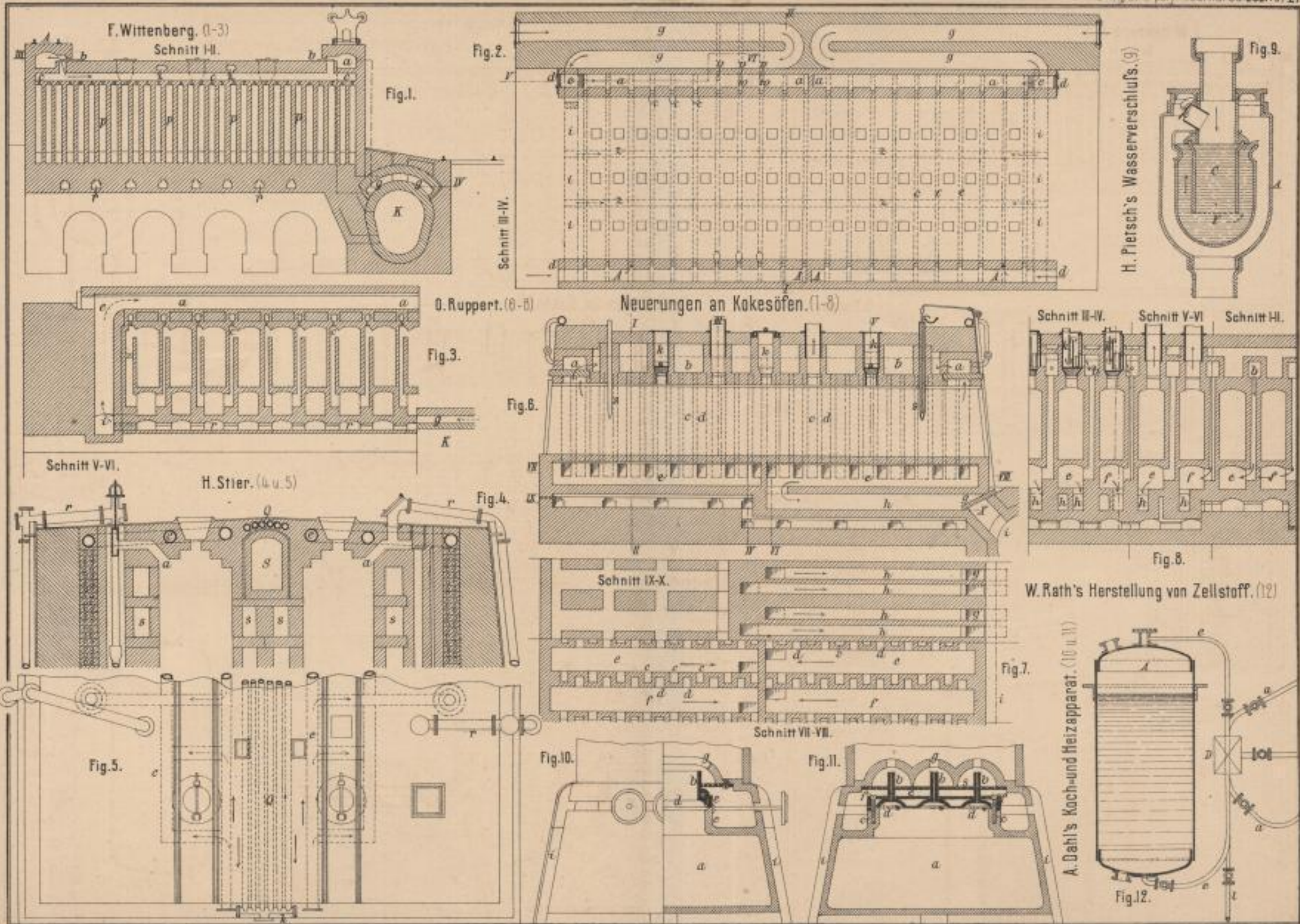

Fig. 13.

Lith. Anst. v. P. Wirtz, Darmstadt.







Lehr. Anst. v. F. Wirtz Darmstadt



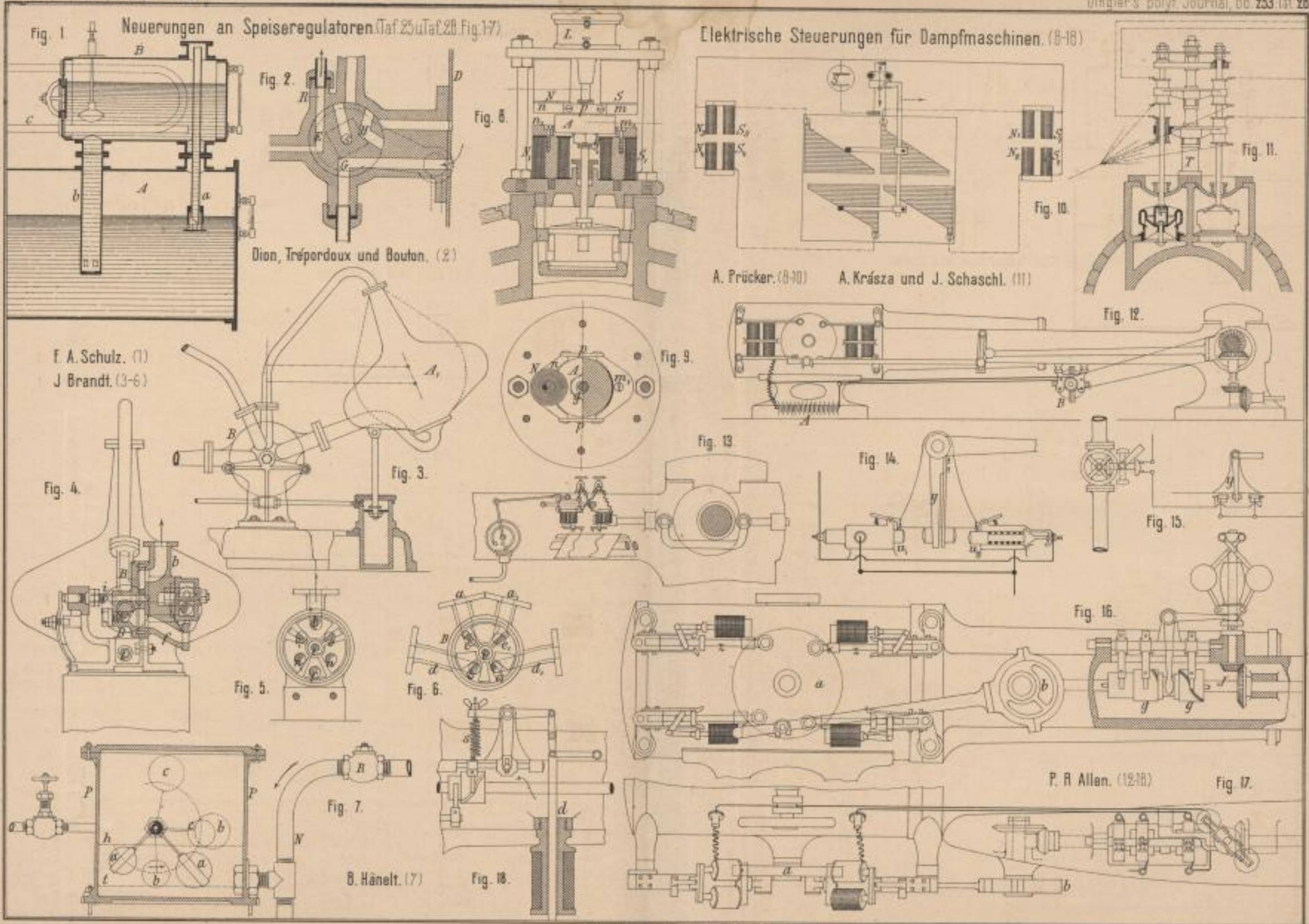

Lith. Anst. v. F. Wörle, Darmstadt.



J. H. Reinhardt's rotirende Presse. (6 u. 7)

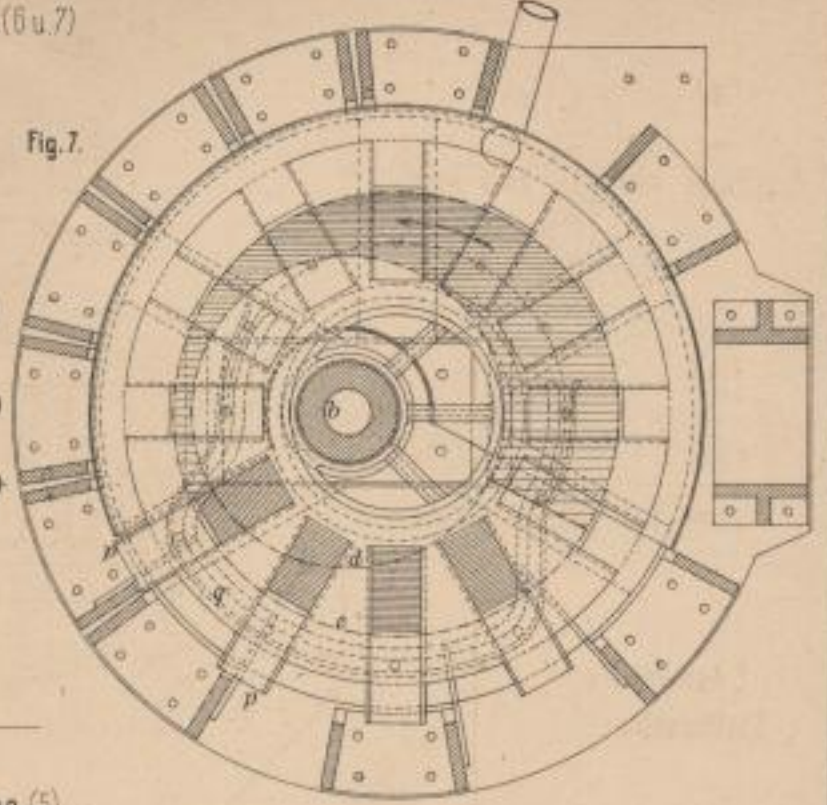
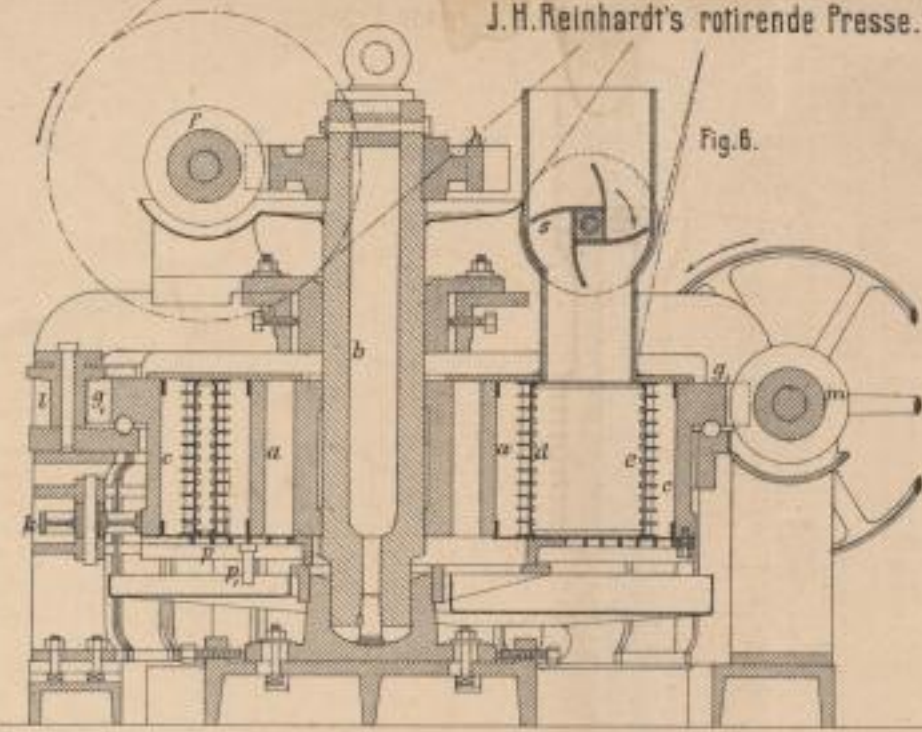
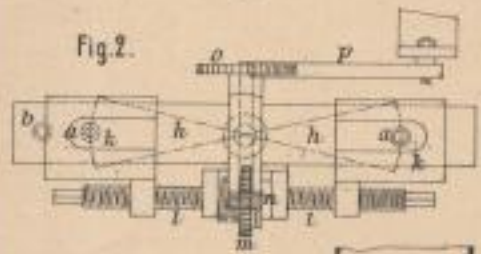
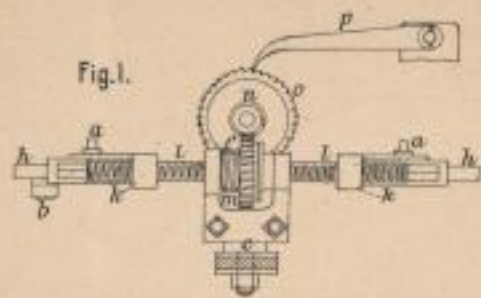

E. Ashworth's Spulmaschine. (1 u. 2)

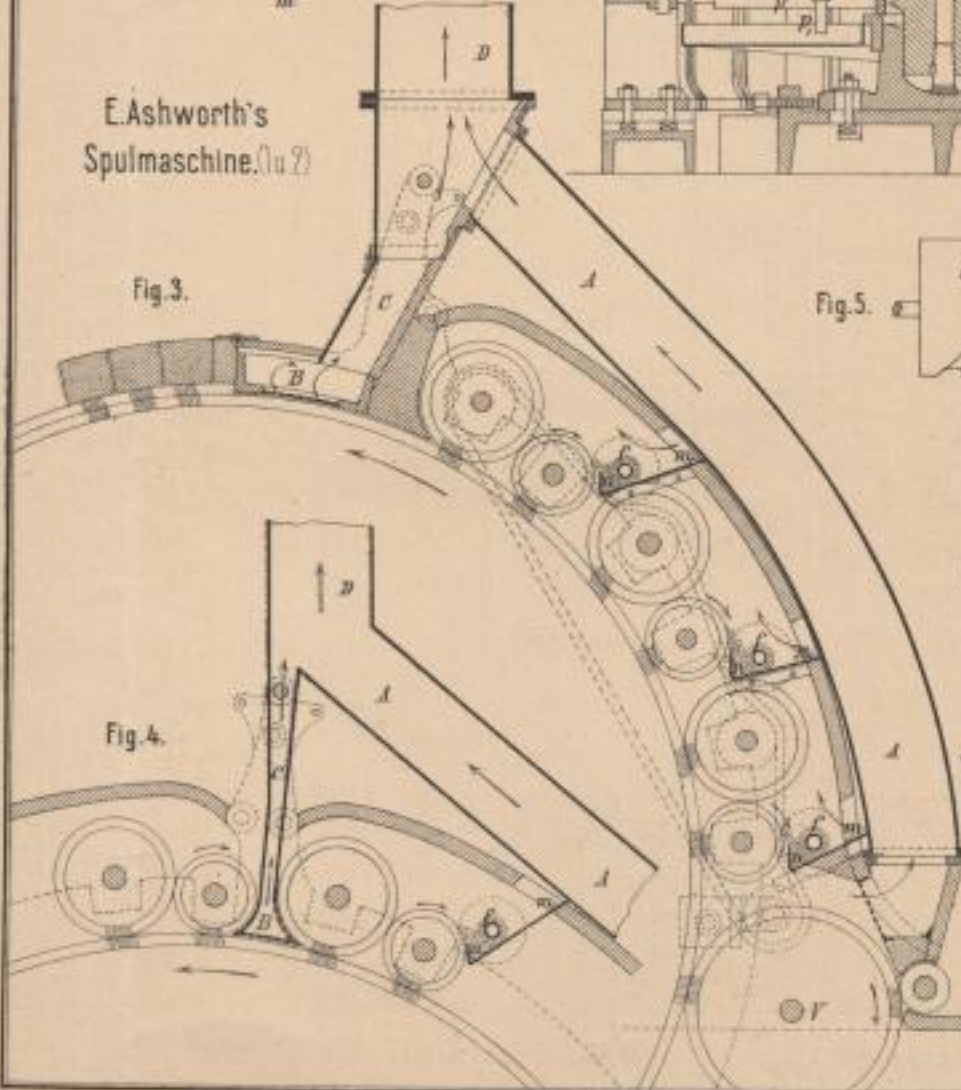

R. Voigt's Spulmaschine. (5)

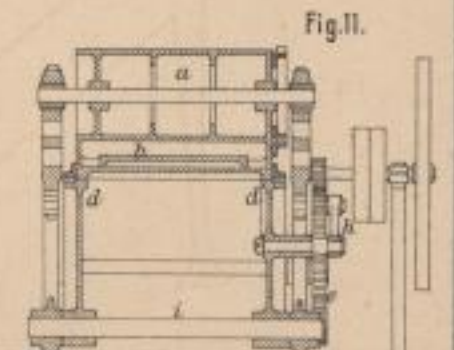
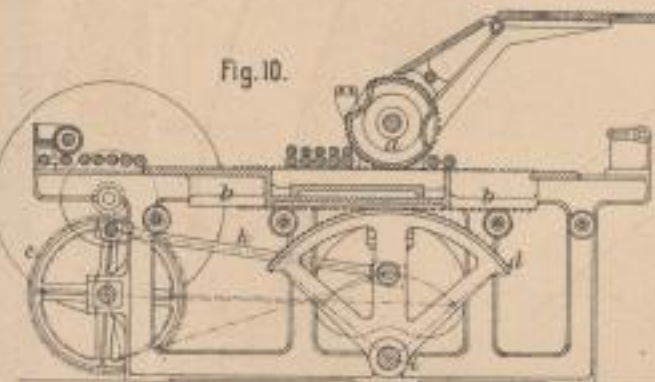
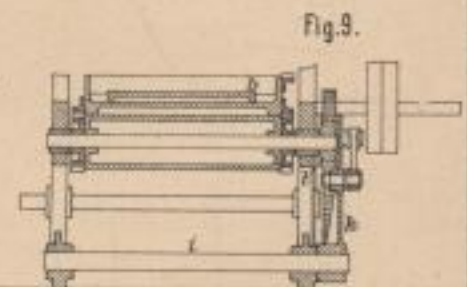
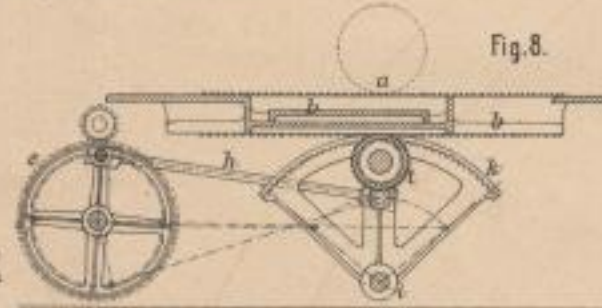
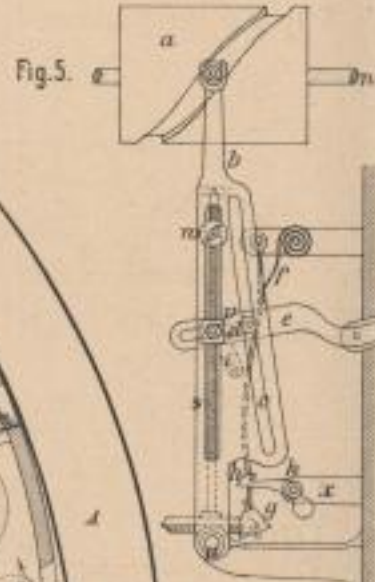

Ten-Brink's Staubabführung bei Krempeln. (3 u. 4)

W. Müller und Kieffs' Schnellpresse. (8-11)

Lith. Anst. F. Wirtz, Darmstadt.





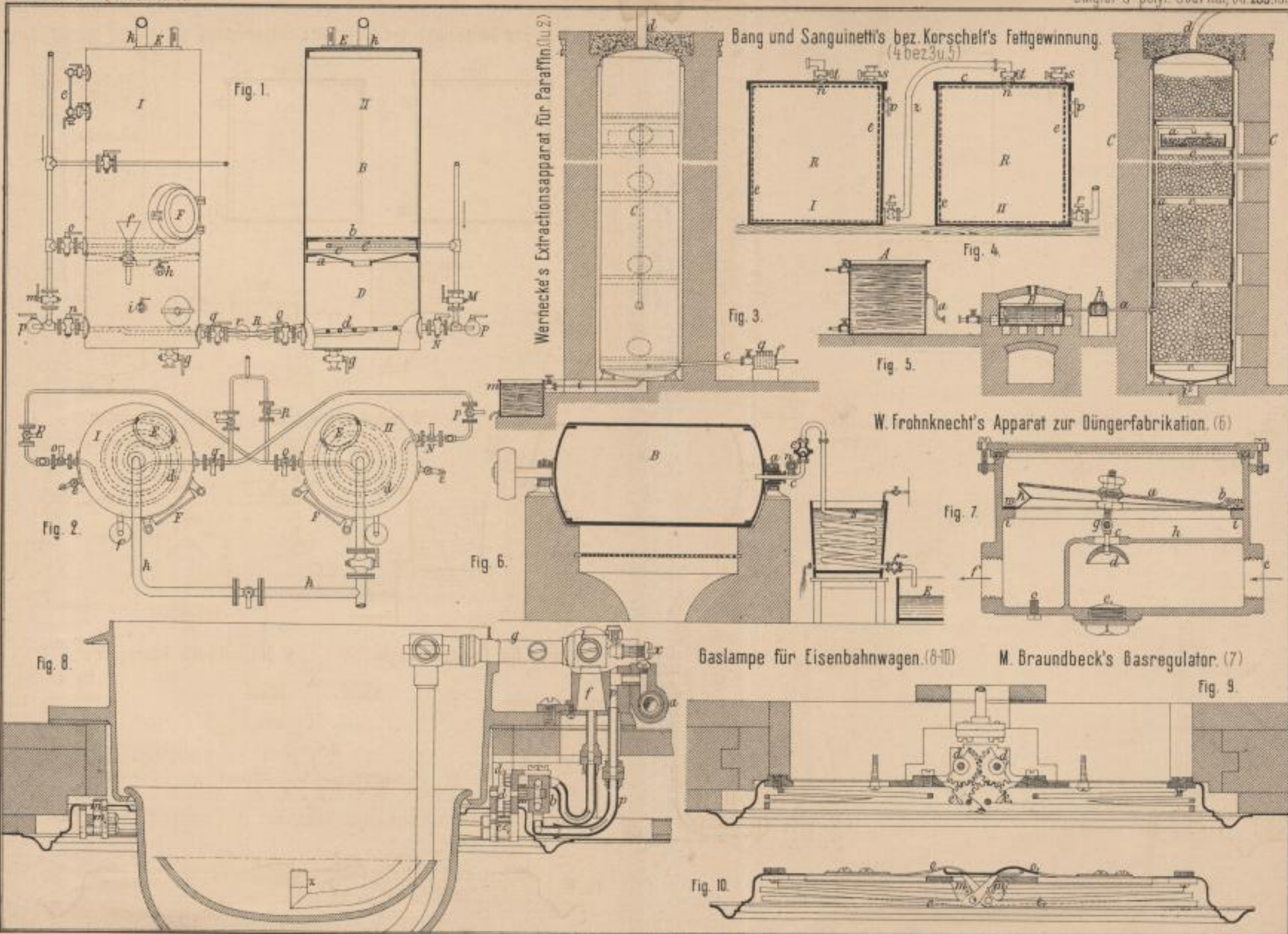

Lith. Anst. v. F. Wirtz, Darmstadt.



Moscrop-Williams' Geschwindigkeits-Registrierapparat. (1-4)

W. Schmidt's Doppelschieber-Steuerung. (5u.6)

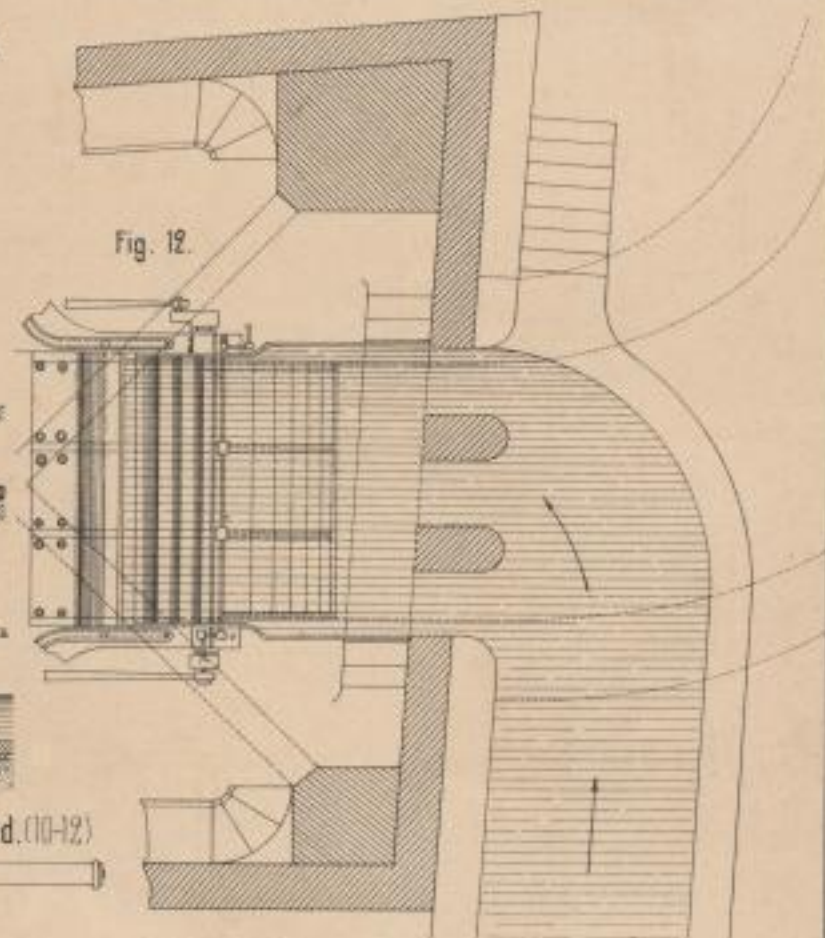
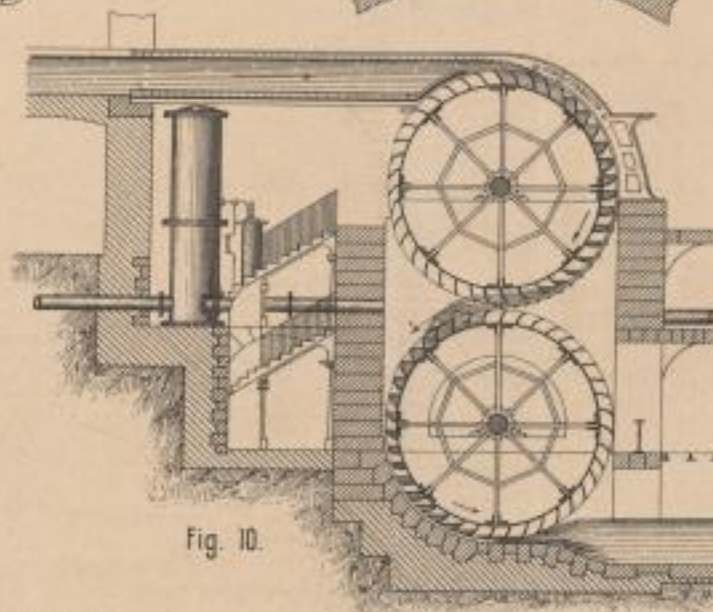
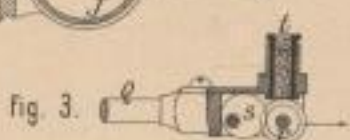
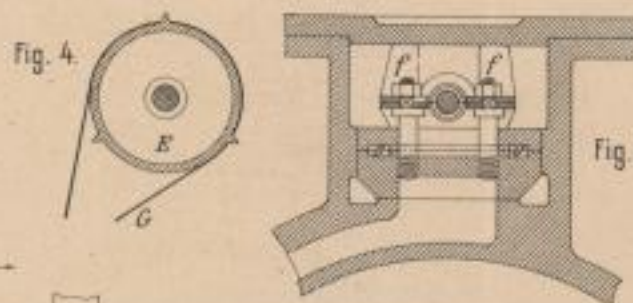
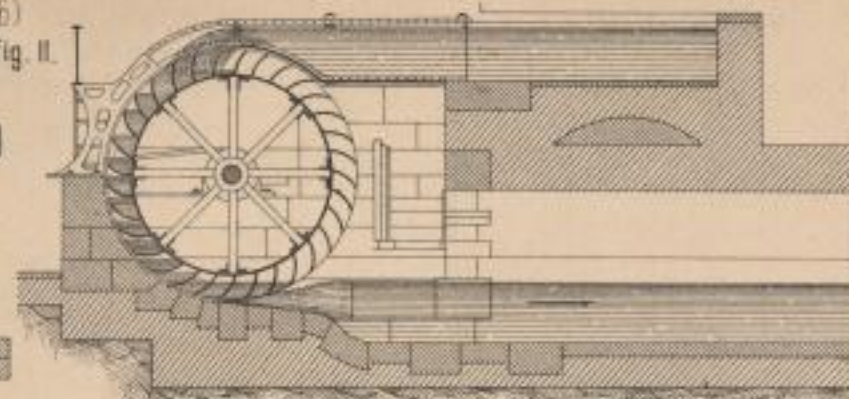
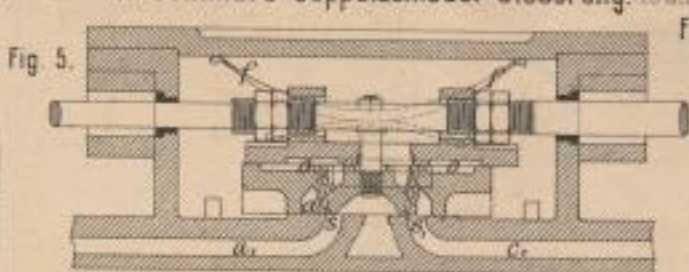
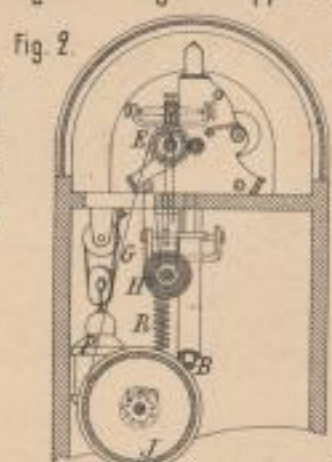
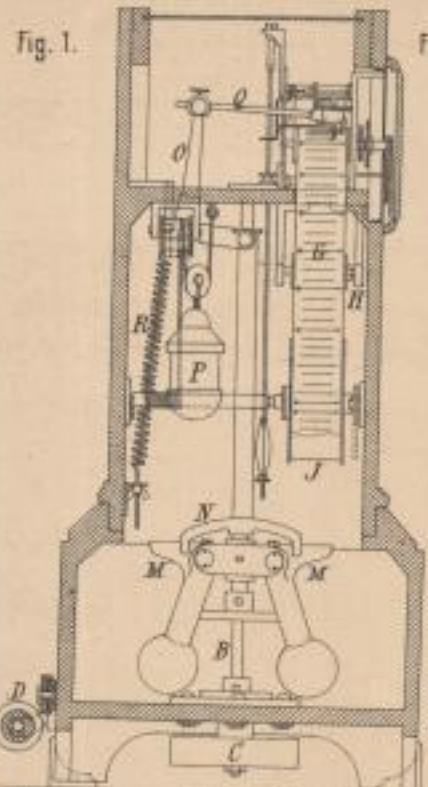

Westinghouse's bez. Willan's elektrischer Regulator. (7u.8bez9)

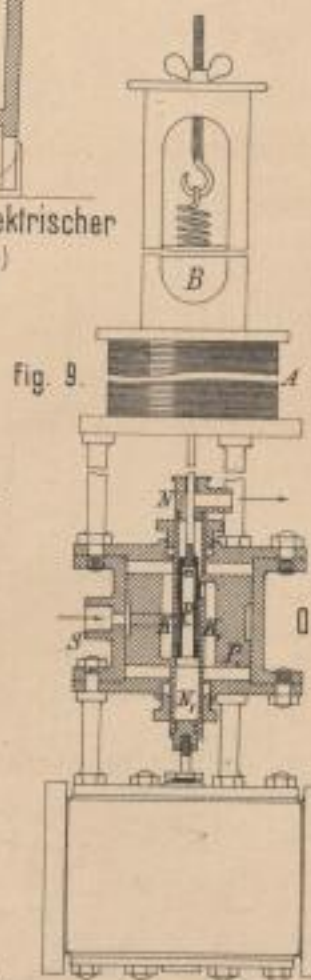
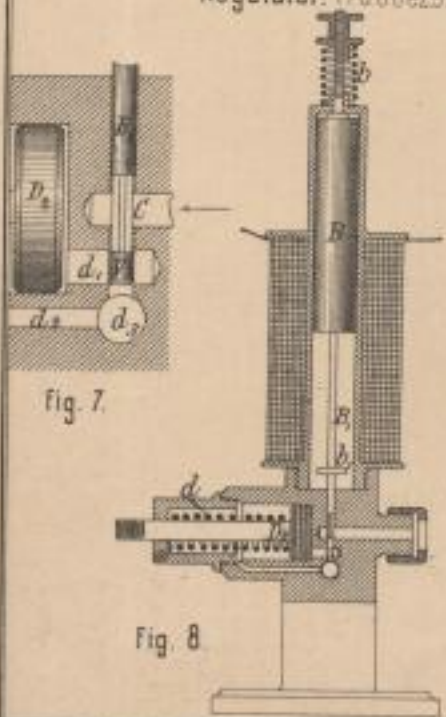

O. Zobel's Bremskurbel. (13u.14)

Duponchel's Wasserrad. (10-12)

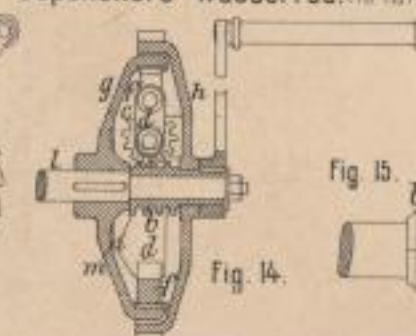
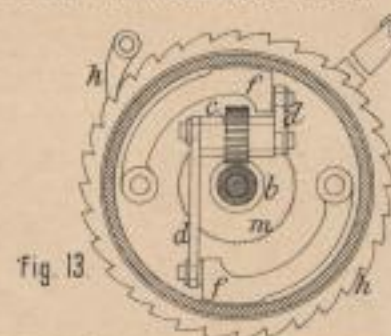

Golden's Kegelschalenkuppelung. (15u.16)

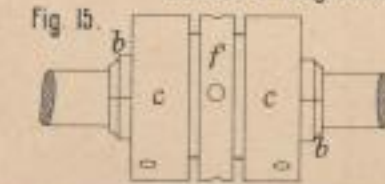

Lith. Anat. v. F. Wirtz, Darmstadt.



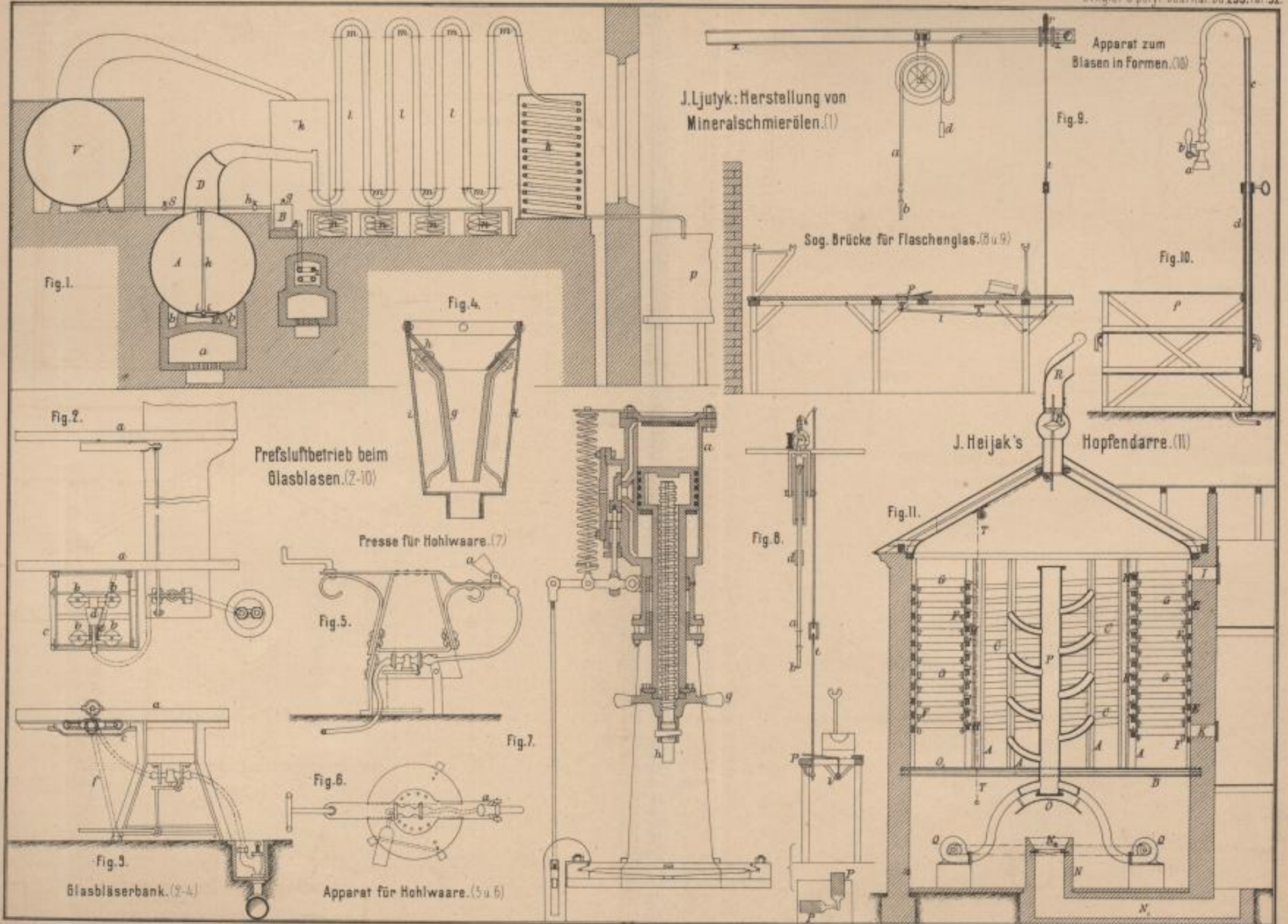

J. Ljutyk: Herstellung von Mineralschmierölen. (1)

Apparat zum Blasen in Formen. (10)

Sog. Brücke für Flaschenglas. (8 u. 9)

Prefsluftbetrieb beim Glasblasen. (2-10)

Presse für Hohlwaare. (7)

J. Heijak's Hopfendarre. (11)

Glasbläserbank. (2-4)

Apparat für Hohlwaare. (5 u. 6)

Lith. Anst. v. F. Wirtz. Darmstadt



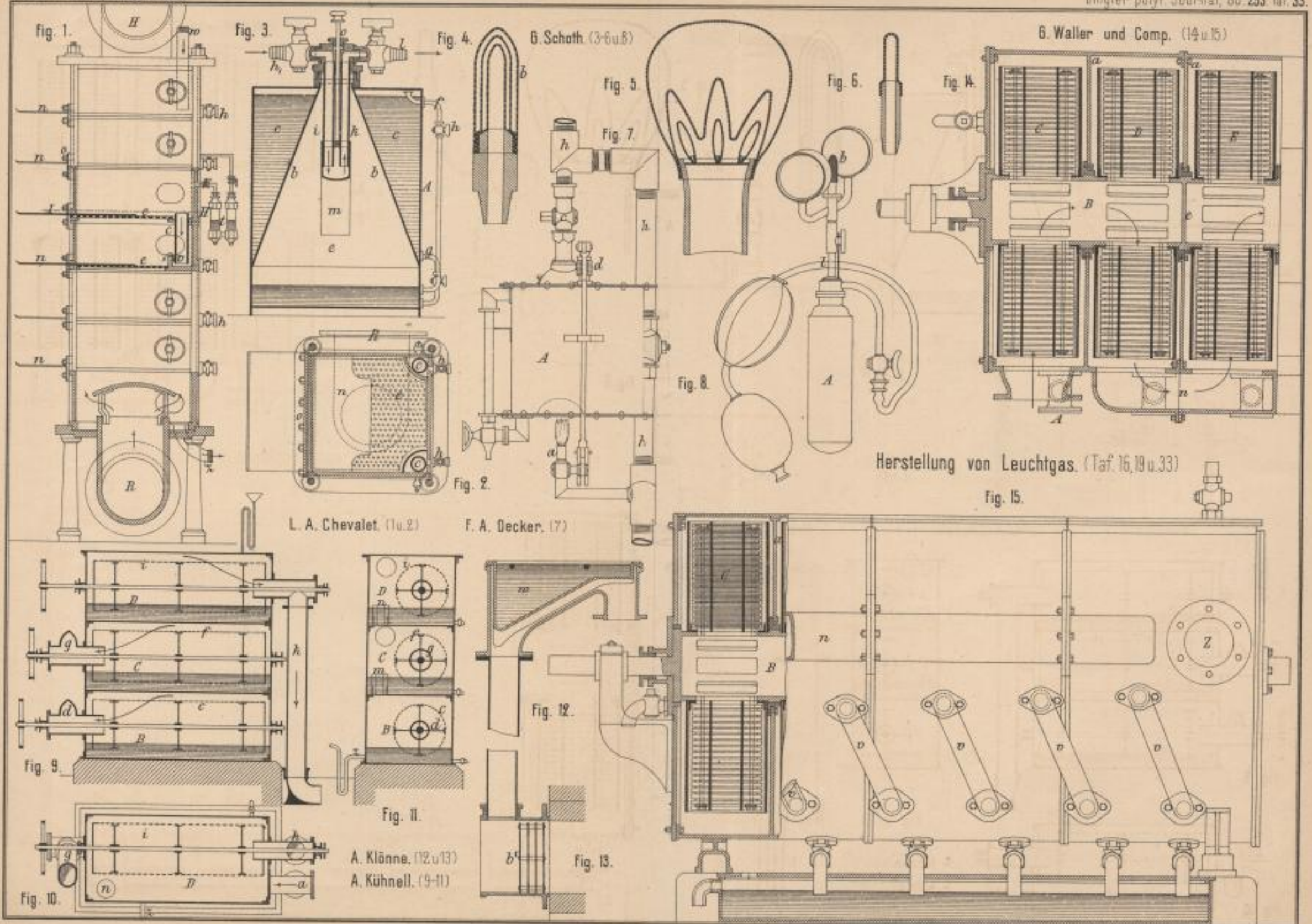

Lith. Anst. v. F. Wirtz, Darmstadt.



Neuerungen an dynamo- und magneto-elektrischen Maschinen. (Taf. 34)

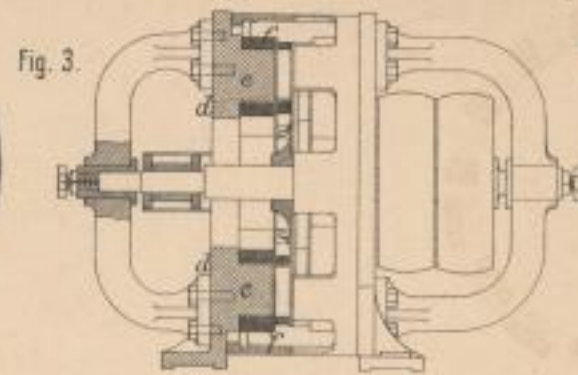
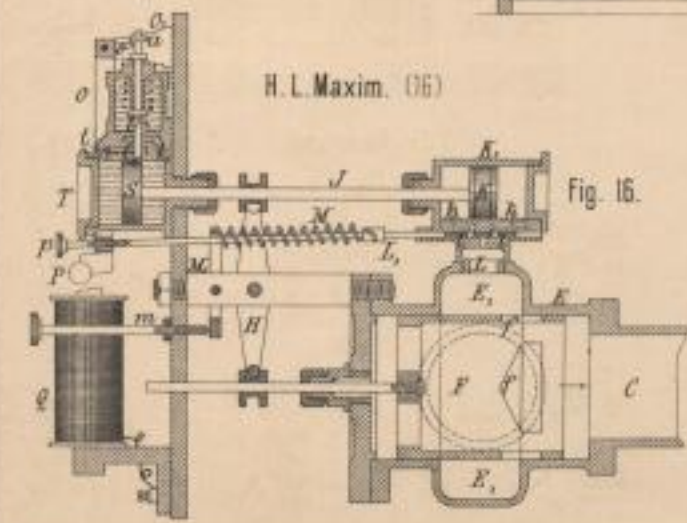
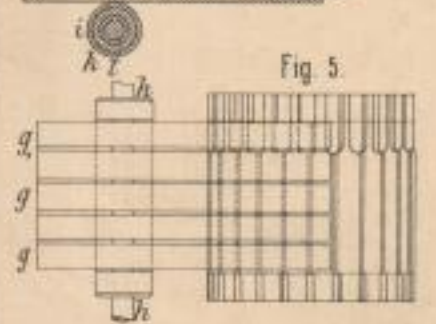
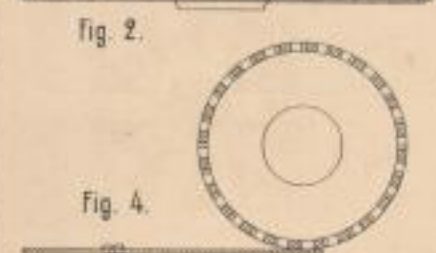
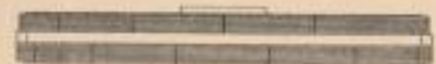
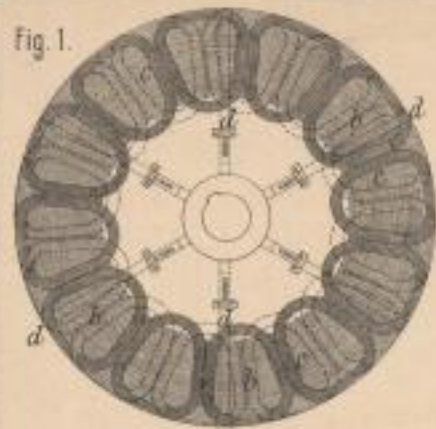

Hopkinson und Muirhead. (1-5)

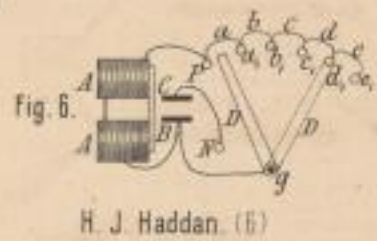

H. J. Haddan. (6)

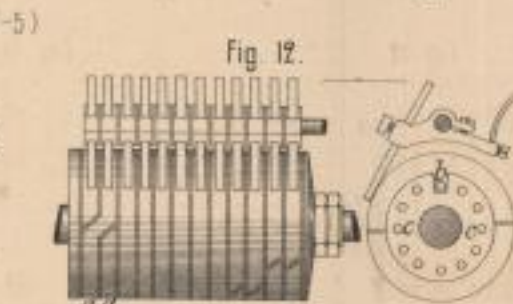
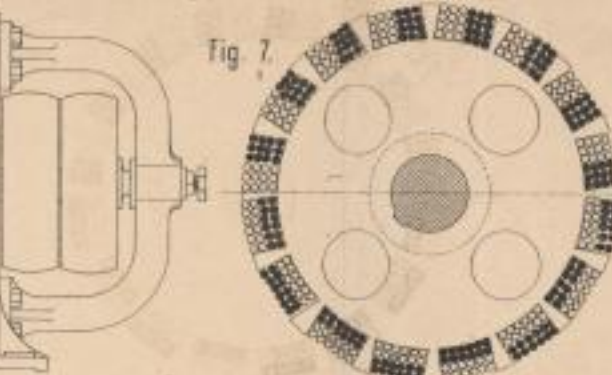
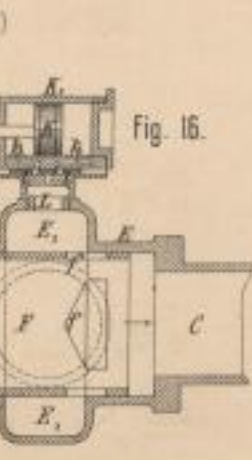
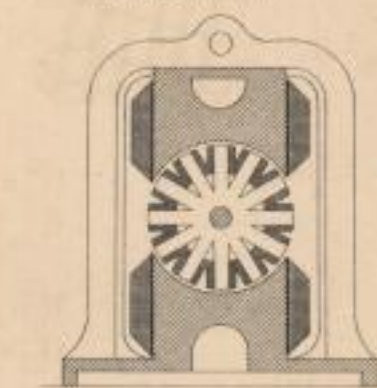

J. D. F. Andrews. (11-15)



F. J. Plücker. (18)

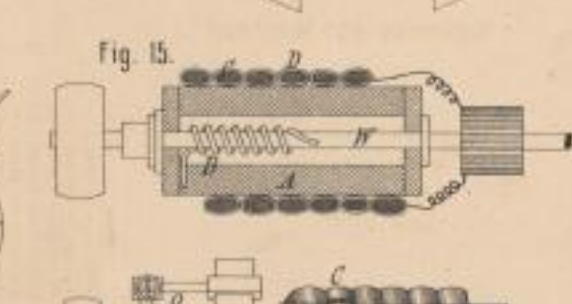
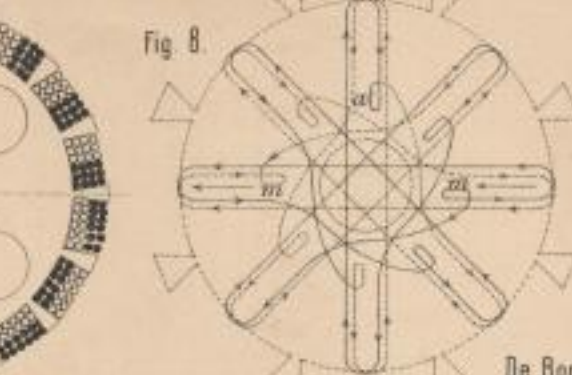
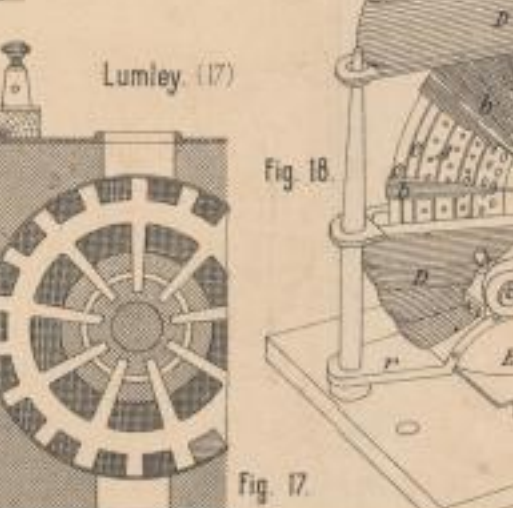

R. Etienne. (19)



F. J. Plücker. (18)

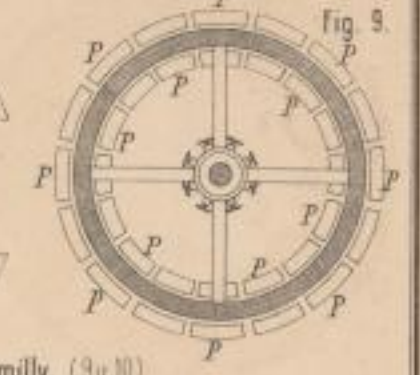
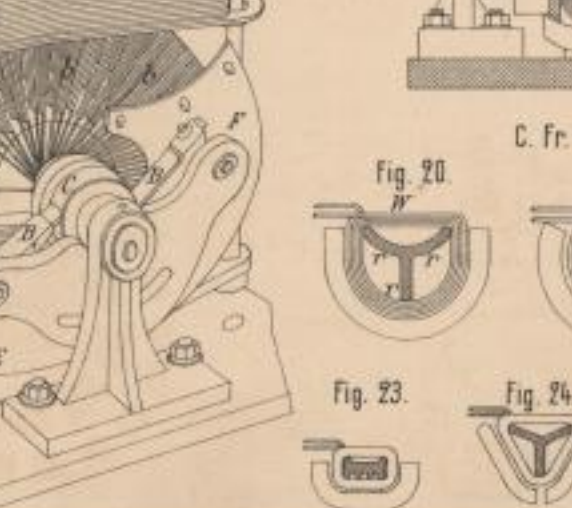

De Romilly. (9 u. 10)

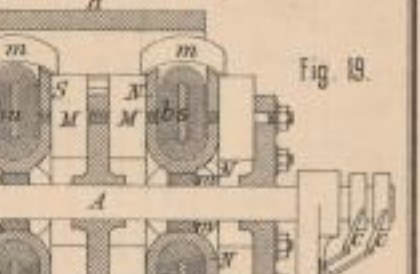

C. Fr. Heinrichs. (20-26)

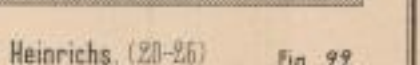

Lith. Anst. v. F. Wirtz, Darmstadt.



Verarbeitung der Melasse nach Steffen's Ausscheidungsverfahren (1-6)

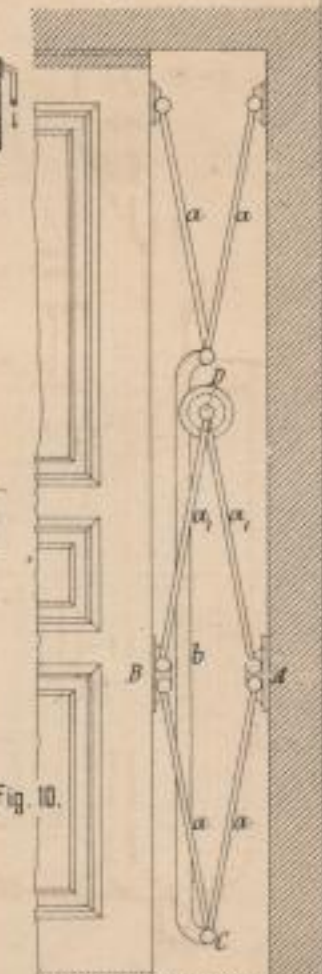
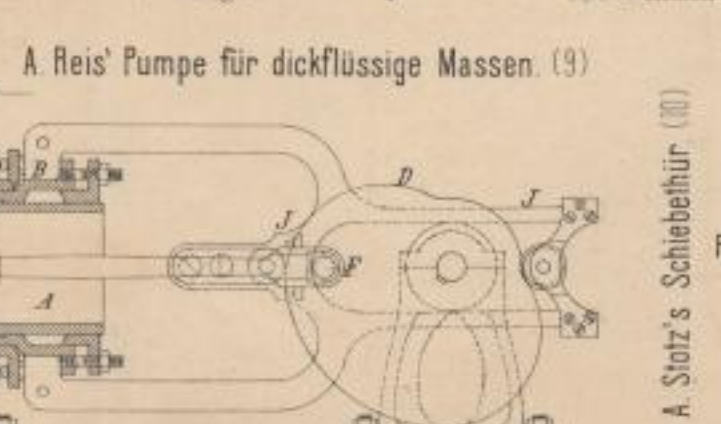
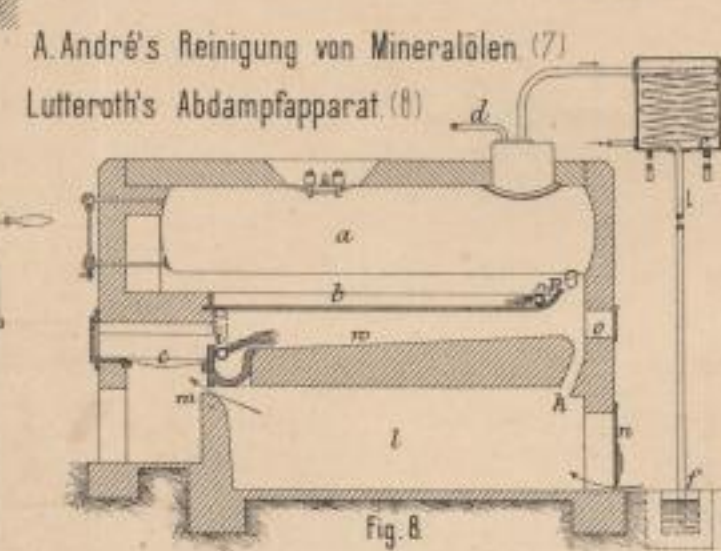
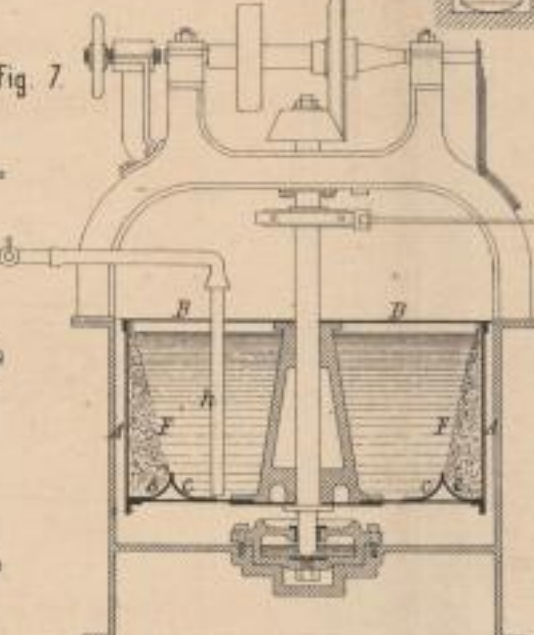
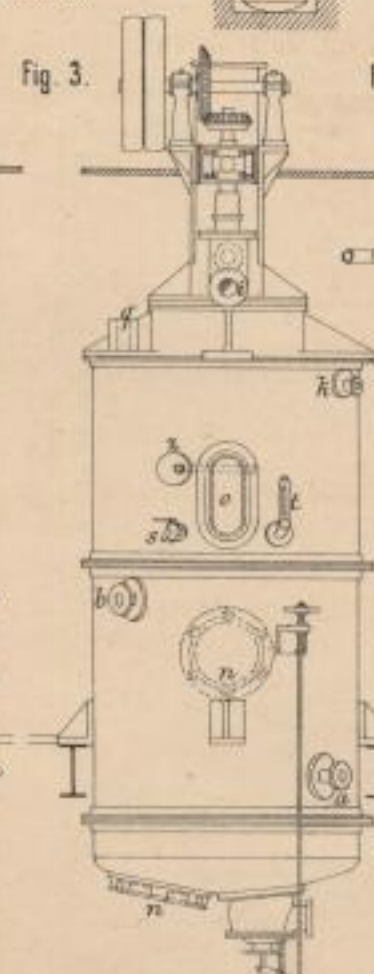
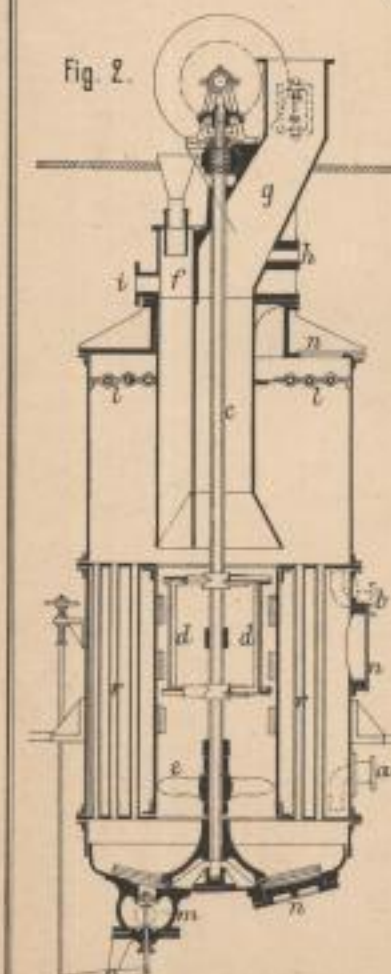
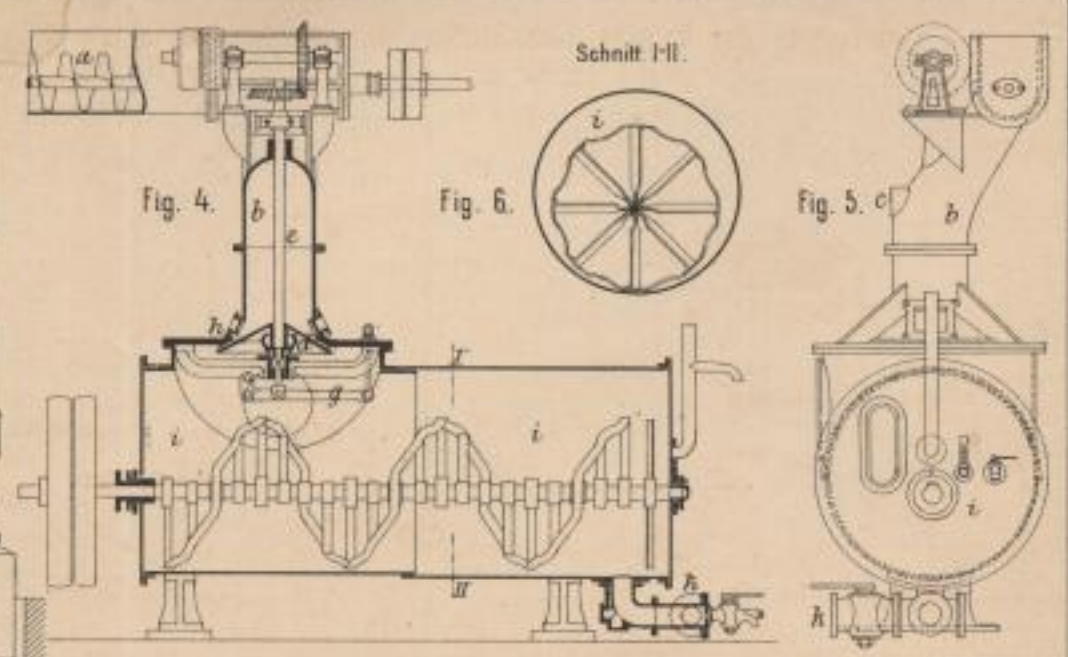
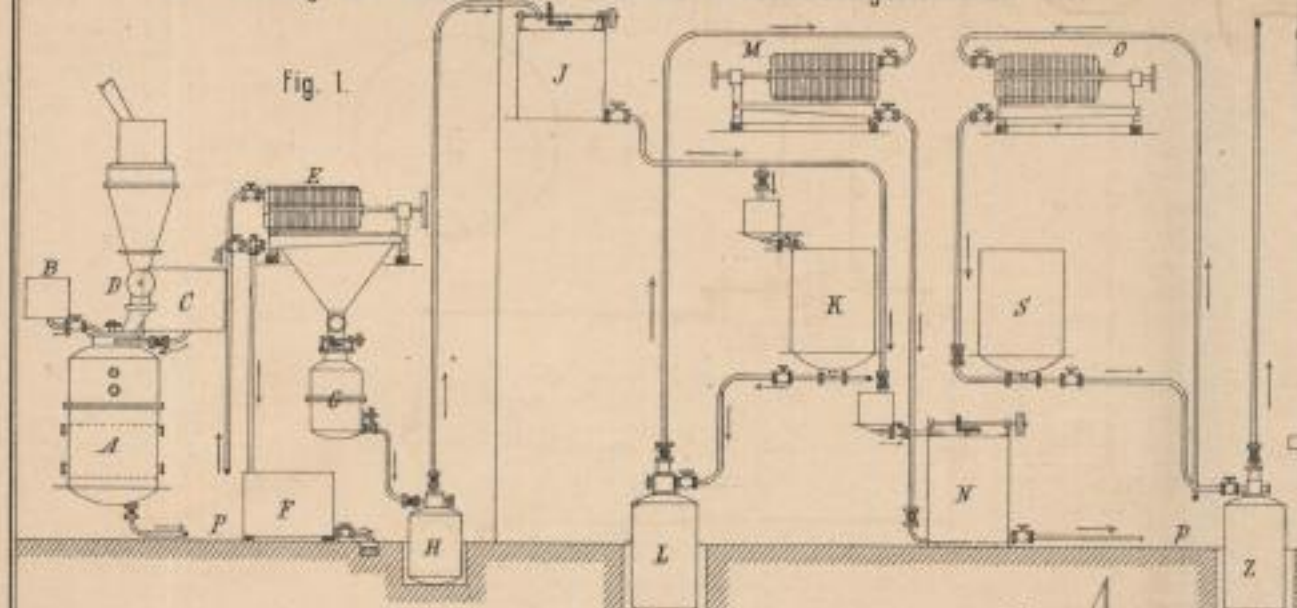

Lith. Anst. v. F. Wirtz, Darmstadt.



Neuerungen im Hüttenwesen. (Taf. 37).

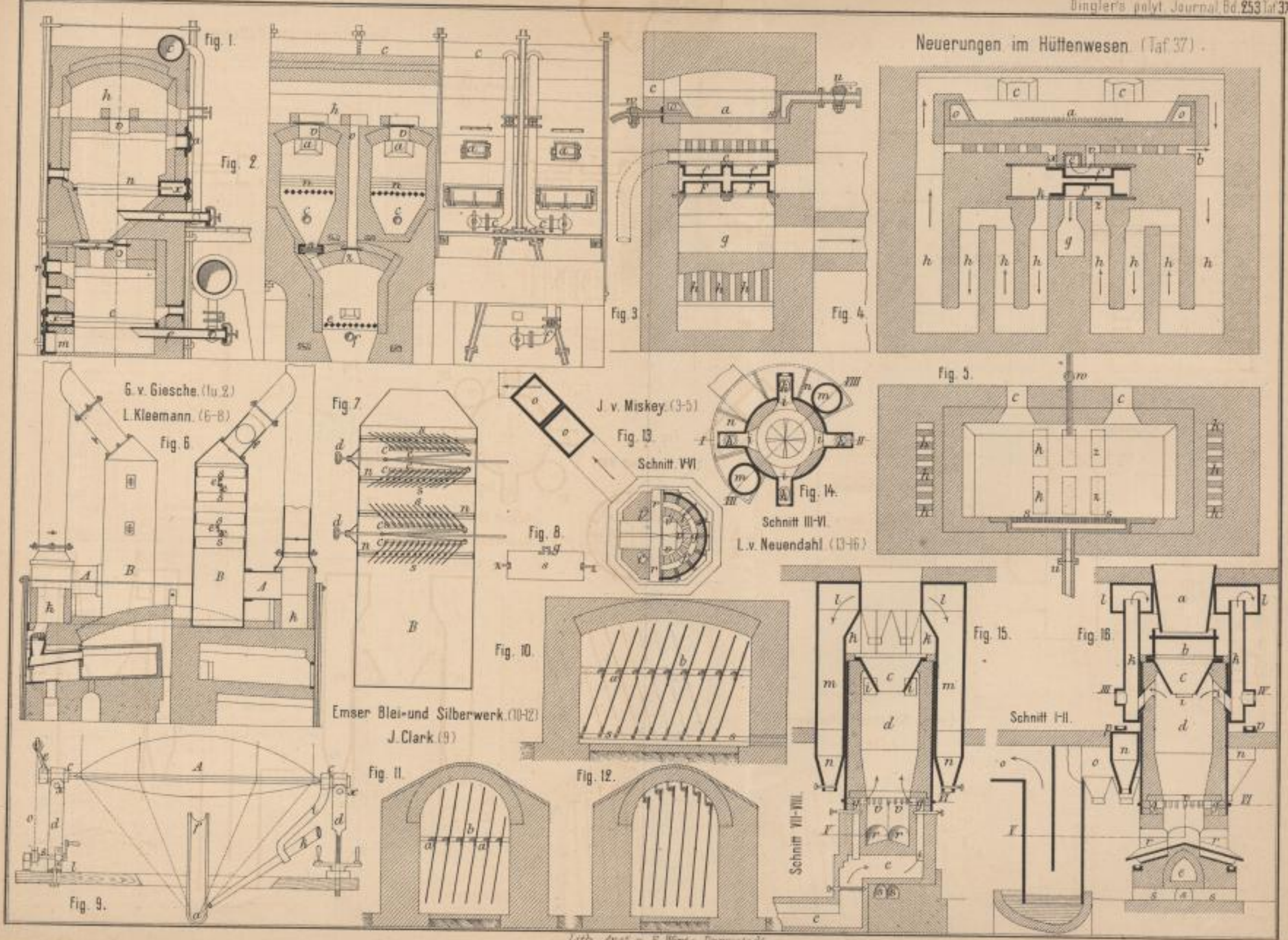

Lith. Anat. v. F. Wirtz, Darmstadt.



















SLUB DRESDEN



3 2422825