









1853

Journal





# Atlas

zu

## Dingler's polytechnischem Journal.

Band 250.

(Vierundsechzigster Jahrgang.)

Jahrgang 1883.

---

Enthaltend 38 lithographirte Tafeln.



Stuttgart.

Verlag der J. G. COTTA'schen Buchhandlung.

05356

Alia

Journal

Band 260

(Hundertachtzigster Jahrgang)

Jahrgang 1881

Verlag von C. Neumann, Neudamm



Sächsische  
Landesbibliothek  
Dresden

Verlag von C. Neumann, Neudamm

1881





Sächs.  
Landesbibl.  
Dresd.

# Neuerungen an Dampfpumpensteuerungen. (Taf. 1 u. 5)

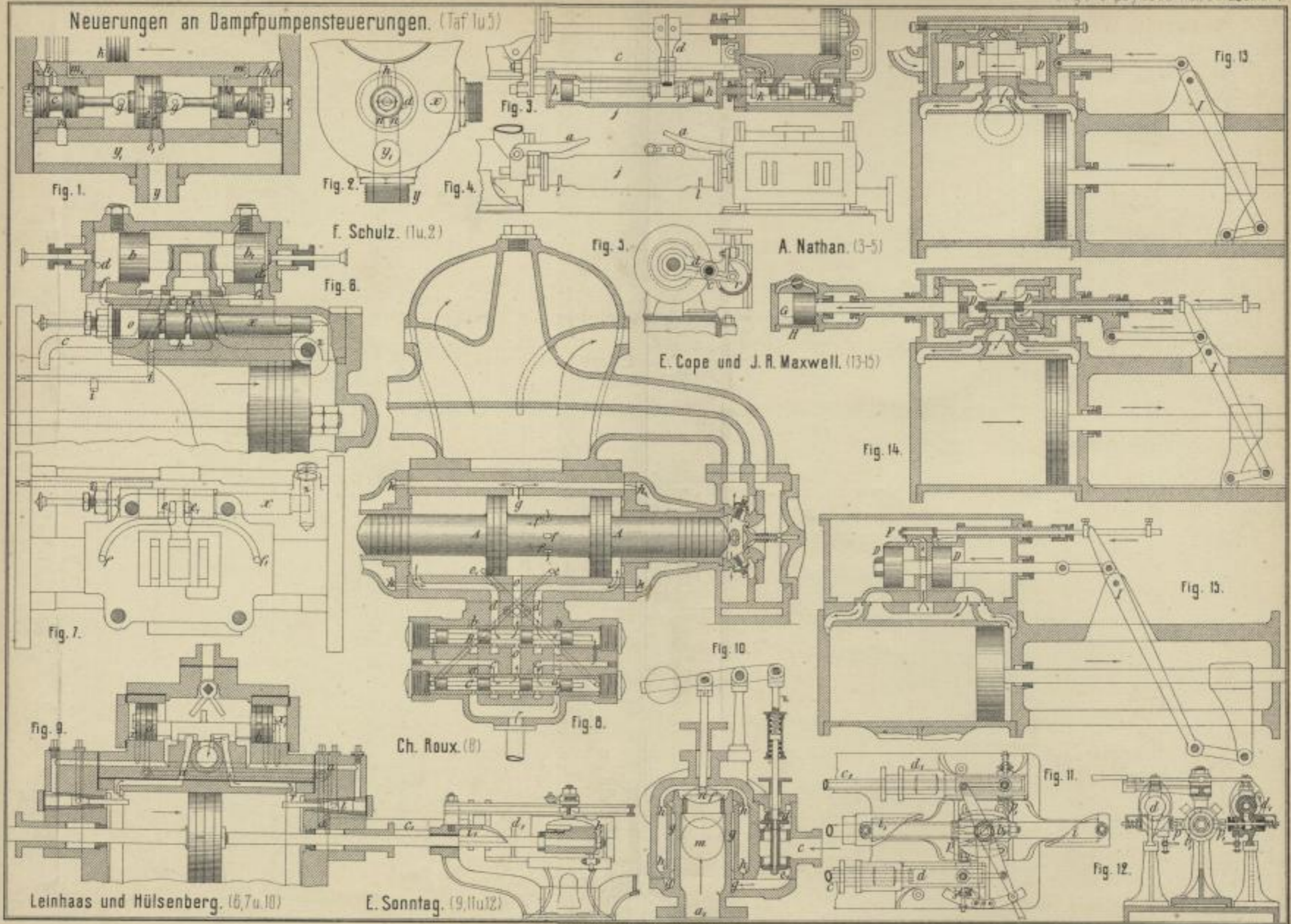

Fig. 1.

Fig. 2.

Fig. 4.

Fig. 3.

Fig. 13.

F. Schulz. (1 u. 2)

A. Nathan. (3-5)

Fig. 6.

Fig. 5.

E. Cope und J. R. Maxwell. (13-15)

Fig. 14.

Fig. 7.

Fig. 15.

Fig. 9.

Ch. Roux. (8)

Fig. 10.

Fig. 8.

Leinhaas und Hülsenberg. (6, 7 u. 10)

E. Sonntag. (9, 11 u. 12)

Fig. 12.

Lith. Anst. v. F. Wirtz, Darmstadt.



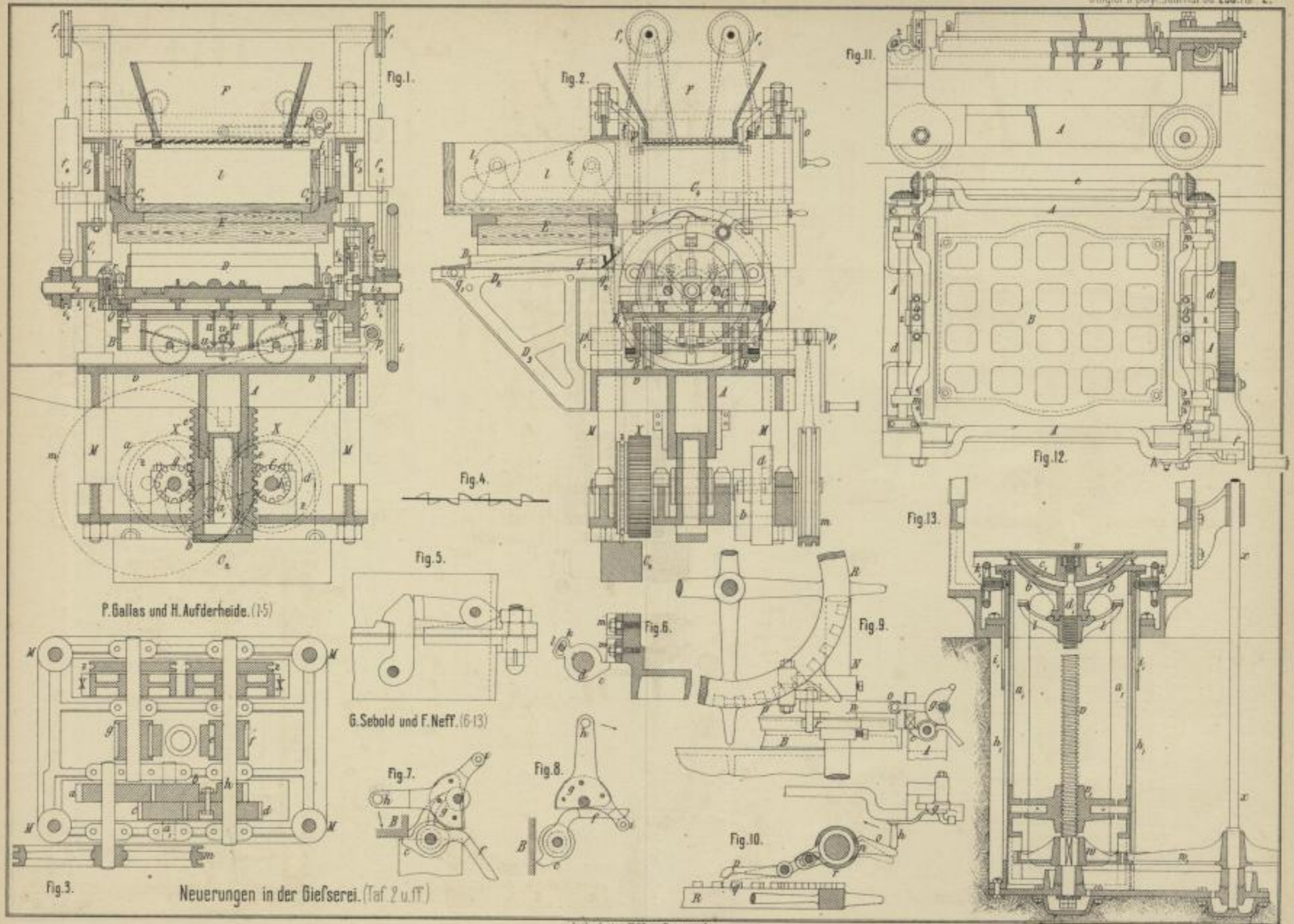

P. Gallas und H. Aufderheide. (1-5)

G. Sebold und F. Neff. (6-13)

Neuerungen in der Gießerei. (Taf. 2 u. ff.)

Lith. Anst. v. F. W. v. Zornmünde

Neuere Apparate für Zuckerfabriken. (1-15)

Fig. 2. Waschmaschinen für Rüben und Kartoffeln. (1-8.)

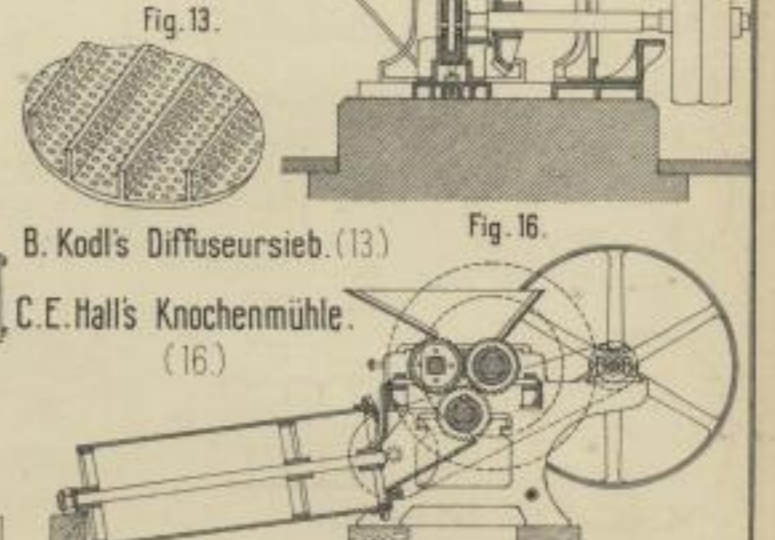
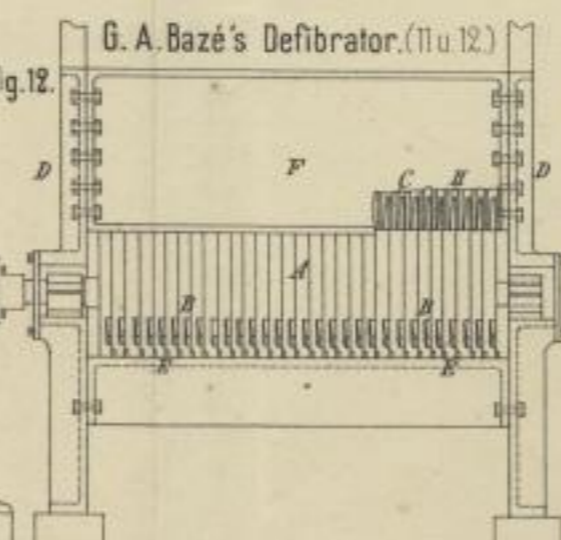
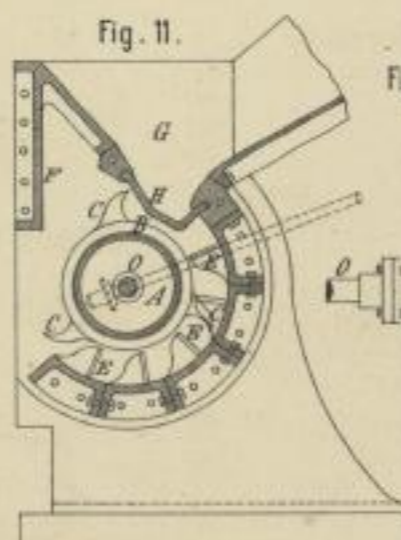
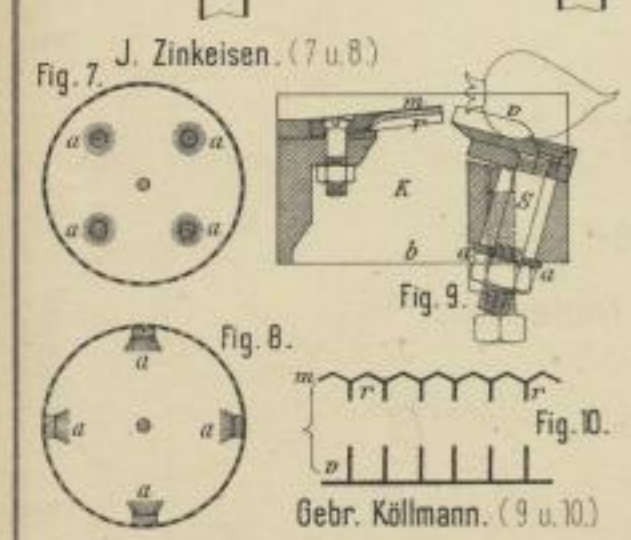
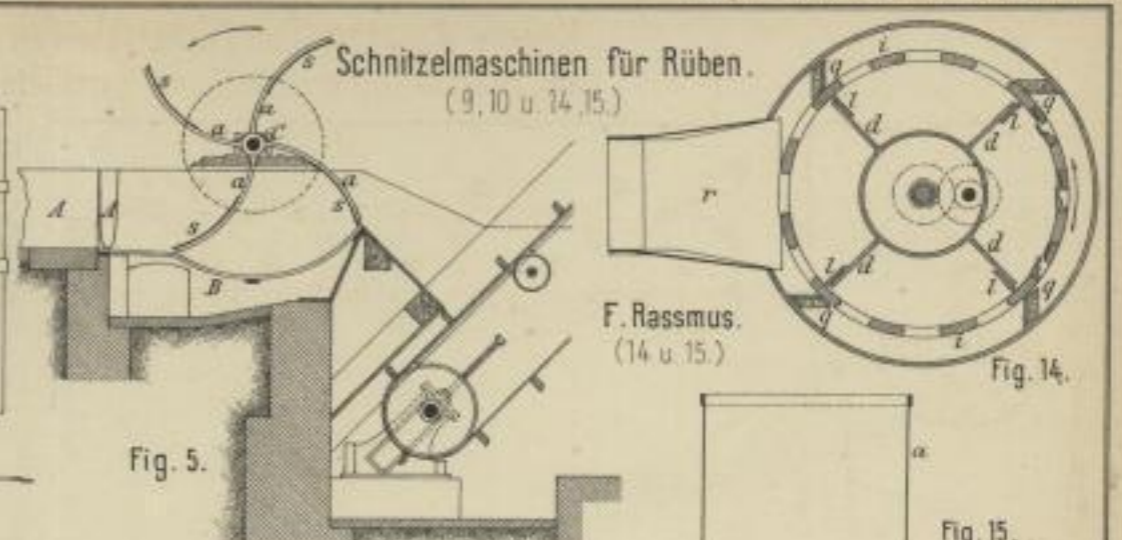
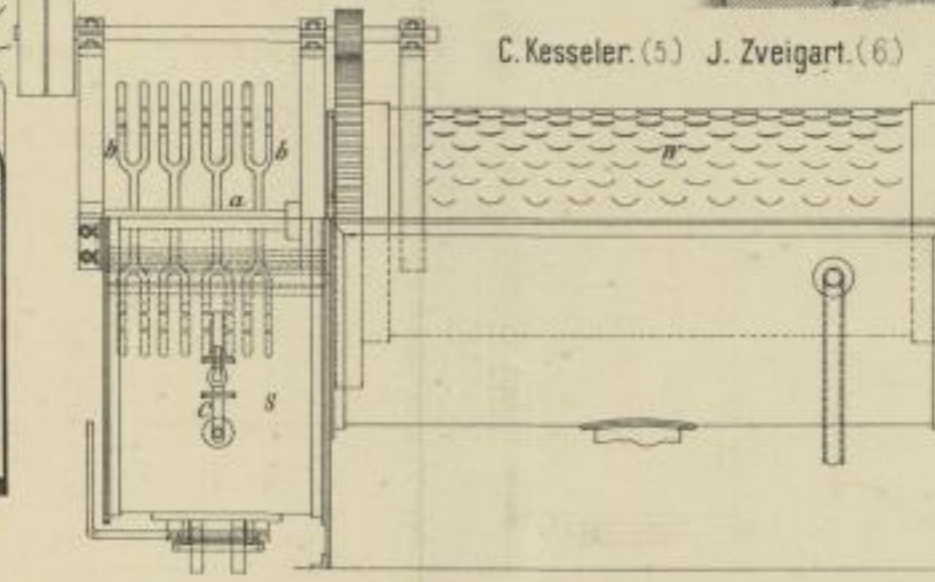
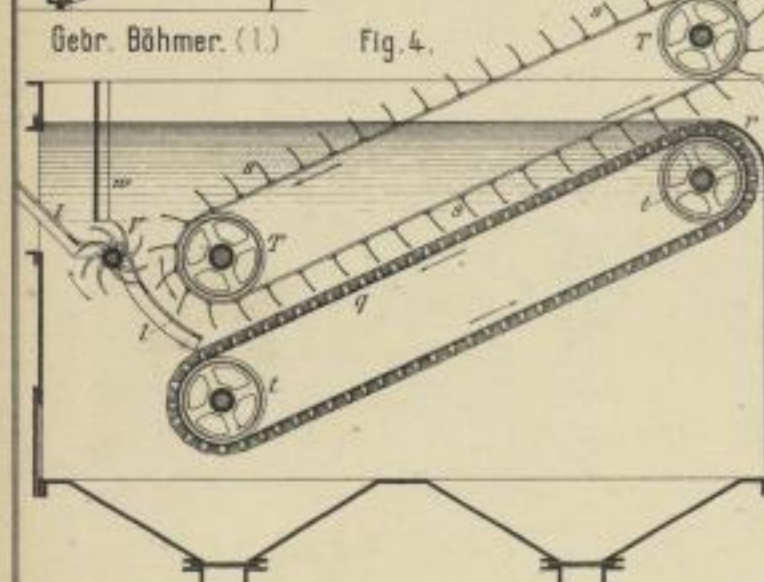
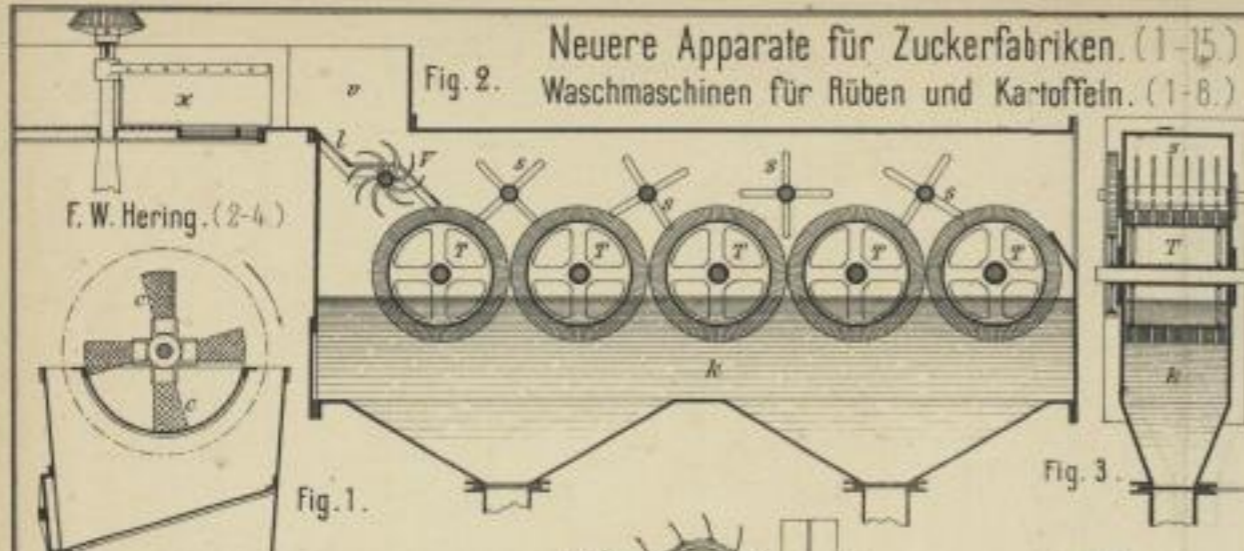

100. Ausg. v. F. Wirtz, Darmstadt.

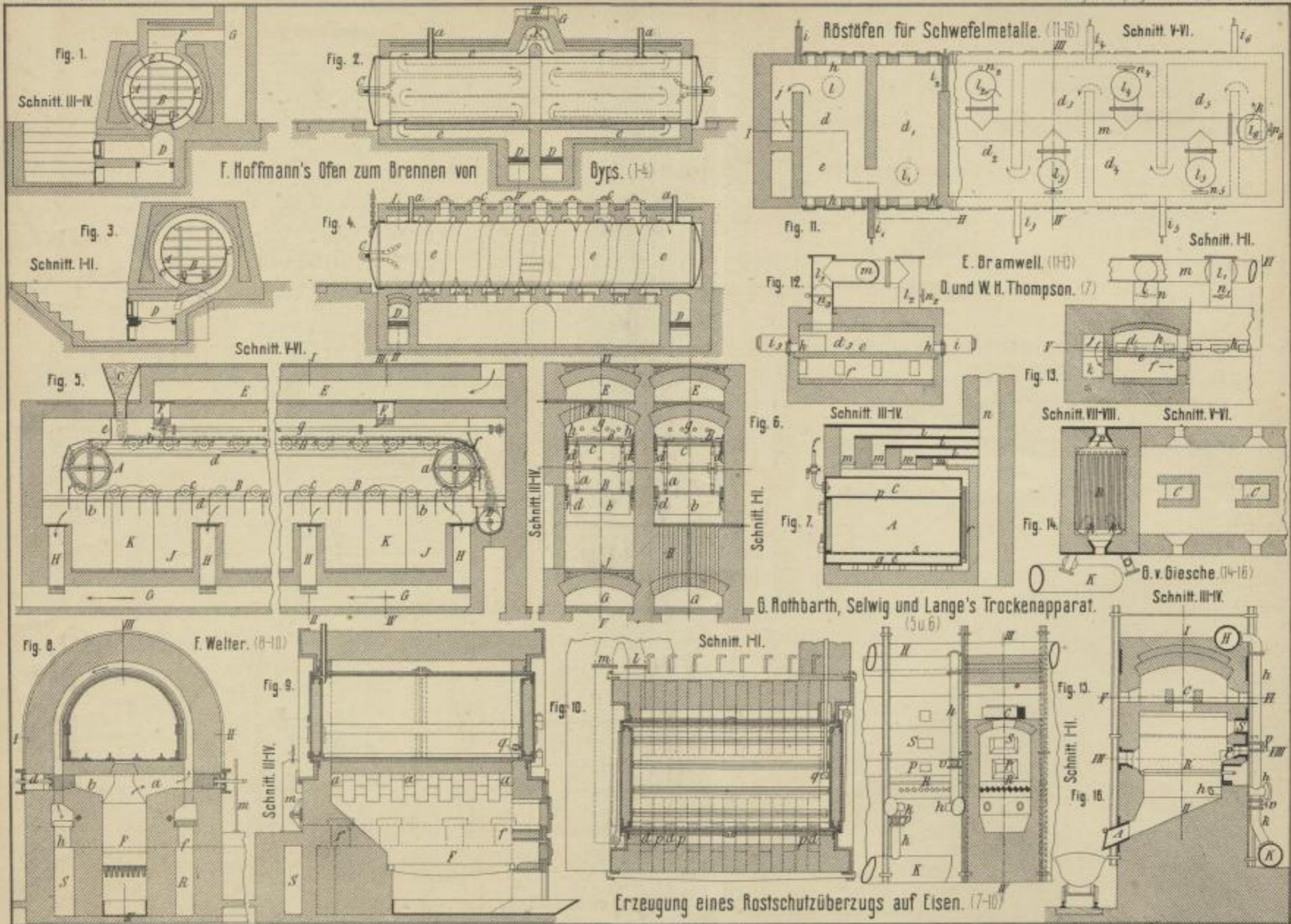

Lith. Anst. v. F. Wirtz, Darmstadt.

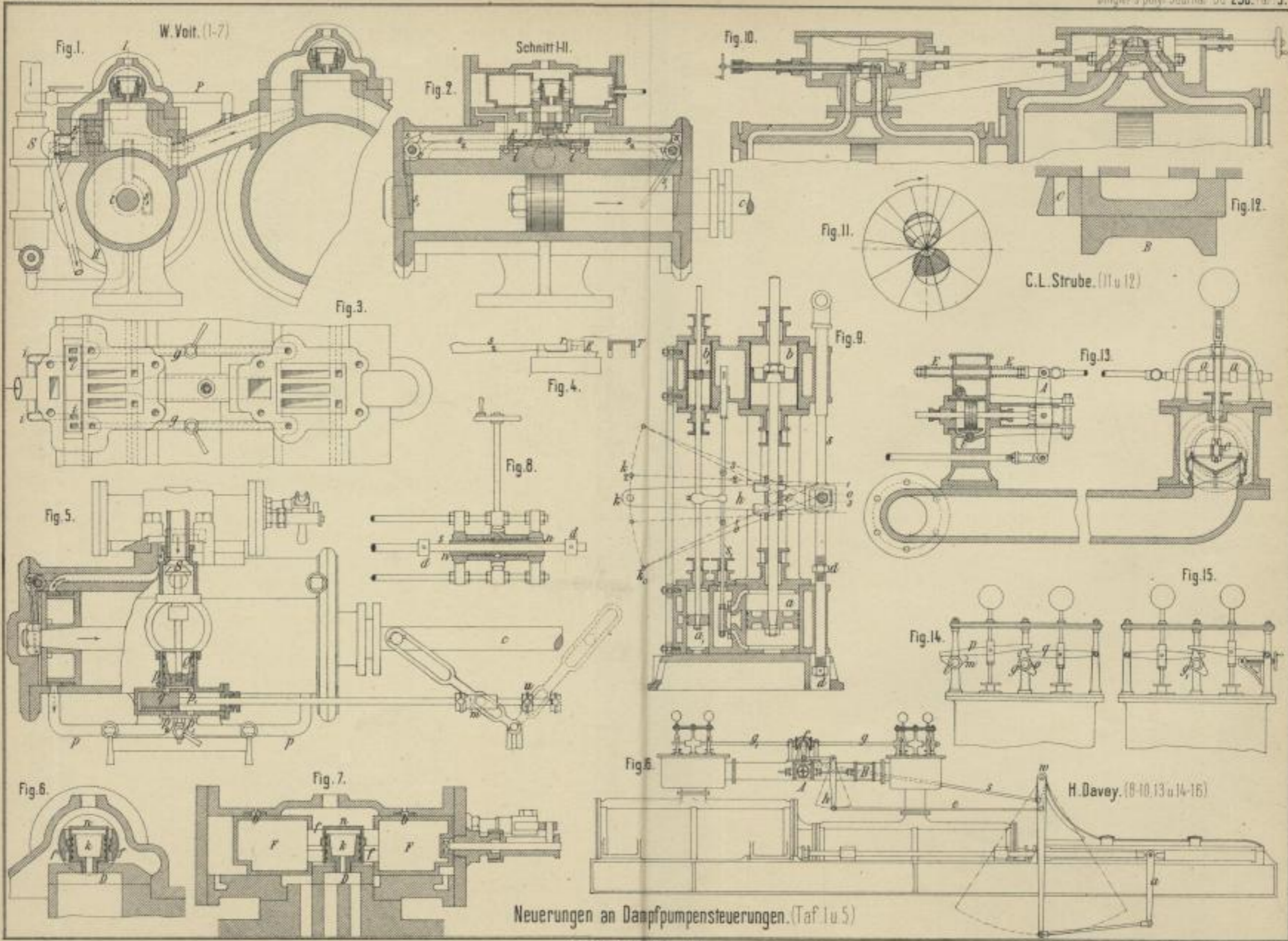

Neuerungen an Dampfmaschinensteuerungen. (Taf. 1 u 5)

Lith. Anst. v. F. Bött. Darmstadt

Schutzvorrichtungen für Kreissägen. (1-5)

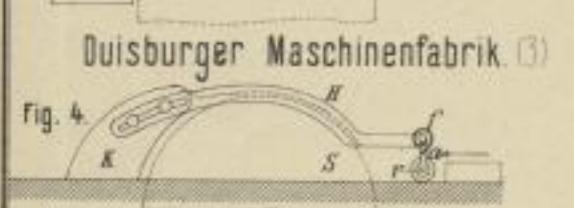
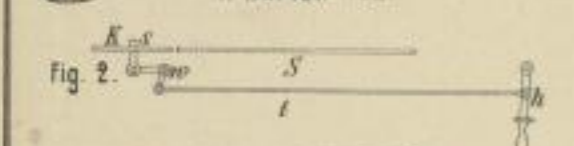
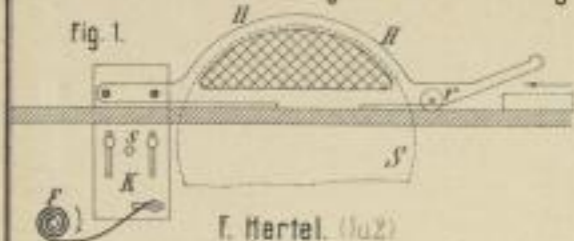

Duisburger Maschinenfabrik (3)

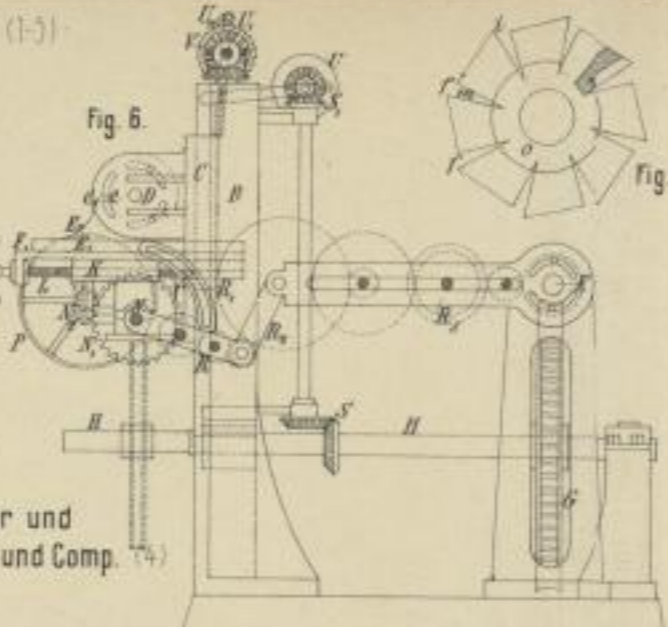

Sentker und Th. Galow und Comp.

Actiengesellschaft zu Lipine (5)



C.E. Albro's Zahnräder Fräsmaschine. (6-10)

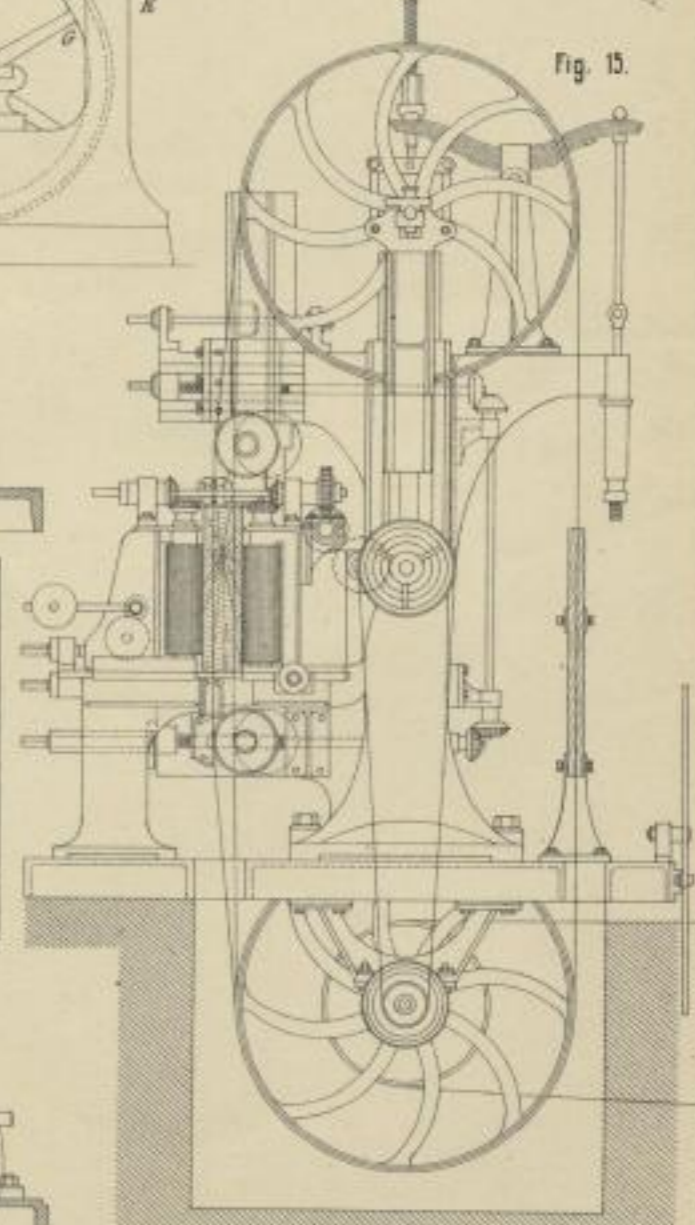
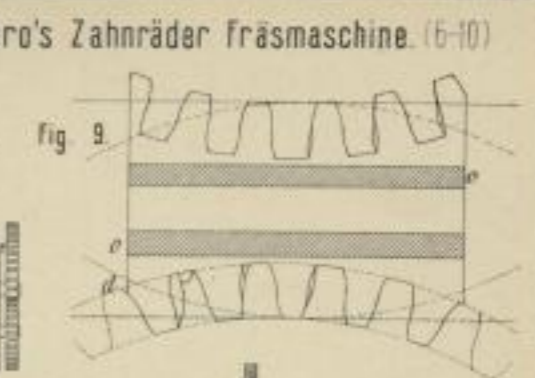
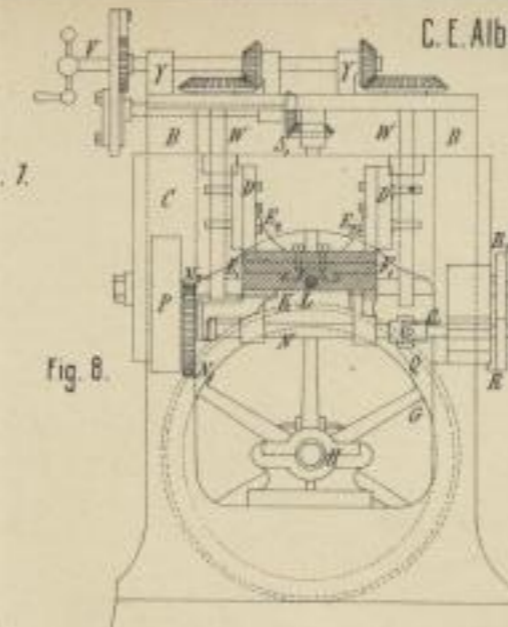

Aylesbury's Blockbandsäge. (15)

W. Waston's Schleifapparat für Werkzeuge. (11u12)

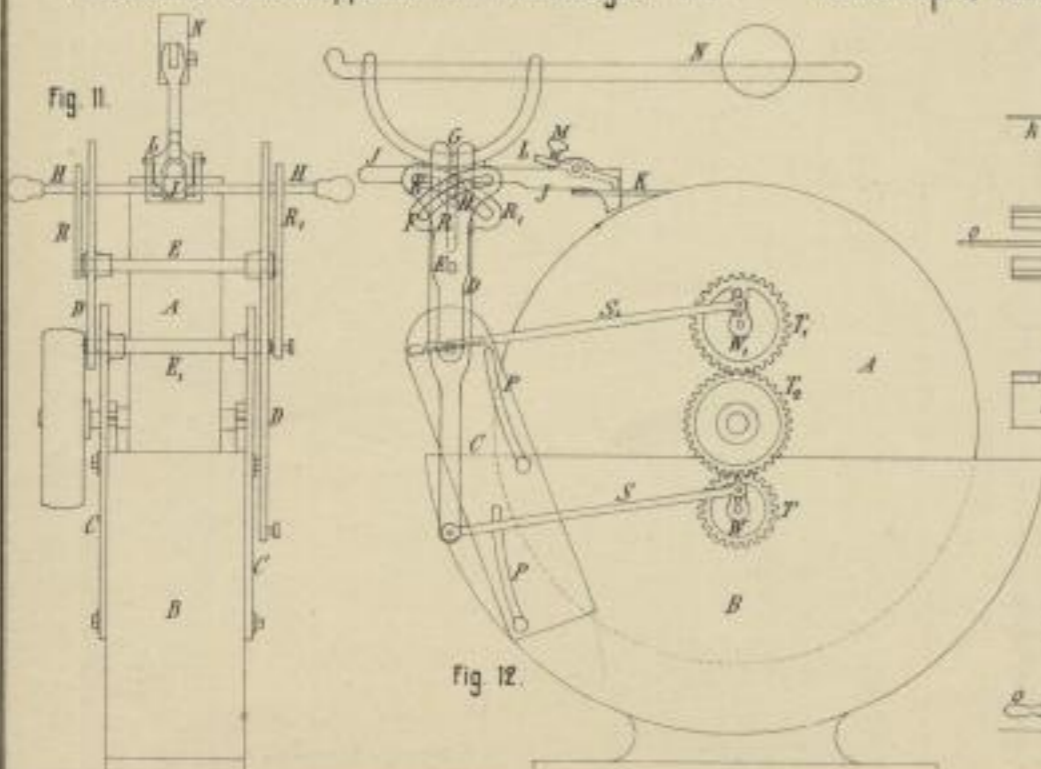

Hünorkopf's Bleistiftstempelpresse. (13u14)

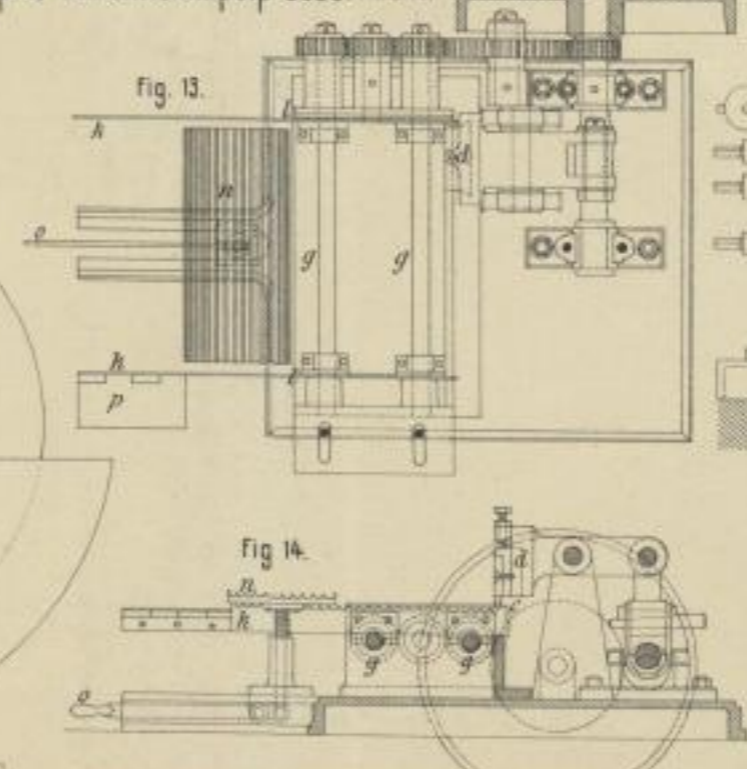

Verf. Anat. v. P. Wörler, Darmstadt.

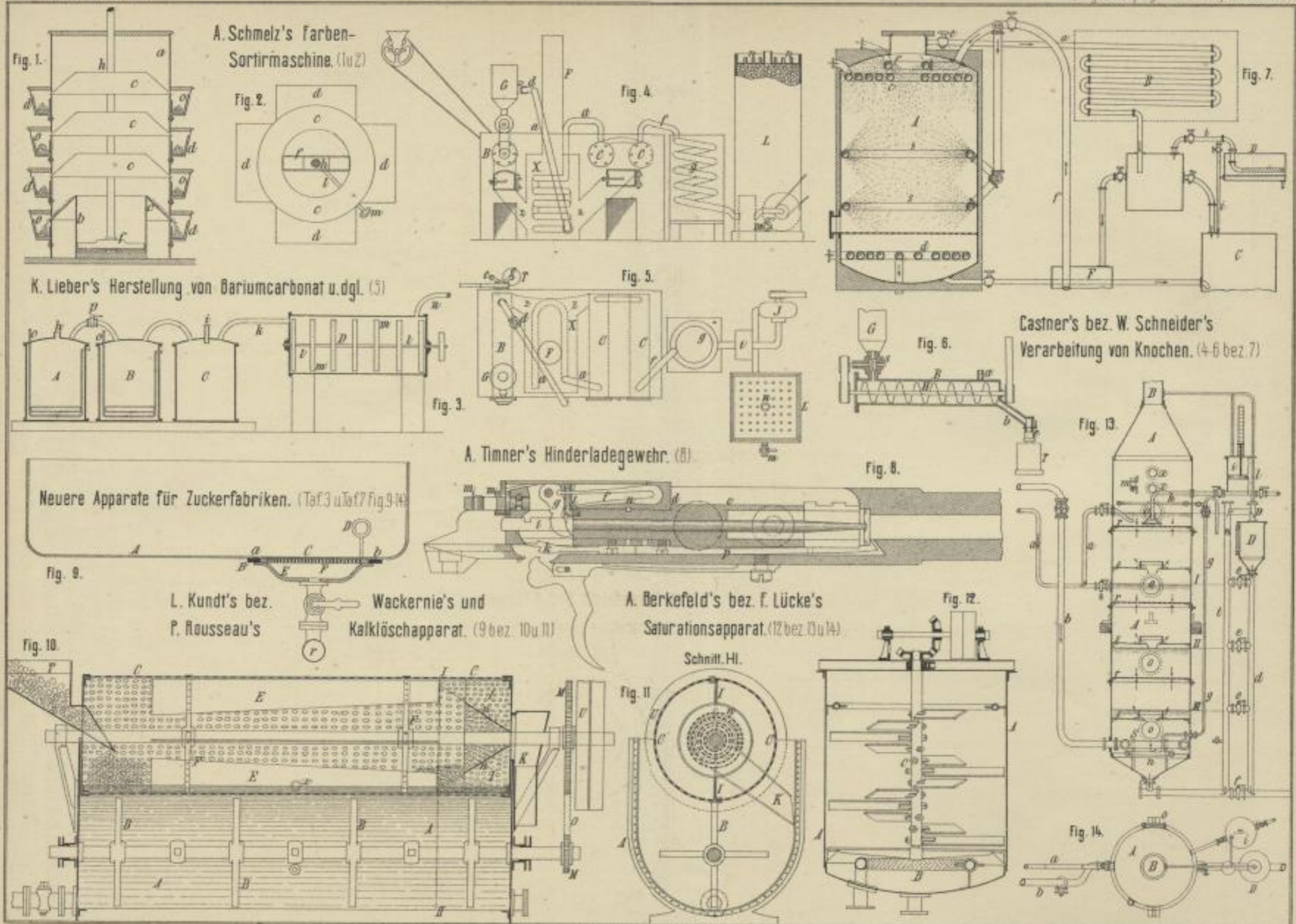

Lith. Anst. v. F. W. Biele, Darmstadt



Hervier's Kesselausrüstung. (1)

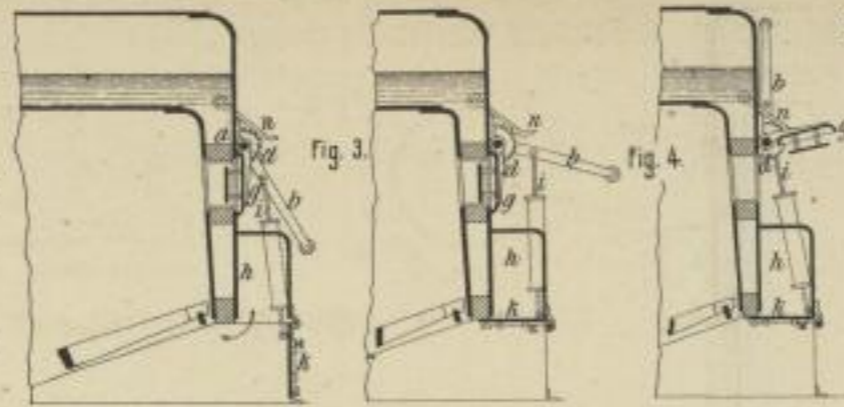
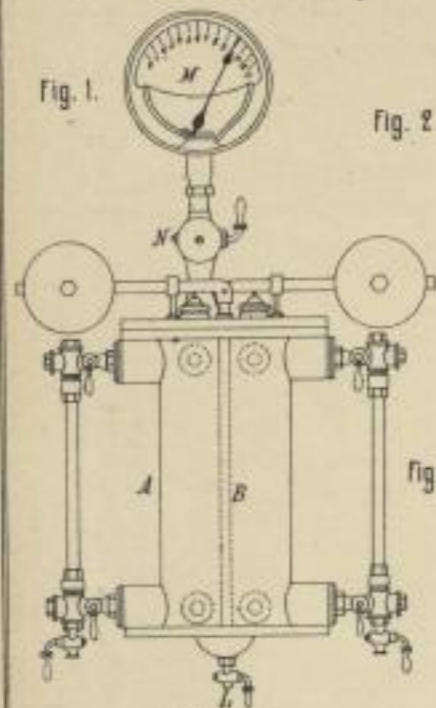

Schichau's feuerthür-Einrichtungen. (2-8)

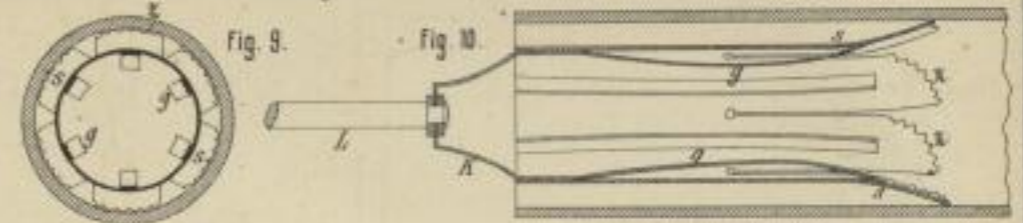

O. Wirth's Rohrreiniger. (9 u 10)

Stous-Sloot's Apparat zur Prüfung von Siederöhren. (11-13)

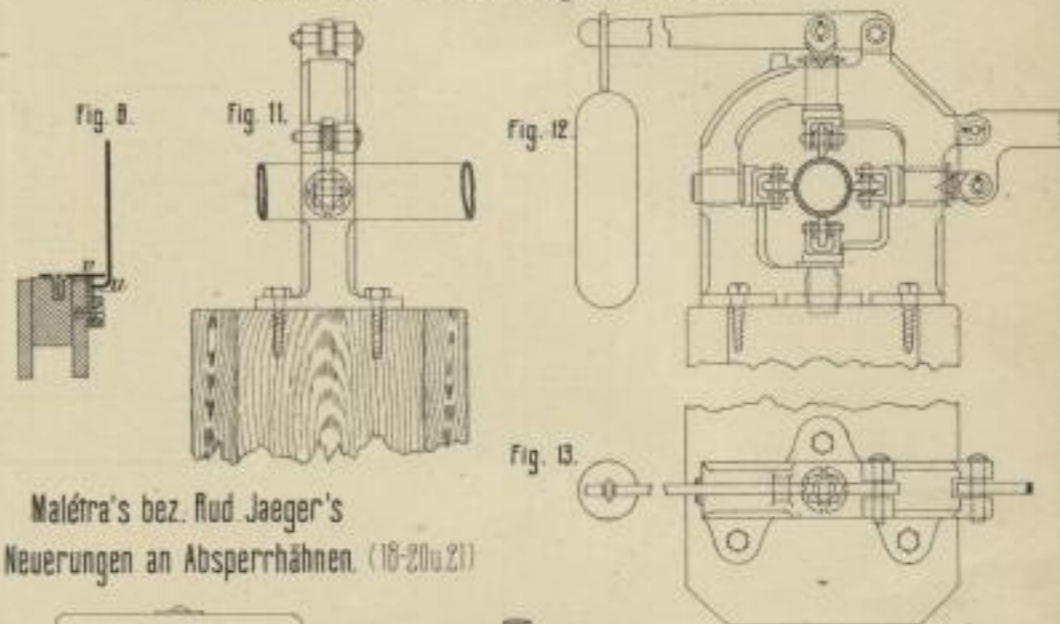

C. Mollerup's selbstthätiger Schmierapparat. (14 u 15)

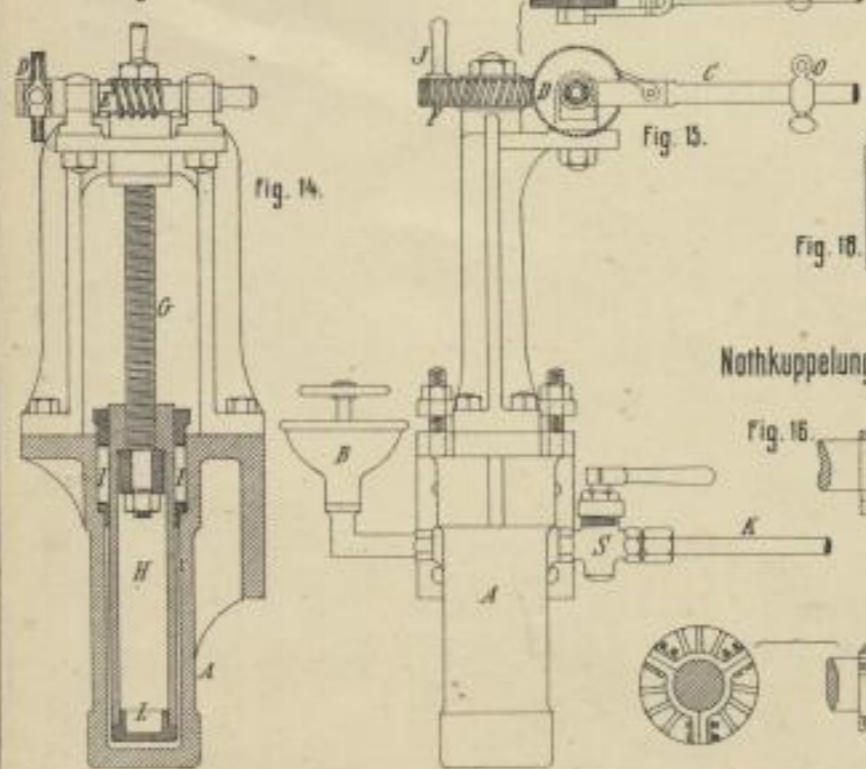

Malétra's bez. Rud. Jaeger's Neuerungen an Absperrhähnen. (18-20 u 21)

Nothkuppelung für Schraubenwellen. (16 u 17)

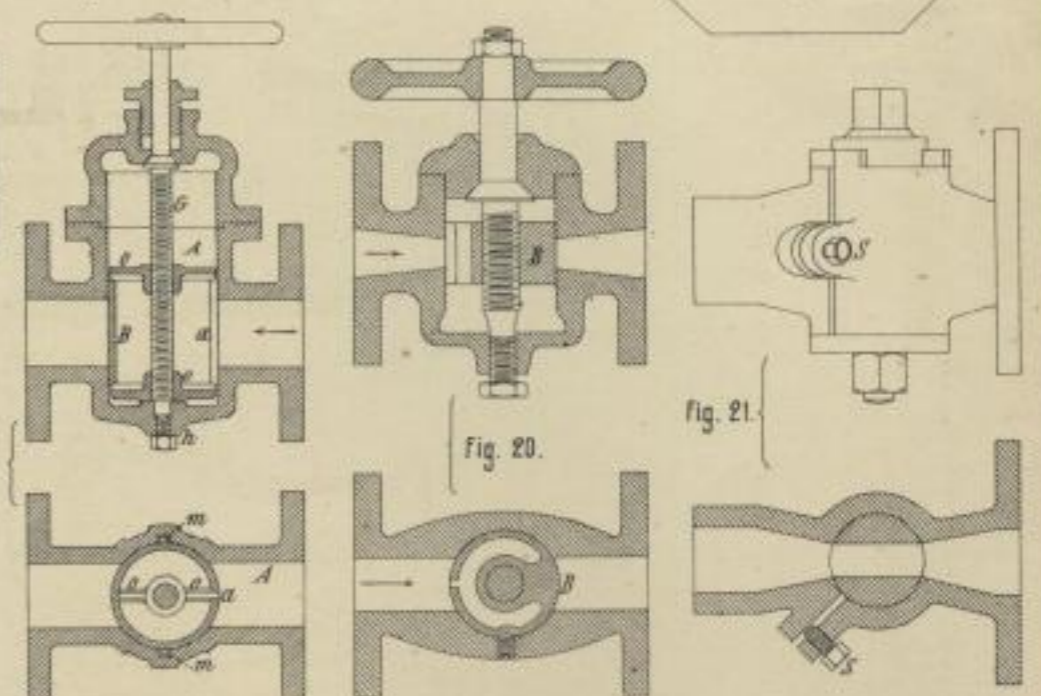
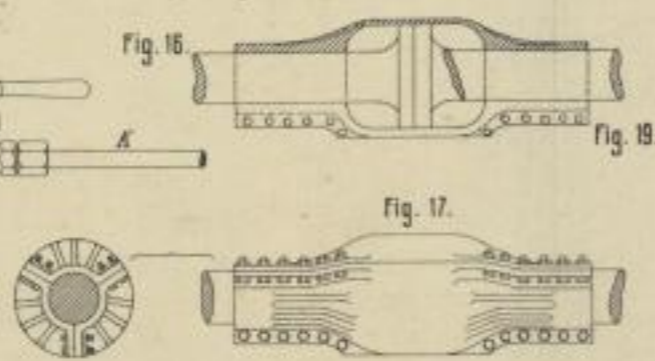

Lith. Anst. v. F. Wrtz, Darmstadt.



### Neuerungen in der Dieferei. (Taf. 2 u. 9)

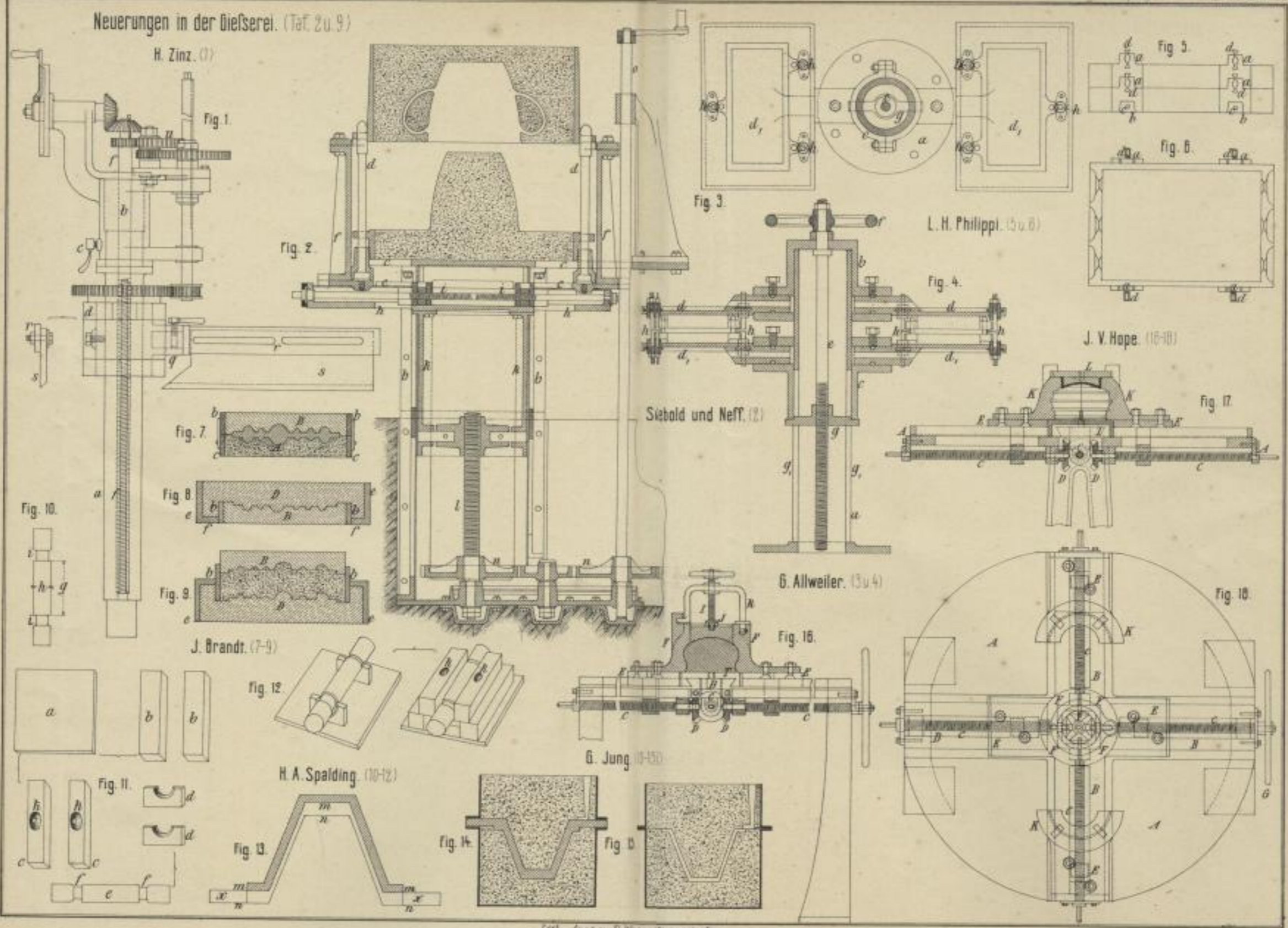

Lith. Anst. v. F. W. W. Darmstadt.

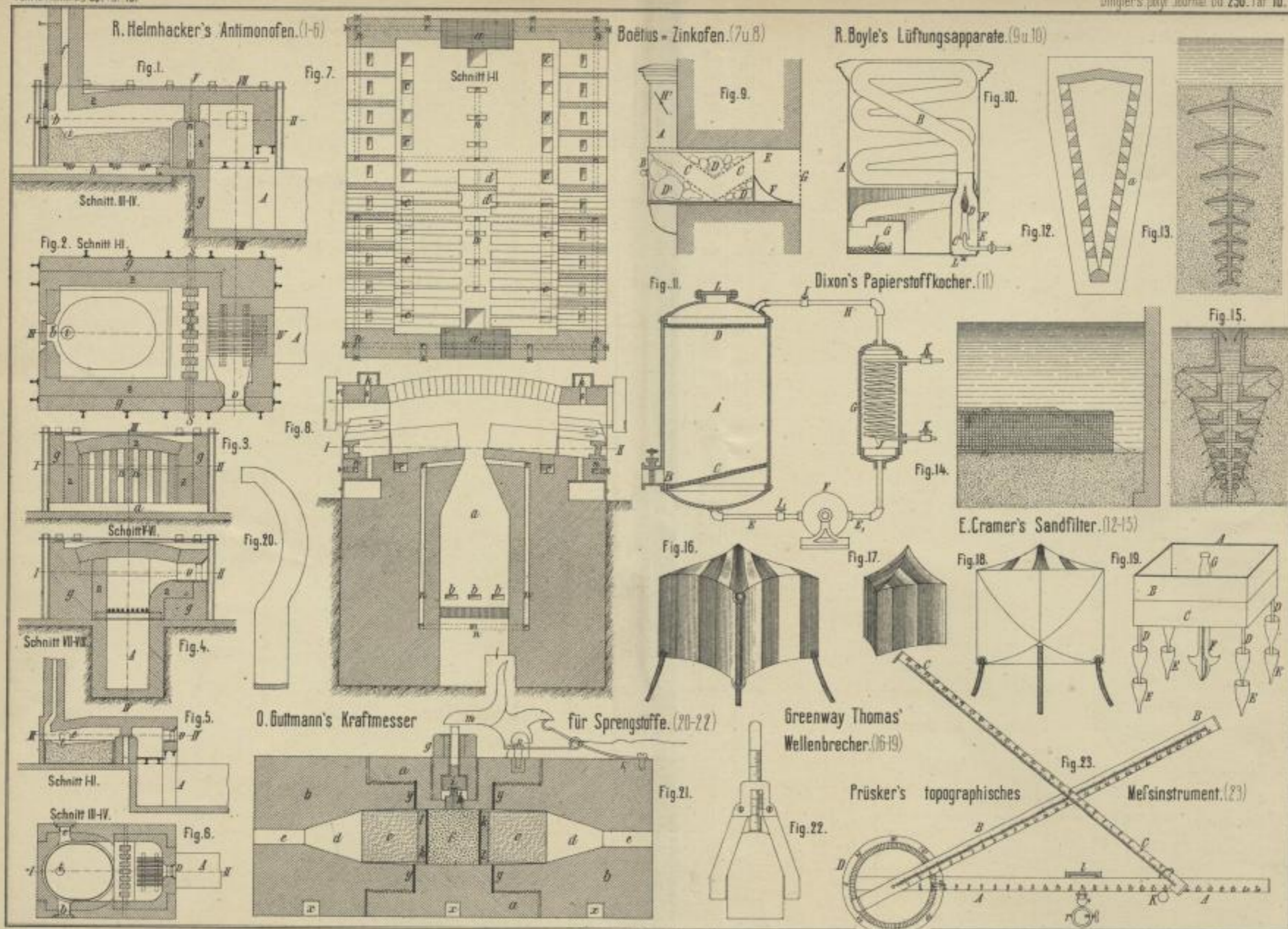

Lab. Anat. v. F. Wern. Darmstadt



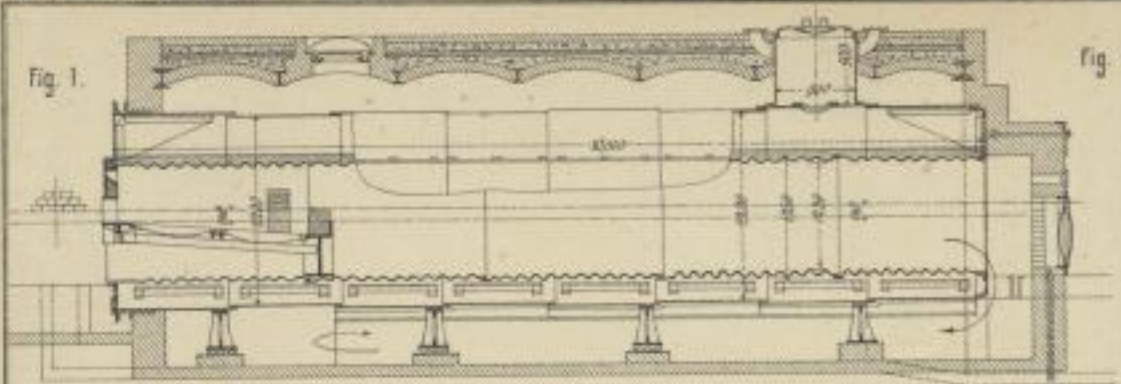

Fig. 1. Schutz und Knaut's Seifrohrkessel mit großem Wellrohre. (1-3)

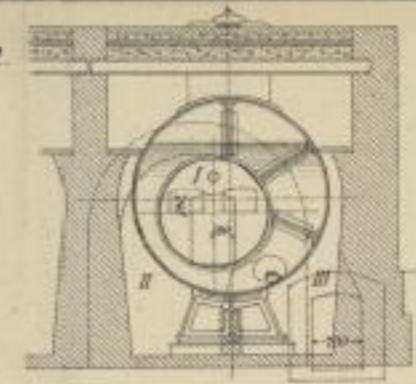
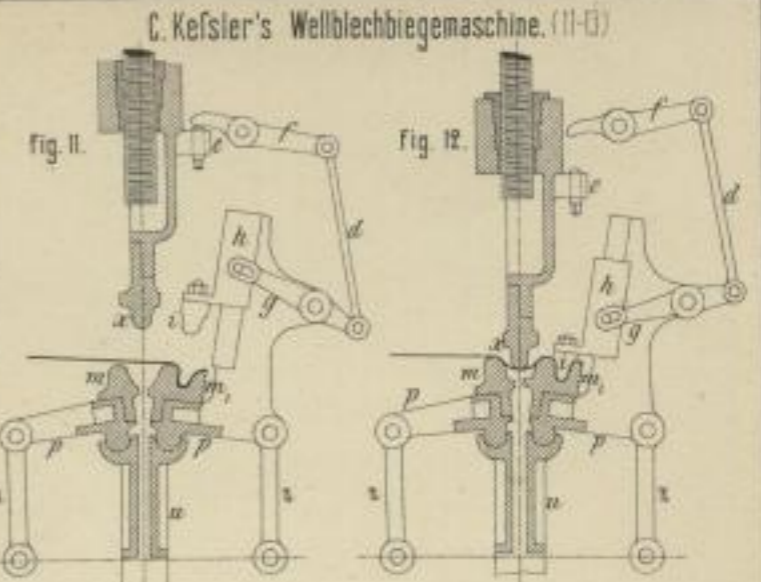

Fig. 2.



C. Kefsler's Wellblechbiegemaschine. (11-13)

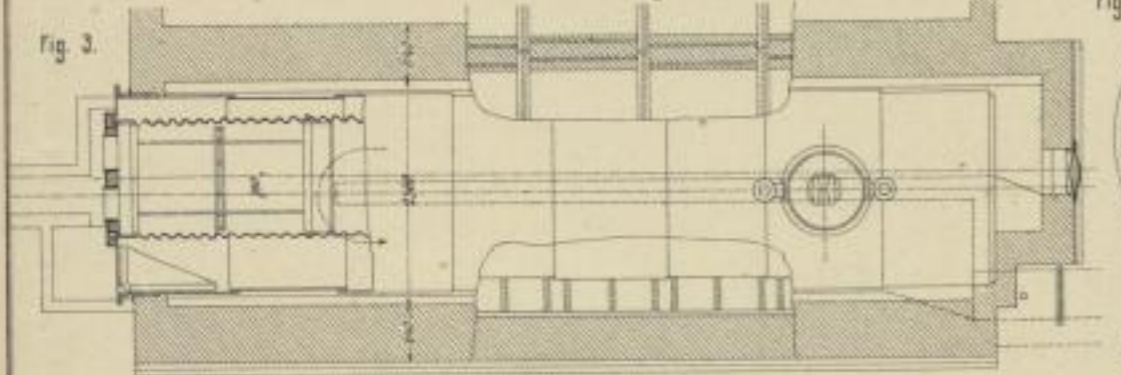

Fig. 3.

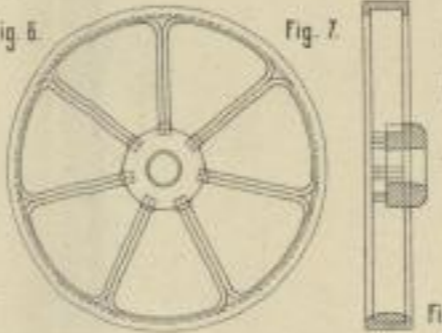

Fig. 6.

Fig. 7.

Garnier's Eisenbahnwagenrad. (6-10)

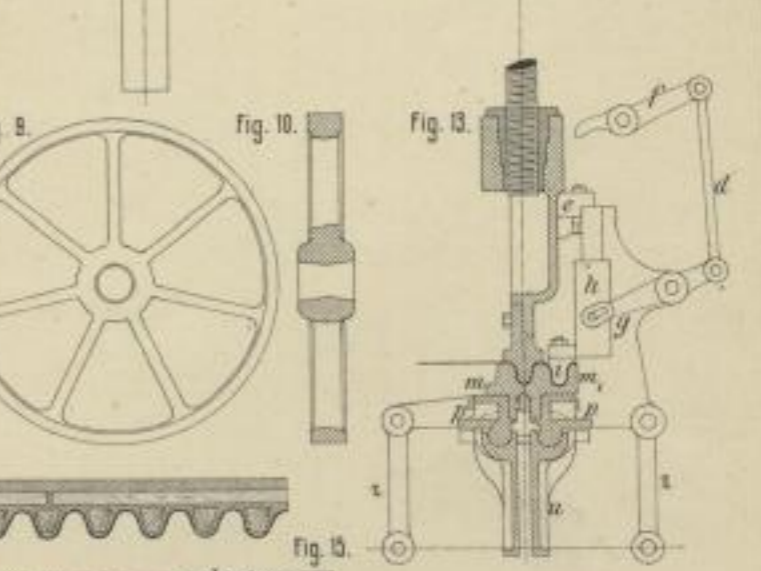

Fig. 11.

Fig. 12.

Fig. 13.

Fig. 14.

Fig. 15.

Ferd. Fischer: Verdampferversuche. (1-3 u. 5)

Zweiflammrohrkessel (4 u. 5)

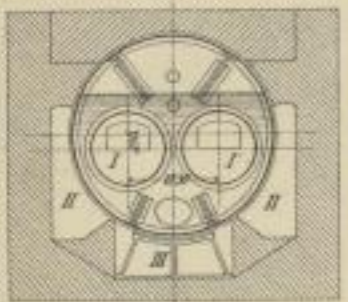

Fig. 4.

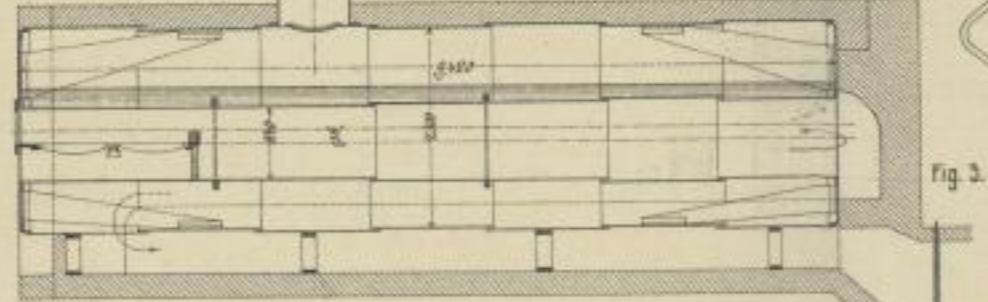

Fig. 5.

D. Müller's bez Kroog's Filterpresse. (16-18 bez 19)

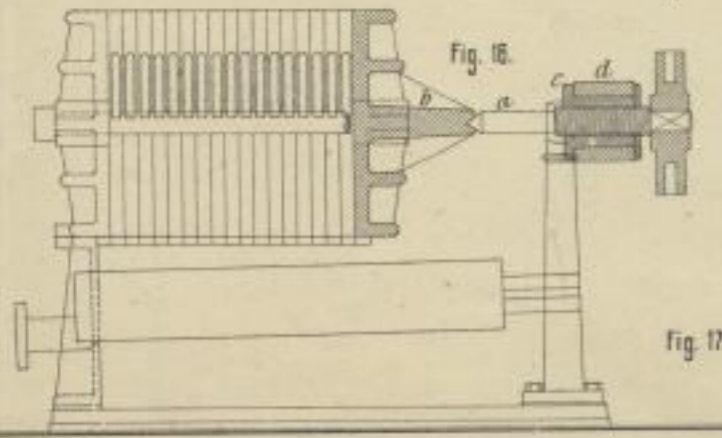

Fig. 16.

Fig. 17.

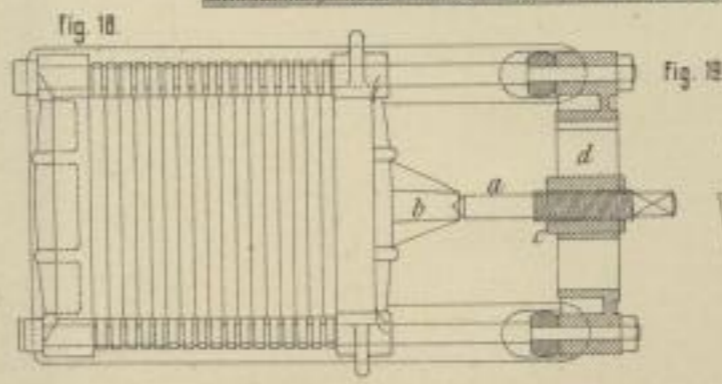

Fig. 18.

Fig. 19.



H. Klette's Zwischendecken-Construction. (13 u. 14)

Lith. Anst. v. F. Weyg, Darmstadt.

Neuerungen in der Gießerei. (Taf 2, 9 u 12)

Levasseur. (1-3, 5 u 6)

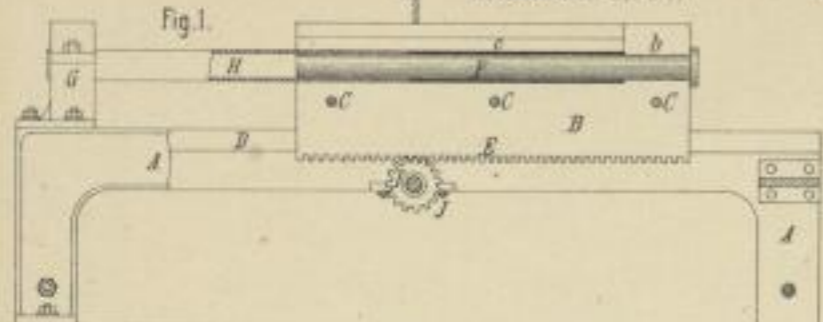
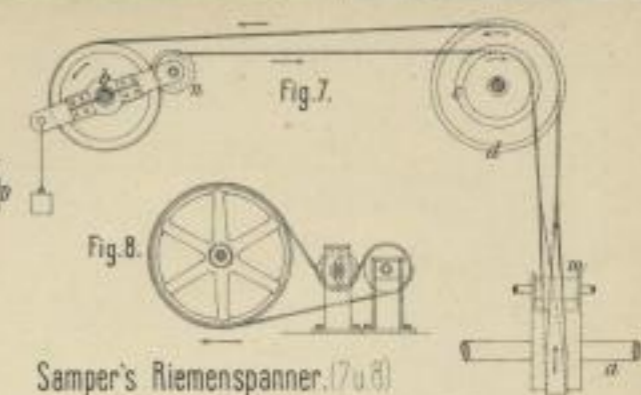
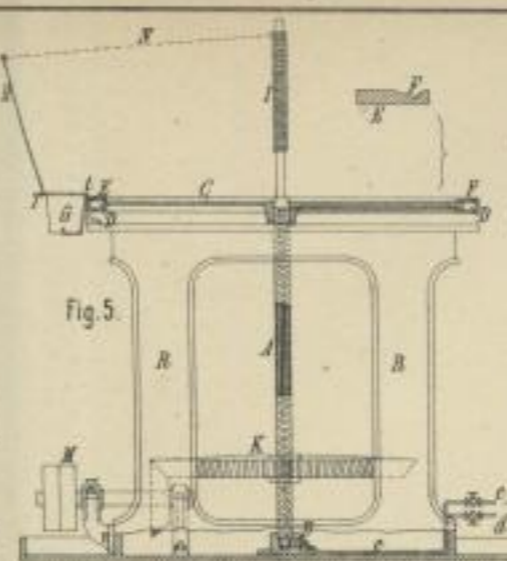
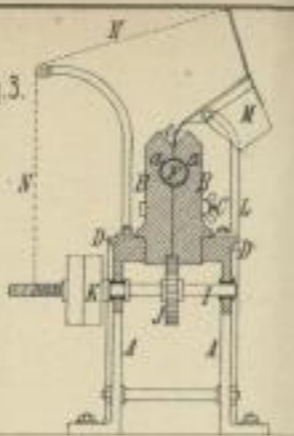
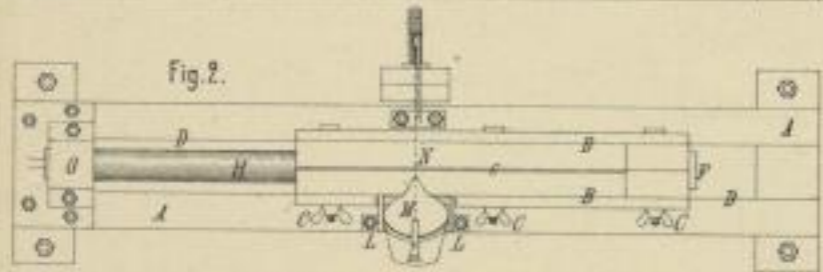

Fig. 3.



Samper's Riemenspanner. (7 u 8)



Aitken. (4)

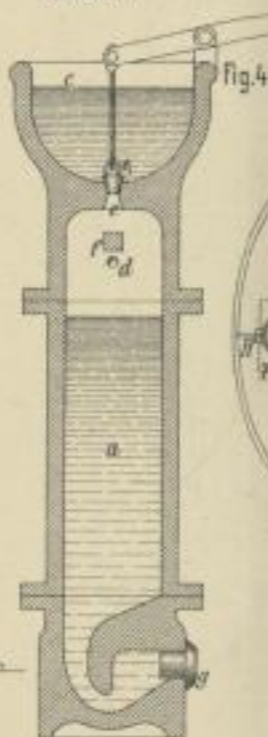

Stewart's Kapselgebläse. (9 u 10)

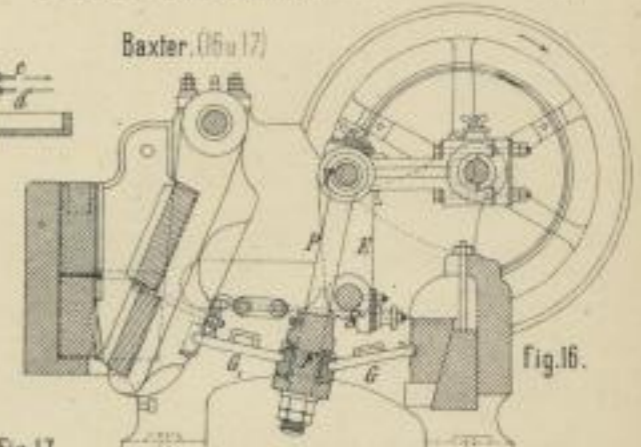
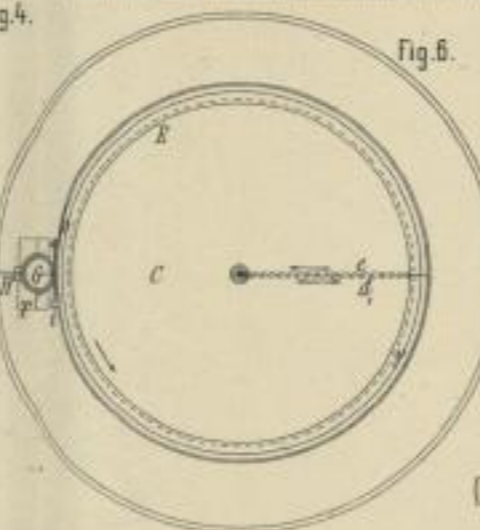
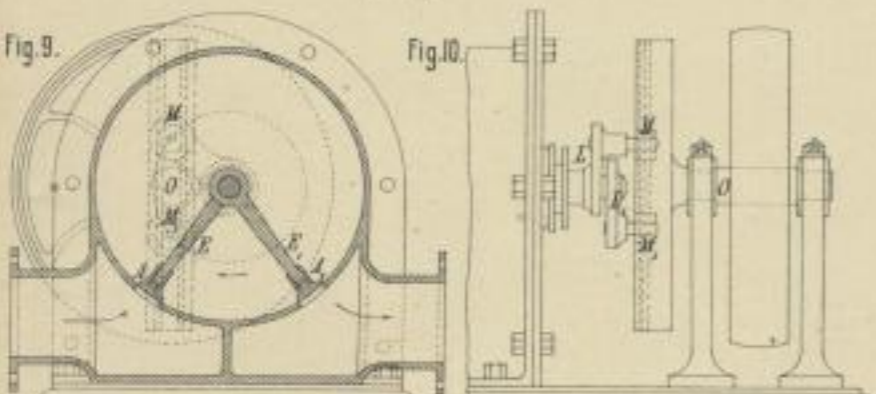

Baxter. (16 u 17)

Grahl und Hoehl's Blattsteinhalter. (11)

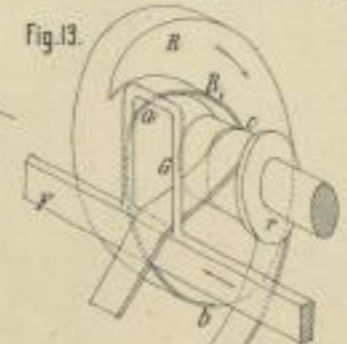
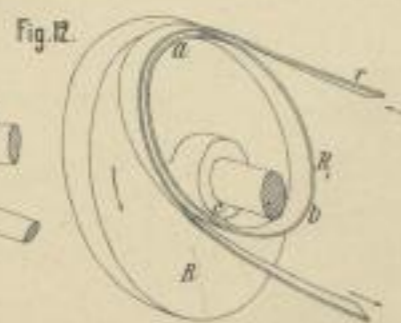
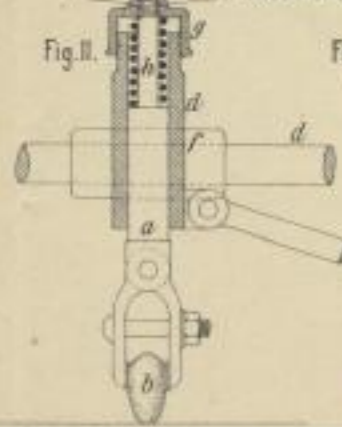

Berzen's bez Reinhard's Riemenauflieger. (12 u 13 bez 14 u 15)



Huet. (19 u 20)

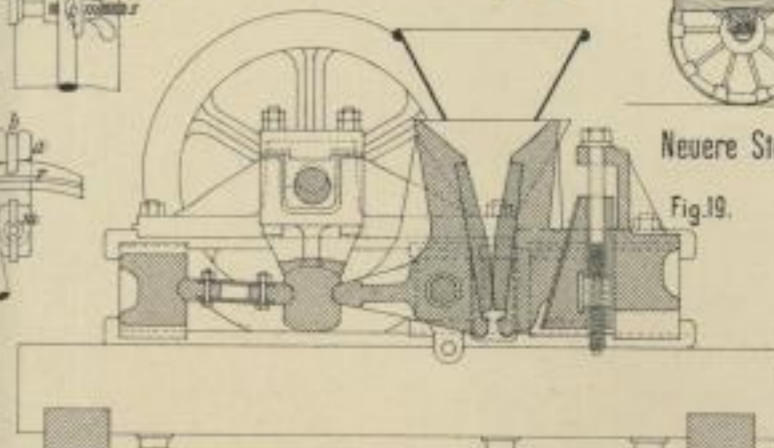

Neuere Steinbrechmaschinen. (16-20)

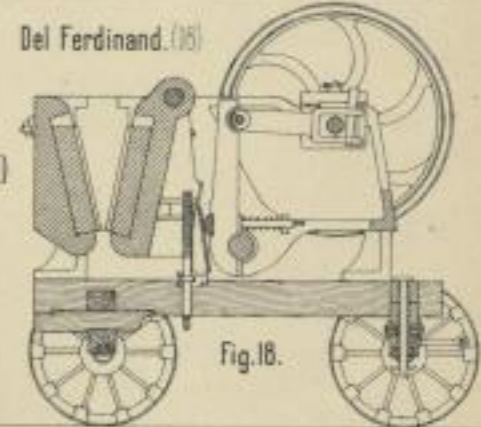

Del Ferdinand. (16)

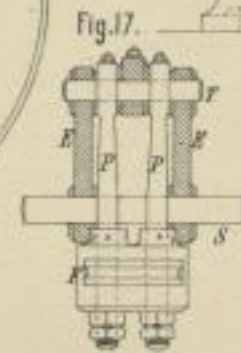
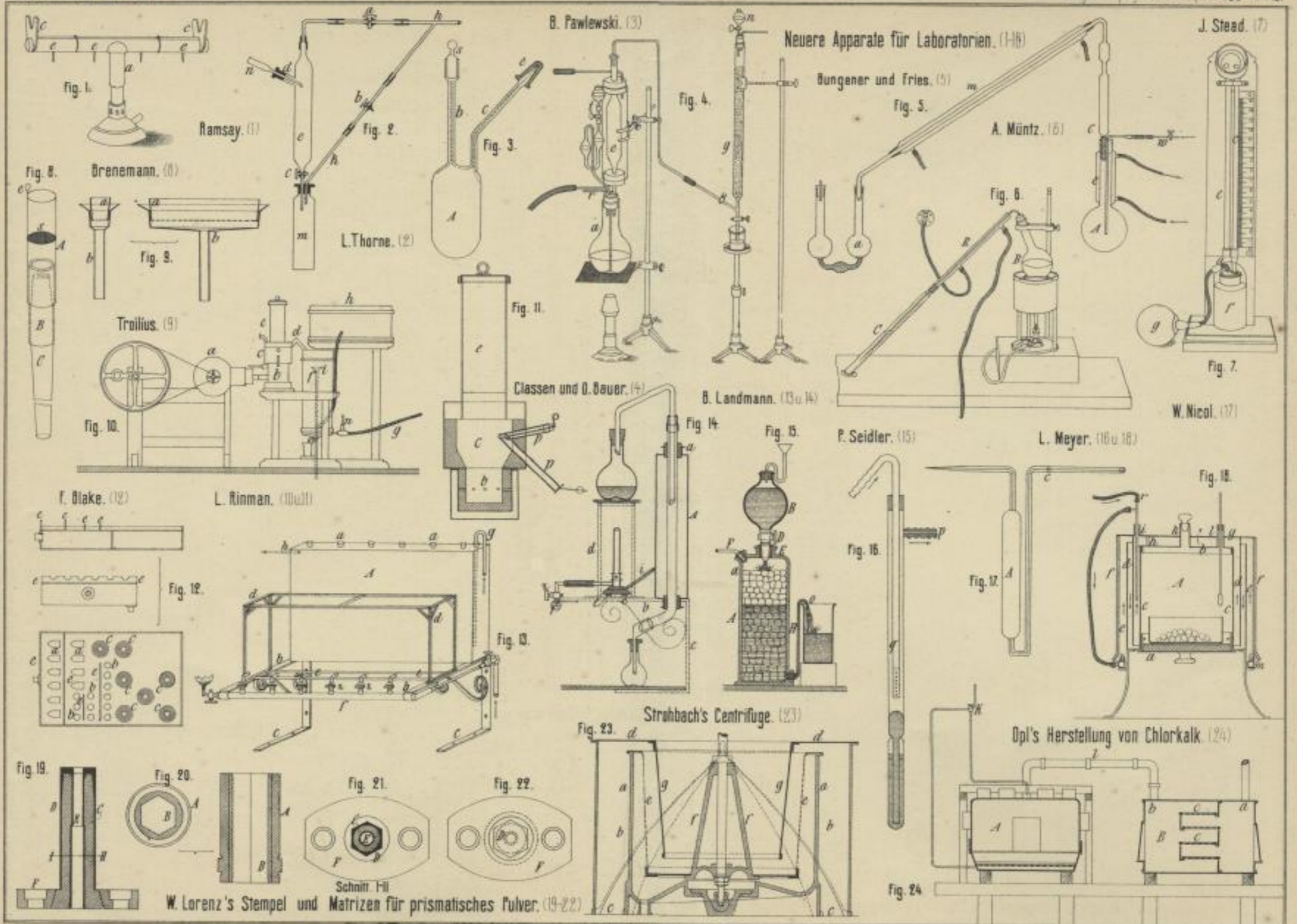

Fig. 17.

Fig. 18.

Fig. 20.

Lith. Anst. v. P. W. Schmidt.



Lith. Anst. v. F. Werts, Darmstadt.



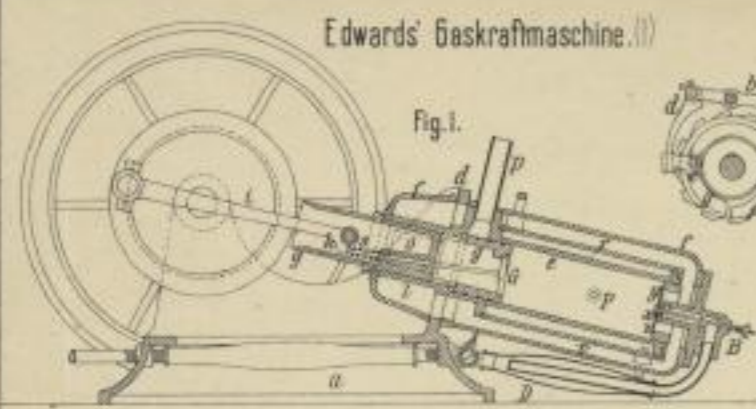

Edwards' Gaskraftmaschine. (11)



Fig. 4.

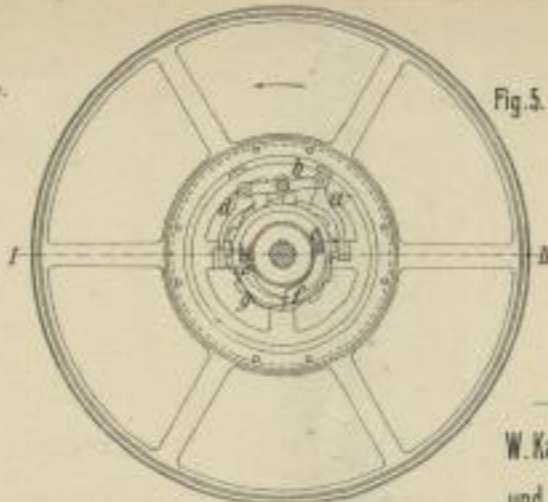

Fig. 5.

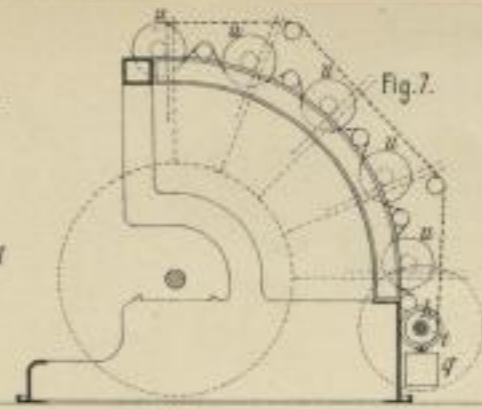

Fig. 7.

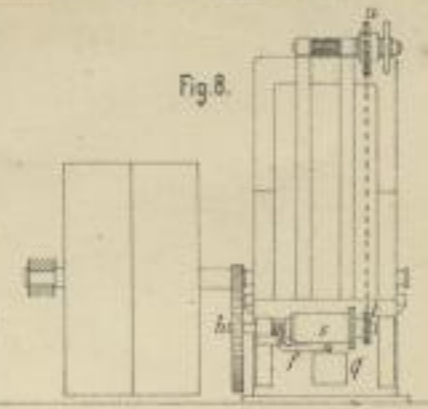

Fig. 8.



Storz's Schlauchverbindung. (2 u 3)

Fig. 2.

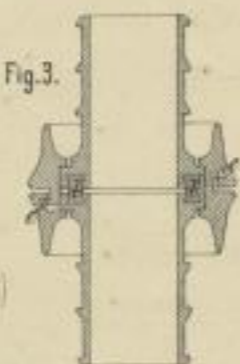

Fig. 3.

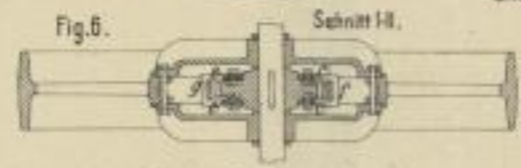

Fig. 6.

Schnitt 14.

W. Kankelwitz's Kraftkuppelung und Regulirvorrichtungen. (4-6, 7-11)

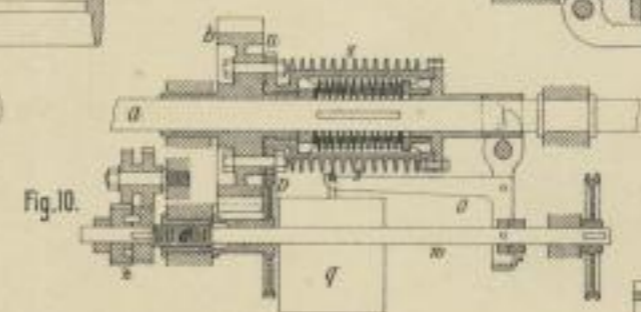

Fig. 10.

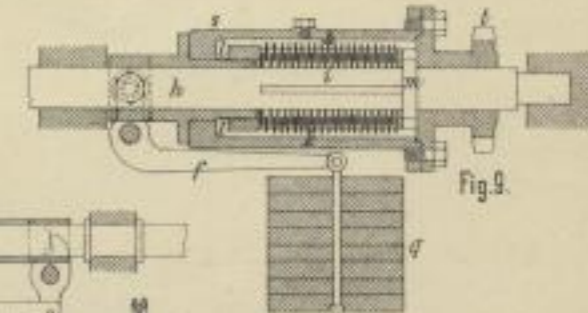

Fig. 9.

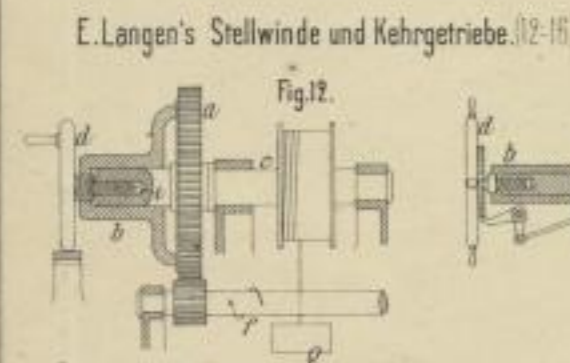

Fig. 12.

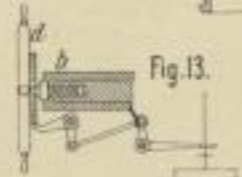

Fig. 13.

Laurent und Collot's Prefspumpe. (17 u 18)

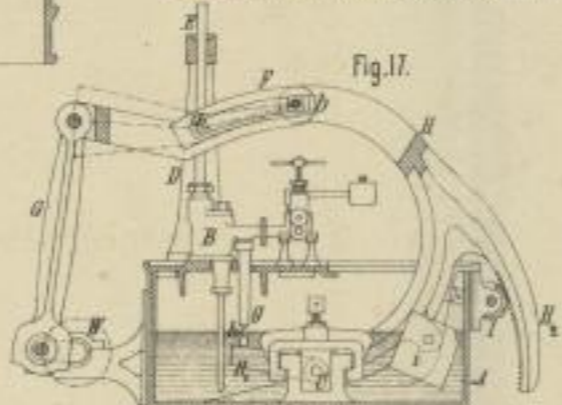

Fig. 17.

J. Emunds' Presse für Metallröhren. (21)

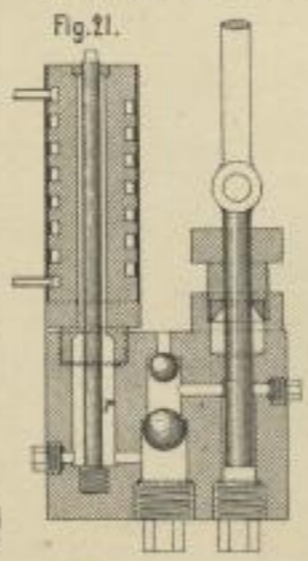

Fig. 21.

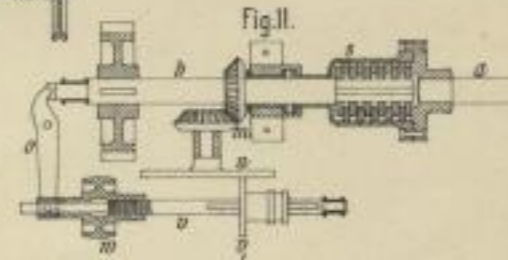

Fig. 11.

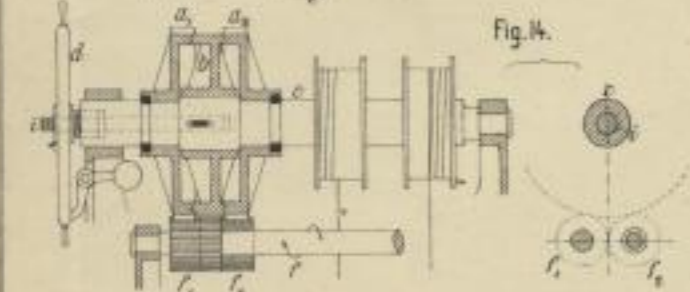

Fig. 14.

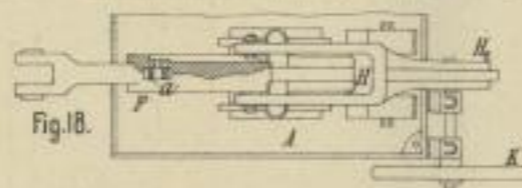

Fig. 18.

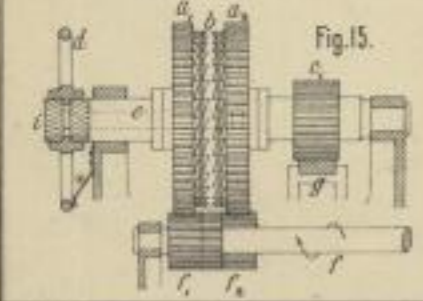

Fig. 15.



Fig. 16.



Fig. 19.

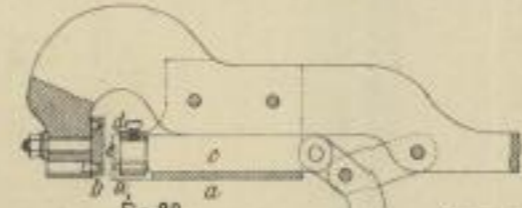

Fig. 20.

Gravenhorst's Lochzange. (19 u 20)

Burrell's Regulator. (22 u 23)

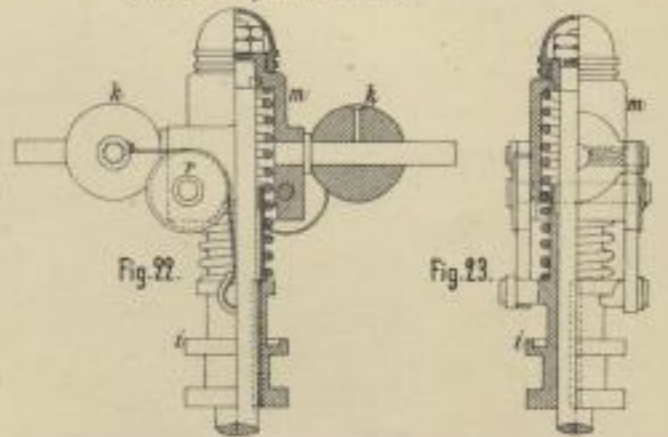
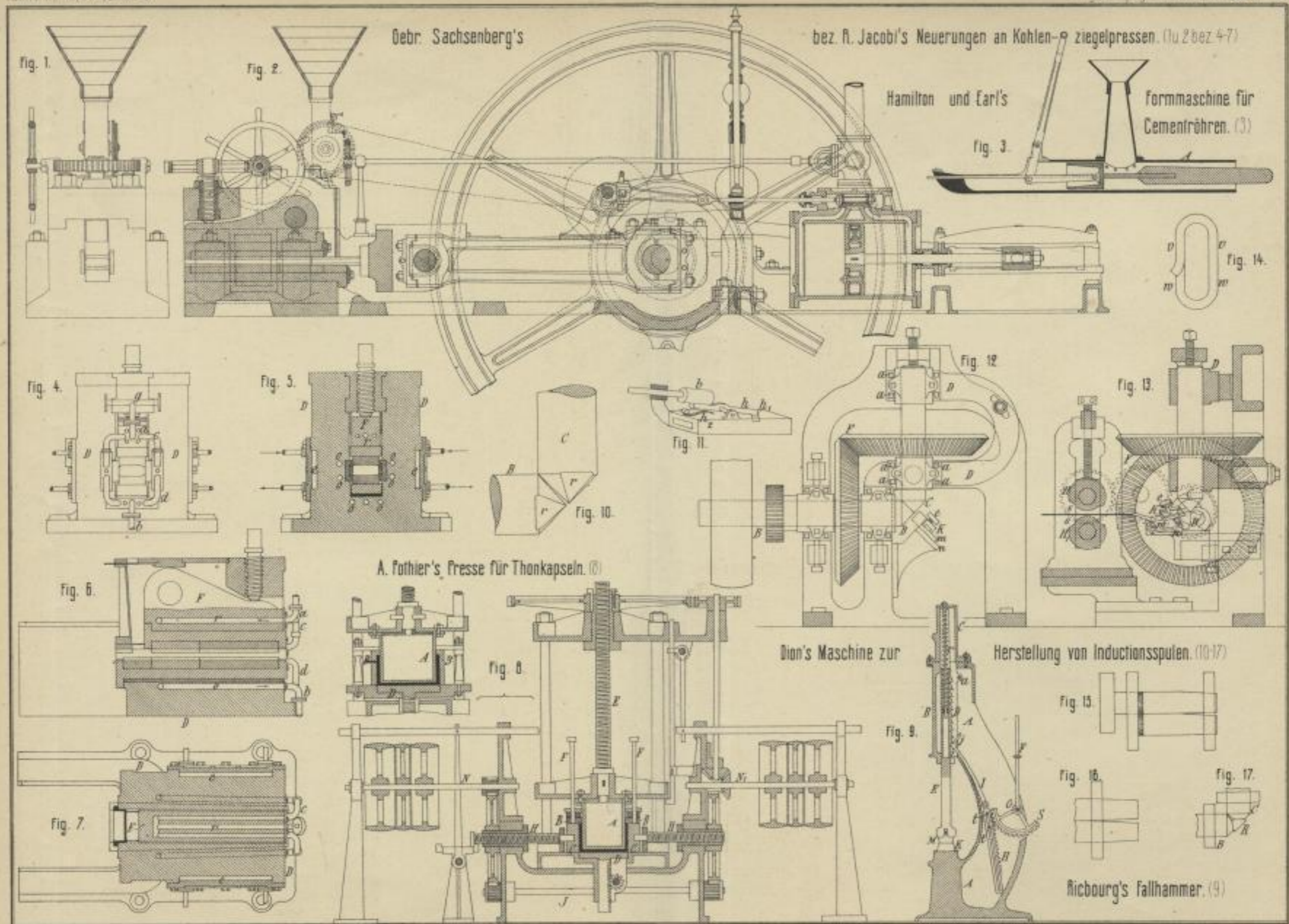

Fig. 22.

Fig. 23.

Lith. Anst. v. F. Wilm. Darmstadt.







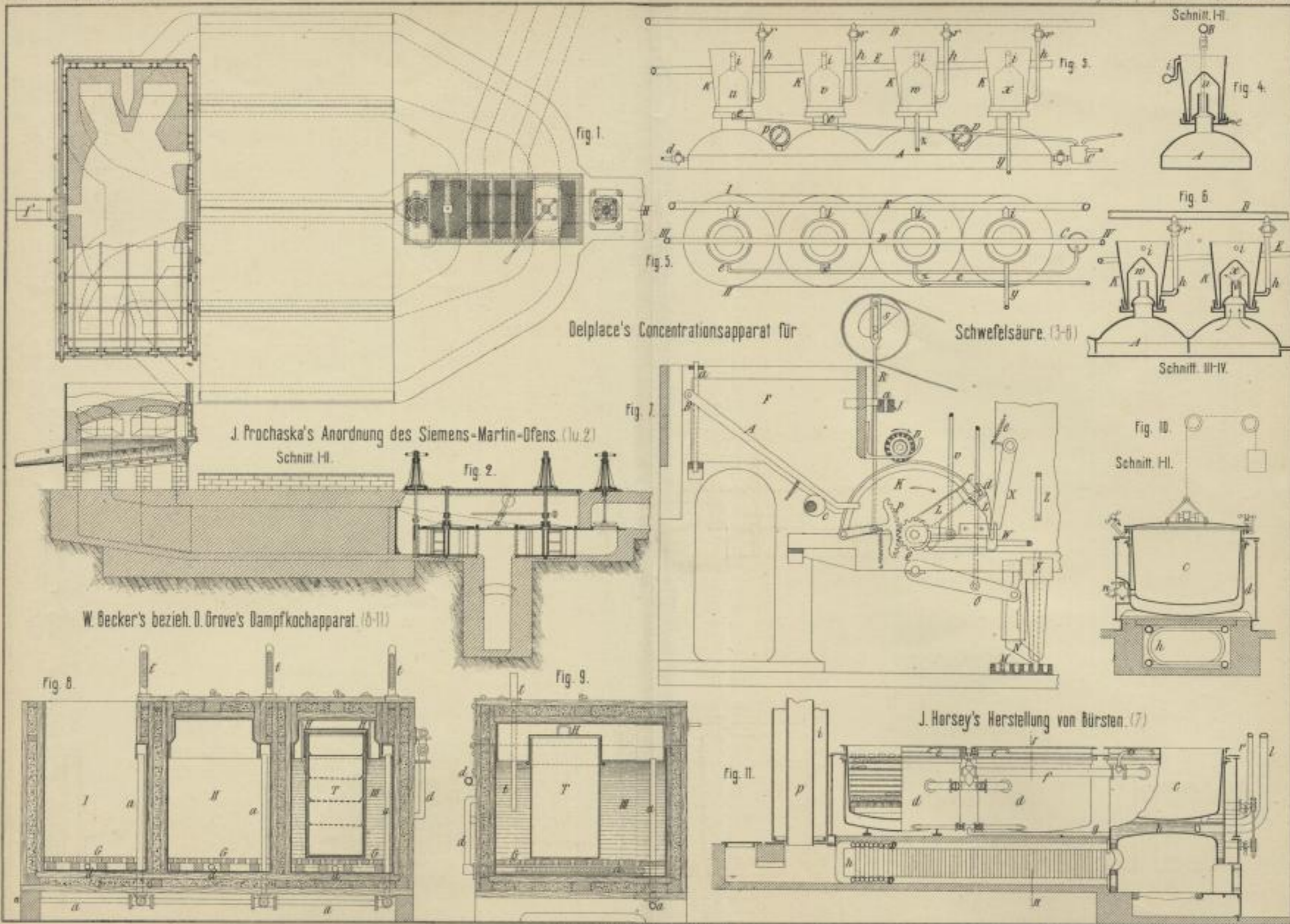

Delplace's Concentrationsapparat für

Schwefelsäure. (3-6)

J. Prochaska's Anordnung des Siemens-Martin-Ofens. (1u.2)

Schnitt III.

W. Becker's bezieh. O. Grove's Dampfkochapparat. (8-11)

J. Horsey's Herstellung von Bürsten. (7)

Lith. Anst. v. F. Wirtz, Darmstadt

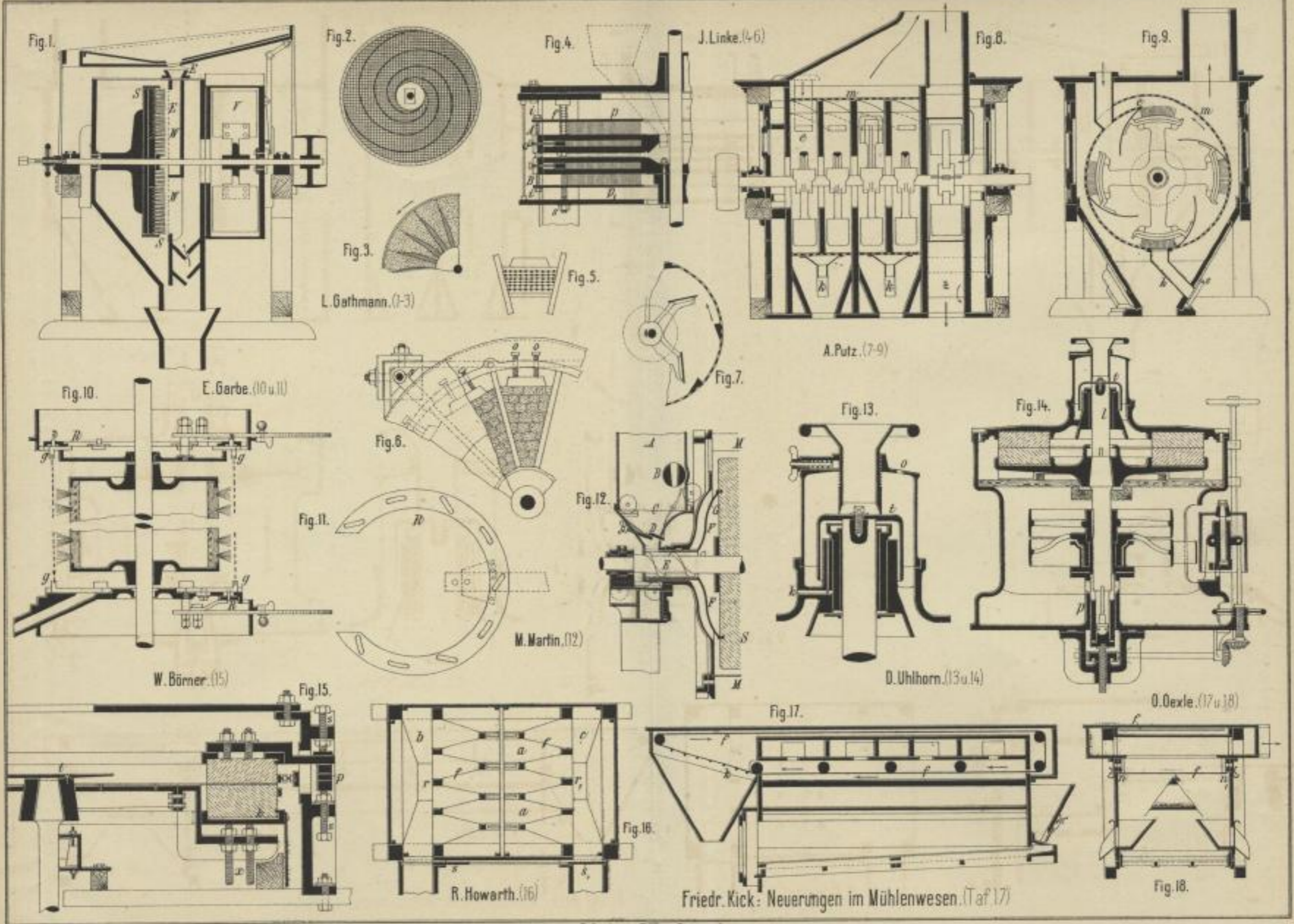

*Lehr. Anst. v. F. Wirtz, Darmstadt.*

Friedr. Kick: Neuerungen im Mühlenwesen. (Taf. 17)



Neuerungen an Closeteinrichtungen. (1-14)

E. Oberländer. (1)

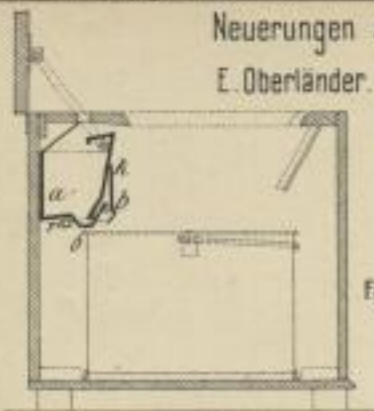

F. Mundt. (2)

Fig. 2.

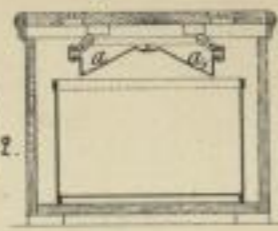
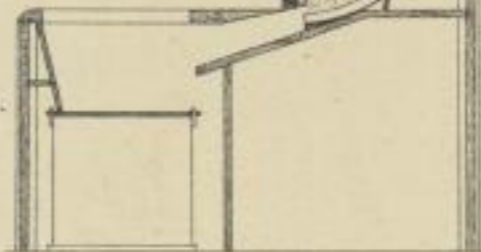

Fig. 1.

Fig. 3.



O. Schulz. (4)

Fig. 4.

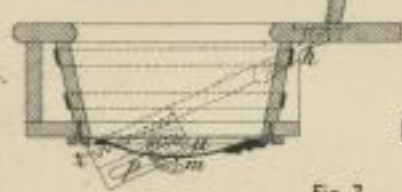

O. Poppe. (3)

Fig. 7.



Fig. 5.

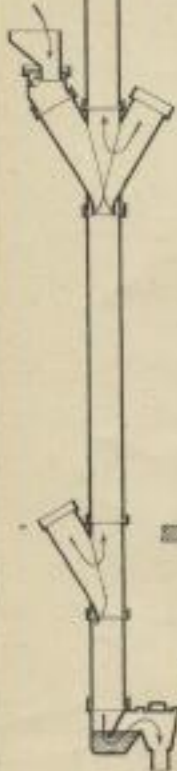
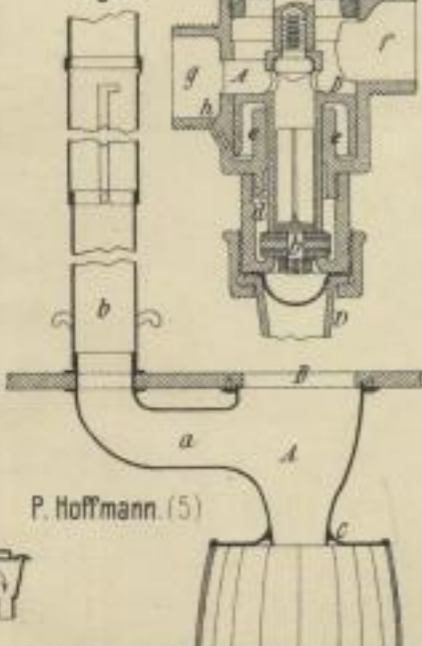

Fig. 6.



P. Hoffmann. (5)

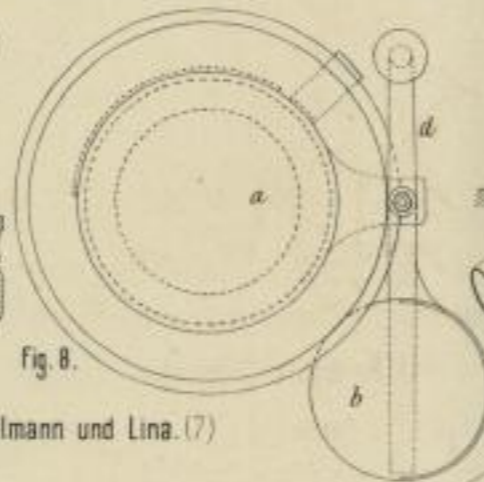

Fig. 8.

Kullmann und Lina. (7)

R. Henkel. (6)

L. Lebrecht. (8)

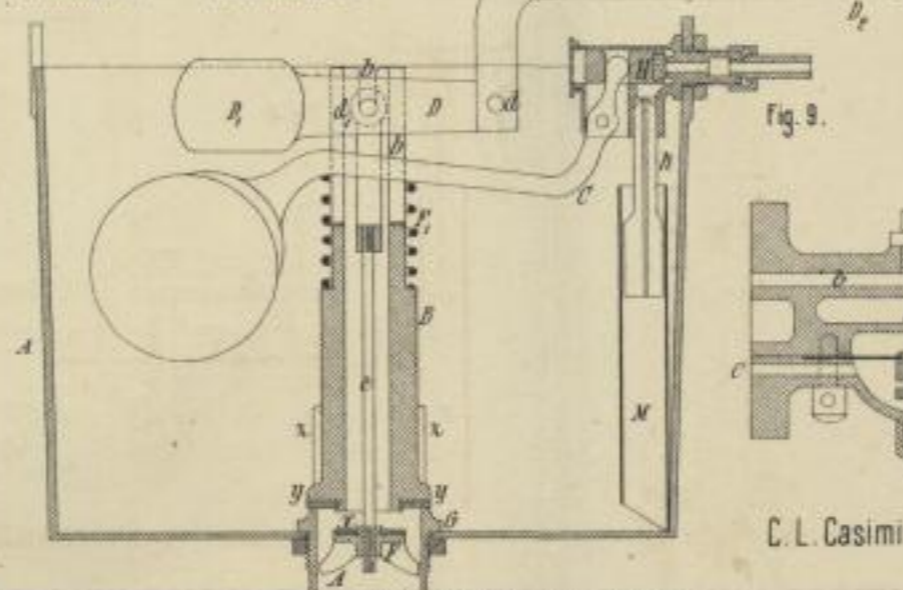
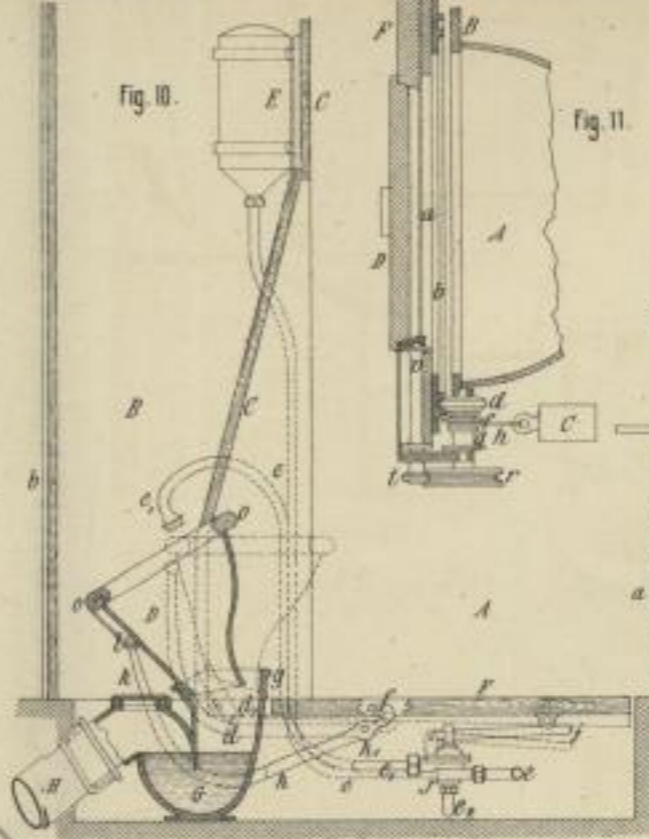

Fig. 9.

Kullmann und Lina. (10)

Fig. 10.



E. W. Zimmermann. (11-14)

Fig. 11.

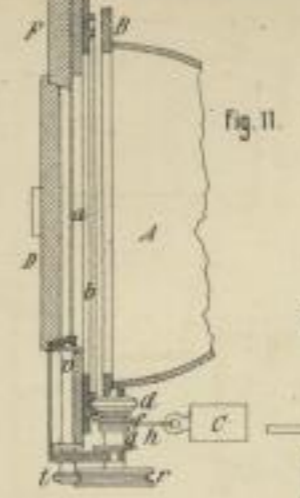

Fig. 12.

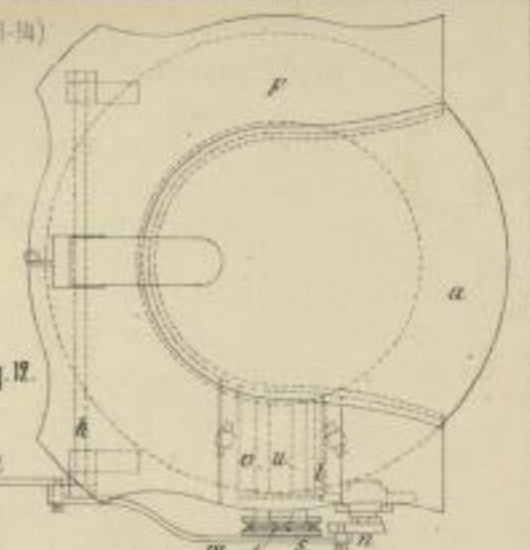
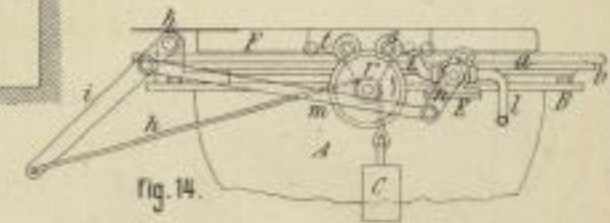

Fig. 13.



Fig. 14.



J. Kernaul's Eichhähne (15 u. 16)

J. Patrik. (9)

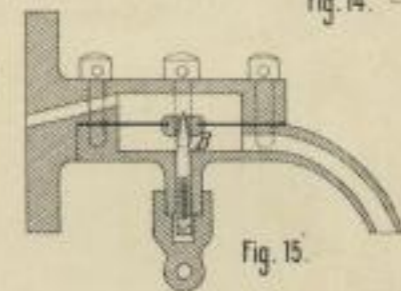

Fig. 15.

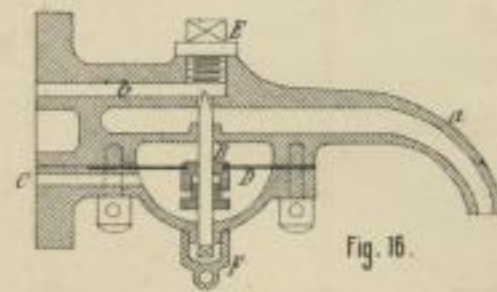
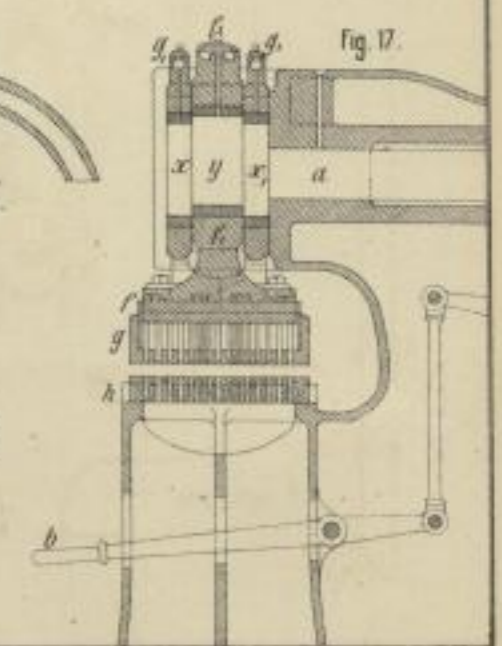

Fig. 16.

C. L. Casimir's Stanzmaschine. (17)

Fig. 17.



Lith. Anst. v. P. Wörts, Darmstadt



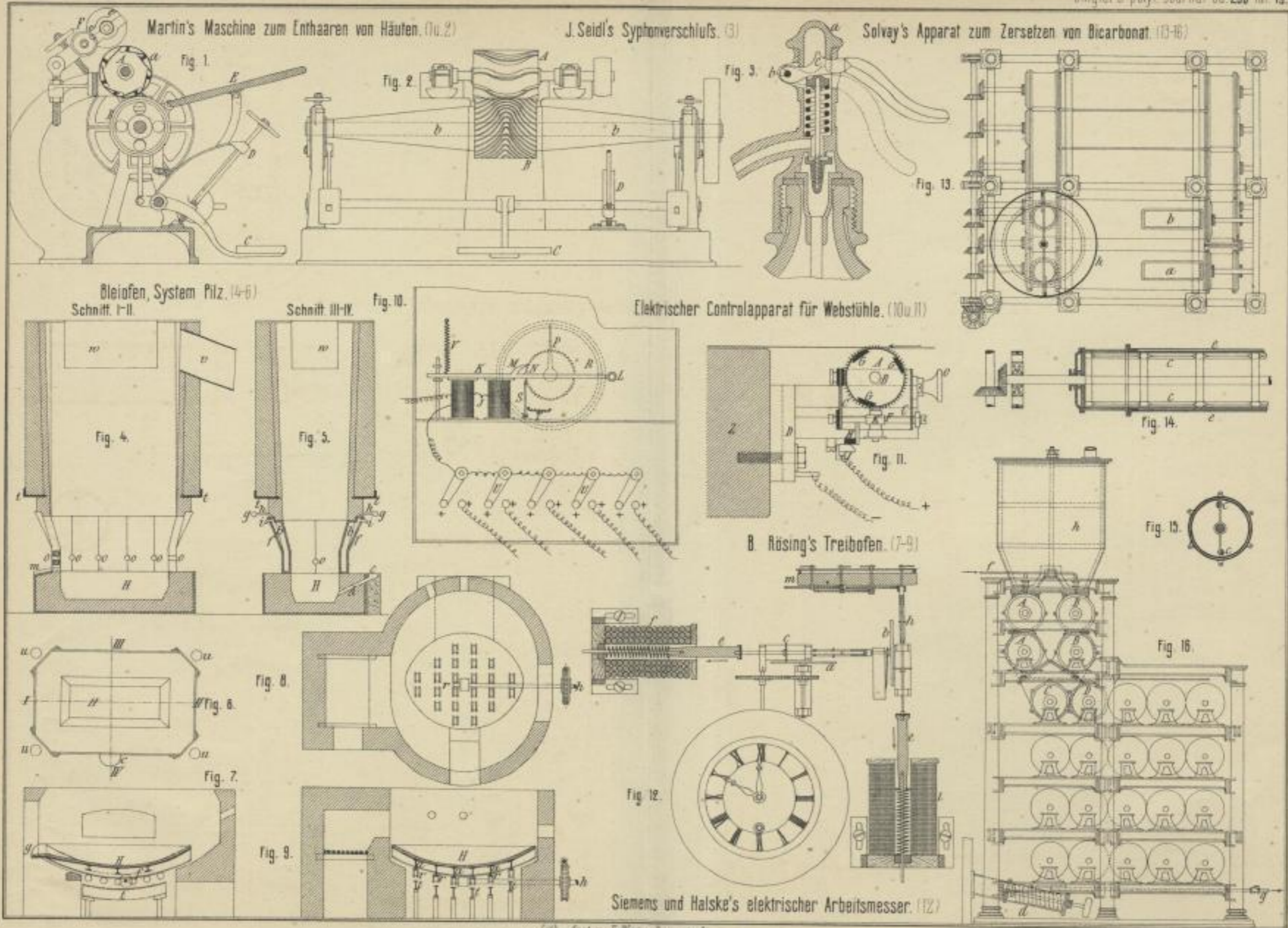

Lith. Anst. v. F. Wörner, Darmstadt.

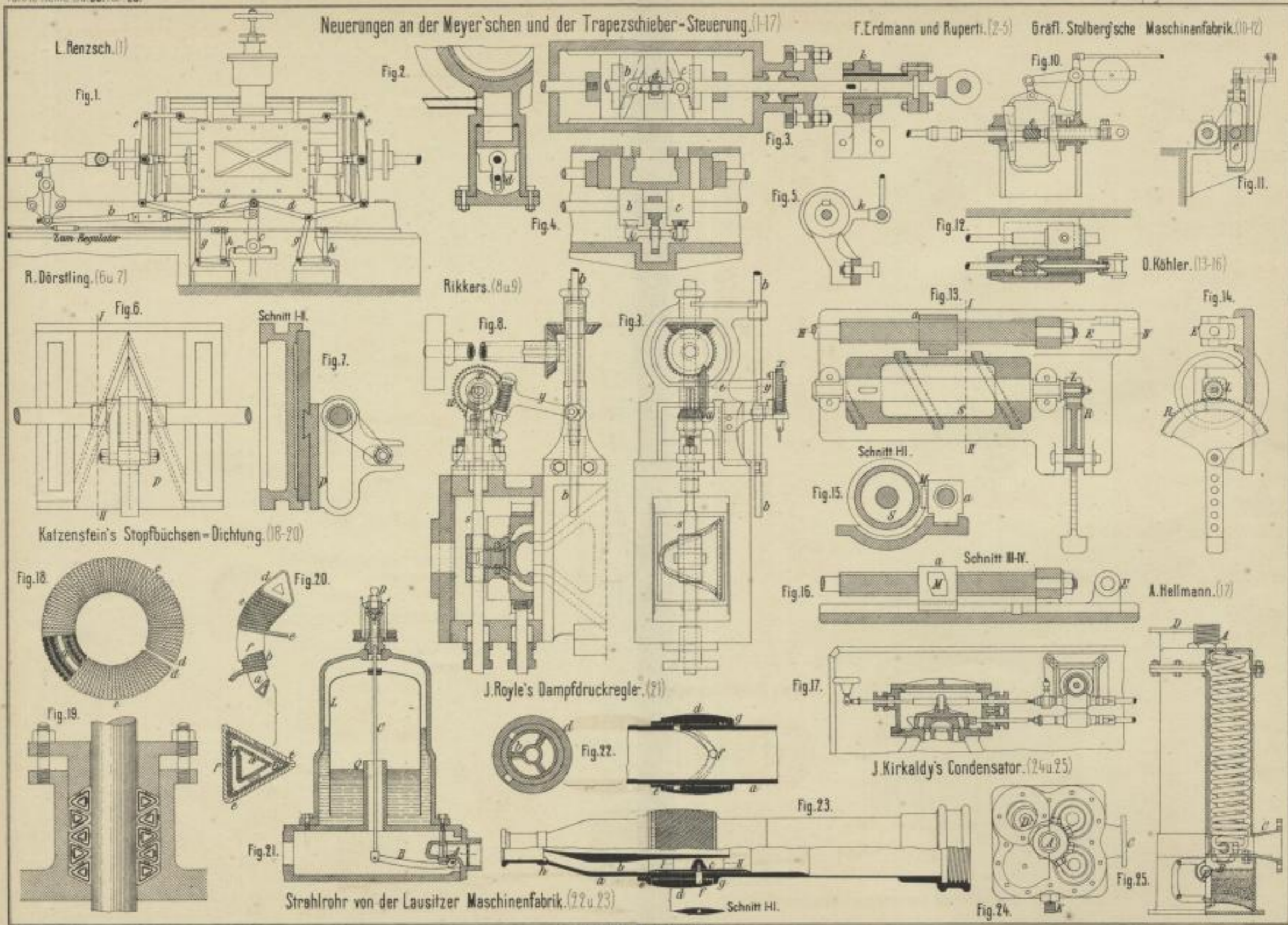

Lith. Anst. v. P. W. v. Darmstadt

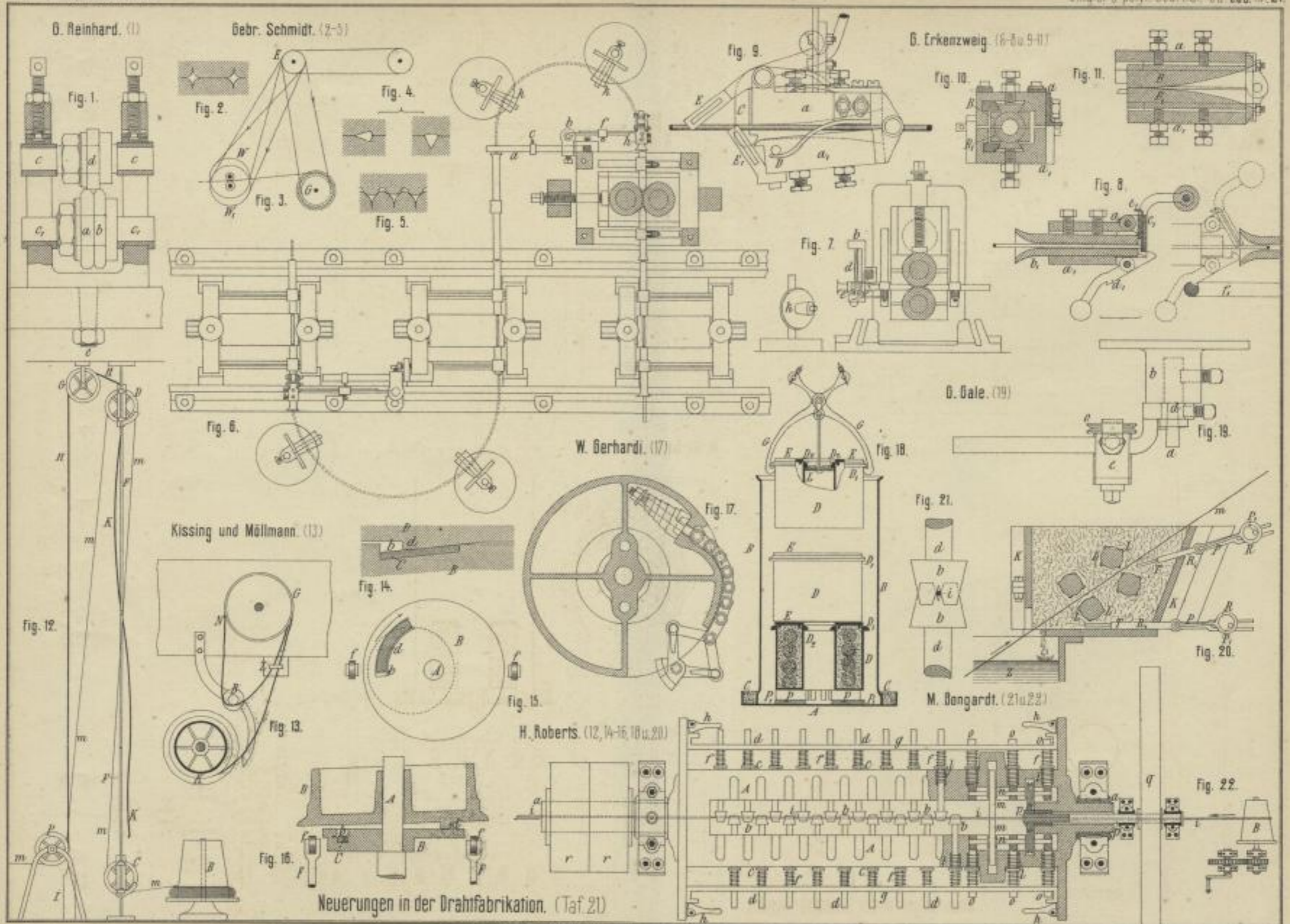

G. Reinhard. (1)

Gebr. Schmidt. (2-5)

G. Erkenzweig. (6-8u. 9-11)

Kissing und Möllmann. (13)

W. Berhardi. (17)

G. Gale. (19)

H. Roberts. (12, 14-16, 18 u. 20)

M. Bongardt. (21 u. 22)

Neuerungen in der Drahtfabrikation. (Taf. 21)

Esth. Anst. v. F. Wirtz, Darmstadt.



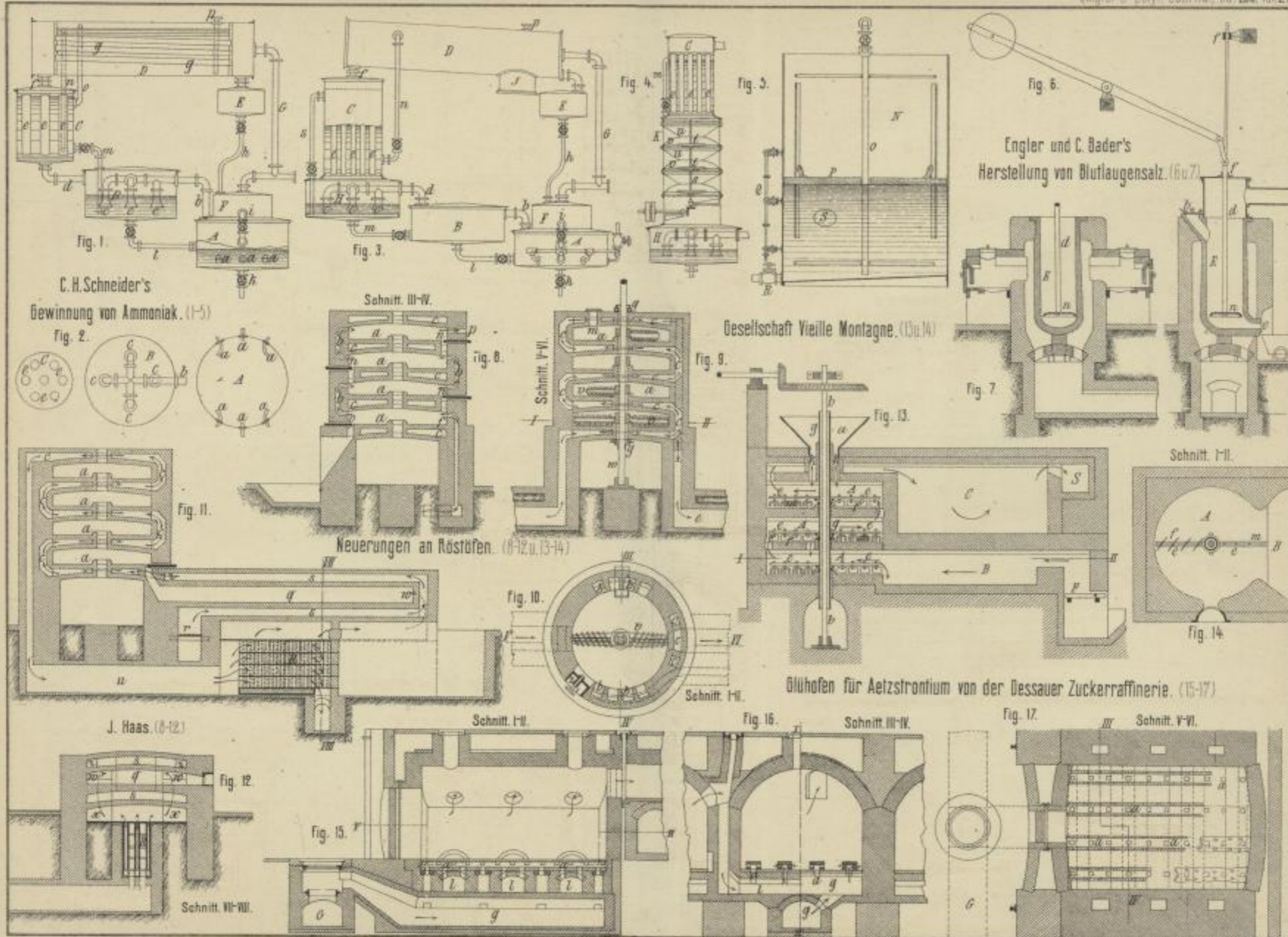

C. H. Schneider's Gewinnung von Ammoniak. (1-5)

Engler und C. Bader's Herstellung von Blutlaugensalz. (6u.7)

Gesellschaft Vieille Montagne. (13u.14)

Neuerungen an Röstöfen. (8-12 u. 13-14)

Blühhofen für Aetzstrontium von der Dessauer Zuckerraffinerie. (15-17)

J. Haas (8-12)

Lith. Anst. v. F. Wirtz, Darmstadt.



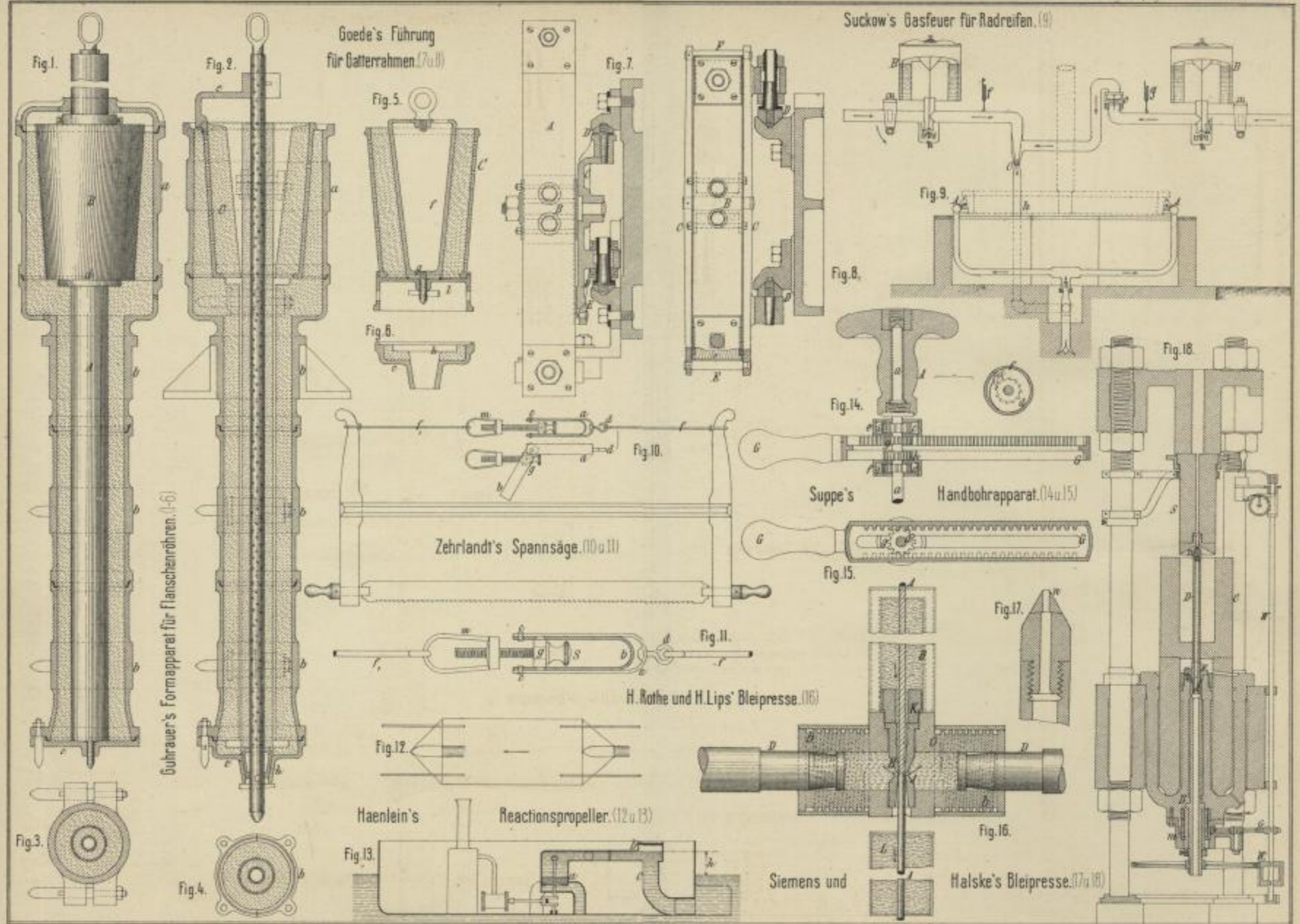

Lith. Anst. v. F. W. v. Darnstadt



Neuerungen im Heizungs- und Lüftungswesen. (1-16)

A. Müller. (1-4 u. 11, 12 u. 13)

H. Ehrhard's Geschwindigkeitsmesser. (17)

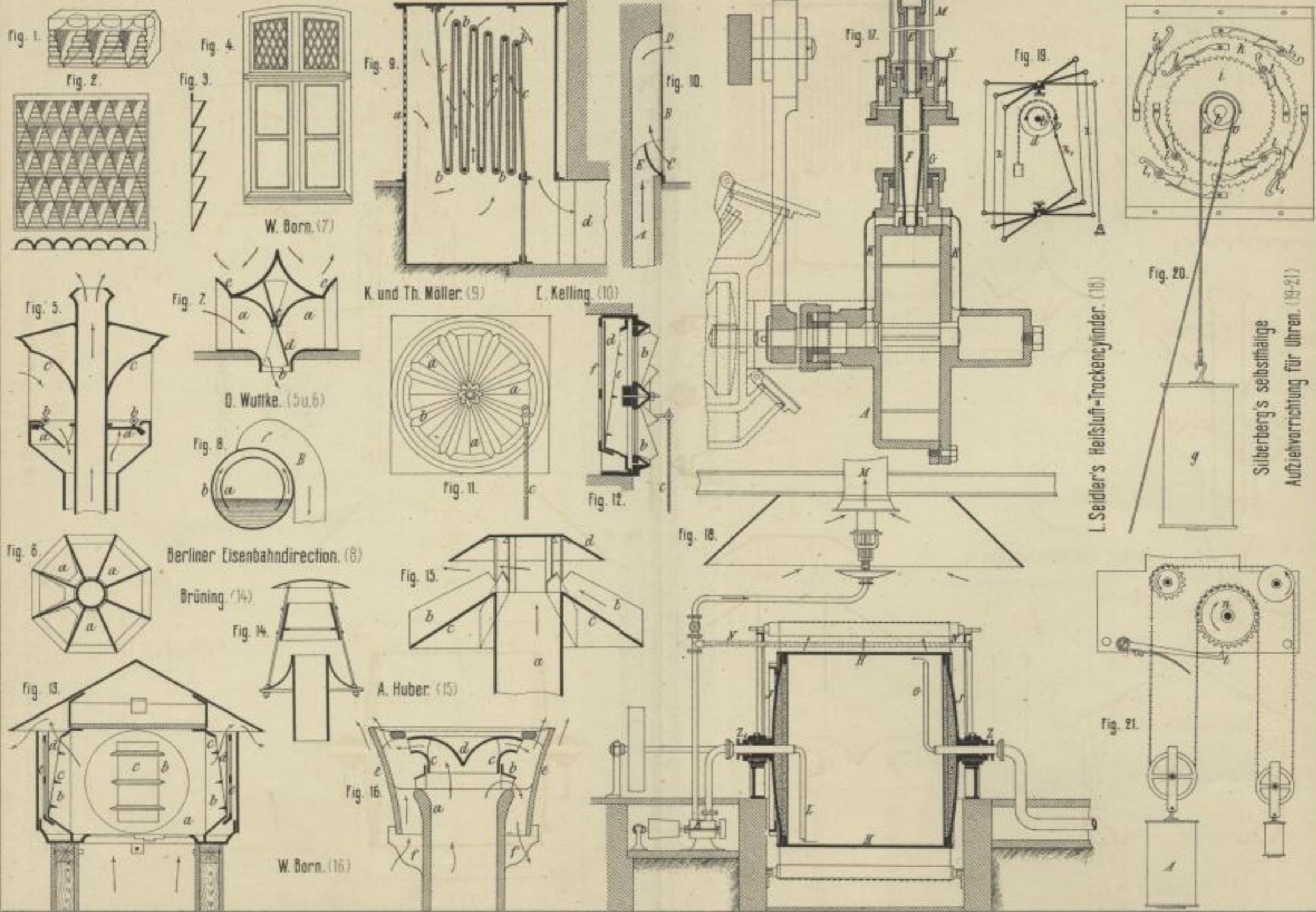

Fig. 1.

Fig. 2.

Fig. 3.

Fig. 4.

W. Born. (7)

Fig. 5.

Fig. 7.

D. Wutke. (5 u. 6)

Fig. 8.

K. und Th. Möller. (9)

E. Kelling. (10)

Fig. 11.

Fig. 12.

Fig. 18.

Fig. 17.

Fig. 19.

Fig. 20.

L. Seidler's Heißluft-Tröckencylinder. (16)

Silberberg's selbsthängende Aufziehvorrichtung für Uhren. (19-21)

Berliner Eisenbahndirection. (3)

Brüning. (14)

A. Huber. (15)

W. Born. (16)

Lith. Anst. v. F. Wirtz, Darmstadt.



Apparate zur Zerlegung von Fetten. (1-5)

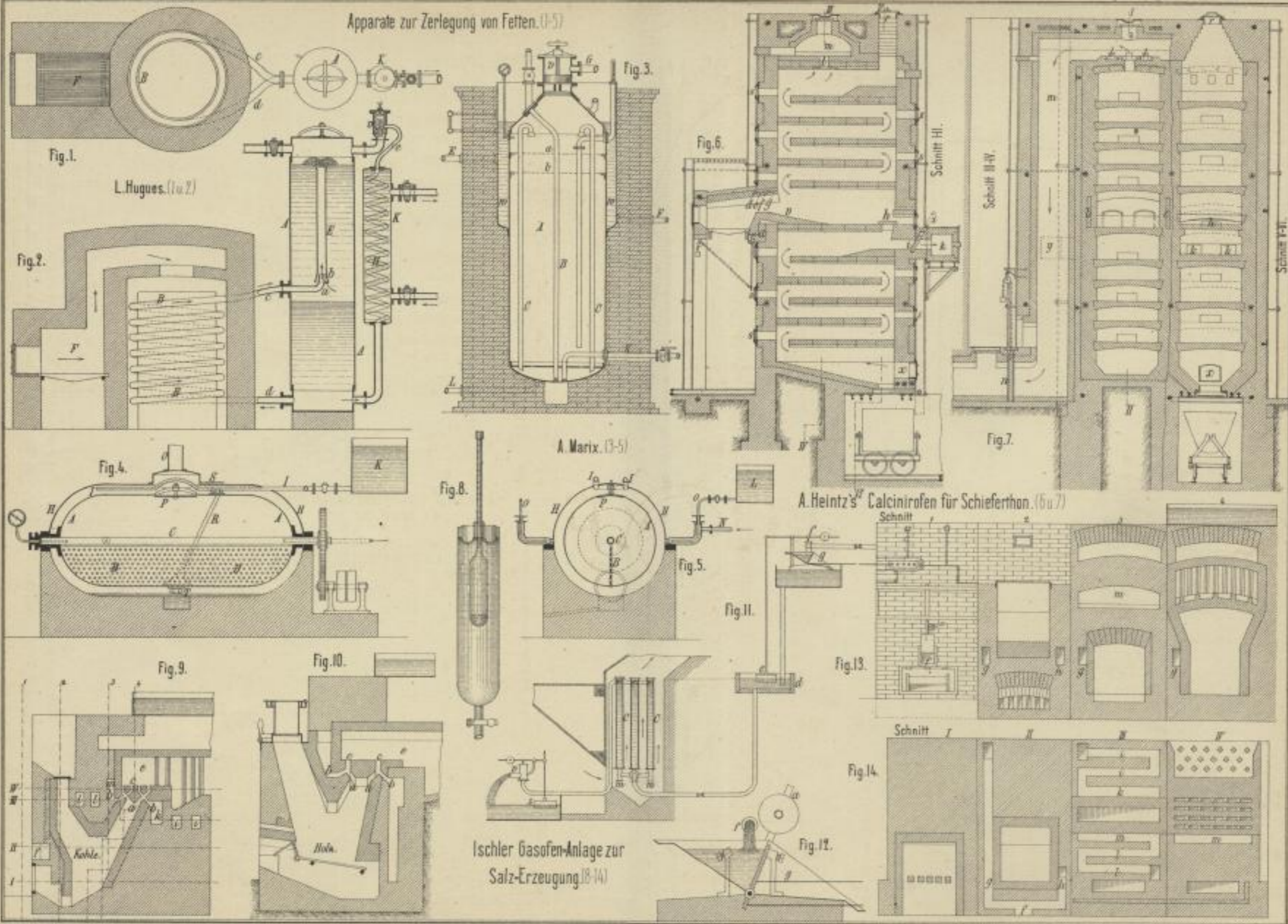

Lith. Anst. v. F. W. W. J. Dörrekecht.



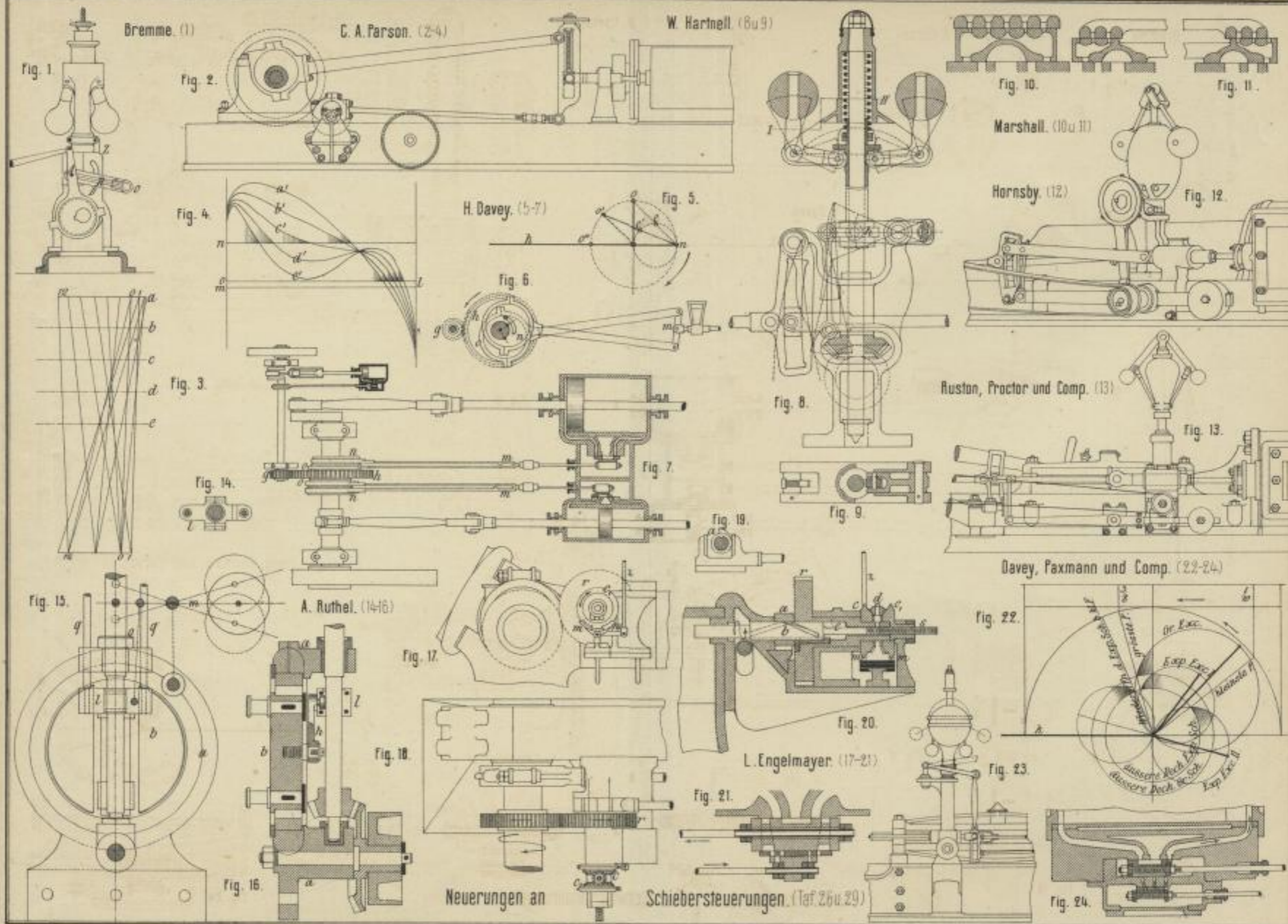

Lucchesini's bez. Estienne's Typendruck-bez. Schreibtelegraph. (1-14 u 15)

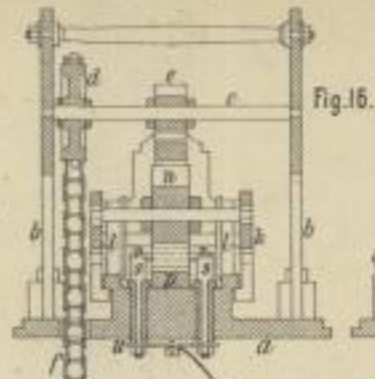
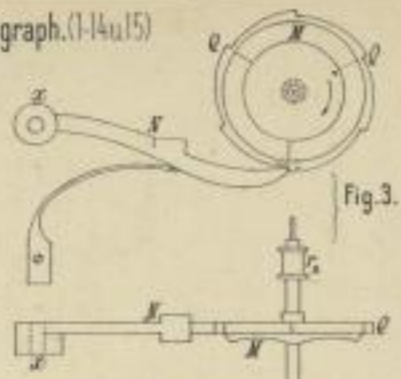
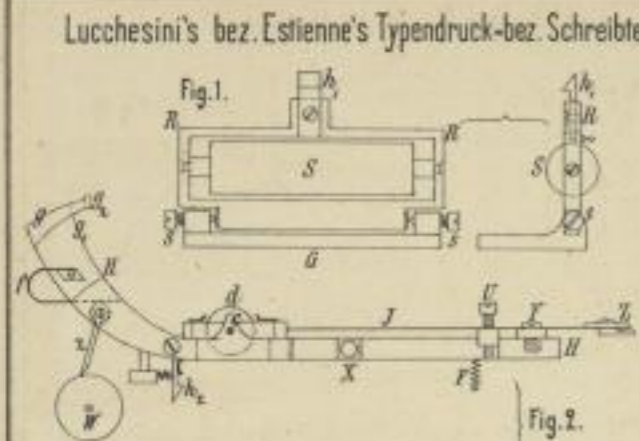

F. May's elektrischer Wasserstandszeiger. (16-18)

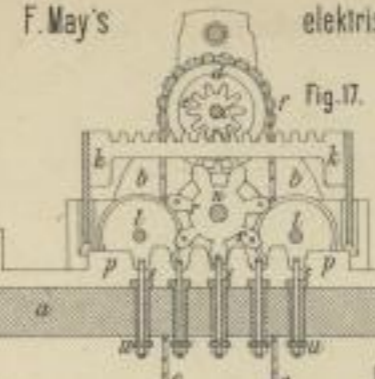

Schüchtermann-Kremer u. Büttgenbach's Etagen-Stromapparat. (19)



De Locht-Labye's Telephon. (20 u 21)

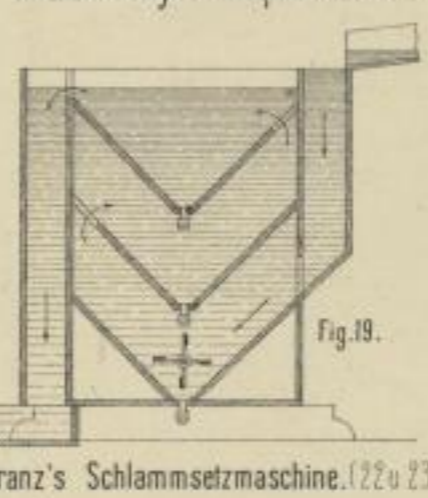

W. Schranz's Schlammsetzmaschine. (22 u 23)

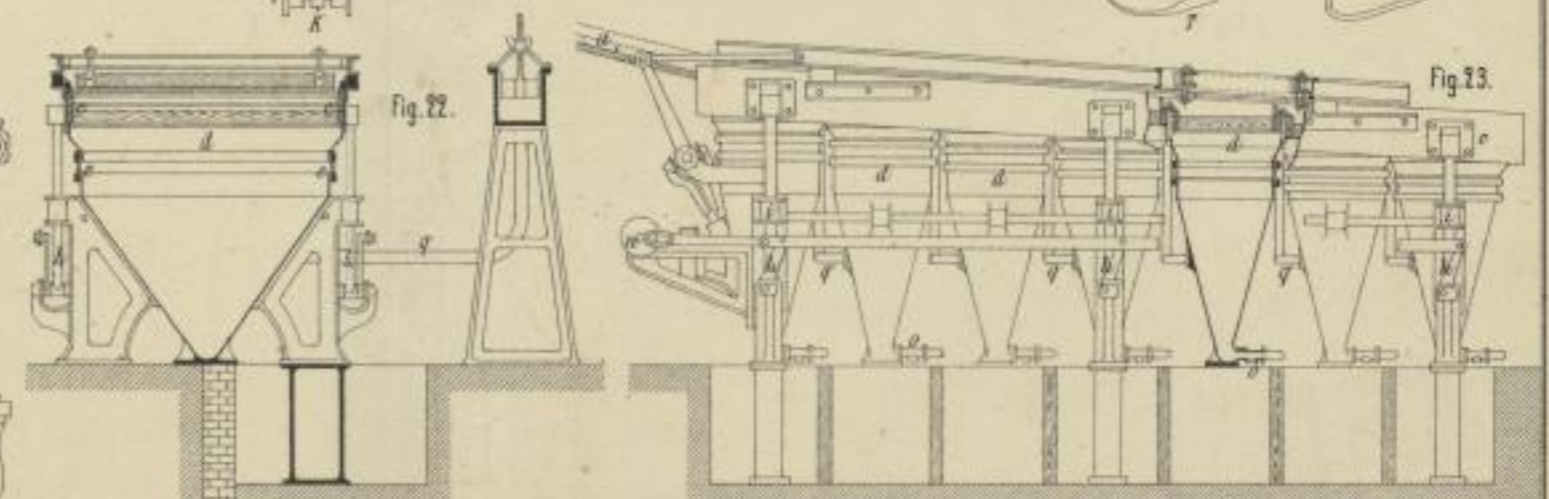

Lith. Anst. v. F. W. Neumann, Neudamm

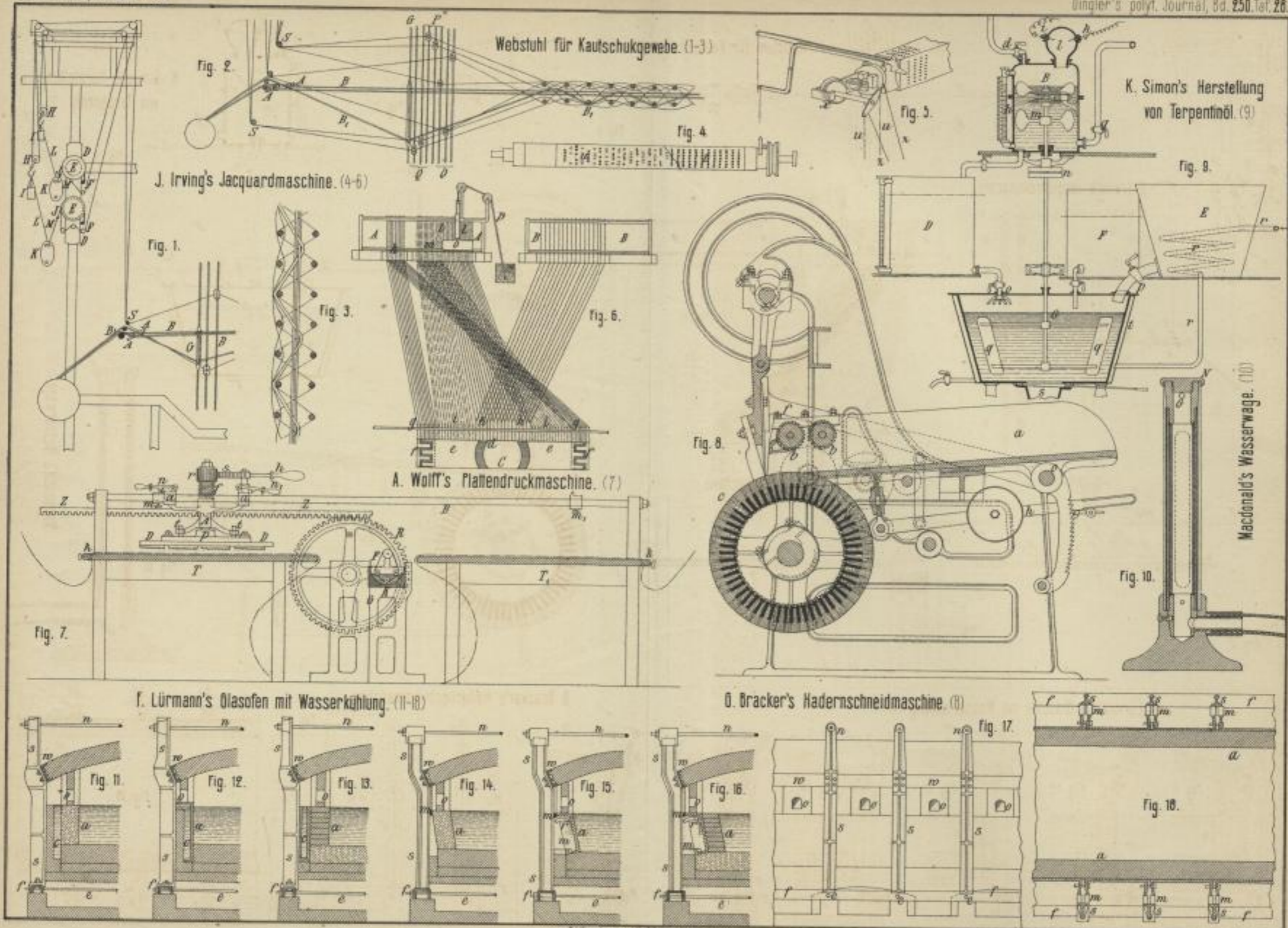

Lith. Anst. v. F. Wirtz, Darmstadt.

Neuerungen an Schiebersteuerungen. (Taf. 26 u. 29)

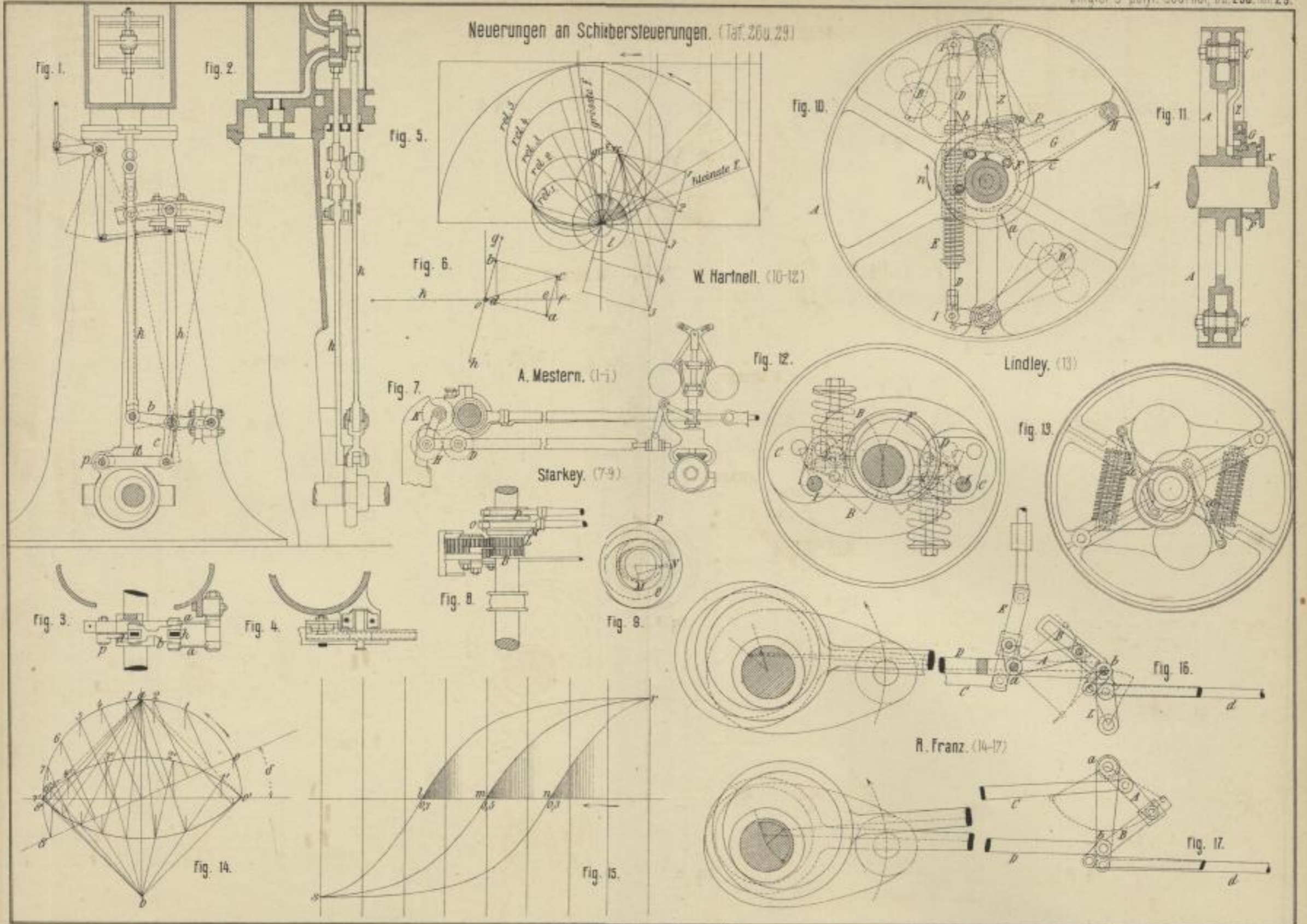

Esch. Anst. v. F. Wirtz, Darmstadt.

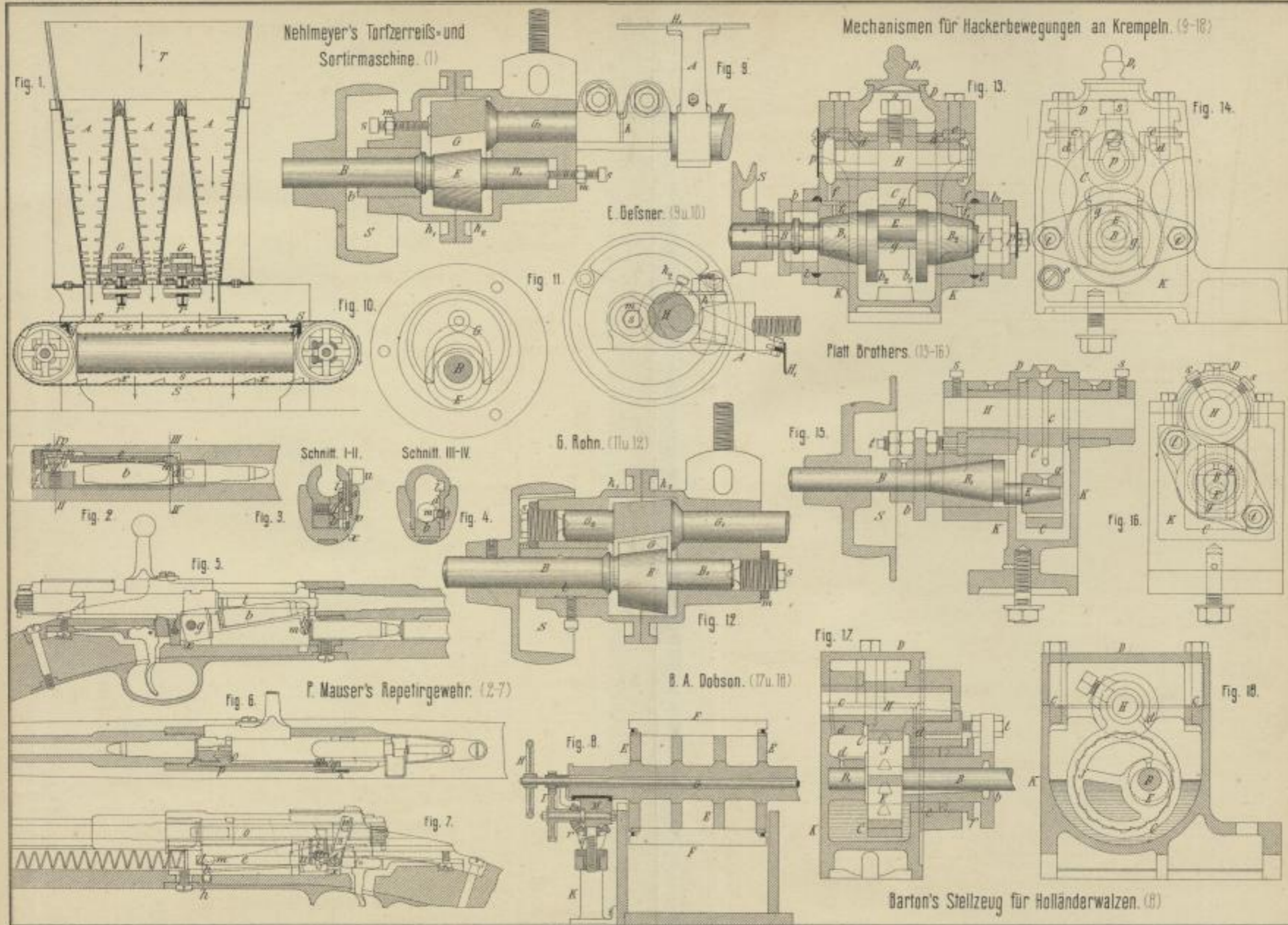

Lich. Anst. v. F. Wörts, Darmstadt.

J. Reinecker's Drehbank für Schneidwerkzeuge. (1-6)

W. Schmidt's Drehbank für Vielkantdrehen. (7-10)

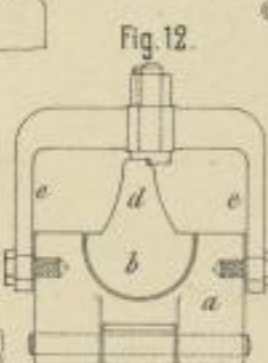
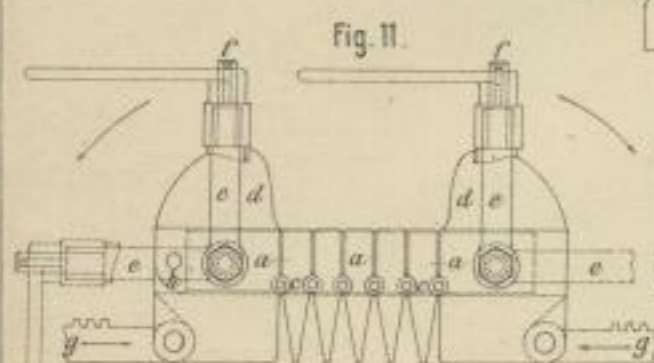
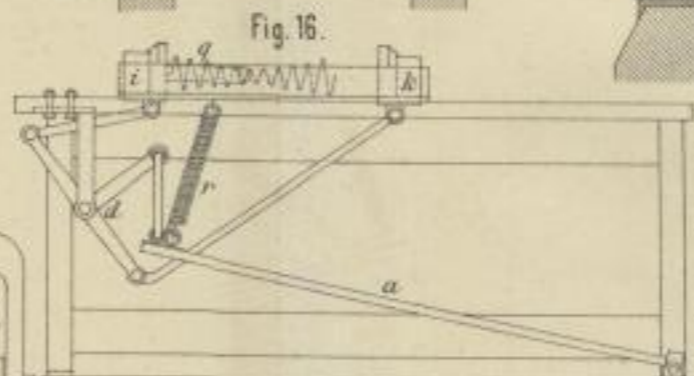
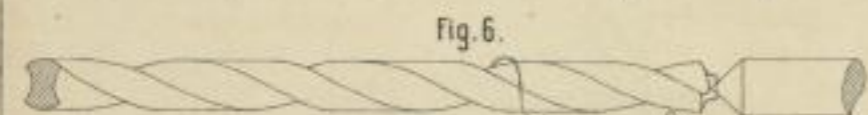
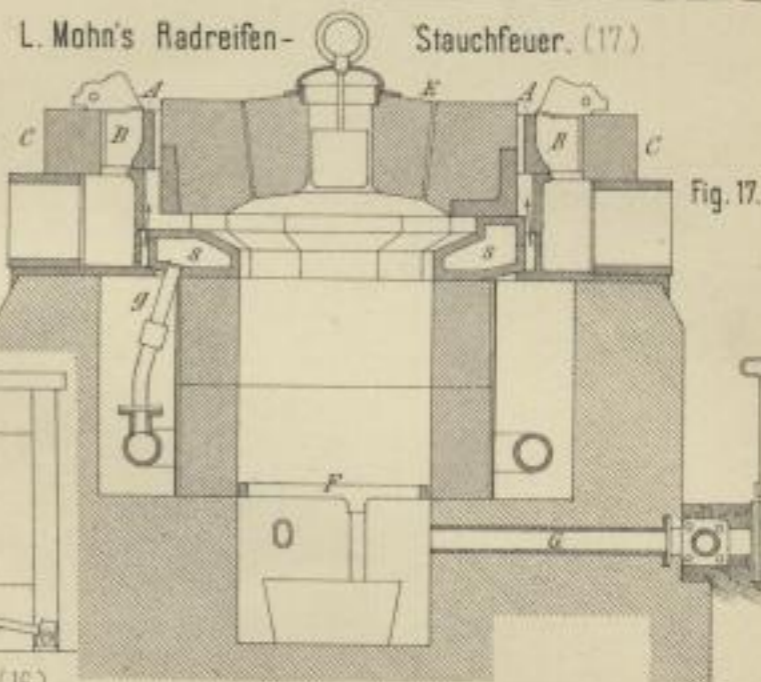
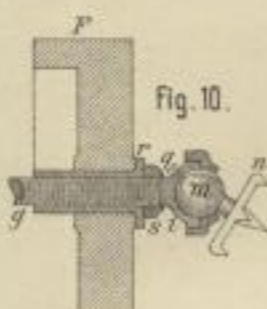
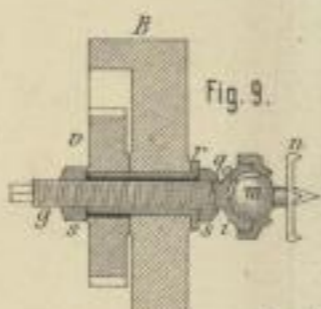
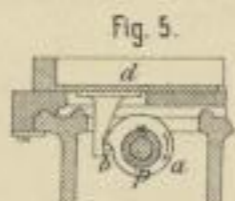
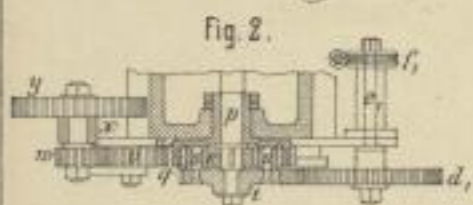
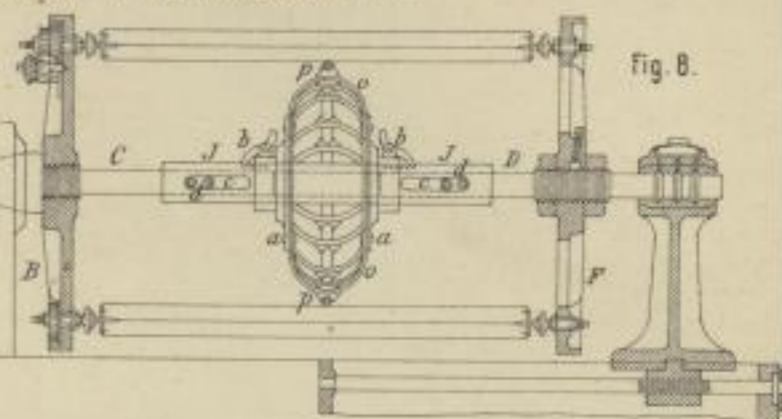
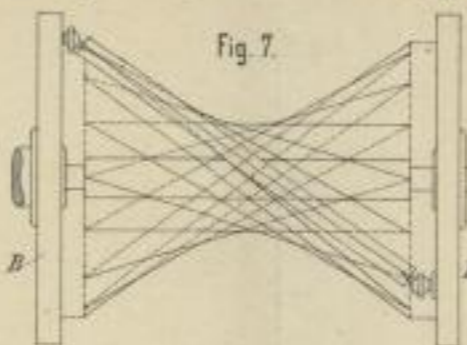
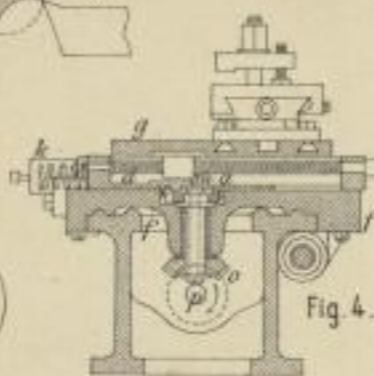
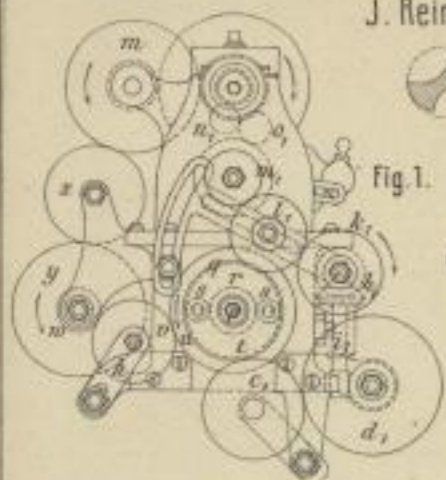

G. Deutgen's Stauchapparat für Springfedern. (16.)

O. Röber's Seifen-Formmaschine. (18-21.)

H. Bertram's Herstellung von Knieröhren. (11-15)

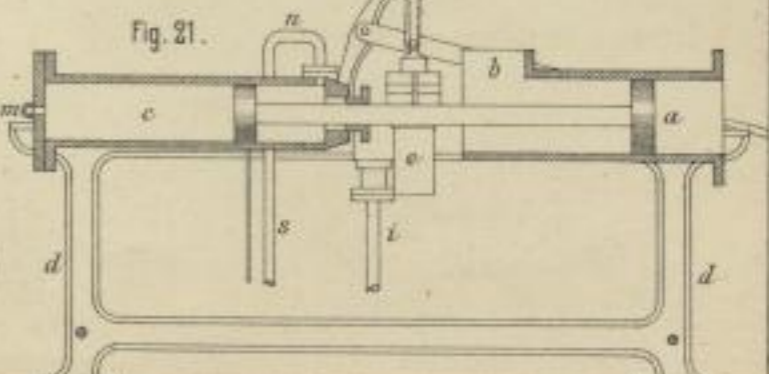
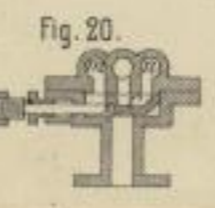
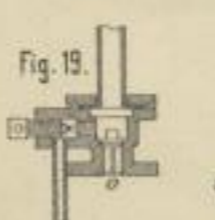
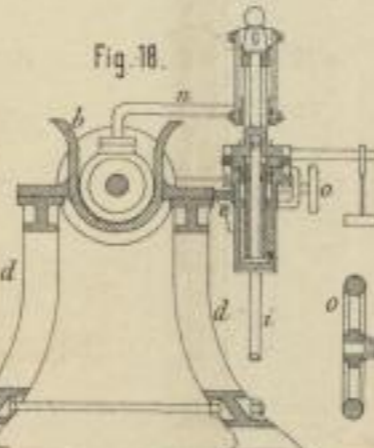
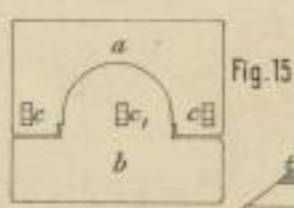
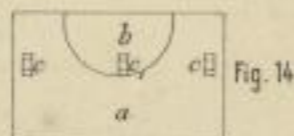
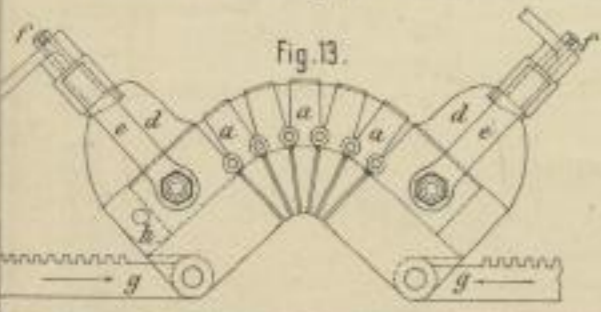

Lith. Anst. v. T. Witt, Darmstadt.



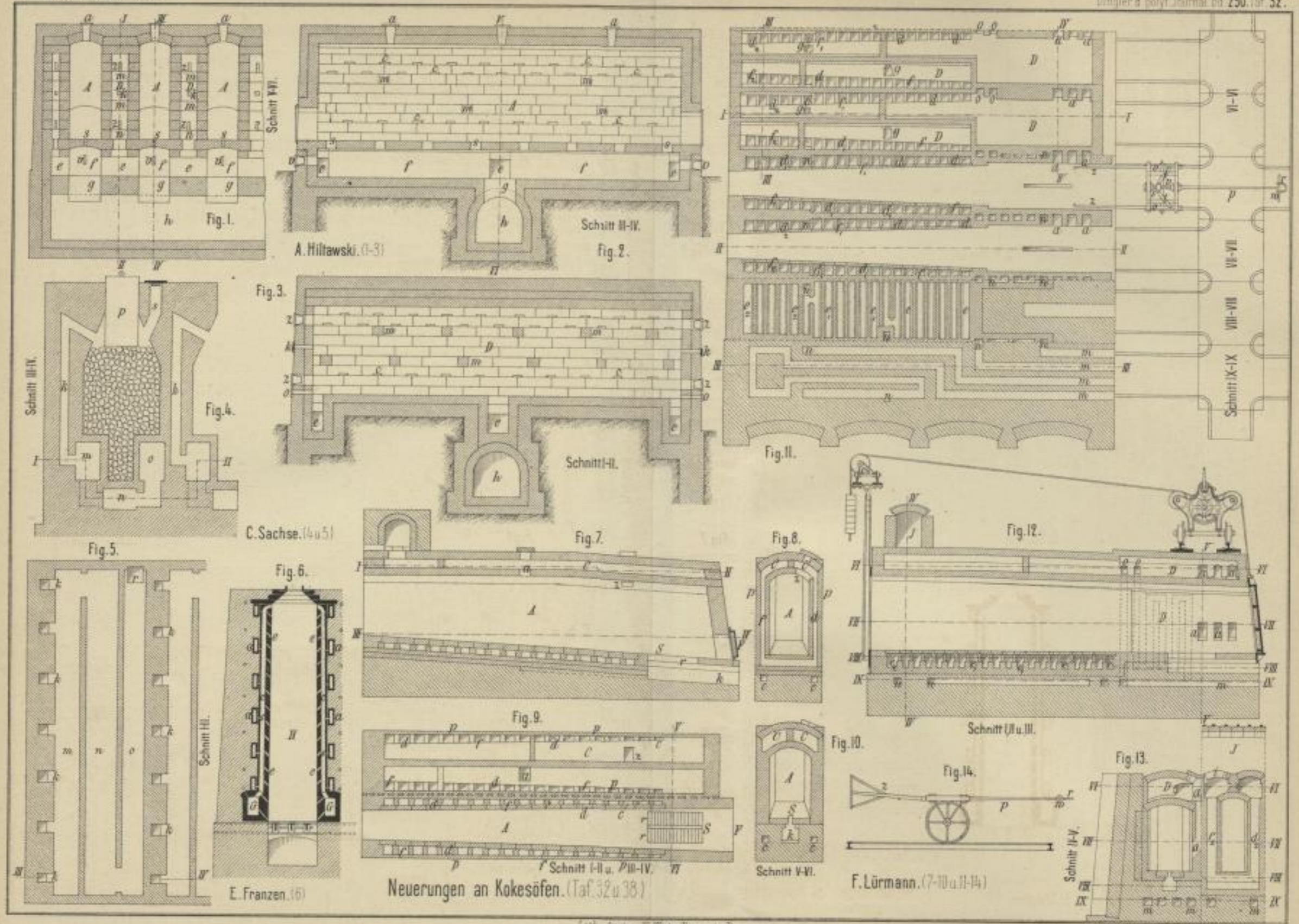

Lith. Anst. v. F. W. Farnstätt

Friedr. Kick: Neuerungen im Mühlenwesen. (Taf. 17 u. 33)

A. Putz. (1 u. 2)

Ganz und Comp. (6-8)

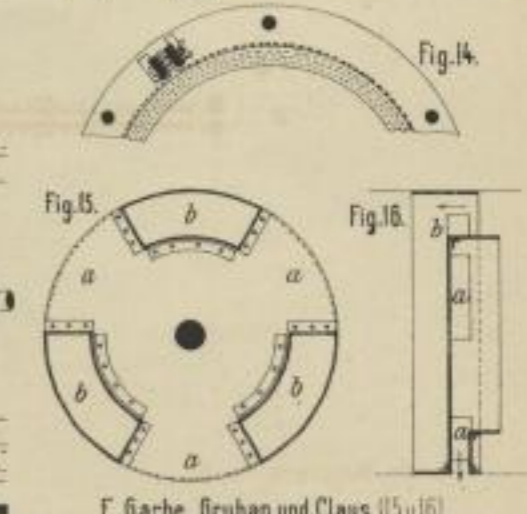
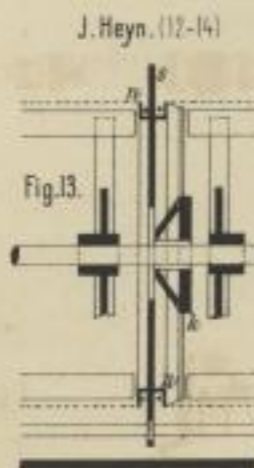
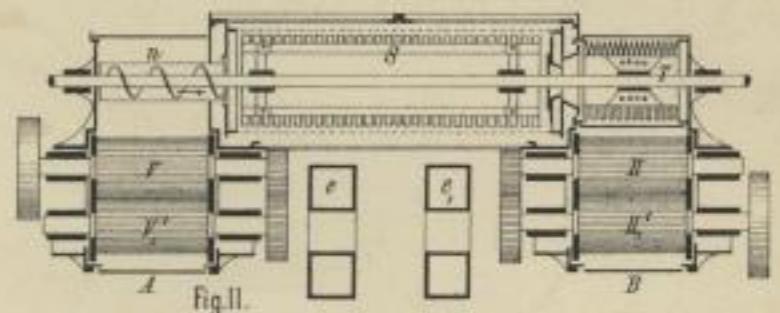
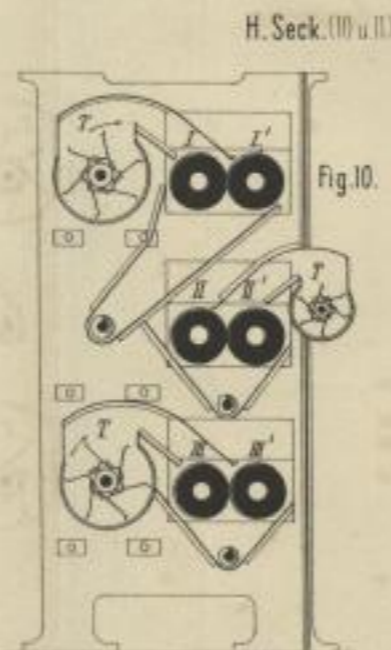
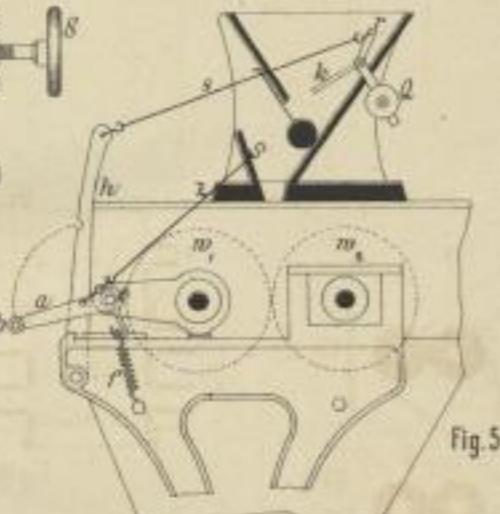
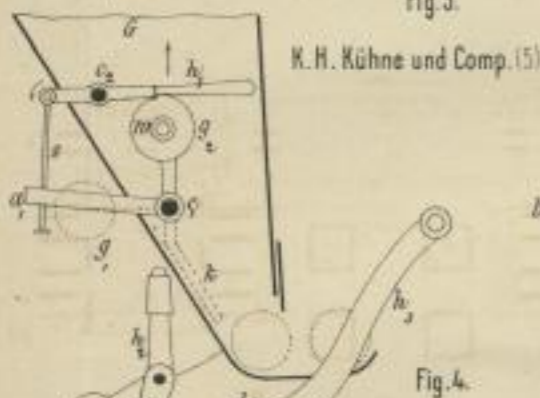
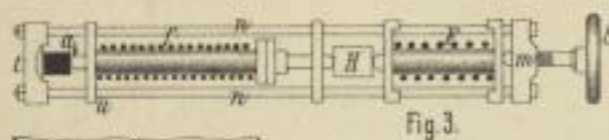
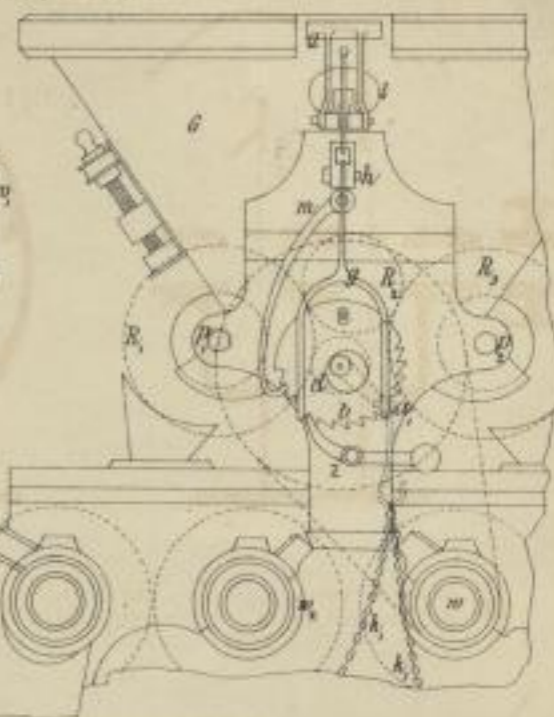
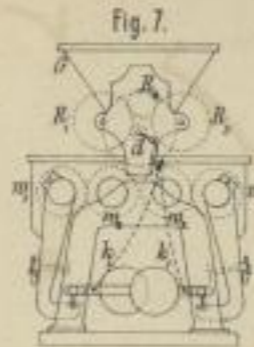
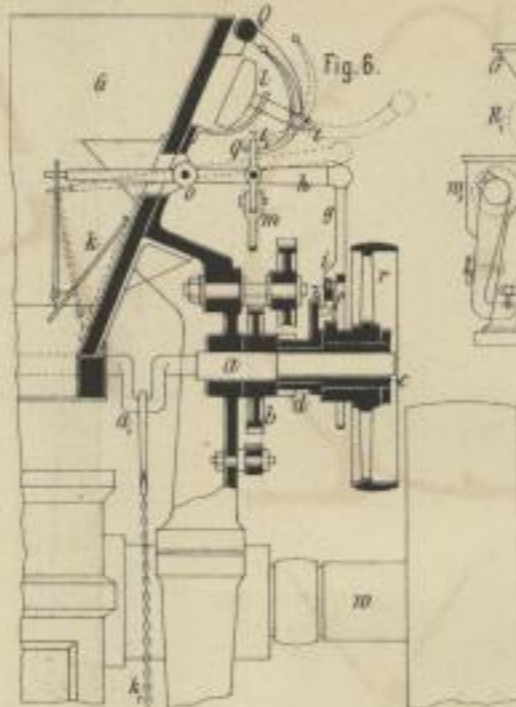
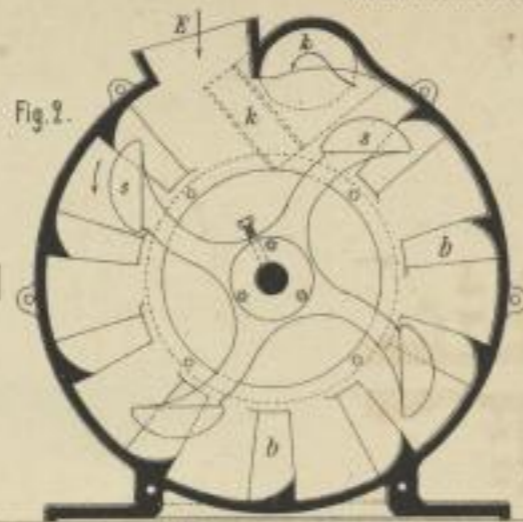
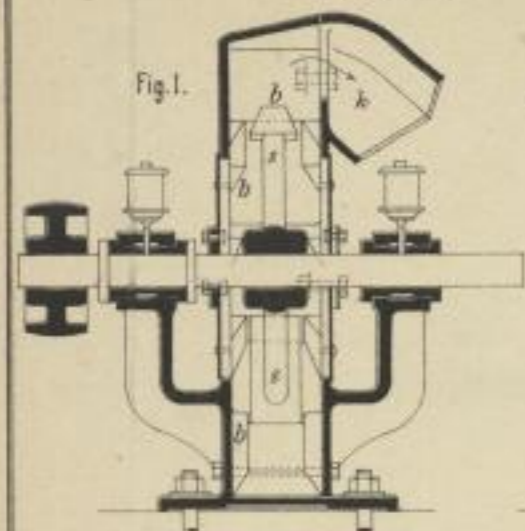

Fr. Wegmann. (3 u. 4)

K. H. Kühne und Comp. (5)

H. Seck. (10 u. 11)

J. Heyn. (12-14)

G. Luther. (9)

E. Garbe, Gruban und Claus. (15 u. 16)

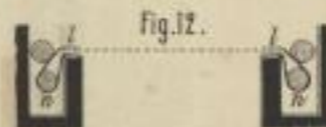
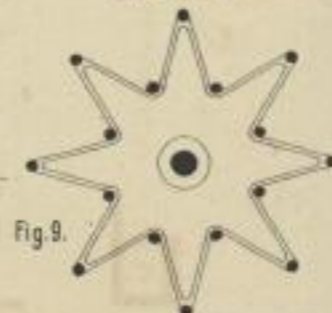

Lith. Anst. v. F. Wirtz Darmstadt



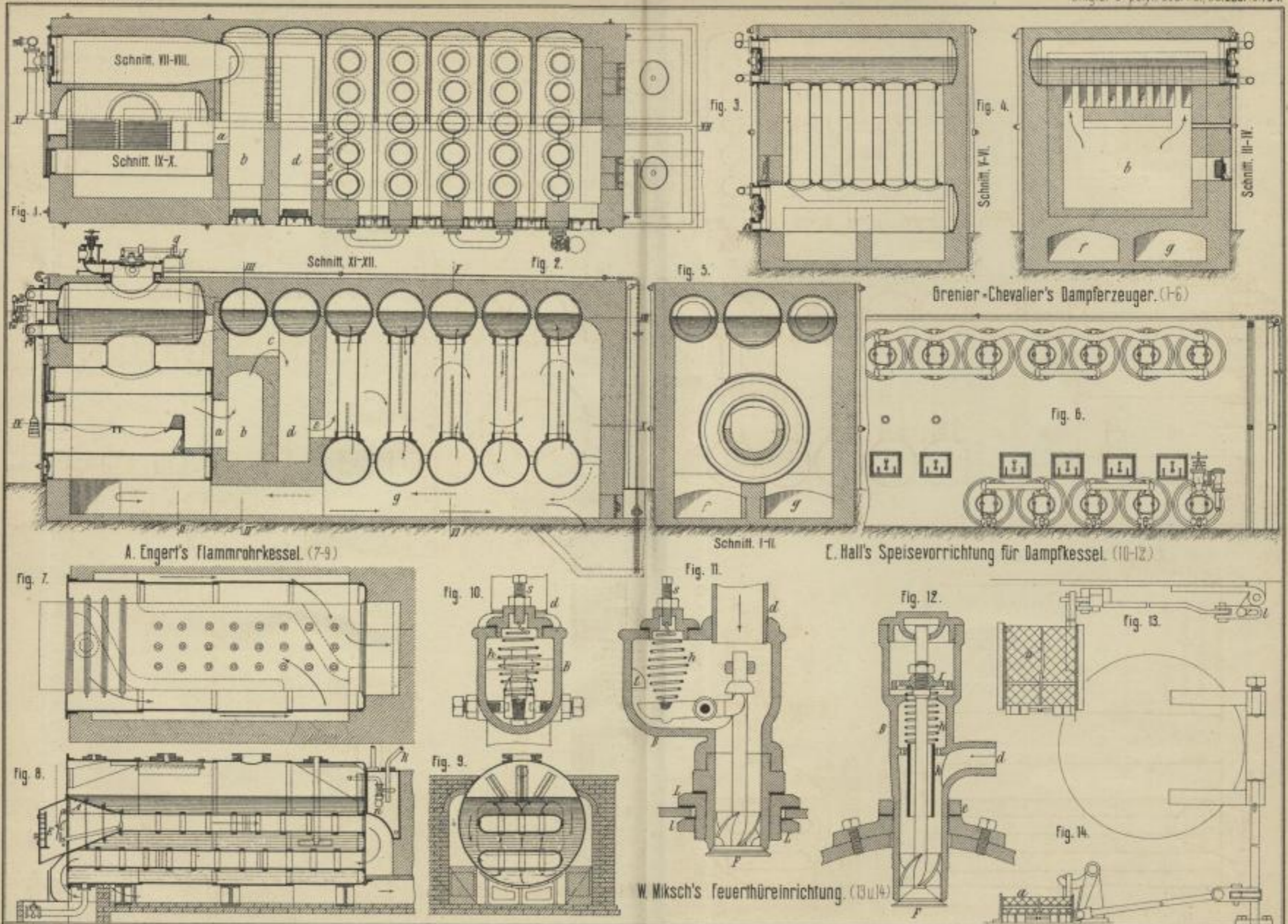

Lith. Anst. v. P. Wirtz, Jarmstadt.

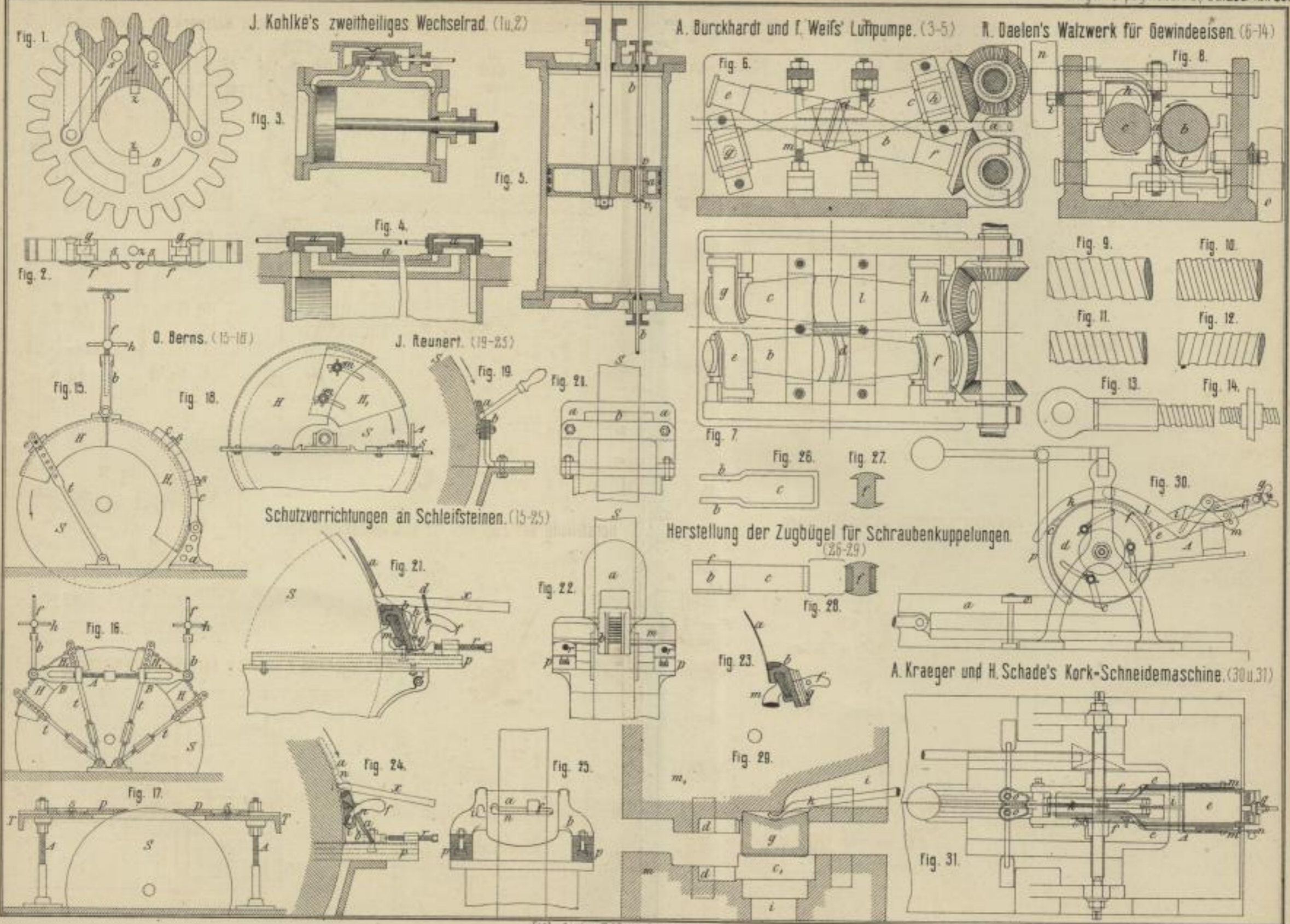

Lith. Anst. v. F. W. Metz, Darmstadt.



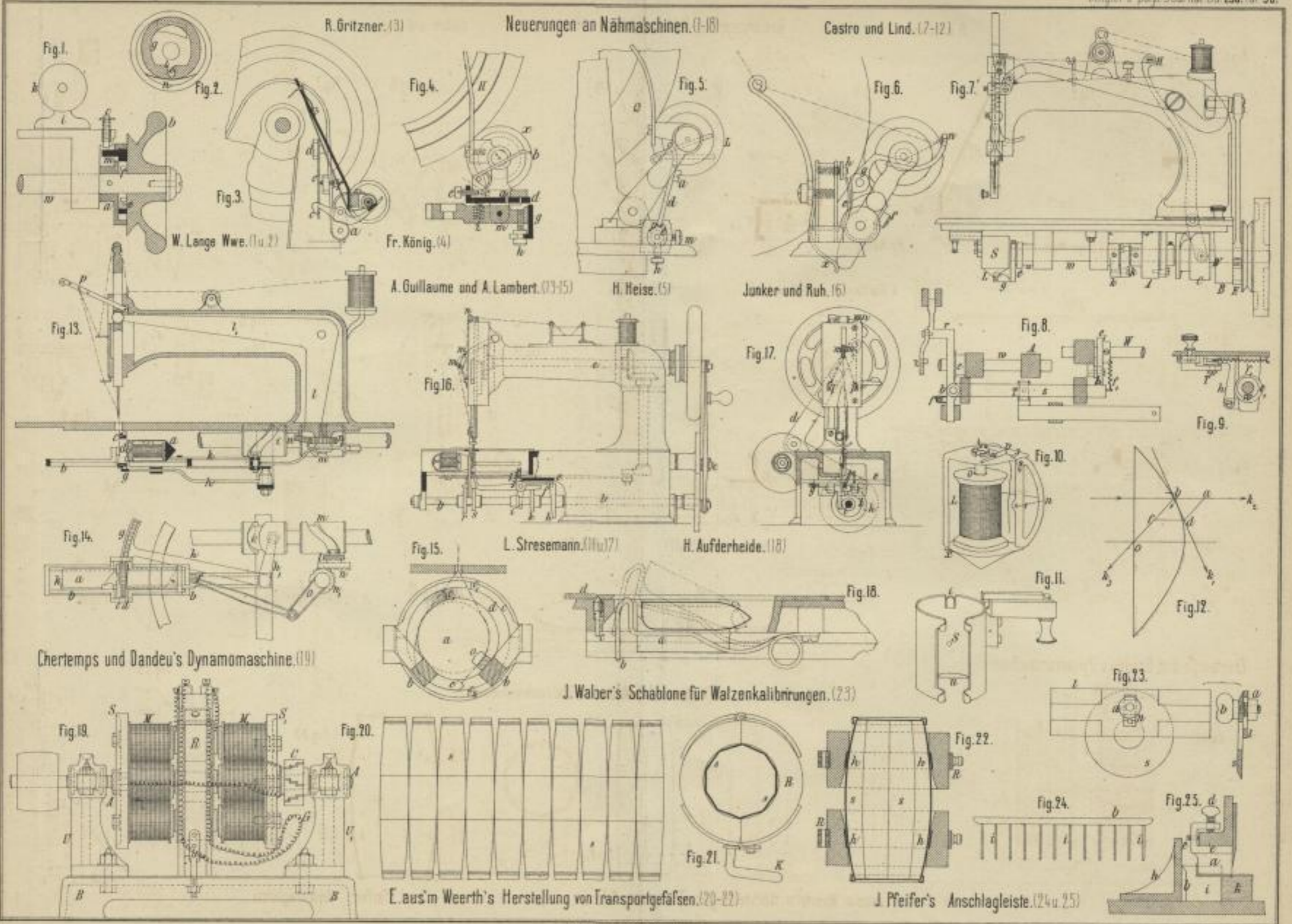

Lith. aus d. P. Witt's Werkstatt

Maggi's Typen-Schreibmaschine. (1-6.)

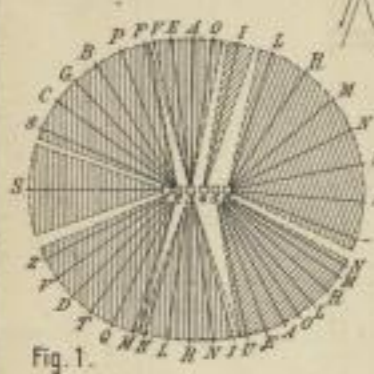

Fig. 1.



Fig. 2.

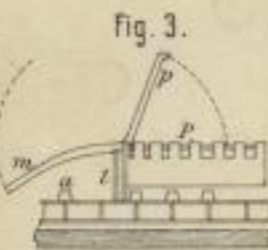

Fig. 3.

Fig. 4.



Dietsch's Cementofen mit Vorwärmer. (9-13.)



Fig. 5.

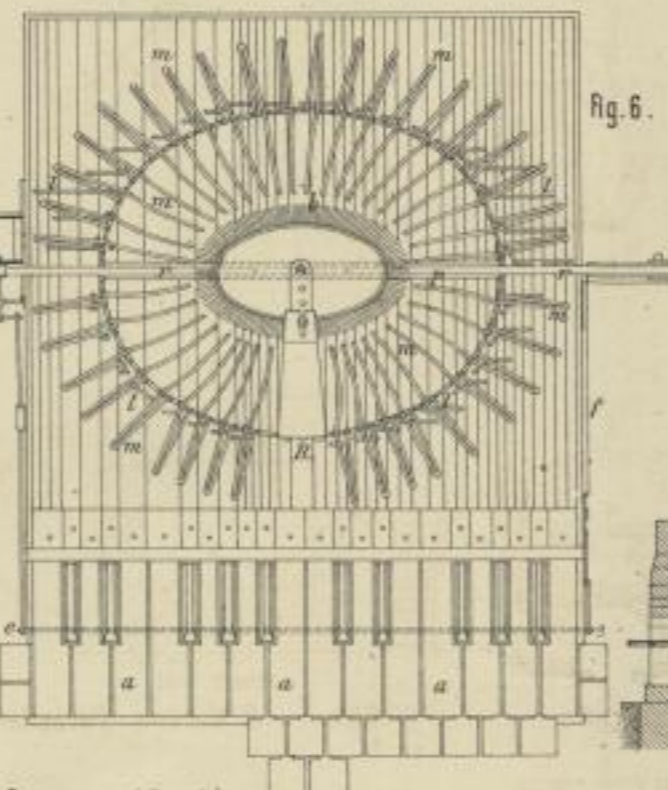

Fig. 6.

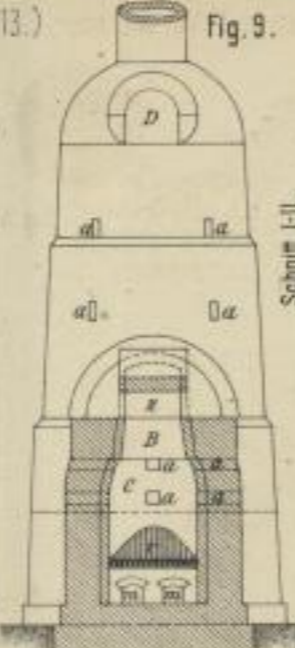

Fig. 9.

Schnitt I-II.

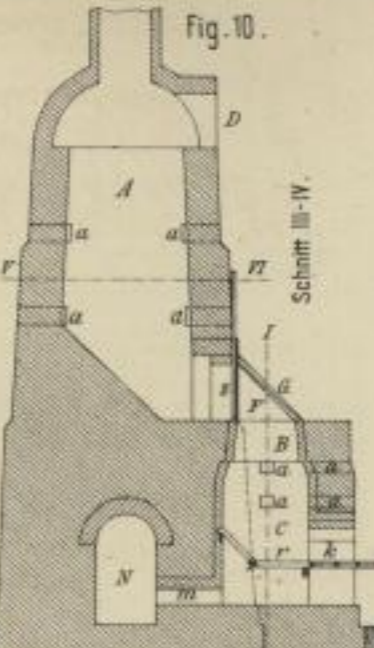

Fig. 10.

Schnitt III-IV.

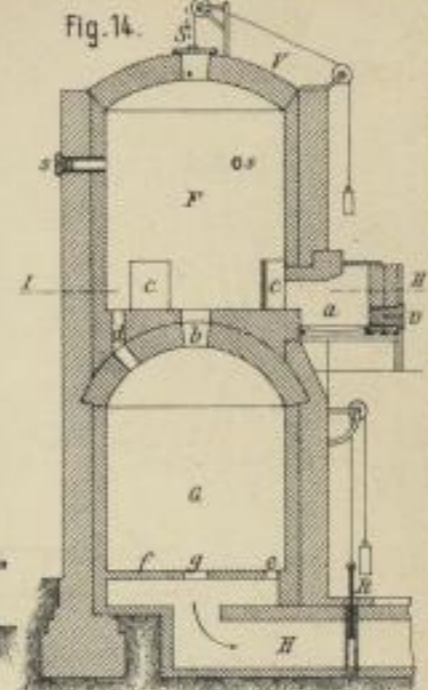

Fig. 14.

Schnitt I-II.

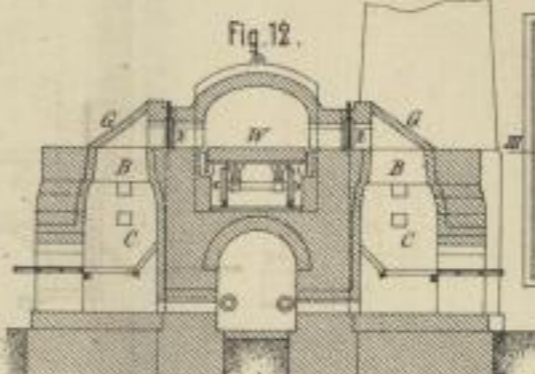
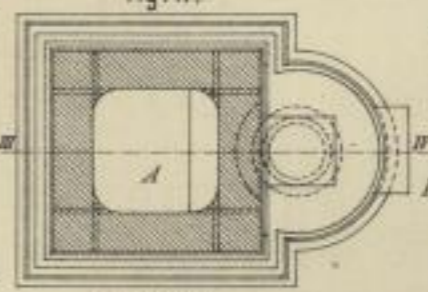

Fig. 12.

Schnitt V-VI.



Schnitt V-VI.

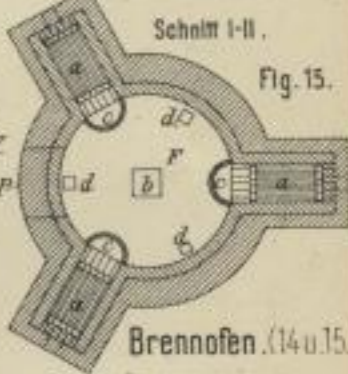

Fig. 15.

Schnitt I-II.

A. Bernard's Eindampfapparat. (7 u. 8.)

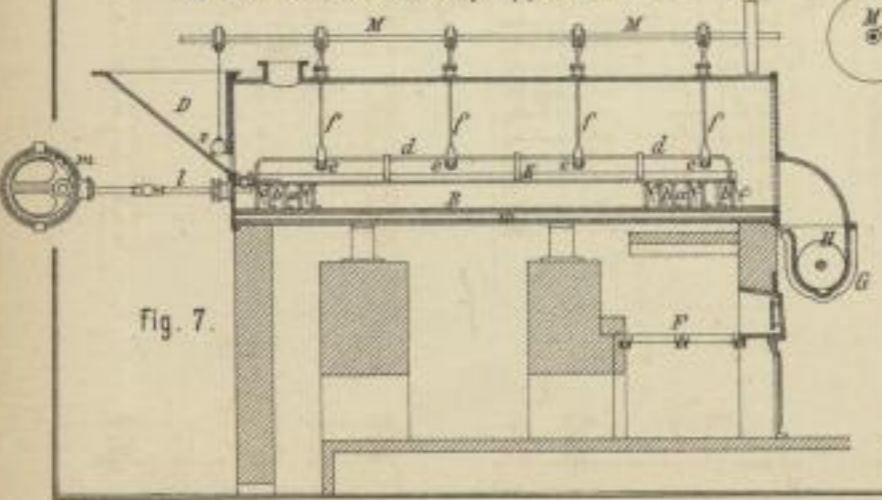

Fig. 7.

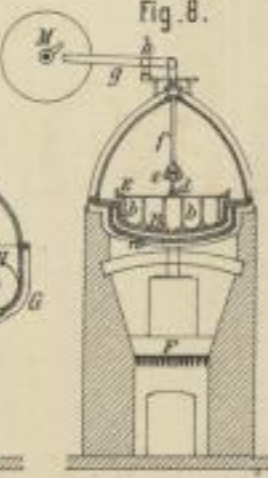

Fig. 8.

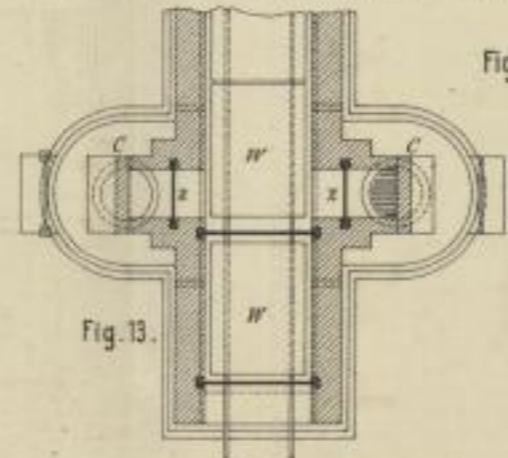

Fig. 13.

Martens' elektrotechnische Prüfung der Metalle. (16-19.)

Fig. 16.

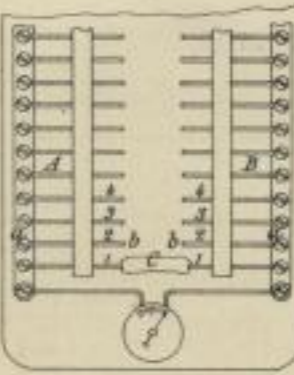

Fig. 18.



Fig. 17.

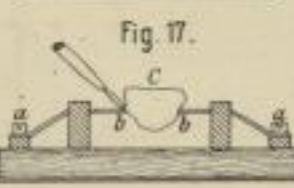
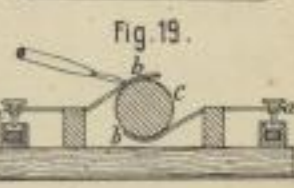
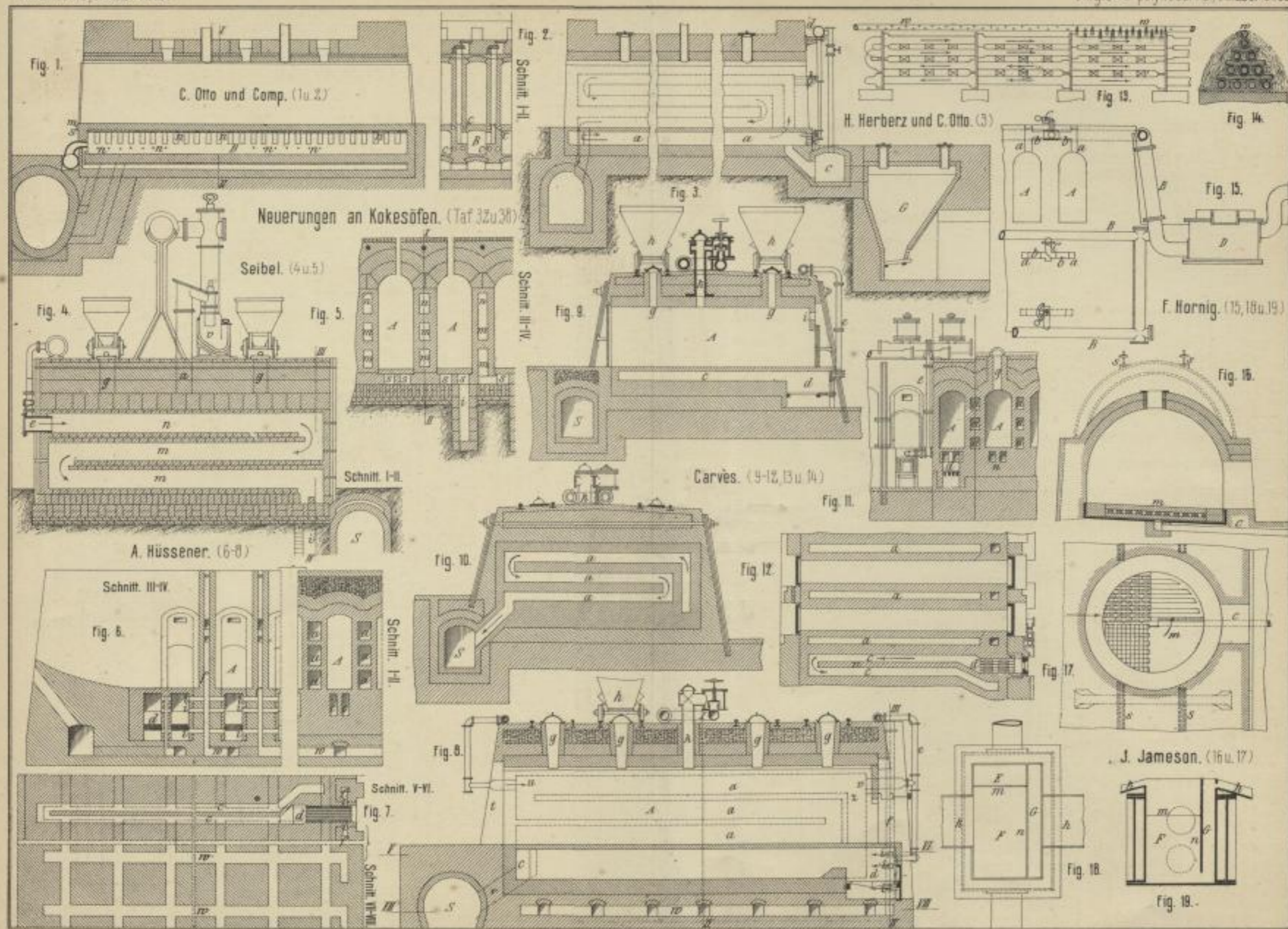

Fig. 19.



Lehr. Buch v. F. W. W. Zimmernach











MA WIZENHAUSEN  
Buchbinderei  
1885



SLUB DRESDEN



3 2422827