













# Atlas

zu

## Dingler's polytechnischem Journal.

Band 251.

(Fünfundsechzigster Jahrgang.)

Jahrgang 1884.

---

Enthaltend 39 lithographirte Tafeln.



Stuttgart.

Verlag der J. G. COTTA'schen Buchhandlung.

06913

Atlas

Jungfer's polytechnisches Journal

Band 251

(Fünfundsechzigster Jahrgang)

Jahrgang 1884

Entwurf von J. G. Lehmann



1884



Sächsische  
Landesbibliothek  
Dresden

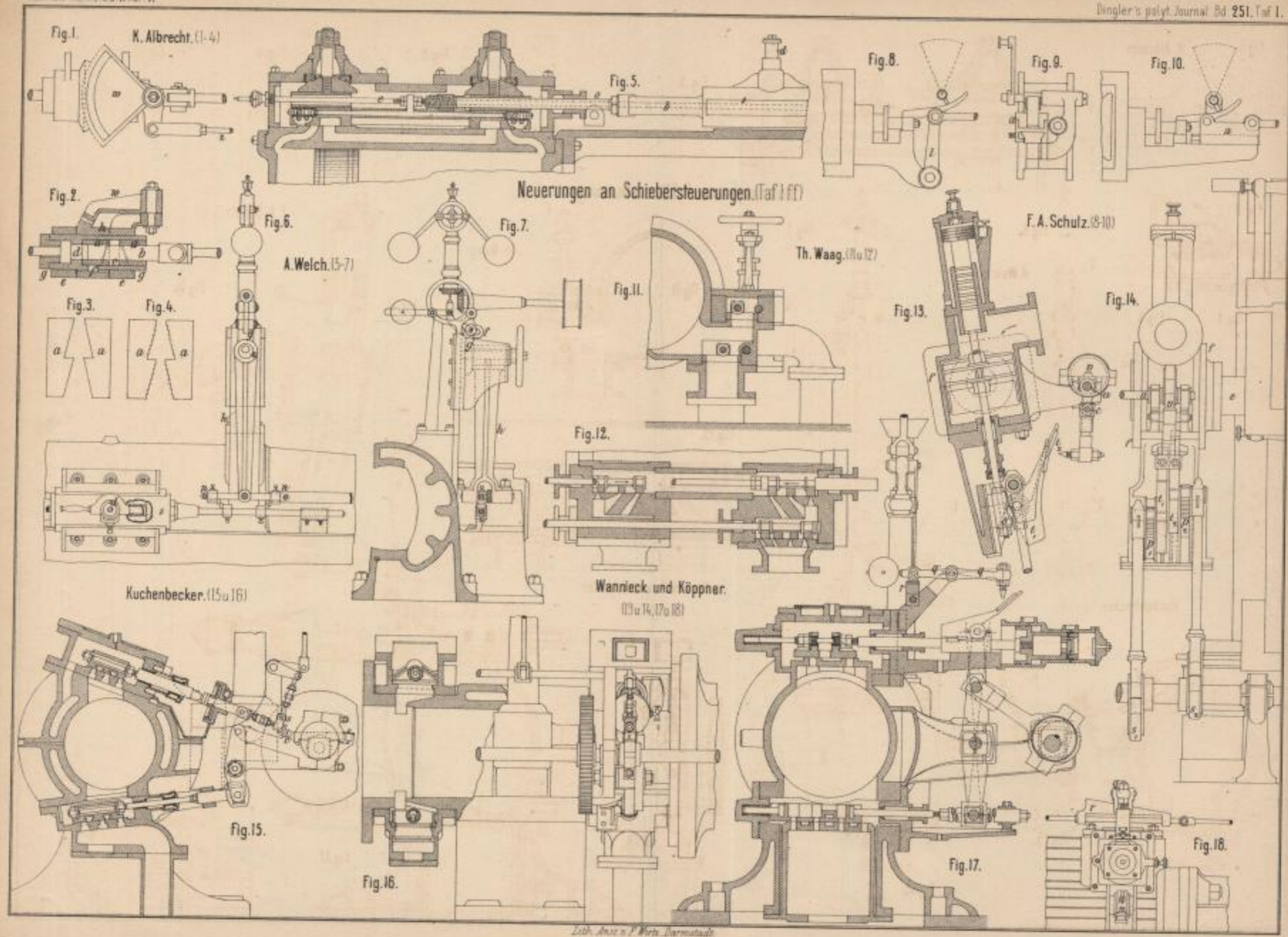

Neuerungen an Schiebersteuerungen (Taf. I ff)

Kuchenbecker. (15 u 16)

Wannick und Köpner. (13 u 14, 17 u 18)

Th. Waag. (11 u 12)

F. A. Schulz. (8-10)

Lith. Anst. v. F. W. Meyer, Darmstadt

Suckow's rotirender Gasmotor. (1u.2)

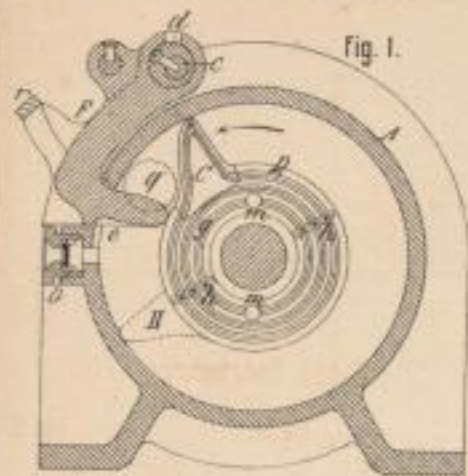

Fig. 1.

Jaacks und Behrns' Becherwerk. (3)

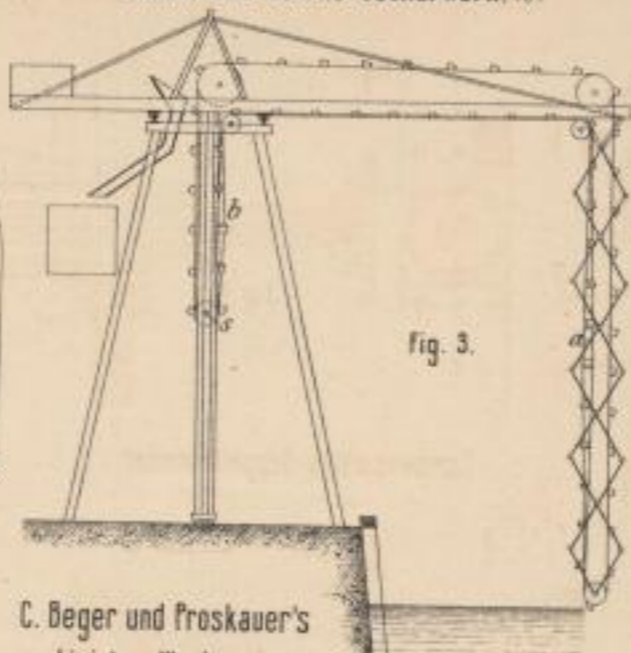

Fig. 3.

G. Canet's hydraulischer Buffer. (7u.8)

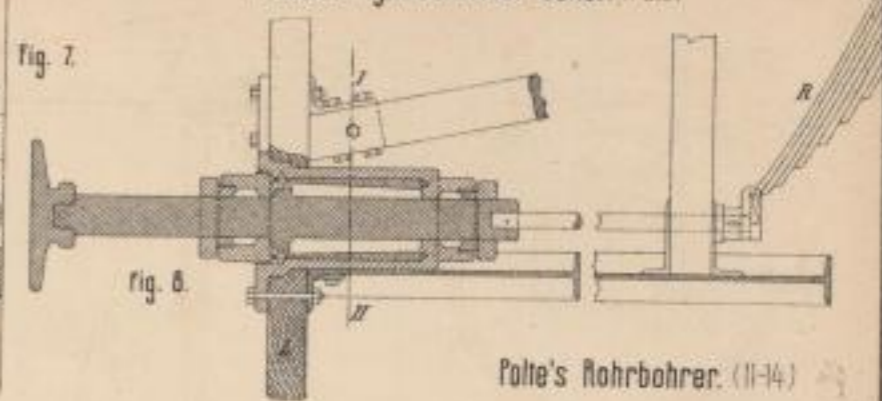

Fig. 7.

Fig. 8.

C. Beger und Proskauer's combinirtes Werkzeug. (4)

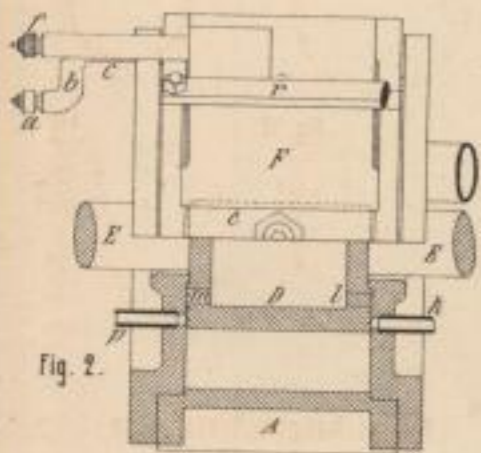

Fig. 2.

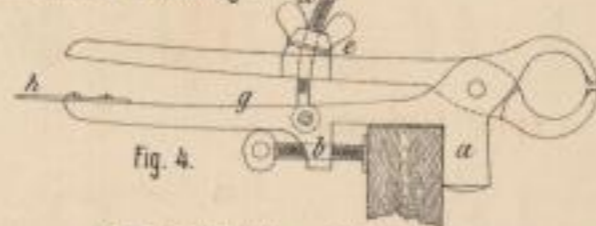

Fig. 4.

Compensations-Doppelkrümmer. (5u.6)

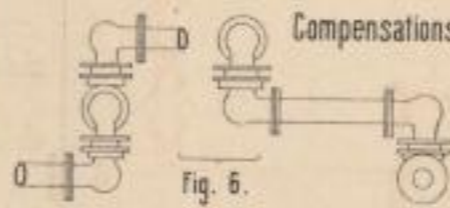

Fig. 5.

Fig. 6.

Potte's Rohrbohrer. (11-14)

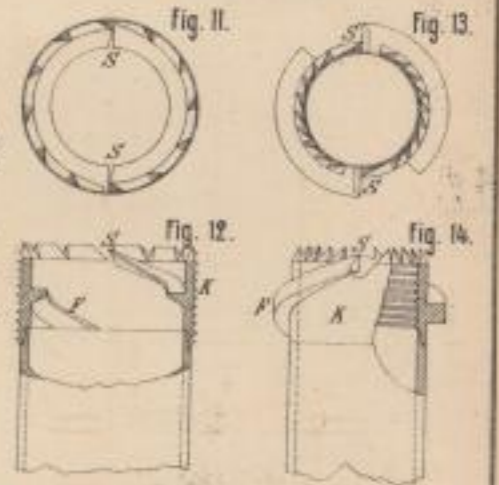

Fig. 11.

Fig. 13.

Fig. 12.

Fig. 14.

Kalker Bohrknarre. (9u.10)



Fig. 9.

Fig. 10.

D. Frisbie's lösbare Reibungskuppelung. (18)

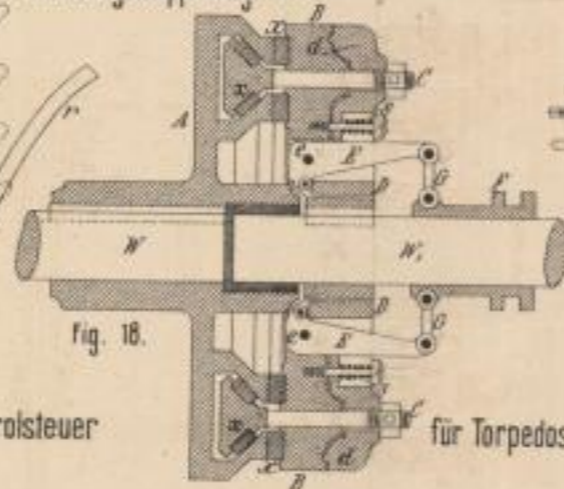

Fig. 18.

E. Mofsberg's

Schärfapparat. (15)

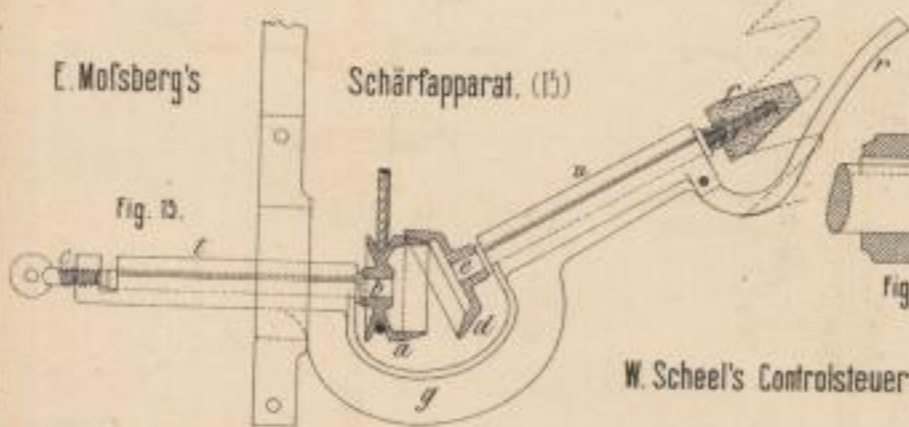

Fig. 15.

W. Scheel's Controlsteuer

für Torpedos. (16u.17)

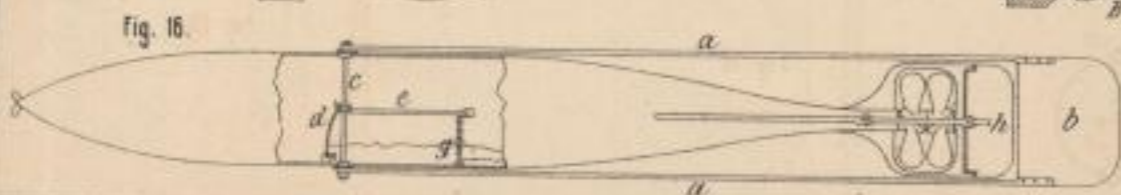

Fig. 16.



Fig. 17.

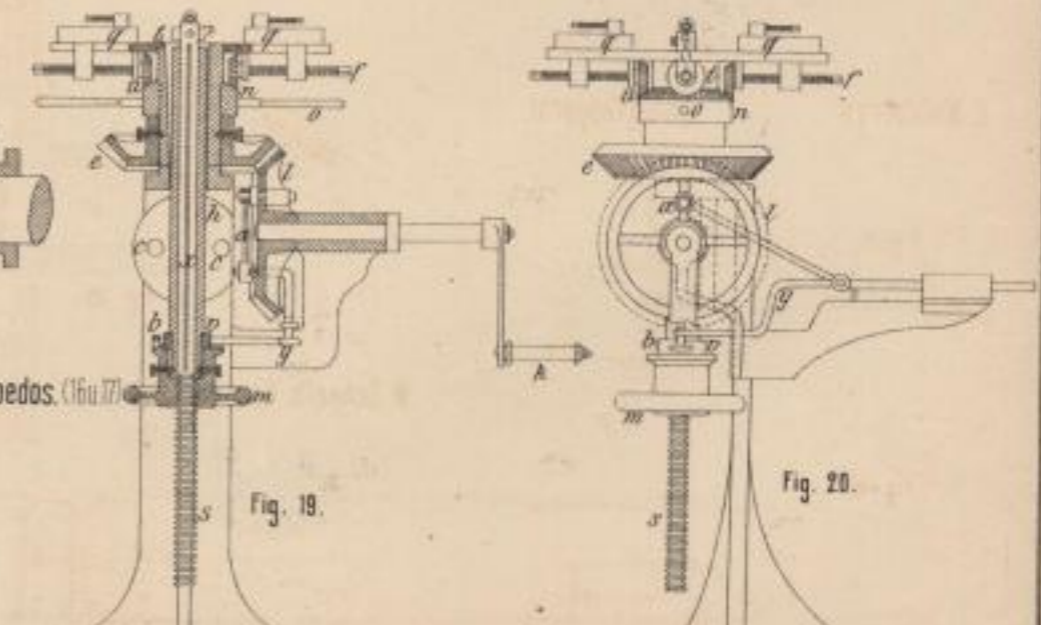

Fig. 19.

Fig. 20.

Zsh. Anst. v. J. W. v. Bismarck

Schwendy's Garn-Druckmaschine. (1 u. 2)

A. Bleichert's Schlackentransport mittels Seilbahn. (3-7)

Pneumatische Kanalisationsanlage. (8)

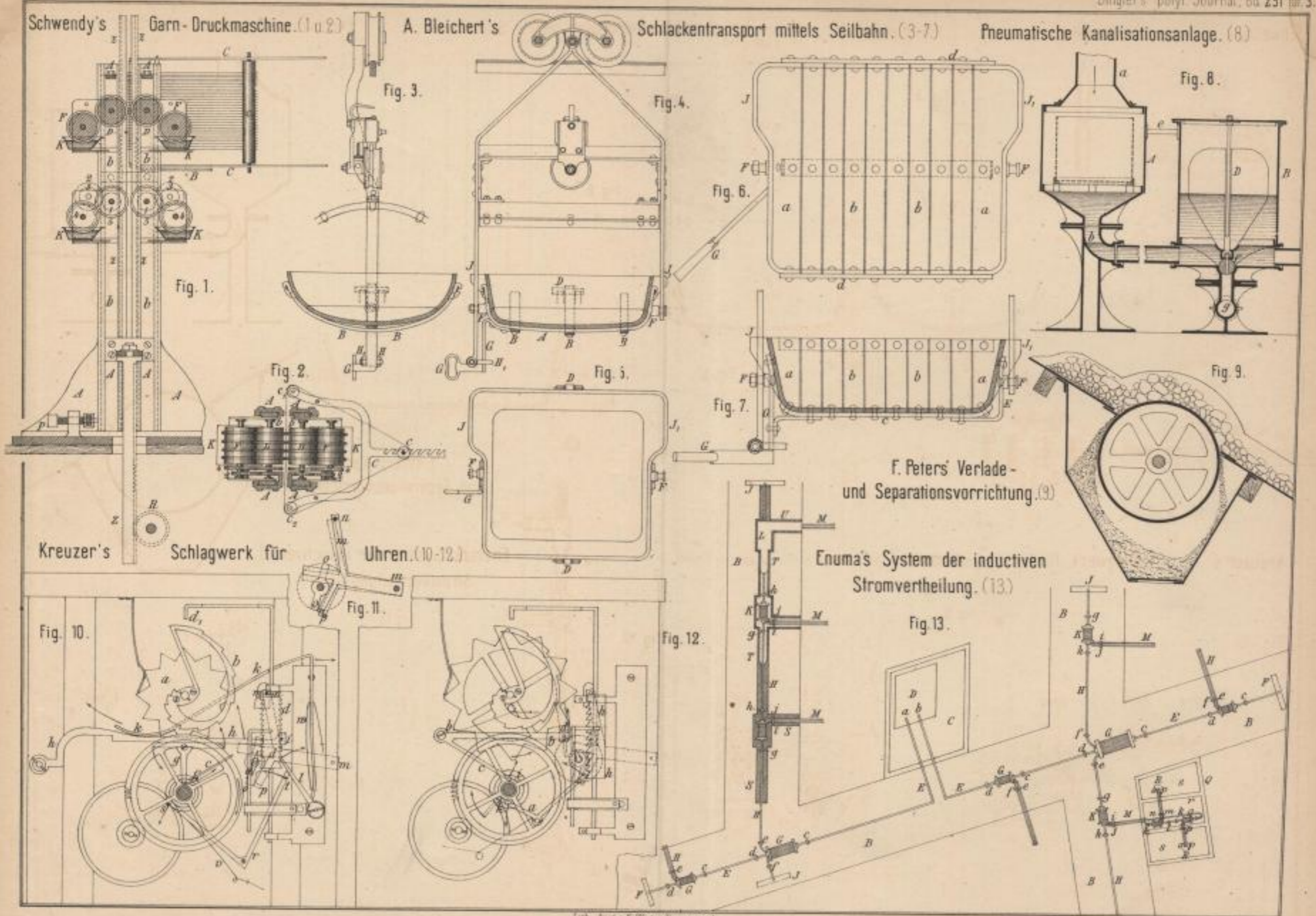

Kreuzer's Schlagwerk für Uhren. (10-12.)

F. Peters' Verlade- und Separationsvorrichtung. (9)

Enuma's System der inductiven Stromvertheilung. (13.)

Lab. Anst. v. F. Wirtz, Darmstadt.



Fig. 1.

Barker's Apparat zur Ausscheidung von Gold und Silber. (1-3)

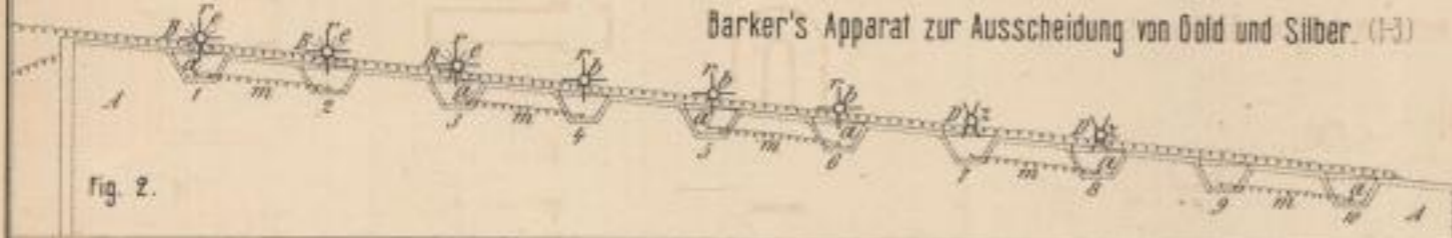

Fig. 2.

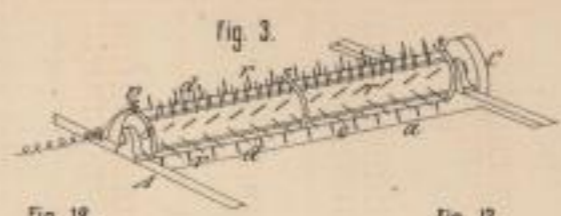

Fig. 3.

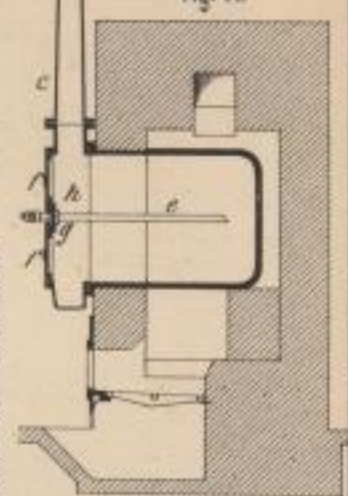

Fig. 14.

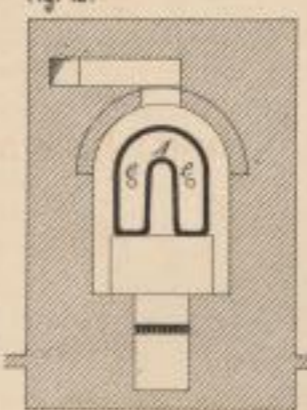

Fig. 12.

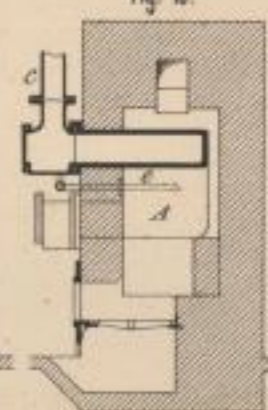

Fig. 13.

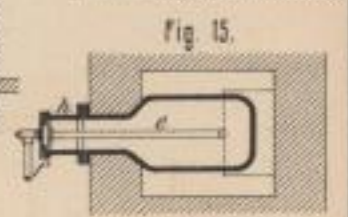

Fig. 15.

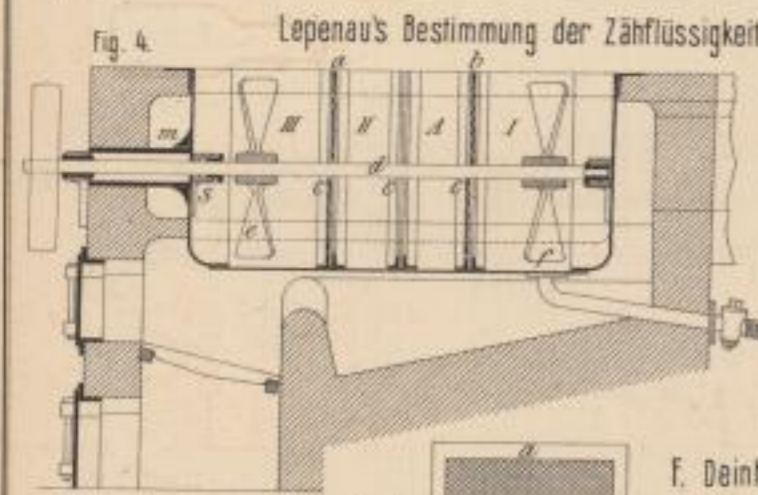

Fig. 4.

Lepenaу's Bestimmung der Zähflüssigkeit von Oelen. (9-11)

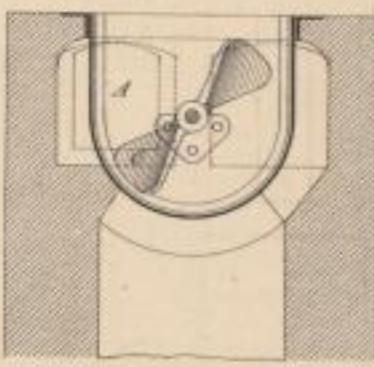

Fig. 5.

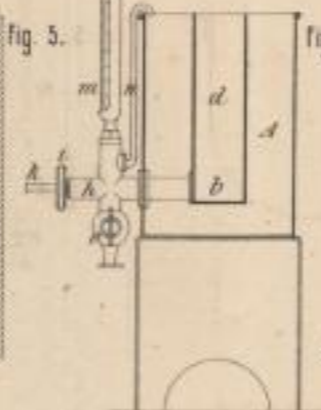

Fig. 9.

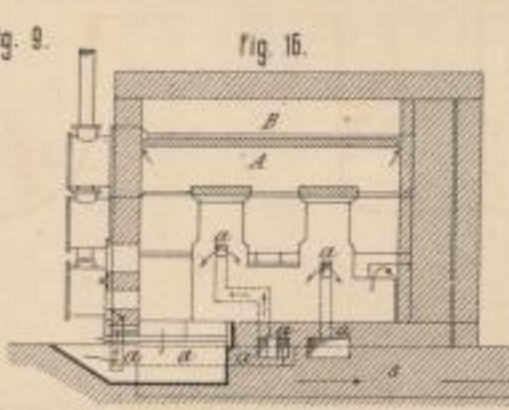

Fig. 16.

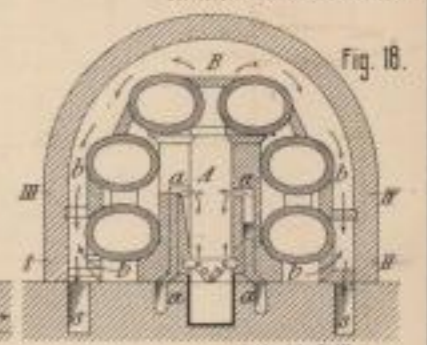

Fig. 18.

F. Deinhardt's Hopfensudapparat. (4-6)

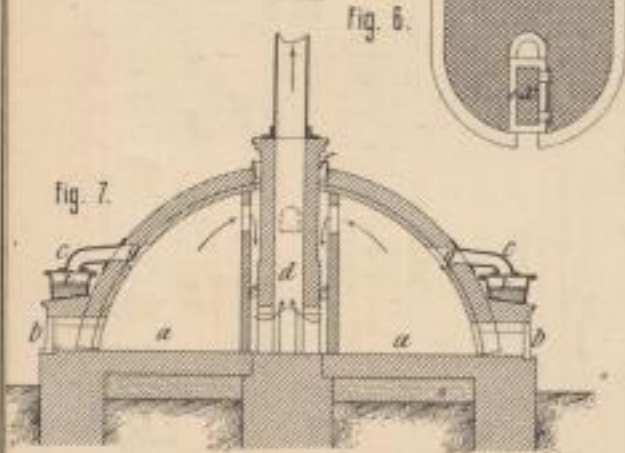

Fig. 6.

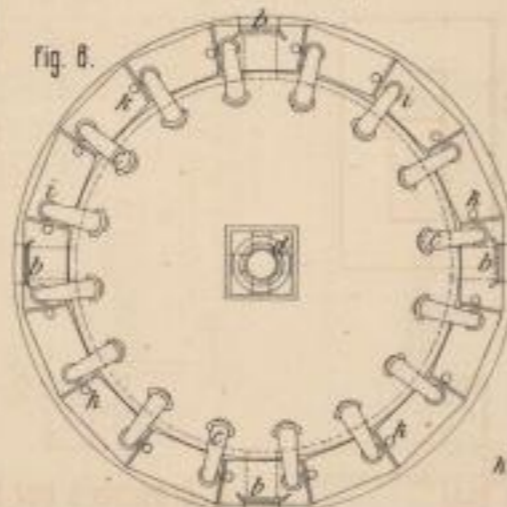

Fig. 8.

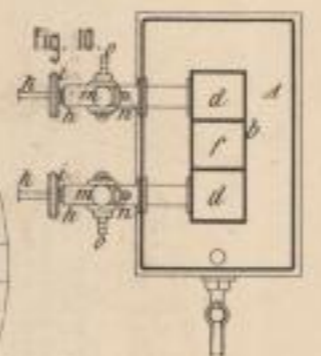

Fig. 10.

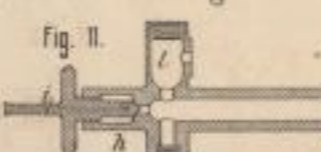

Fig. 11.

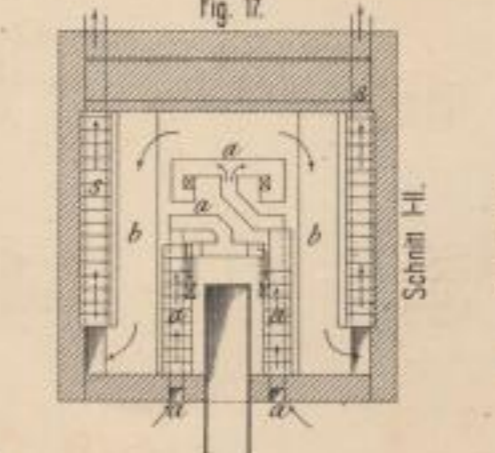

Fig. 17.

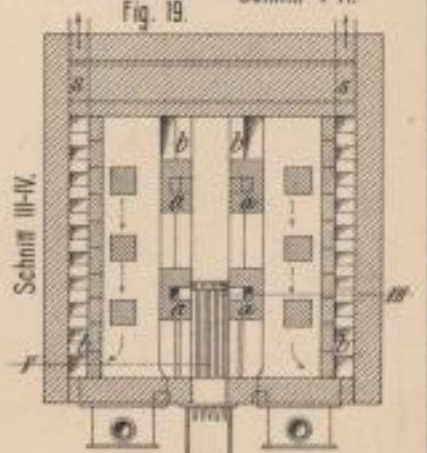

Fig. 19.

Hiltawski und Kahnert's Theergewinnung. (7u8)

R. Drescher's bez. E. Schwarzer's Herstellung von Leuchtgas. (12-19)

Lith. Anst. v. P. Wörke, Darmstadt.

### Neuerungen an Schiebersteuerungen. (Tafel 5ff)

Th. Waag. (1 u. 2)

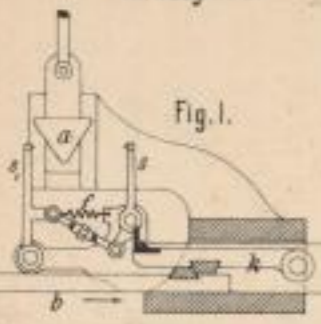

Fig. 1.

Fig. 2.

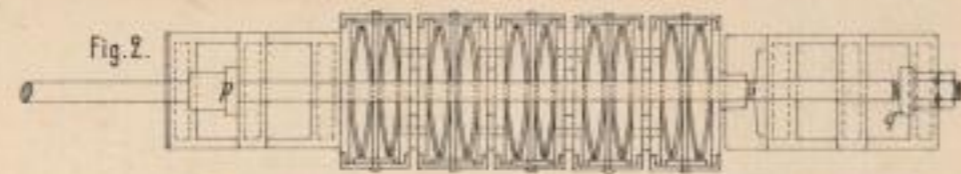

Fig. 12.

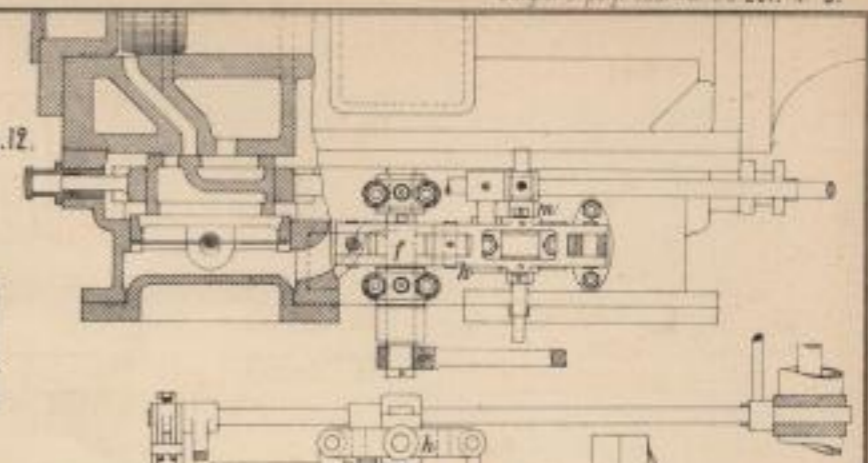

Fig. 3.

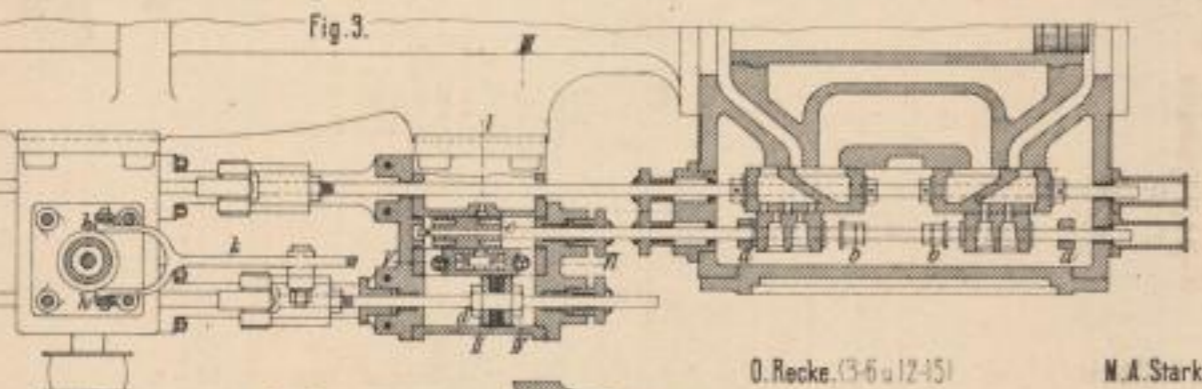
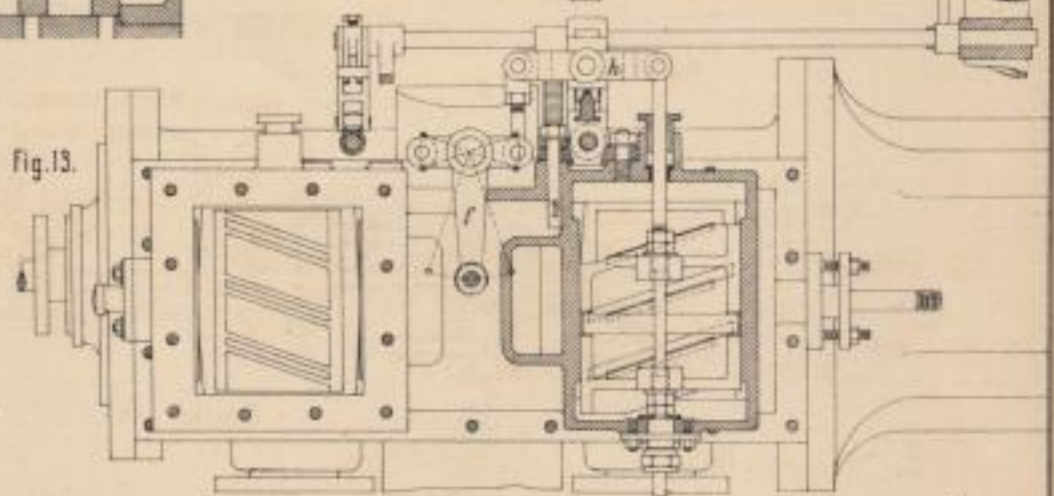

Fig. 13.



O. Recke. (3-6 u. 12-15)

M. A. Starke. (7-11)

Fig. 7.

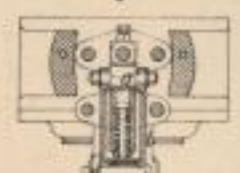

Schnitt III.

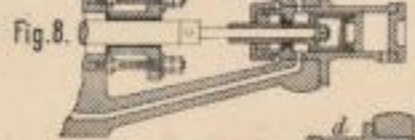

Fig. 8.

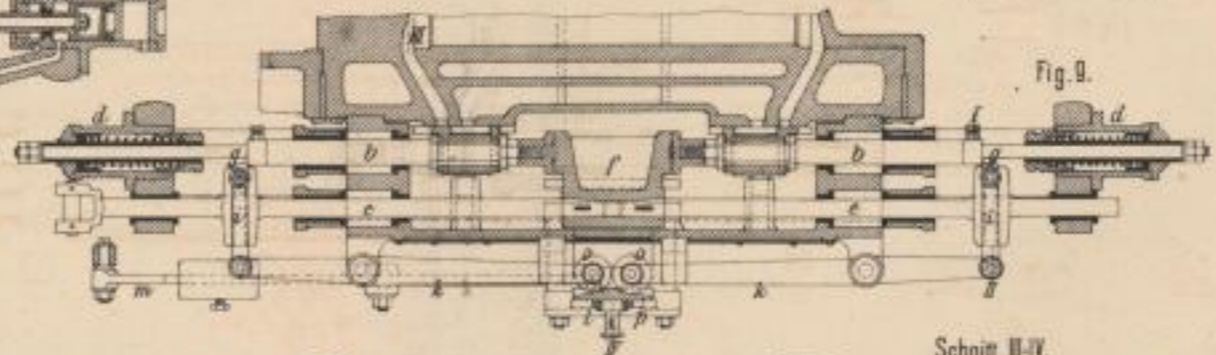

Fig. 9.

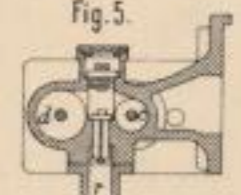

Fig. 14.

Fig. 4.

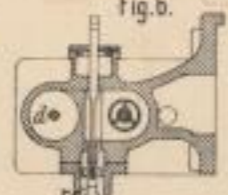

Fig. 5.



Schnitt III-IV.

Fig. 6.



Schnitt IV.

Schnitt V-VI.

Schnitt II-IV.

Fig. 11.

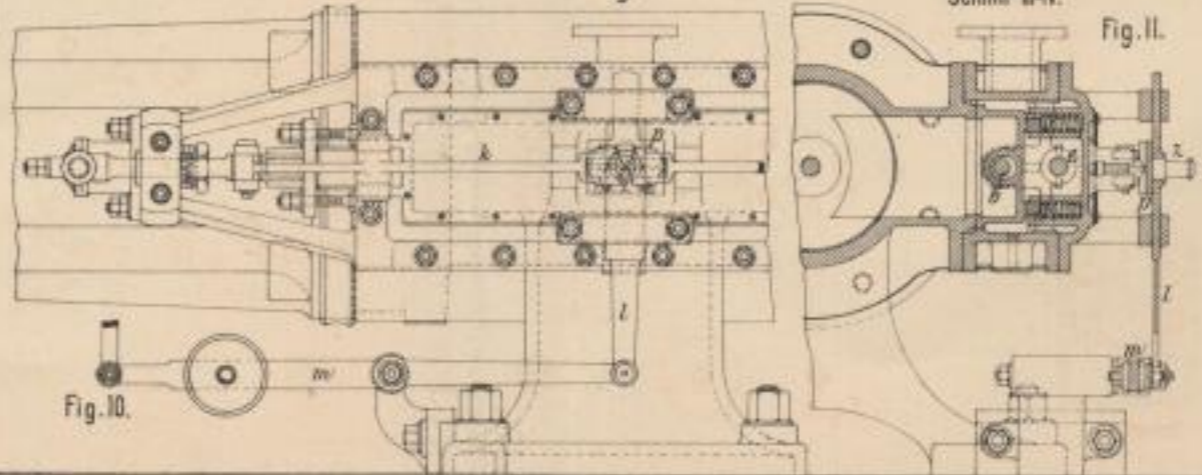

Fig. 15.

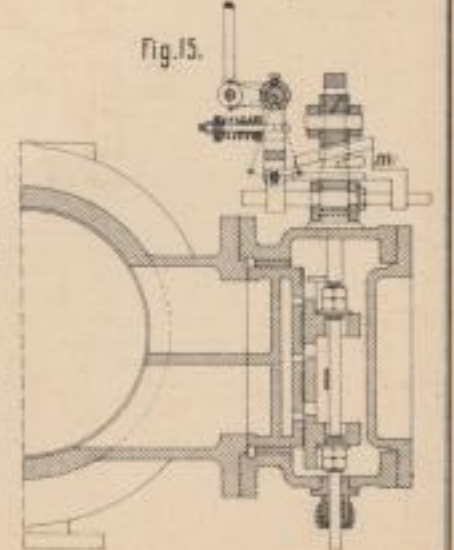
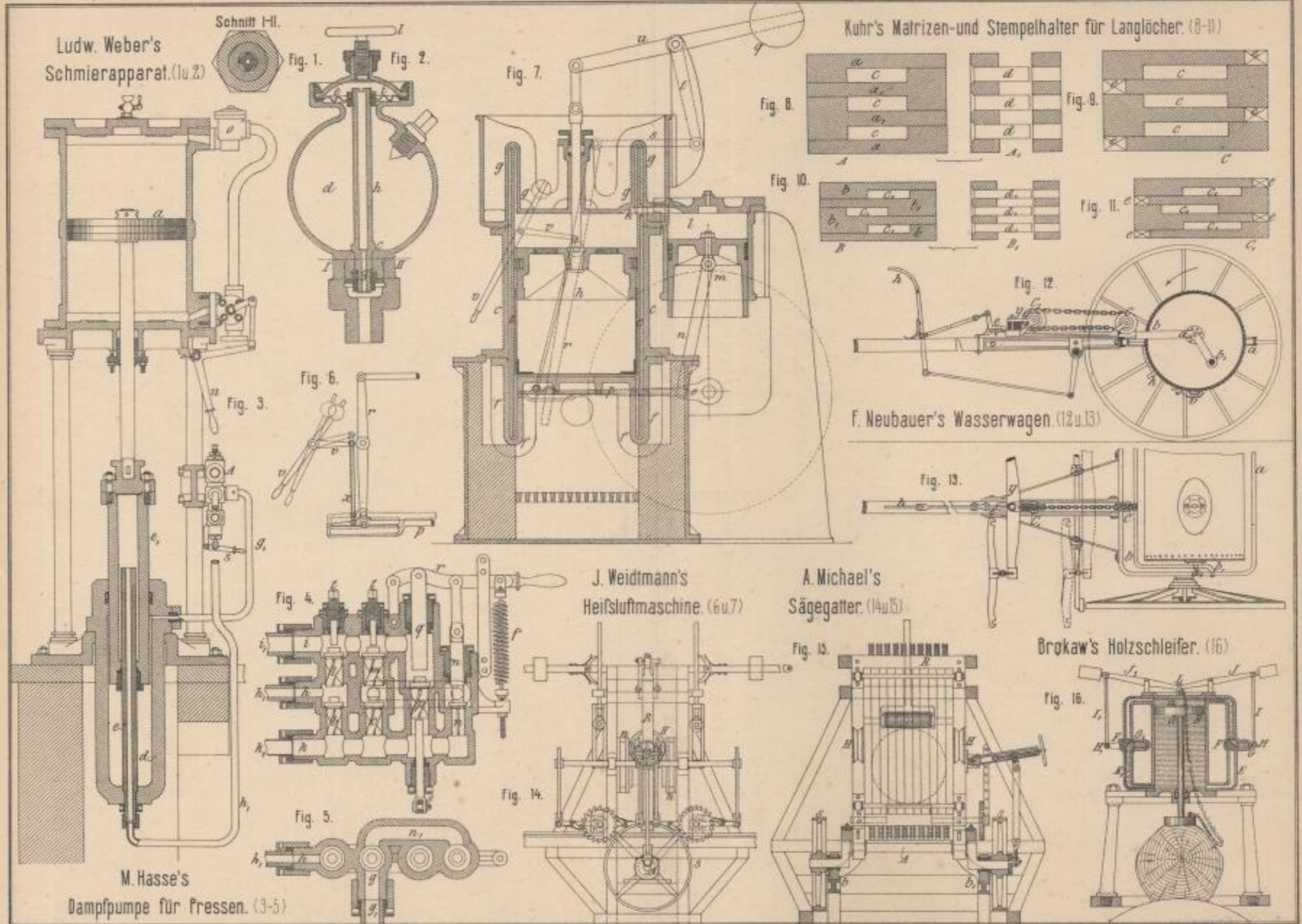
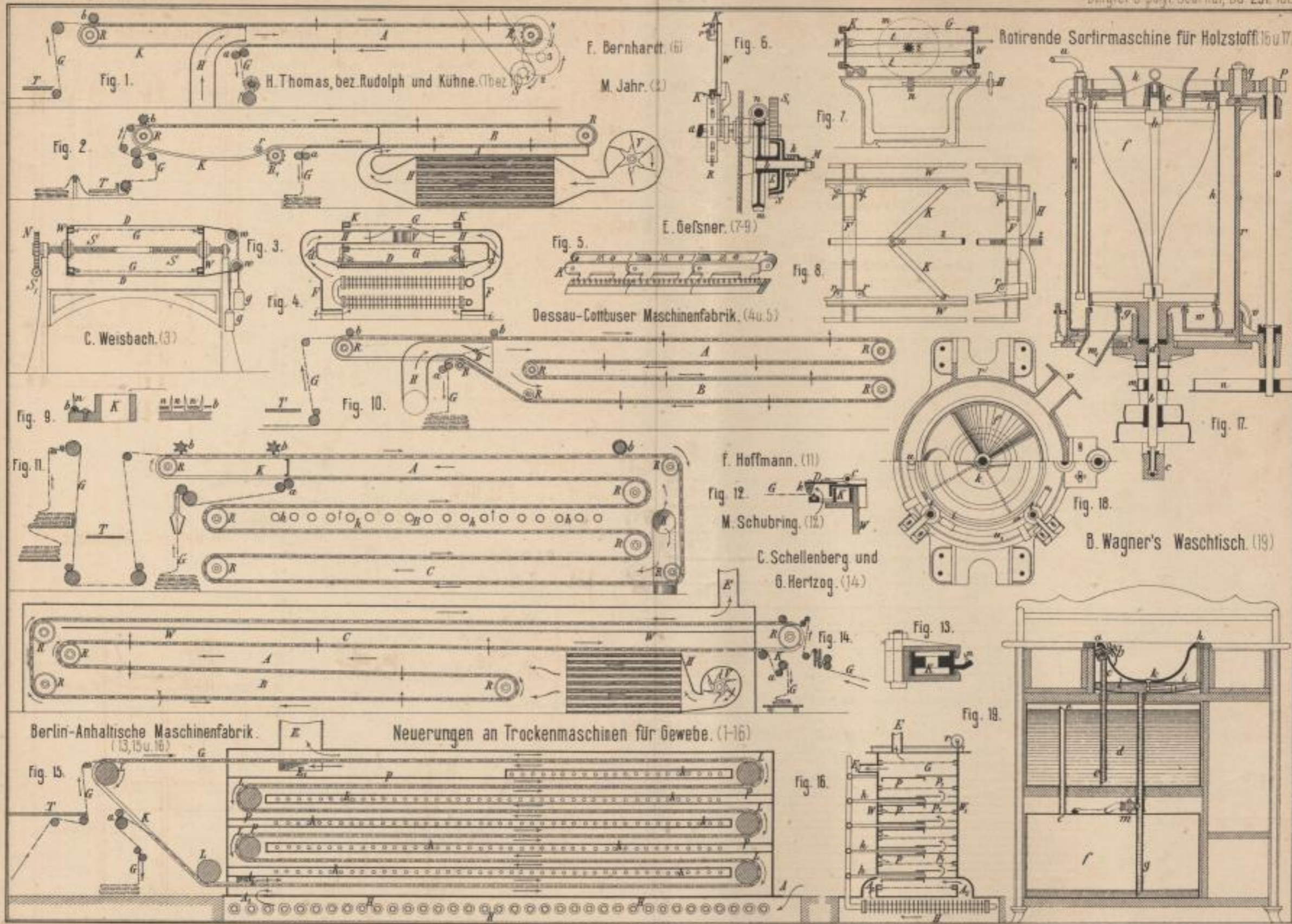

Fig. 10.

Lith. Anst. v. W. Pfeil, Leipzig



Lith. Anst. v. F. Wörts, Darmstadt.



Ver. Anstalt v. F. W. W. Darmstadt.



Kendall's Benzolgewinnung aus Kohlen-Gas. (10 u 2)

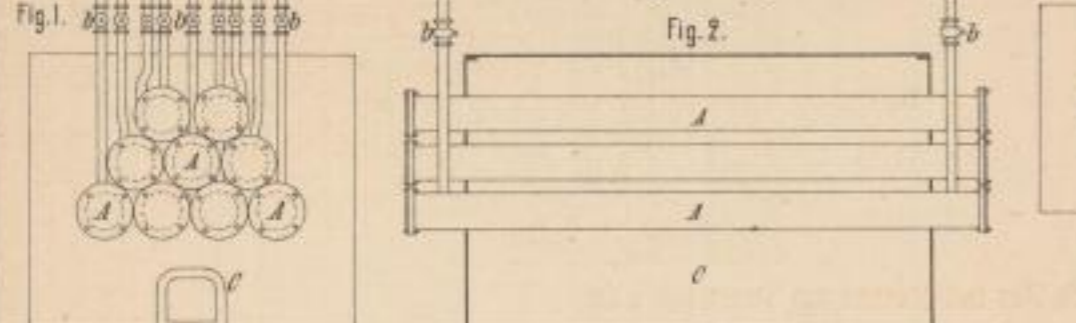

F. Meiser's Ofen zum Brennen von Strontianit u. dgl. (7-9)

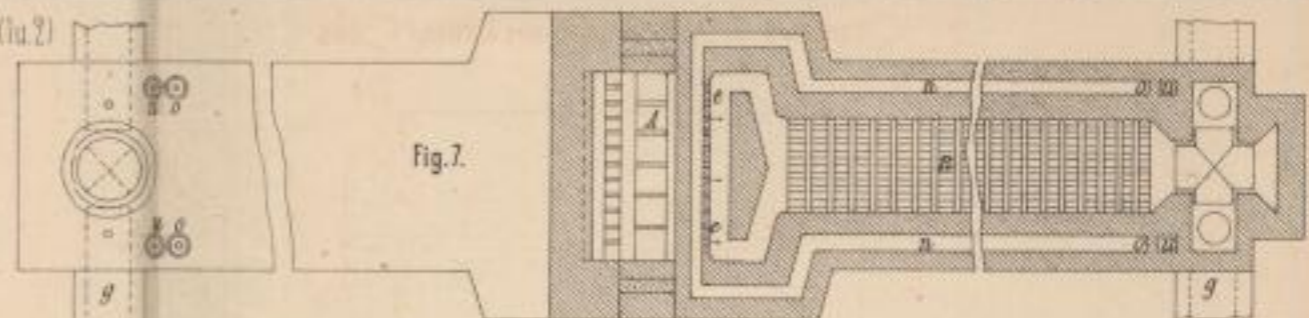

E. Hänel und Gebauer's Trocken-Apparat für Knochenkohle. (13)

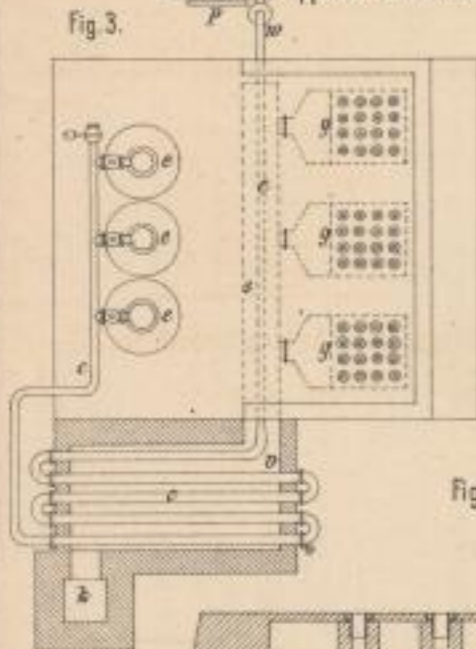

H. Gruson's Herstellung von Maische u. dgl. (14)

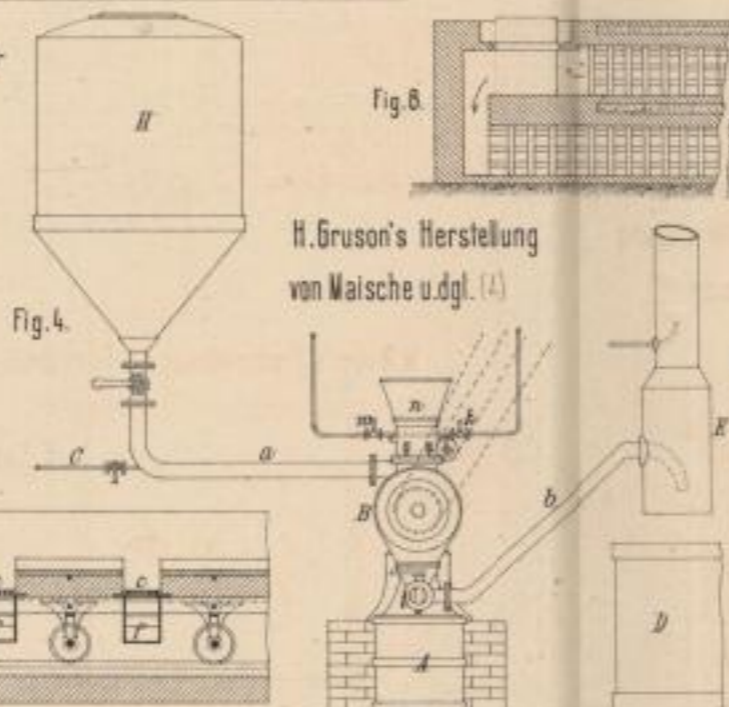

M. Müller's Probenehmer für Filterabsüßwässer. (10 u 11)

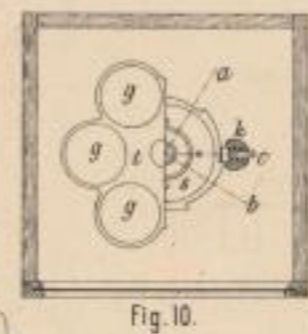

E. Sostmann's Füllapparat für Kalklöschmaschinen. (12)

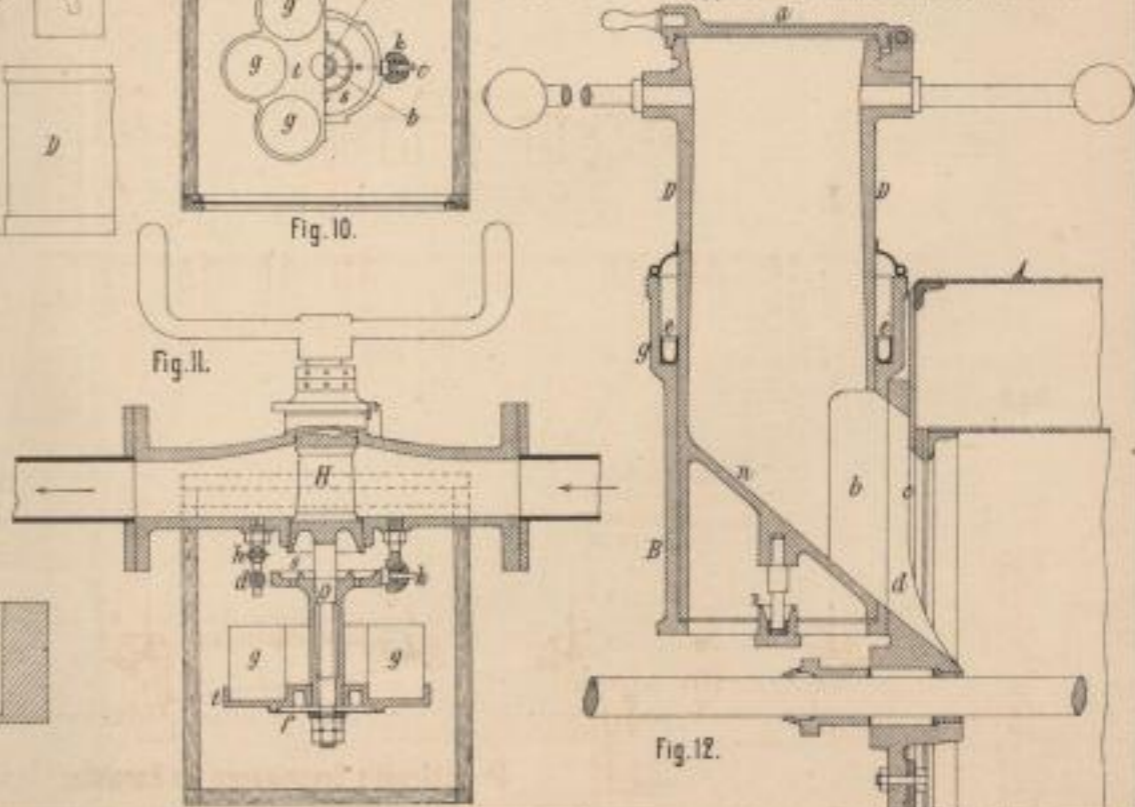

Th. Schlegel's Brennwagen für Kanalöfen. (15 u 16)

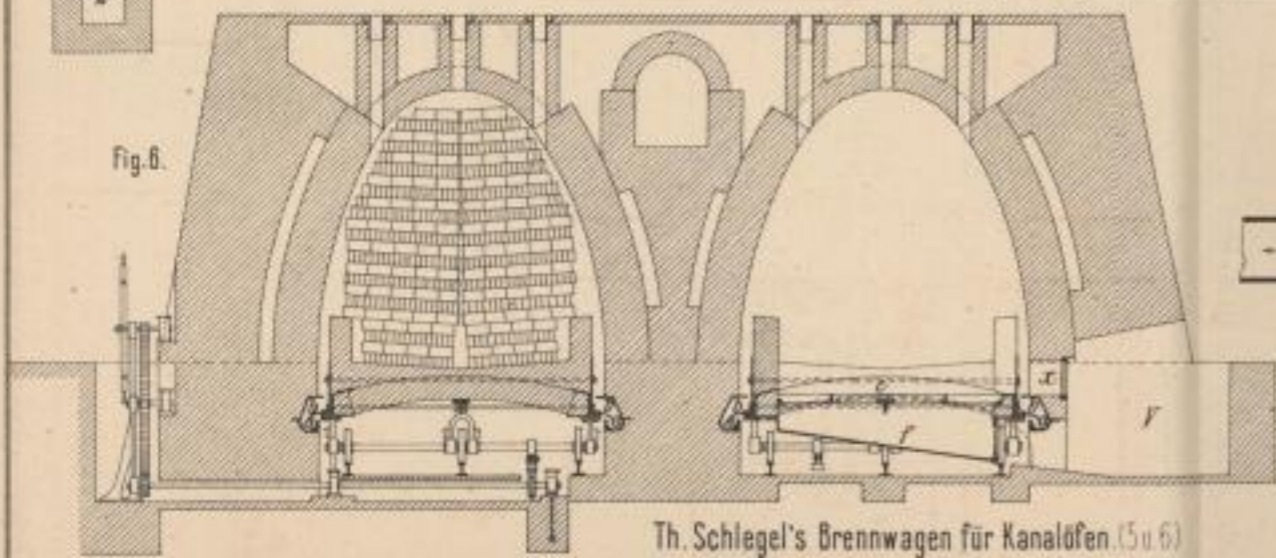

Lith. Inst. v. F. Wirtz, Darmstadt.



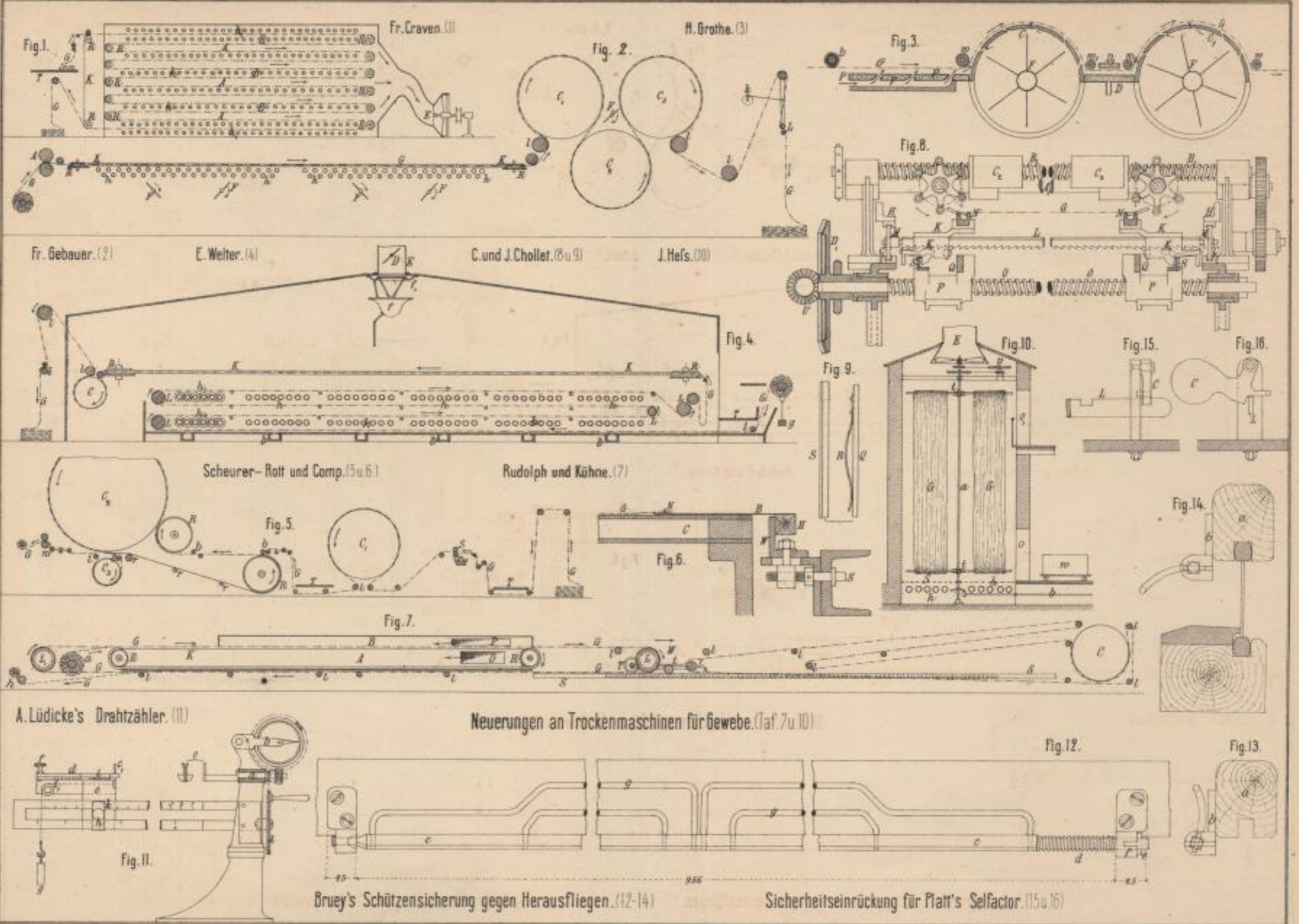

Lith. Anst. v. F. W. W. Darmstadt.

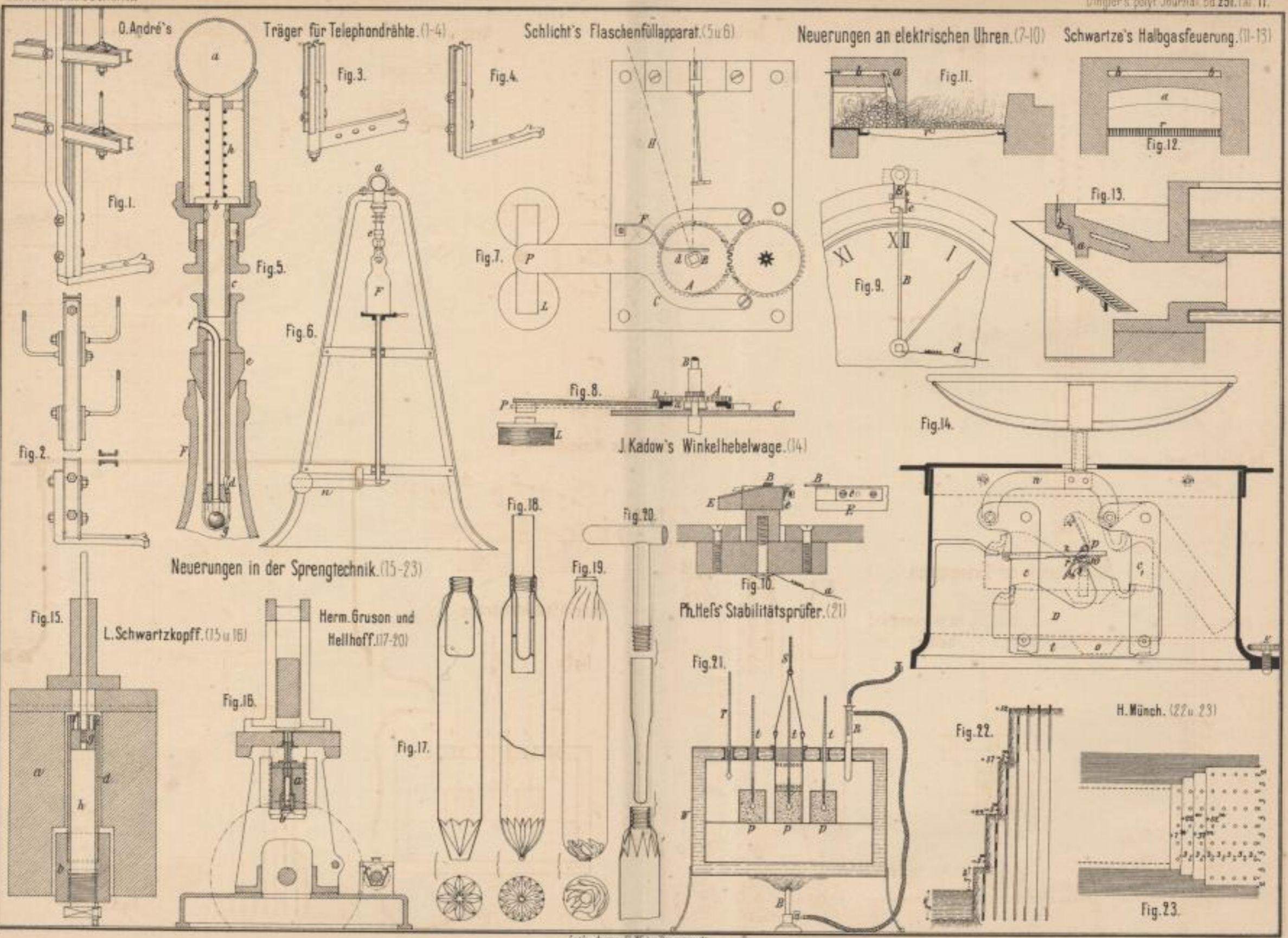

Lith. Anst. v. F. W. Bartsch, Darmstadt.

O. Türcke. (1-5)

Neuerungen an Schiebersteuerungen. (Taf. 159, Zu 13)

H. Schliggemann. (6-9)

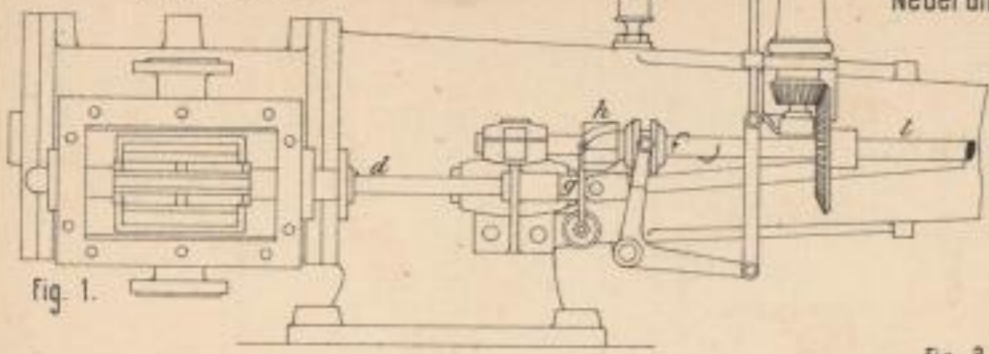

Fig. 1.

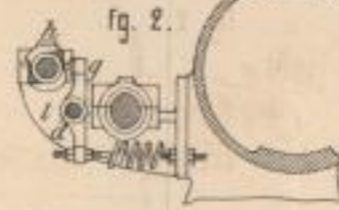

Fig. 2.

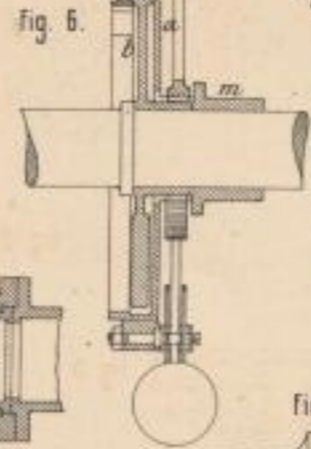

Fig. 6.

Fig. 7.

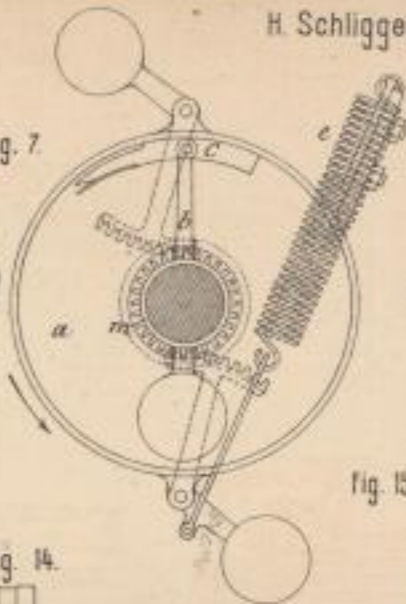

Fig. 8.

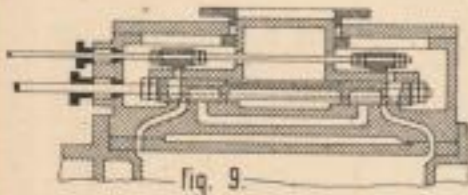
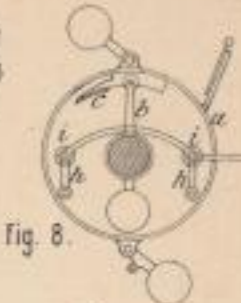

Fig. 9.

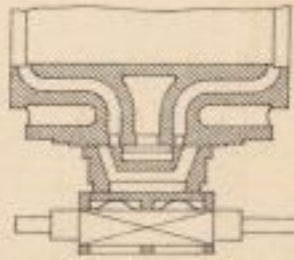

Fig. 5.

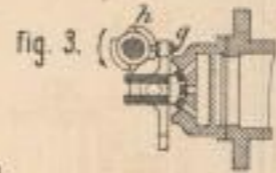

Fig. 3.

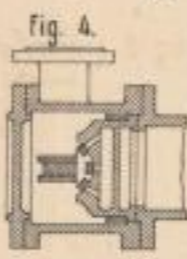

Fig. 4.

A. Kohlstadt. (10 u 11)

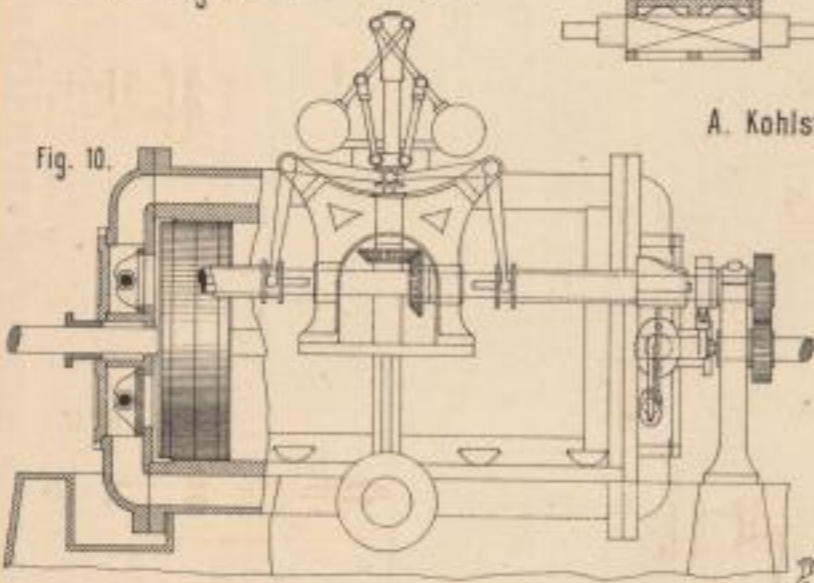

Fig. 10.

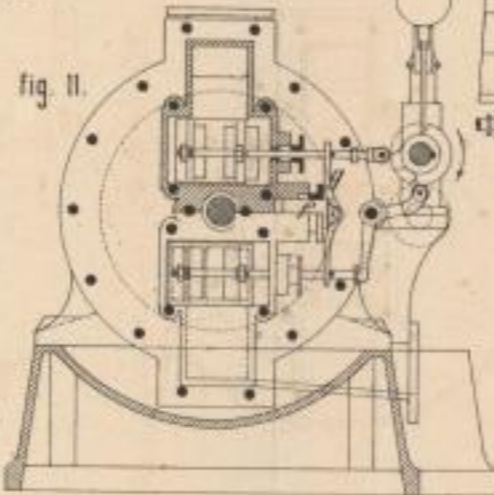

Fig. 11.

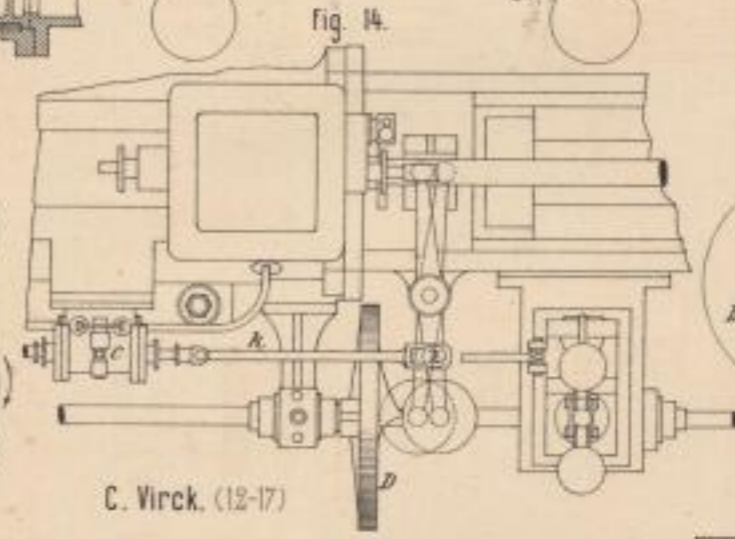

Fig. 14.

C. Virck. (12-17)

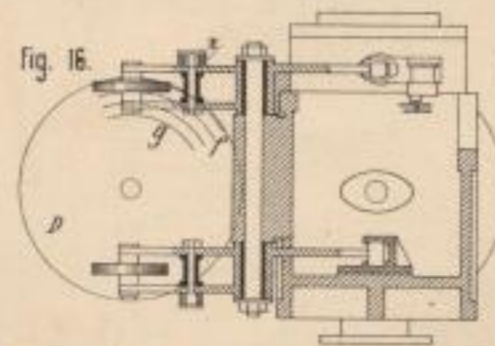

Fig. 16.

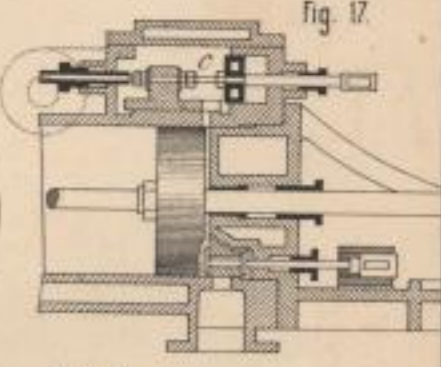

Fig. 17.

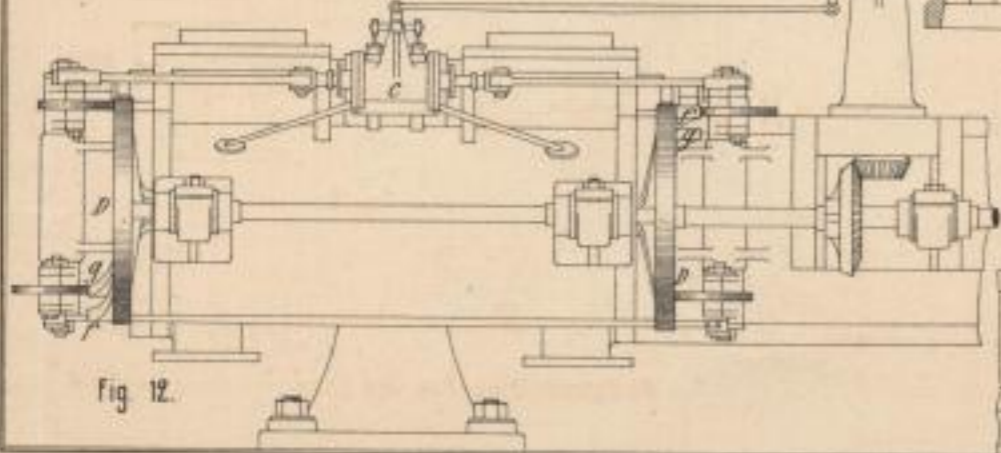

Fig. 12.

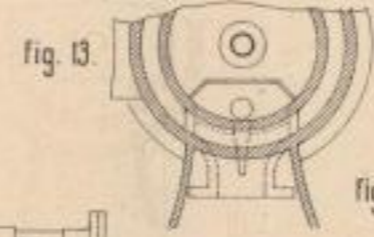

Fig. 13.

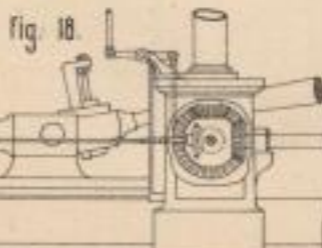

Fig. 18.



Fig. 19.

Woolstenhulmes, Rye und Comp. (18 u 19)

Lith. Anst. v. F. Rörtsch, Darmstadt.



Neuerungen an Schiebersteuerungen.

(Taf. 1, 5, 9, 12 u. 13)

Goldschmidt-Hahlo's entlasteter Kolben für rotirende Maschinen. (9-11)

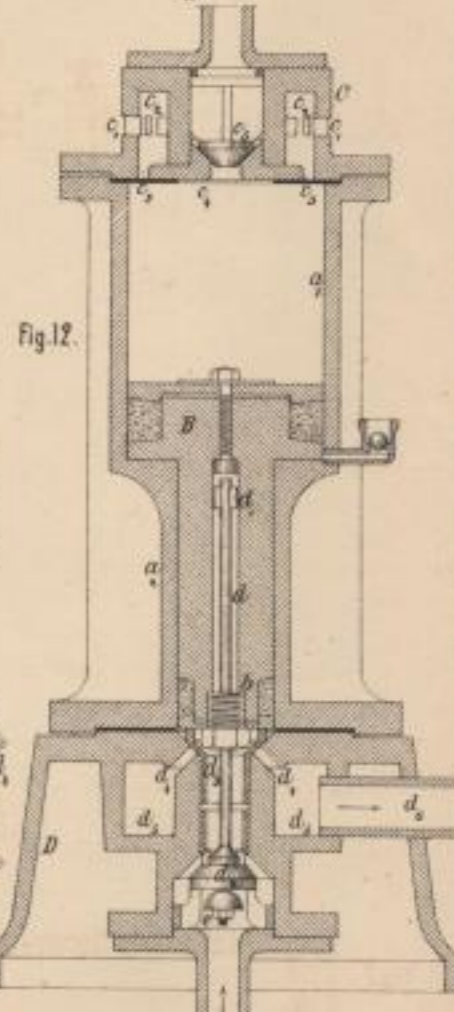
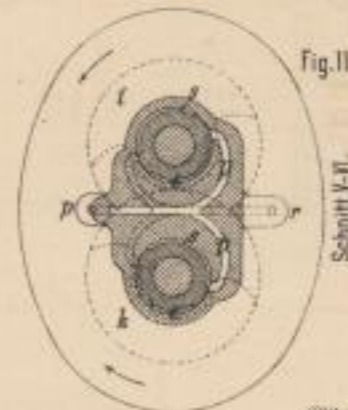
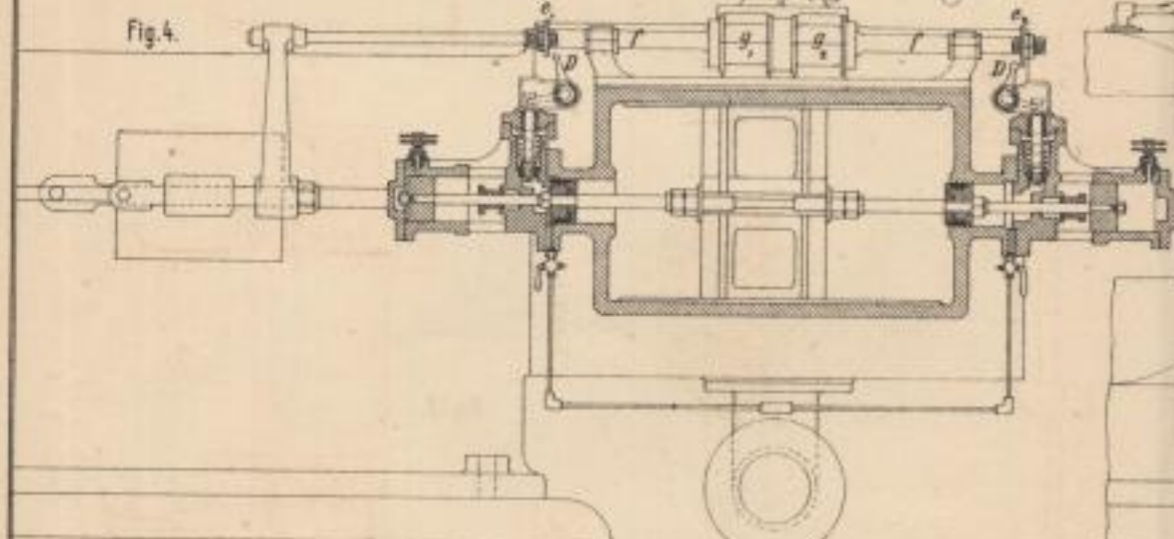
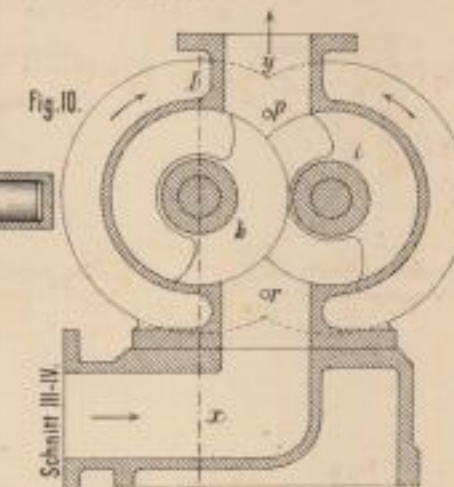
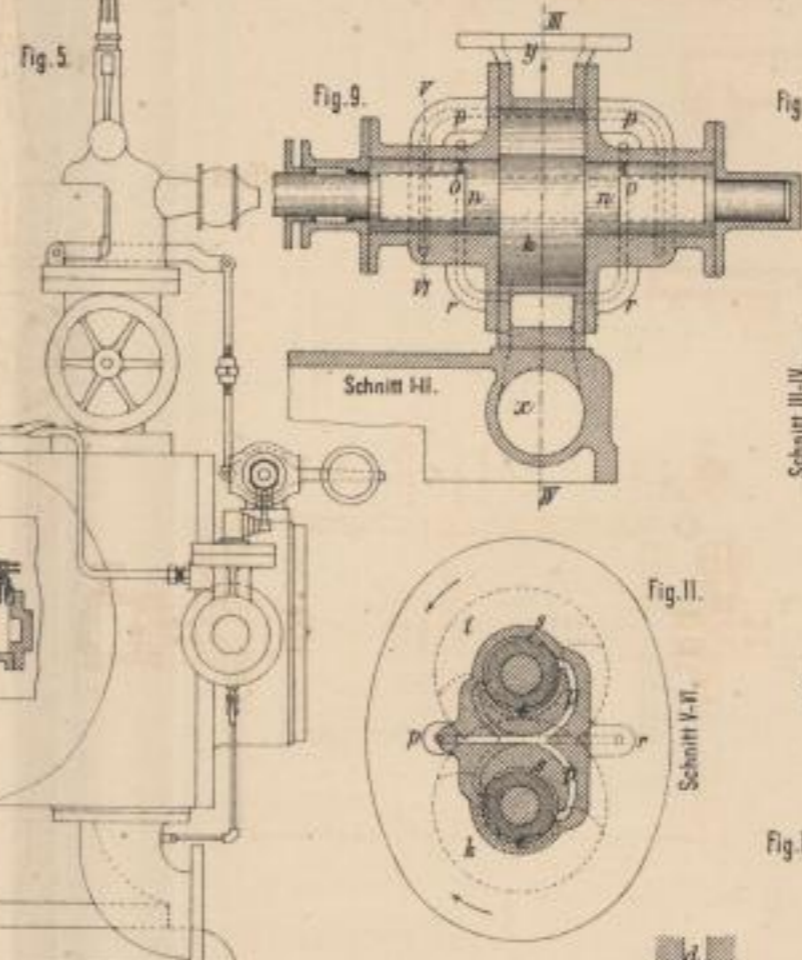
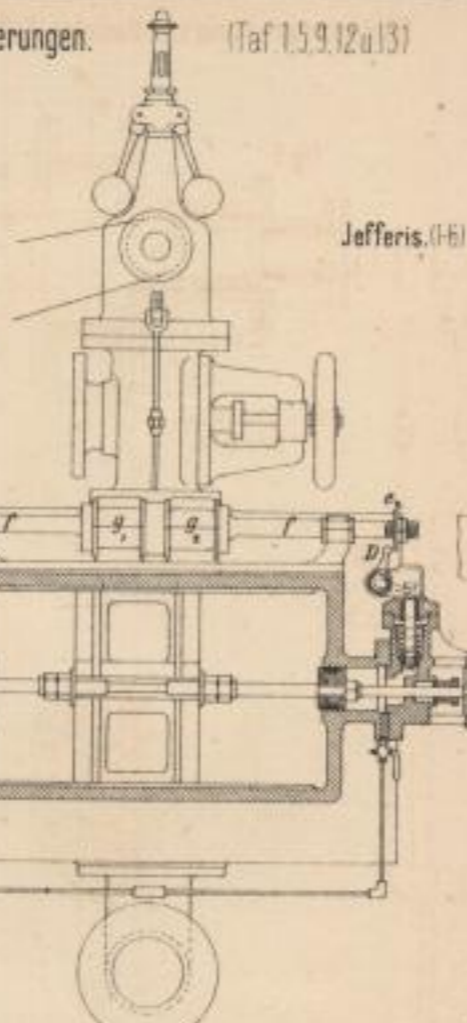
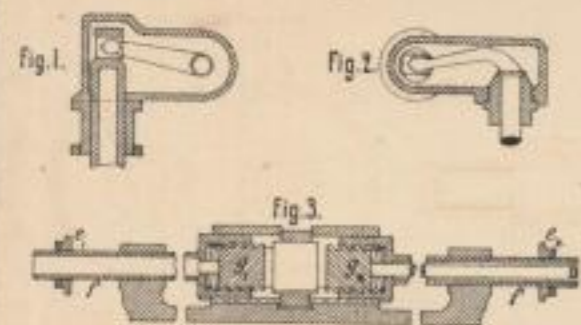

A. Bachmeyer's Ausrückvorrichtung. (14)

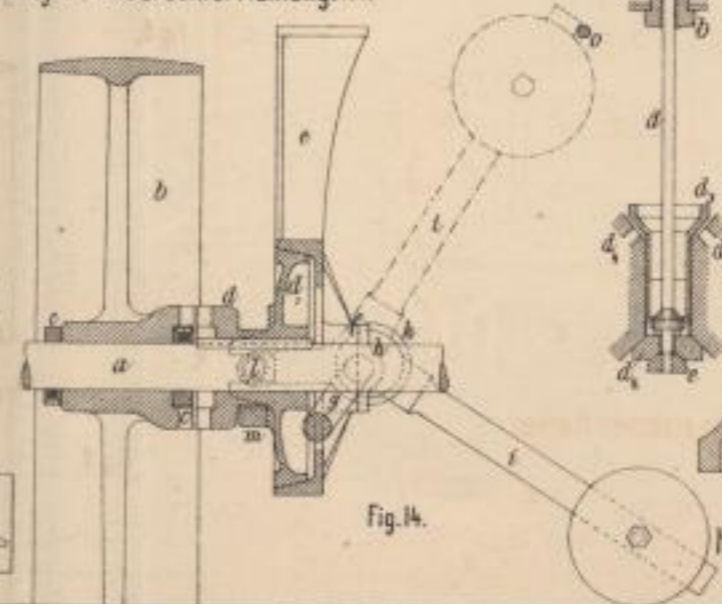
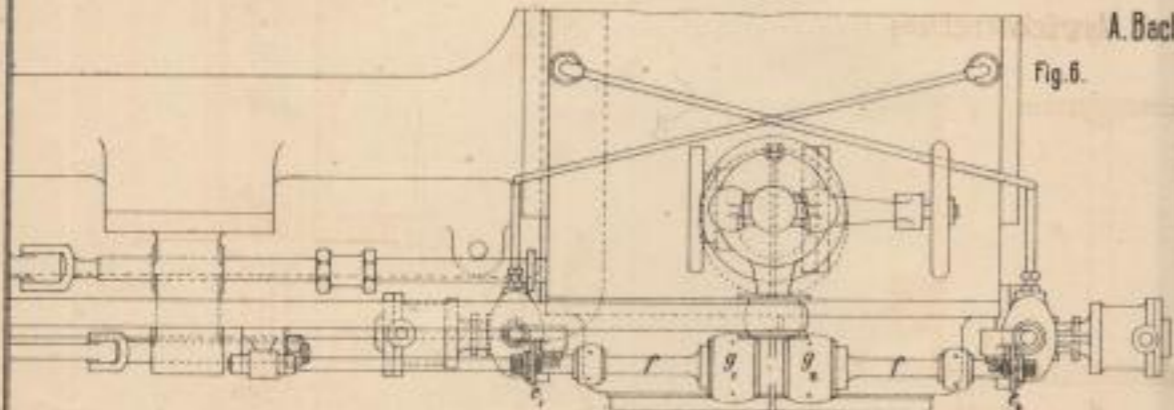

Carlsson's Herstellung eiserner Marken. (7 u. 8)

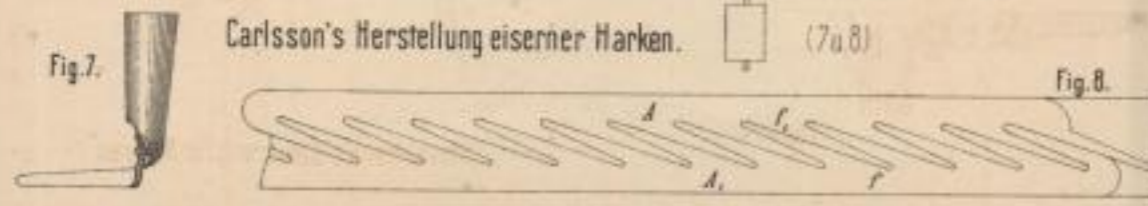

Hävelmann's Steuerung für Motoren. (12 u. 13)

Lith. Anst. v. F. Witz, Darmstadt.

Stickel's Bestech- und Einsteckapparat für Schuhwaaren. (1 u. 2.) Sackfilter der Pulsometer Comp. (3)

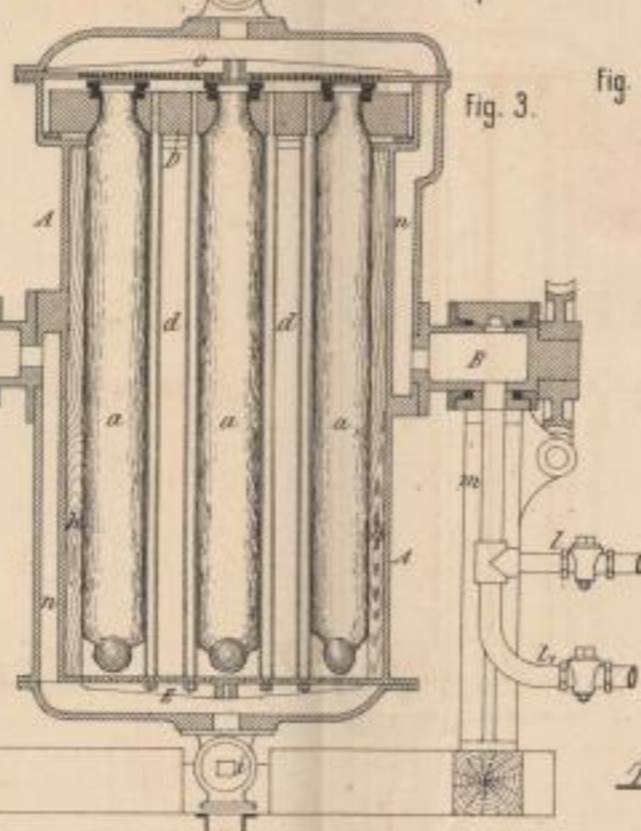
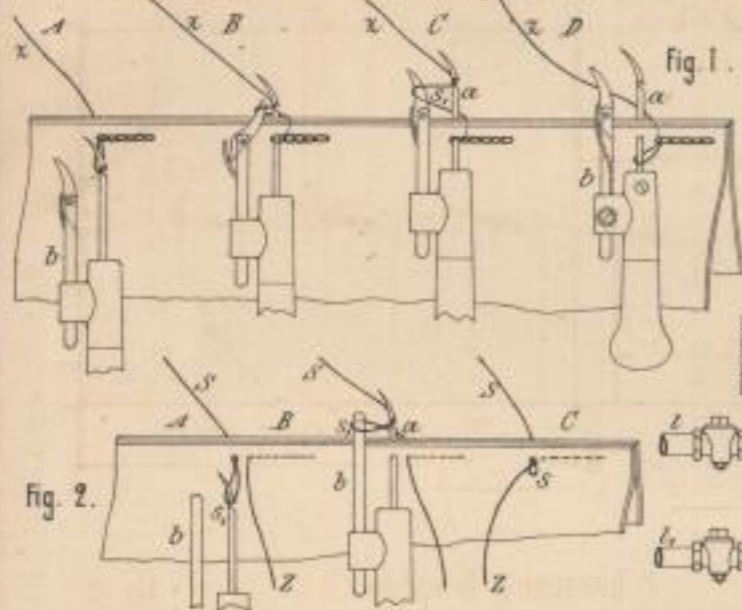

Raetke's Desinfections- und Bettfeder Reinigungsapparat. (4)

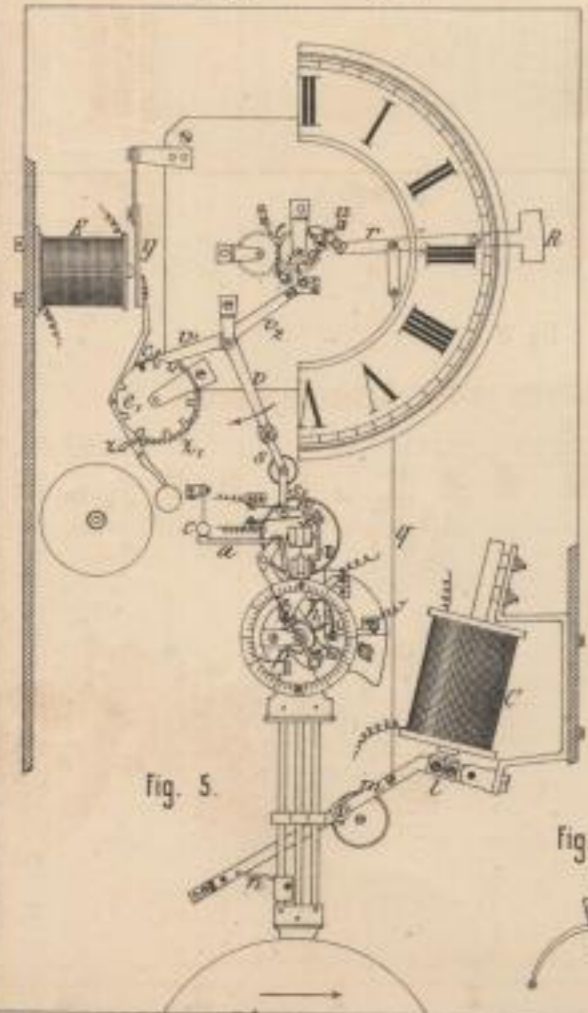
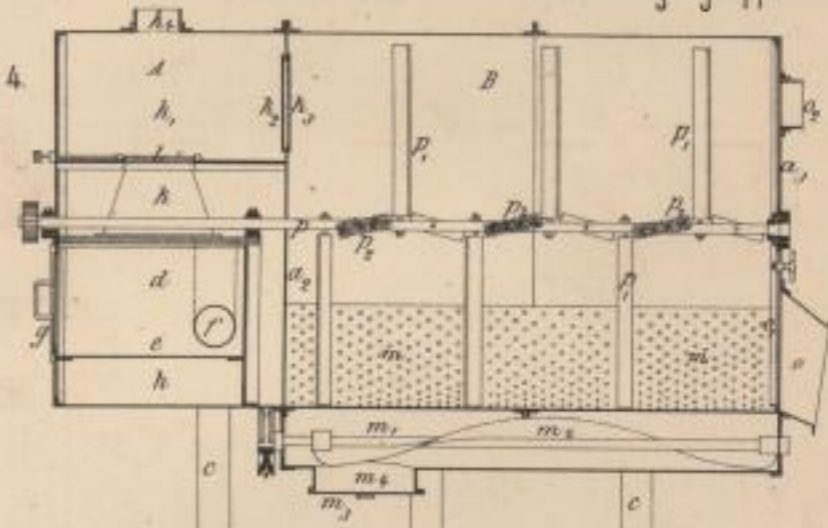

Herotizky's elektrische Uhr. (5-7)

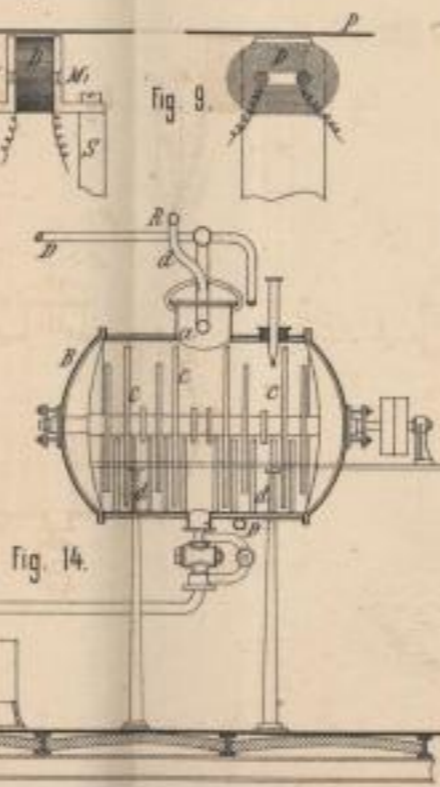
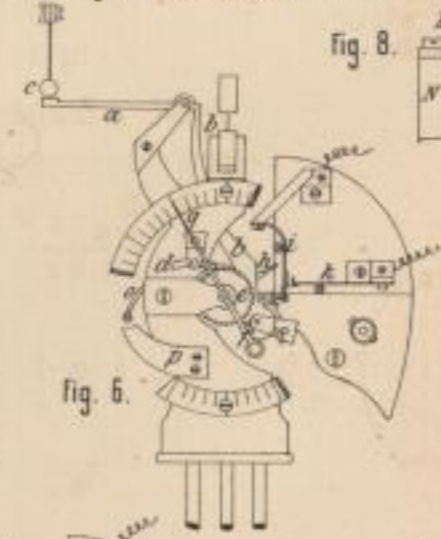

P. Tutzauer's Telephon. (8-13)

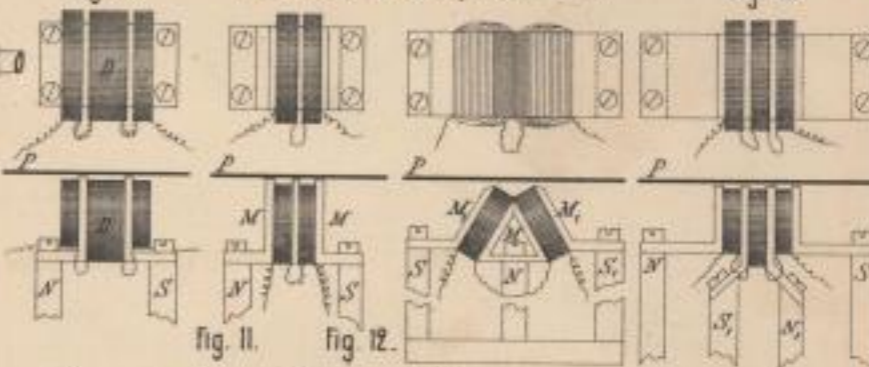

Zimmer's Brauverfahren mittels Schleudertrommel. (14 u. 15)

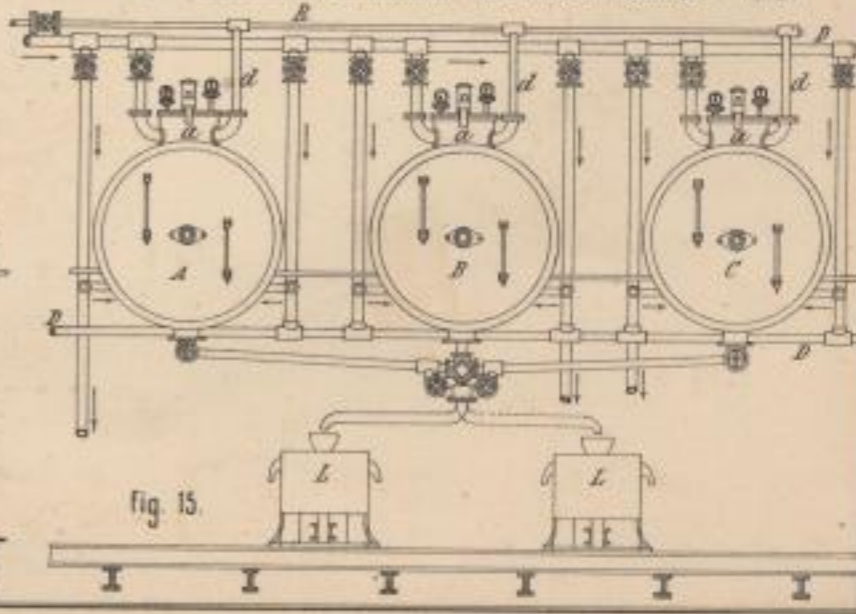

Lith. Anst. v. F. W. G. Jarmstadt

Neuerungen an Regulatoren. (1-13)

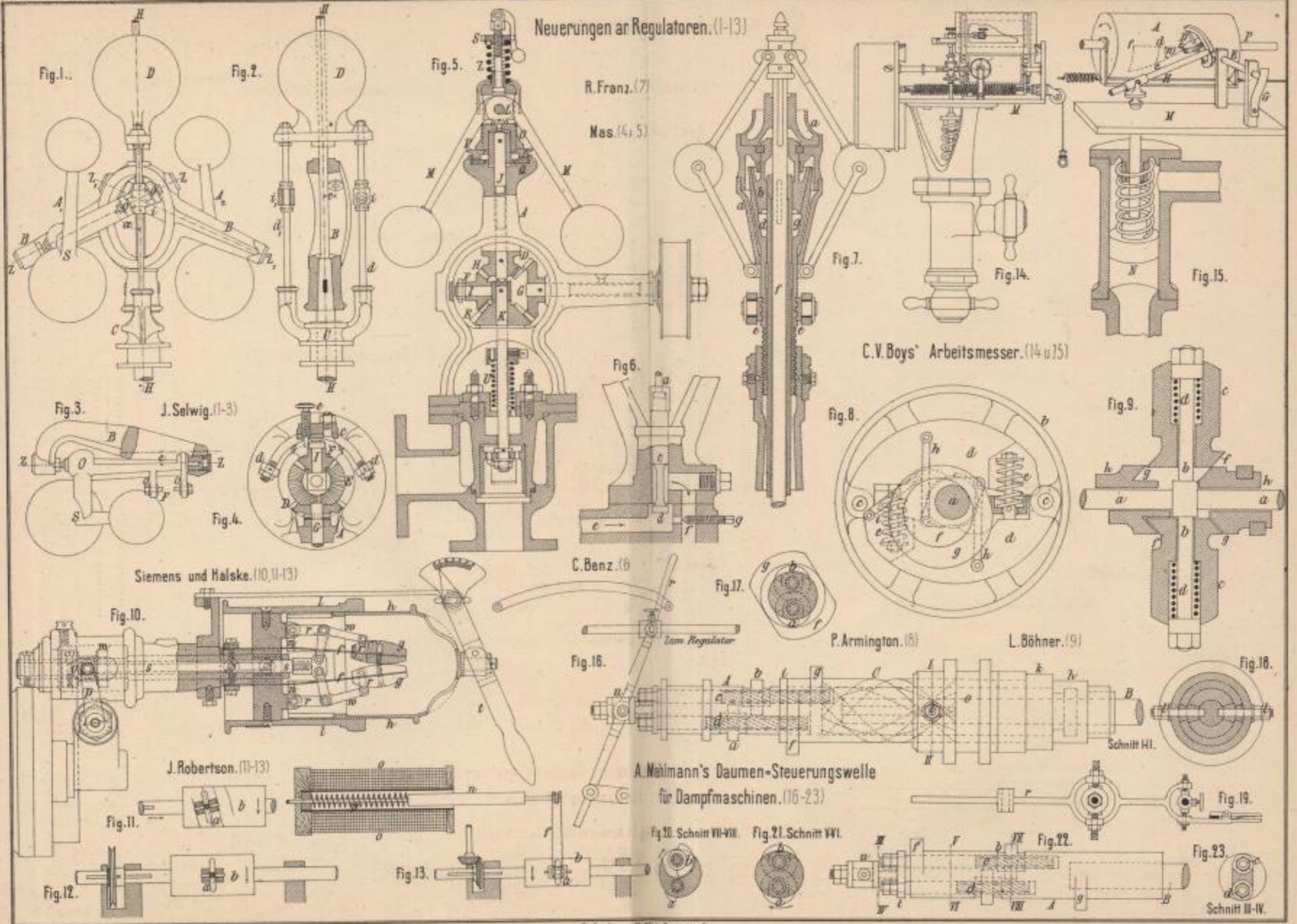

R. Franz. (7)  
Mas. (4, 5)

C. V. Boys' Arbeitsmesser. (14 u 15)

J. Selwig. (1-3)

Siemens und Halske. (10, 11-13)

C. Benz. 16

A. Nahlmann's Daumen-Steuerungswelle für Dampfmaschinen. (16-23)

J. Robertson. (11-13)

Lam Regulator

P. Armington. (6)

L. Böhner. (9)

Fig. 10. Schnitt VII-VIII.

Fig. 21. Schnitt VII.

Fig. 22.

Fig. 23.

Schnitt II-IV.

Lith. Anst. v. F. W. v. Tarnow.



Kammerich's Herstellung von Träger-Wallblech. (1-3)

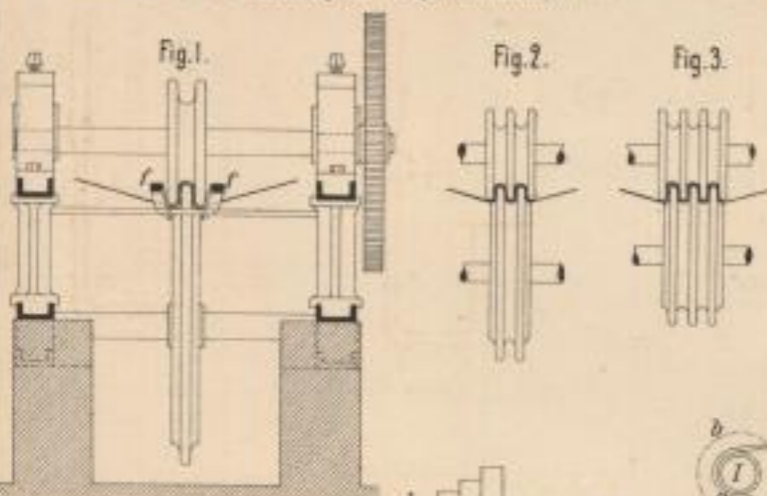

W. Beckert's Schränkeisen. (4-5)

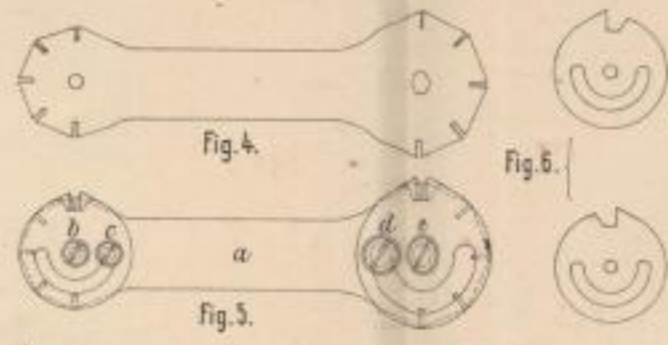

Königin Marienhütte. (14-19)

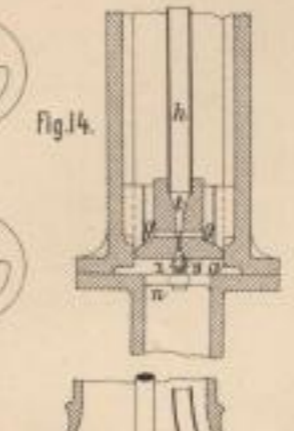

Neuerungen an Hydranten. (14-21)

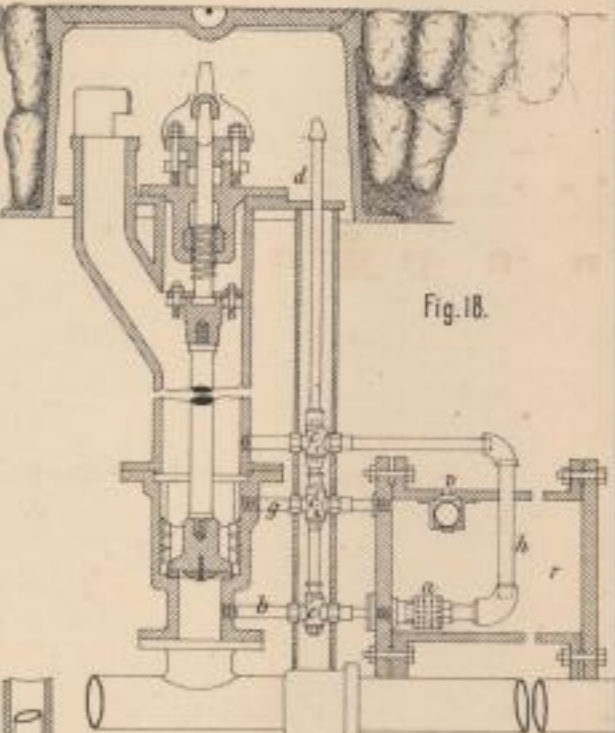
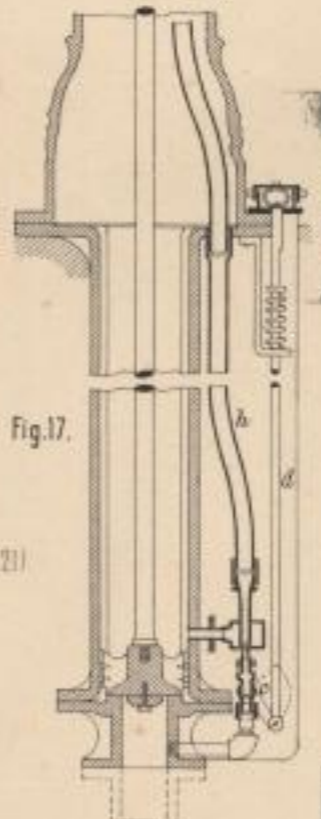
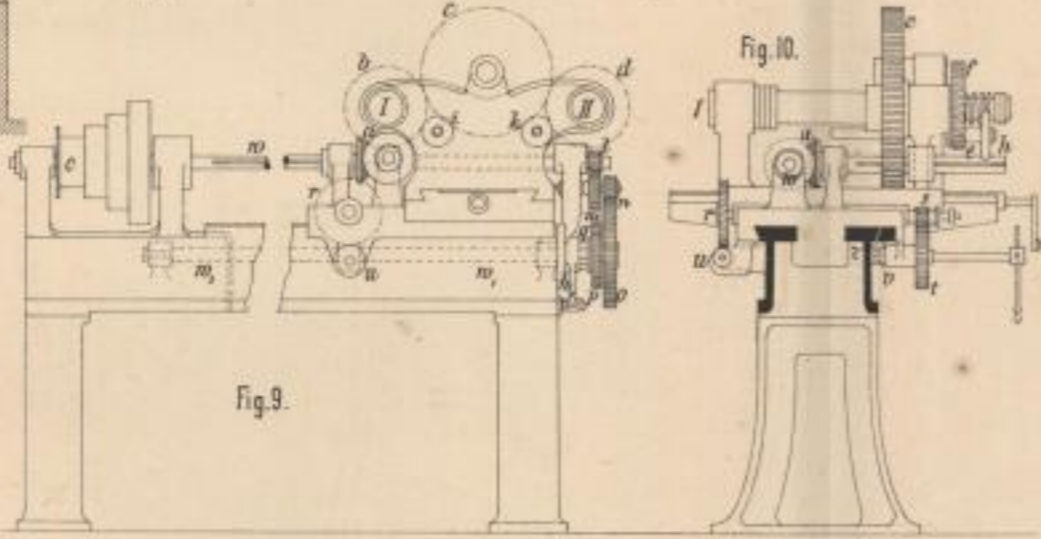
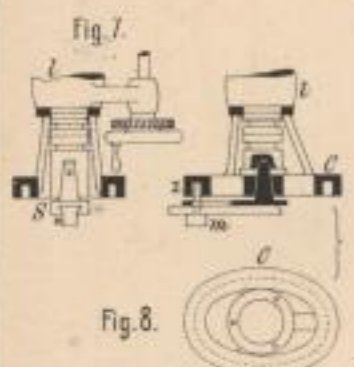
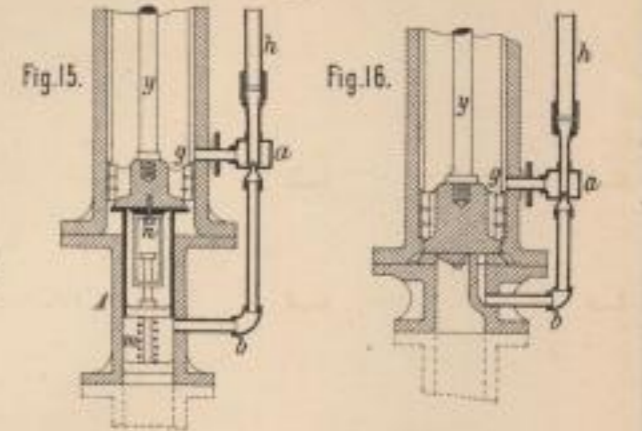

Werkzeugmaschinen zur Bearbeitung von

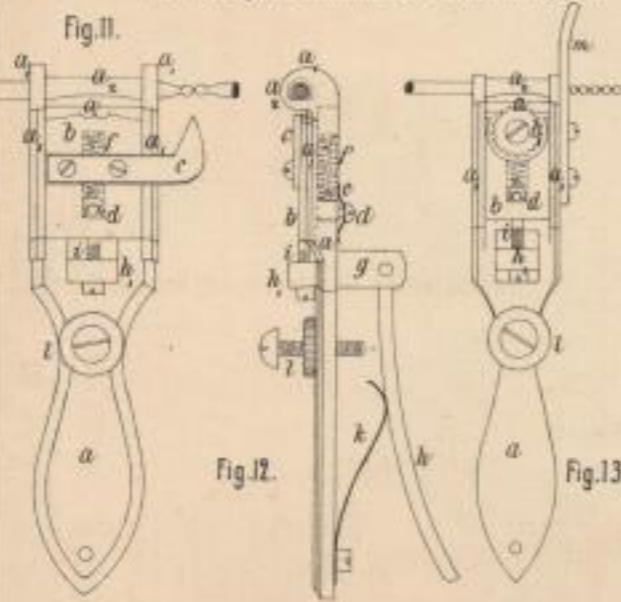

Locomotivkesseln. (7-10)

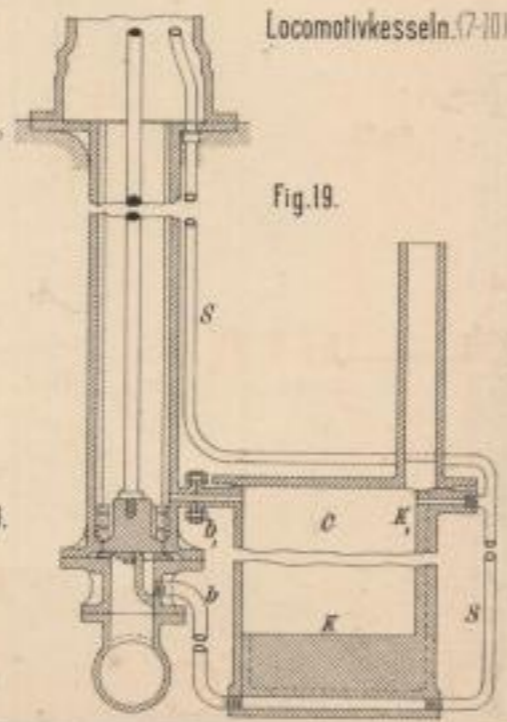

Ad. Borum. (20 u. 21)

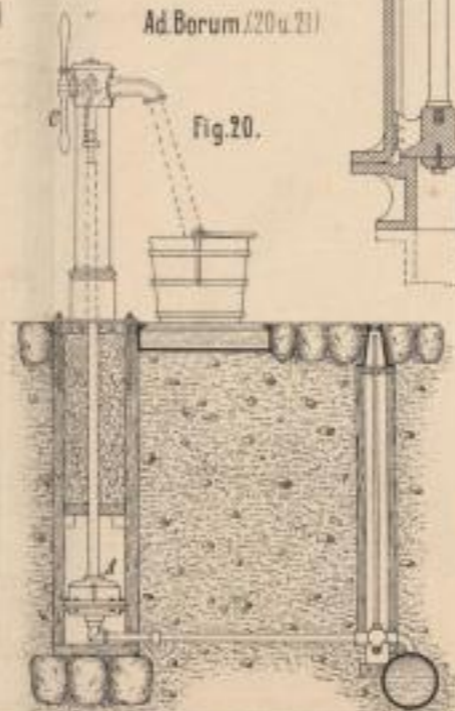

Hasenclever's Herstellung von Hobelmesser. (22 u. 23)

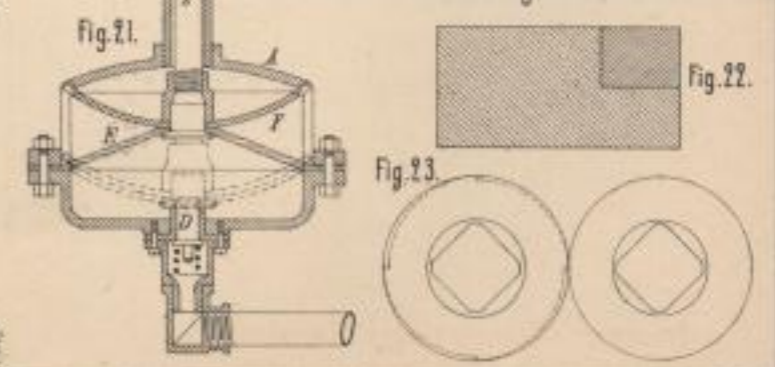

Bruckmann's Schneidezange für Façandraht. (11-13)

Lith. Anst. v. P. Wey. Darmstadt

Neuere Apparate zur Herstellung von Spiritus. (1-8)

G. Siegler. (1u.2)

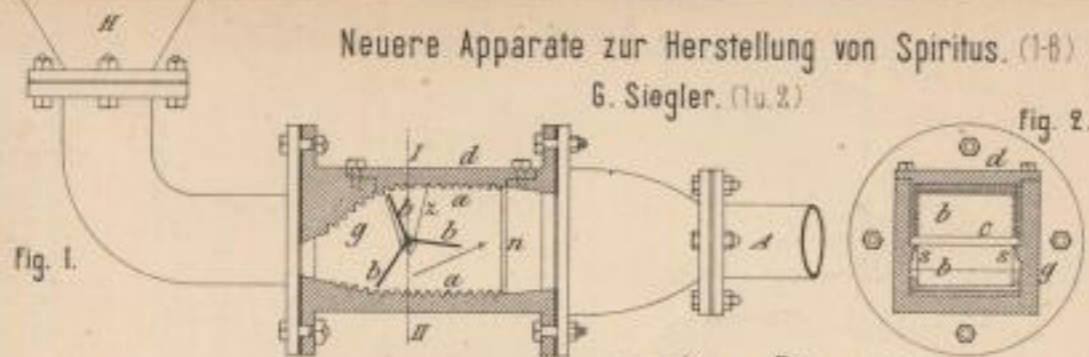

G. E. Marshall's Kocher für Zellstoff. (12)

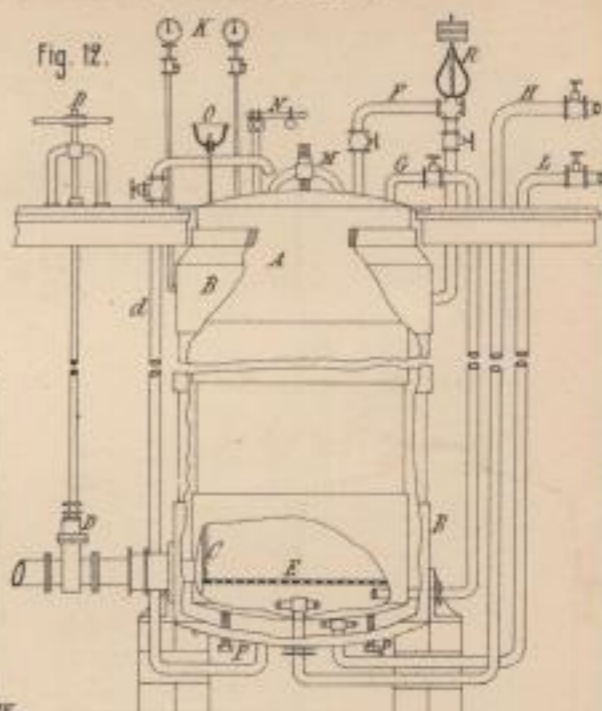

Venuleth und Ellenberger. (4)

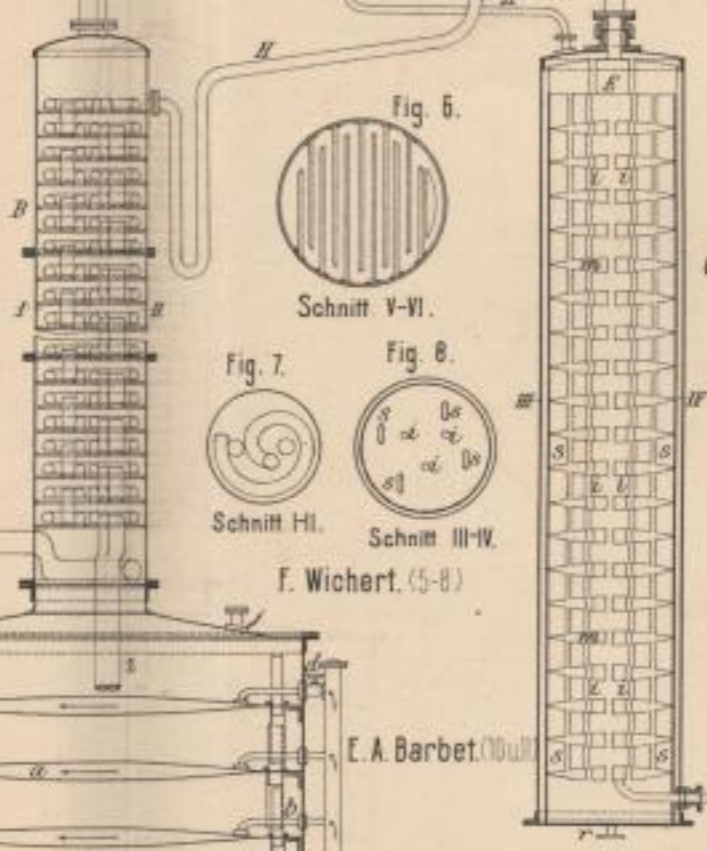
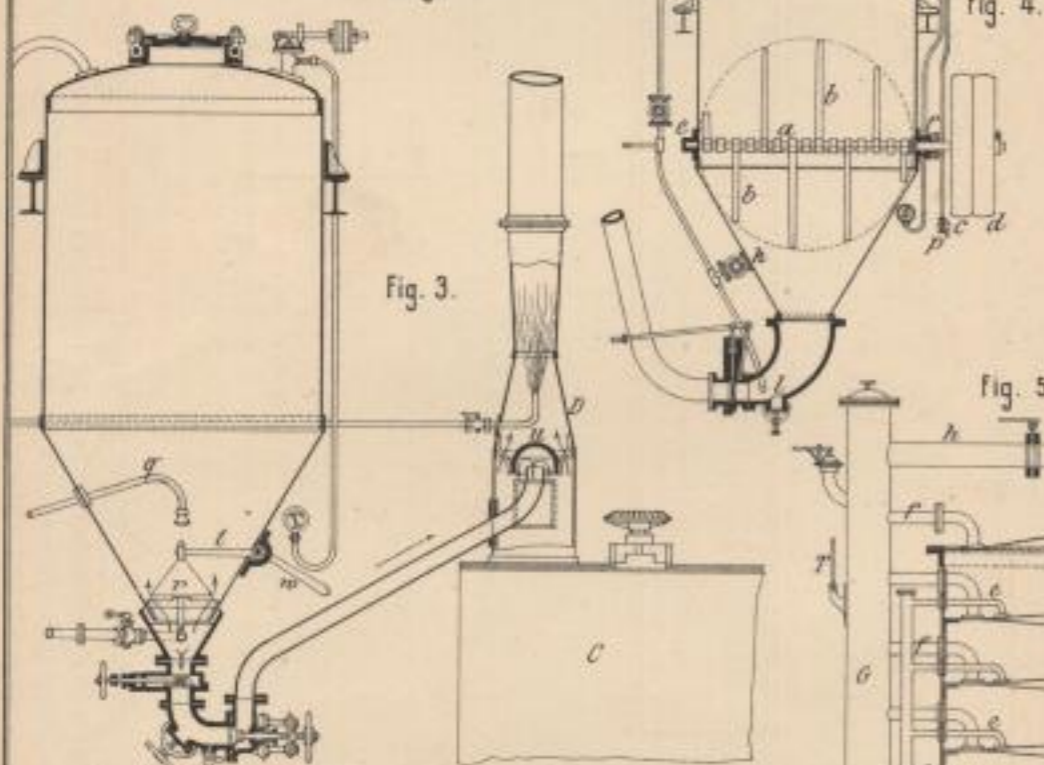

Schnitt V-VI.

Fig. 7.

Fig. 8.

Schnitt HI.

Schnitt III-IV.

F. Wichert. (5-8)

J. Plischke und C. Weigel. (3)

J. Fleury. (9)

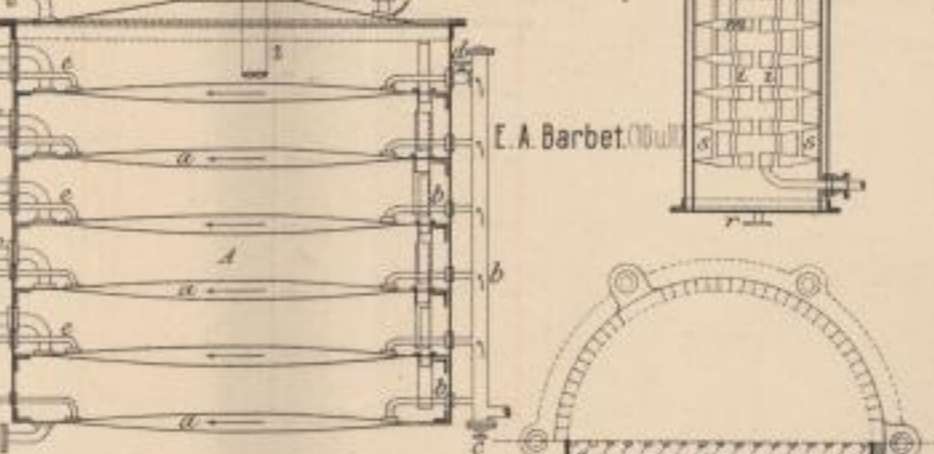
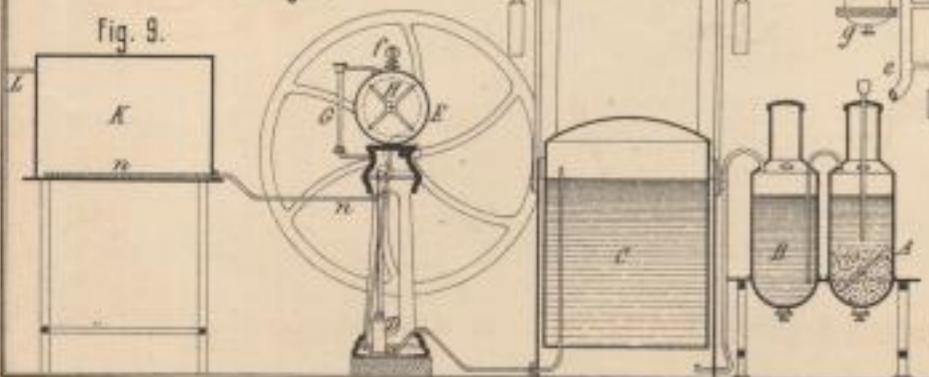

L. C. Wolff's Apparat zum Anzeigen, Messen und Reguliren von Druck-

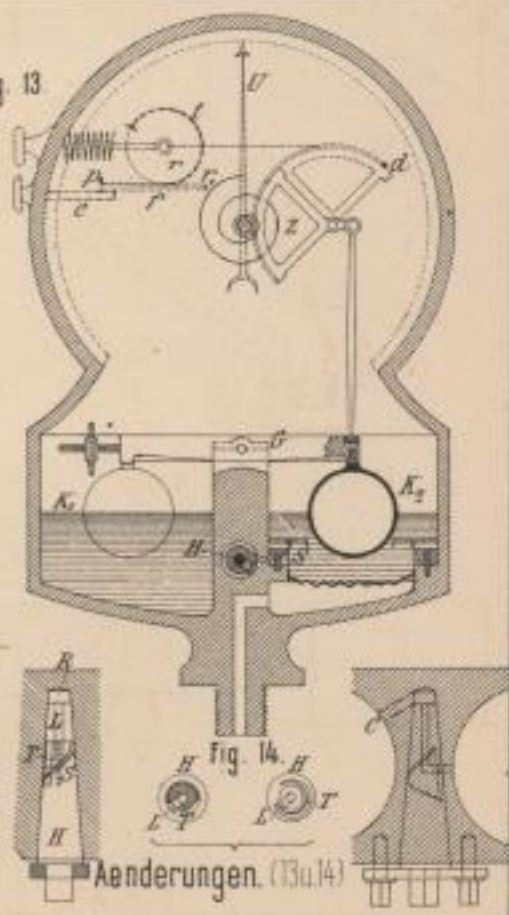

Aenderungen. (13u.14)

Lehr. Anst. v. P. Würtz, Darmstadt.

Armington's Dampfmaschine. (1-7)

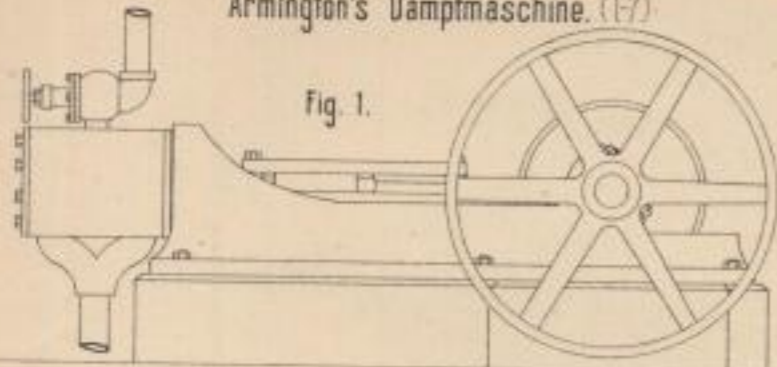

Fig. 1.

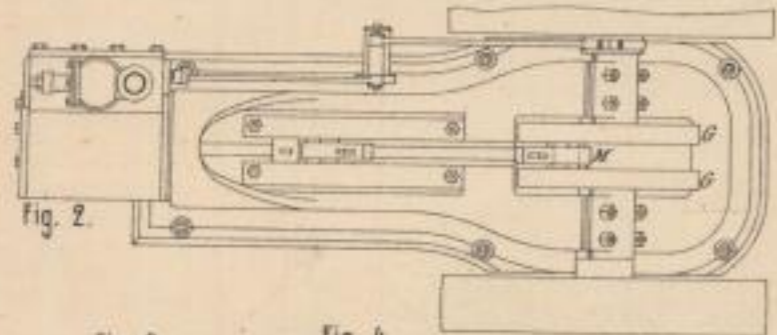

Fig. 2.



Fig. 3.

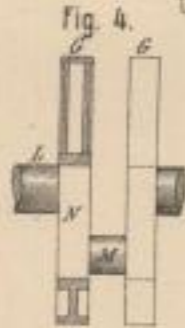

Fig. 4.



Fig. 5.

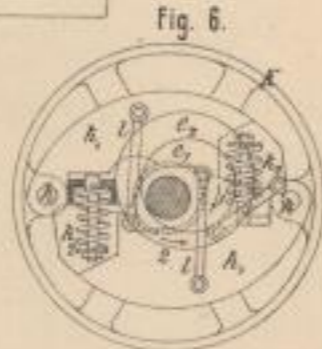

Fig. 6.

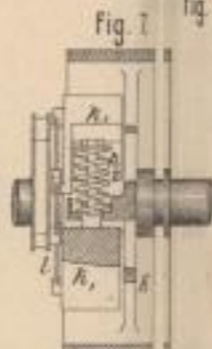

Fig. 7.

Dreyer, Rosenkranz und Droop's Absperrventil. (8-10)

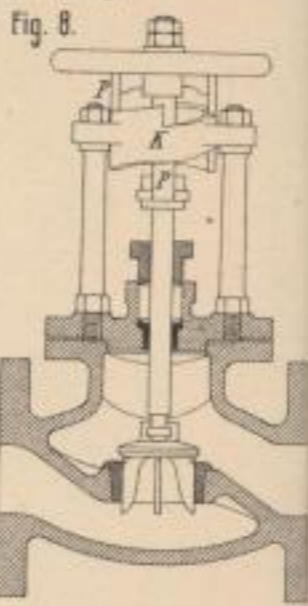

Fig. 8.

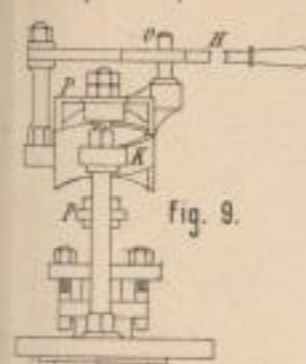

Fig. 9.

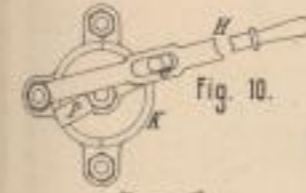

Fig. 10.

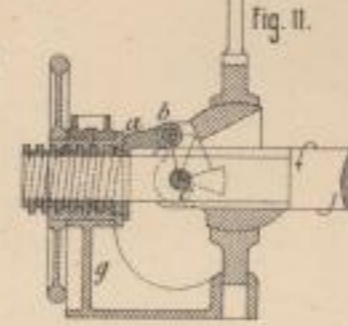

Fig. 11.



Fig. 12.

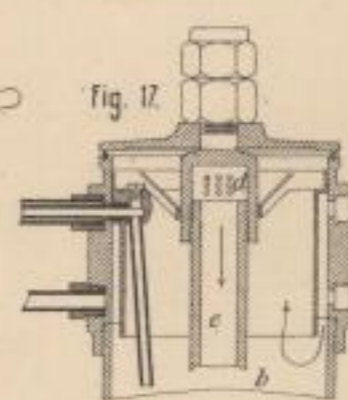

Fig. 17.

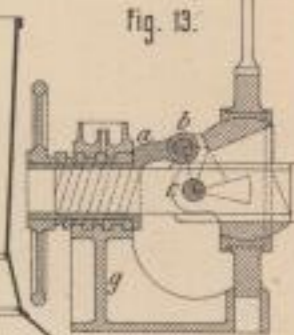

Fig. 13.

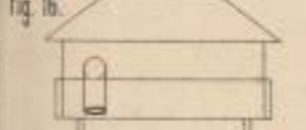

Fig. 16.

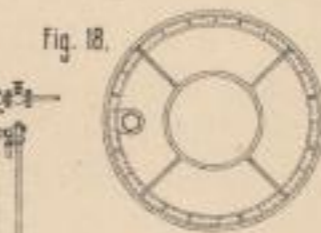

Fig. 18.

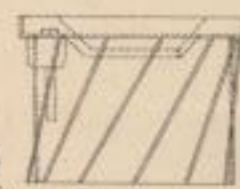

Fig. 19.

Tripier's kugelförmiges Excenter. (11-13)

Fig. 20.

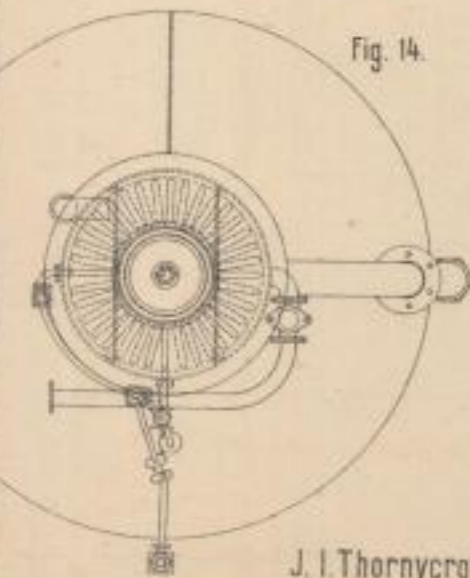
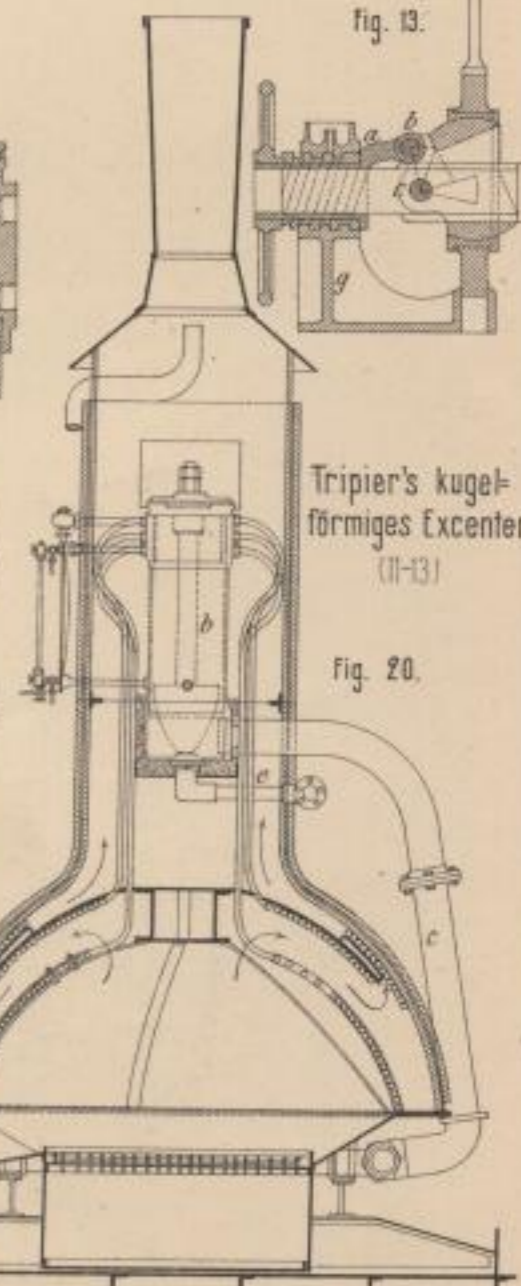

Fig. 14.

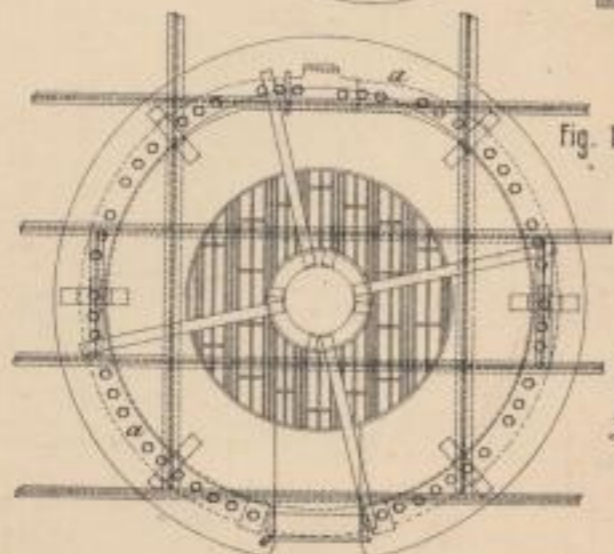

Fig. 15.

J. I. Thornycroft's Wasserröhrenkessel. (14-20)

Lith. Anst. v. F. W. W. Wilmstadt.

Neuere Filterpressen-Verschlüsse. (1-14.)

Fig. 1. Joh. Fritsche. (1 u. 2.)

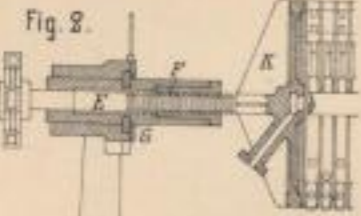
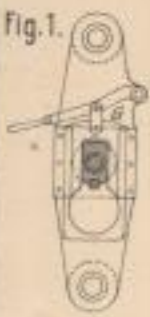

Joh. Kroog. (3.)

Fig. 3.

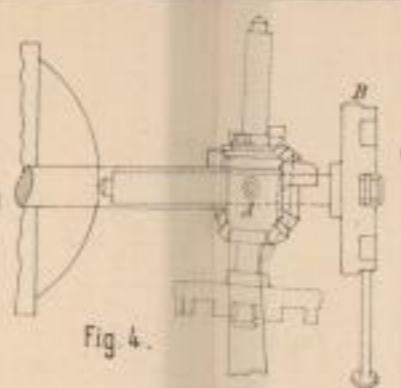
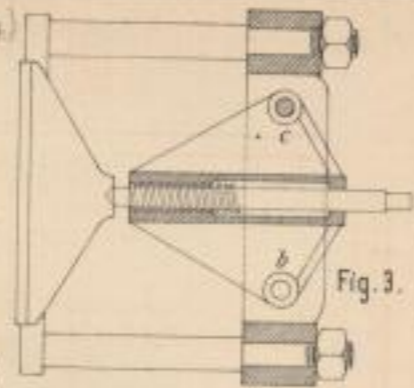
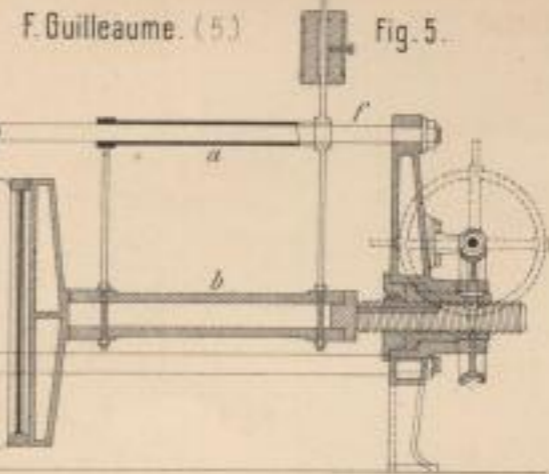

Fig. 4.



F. Guilleaume. (5.) Fig. 5.

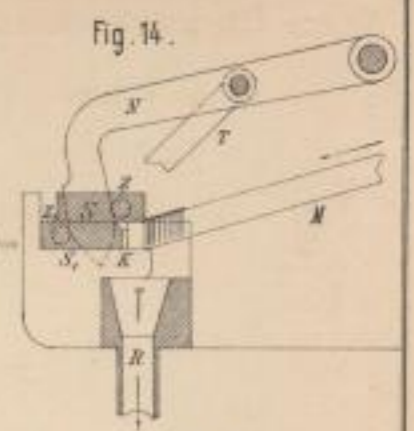

Fig. 14.

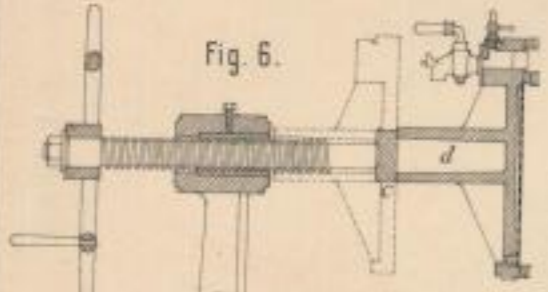

Fig. 6.

Fr. Seele und Comp. (6.)

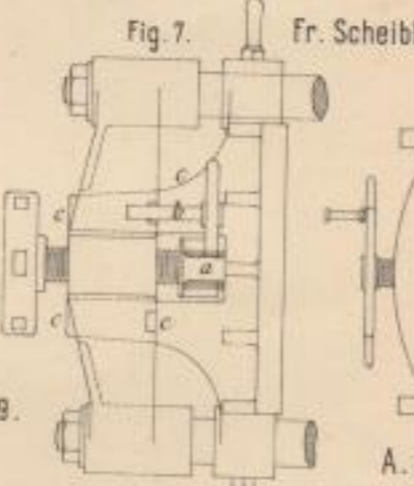

Fig. 7. Fr. Scheibler. (7.)

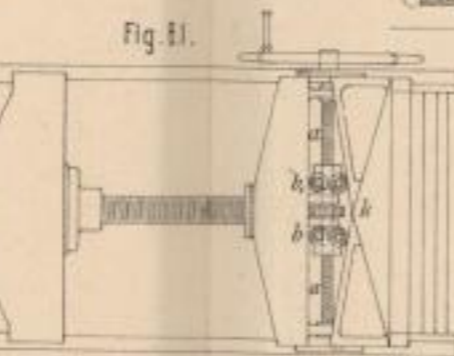

Fig. 8.

A. Dehne. (4, 9 u. 10.) E. Hertel. (8.)

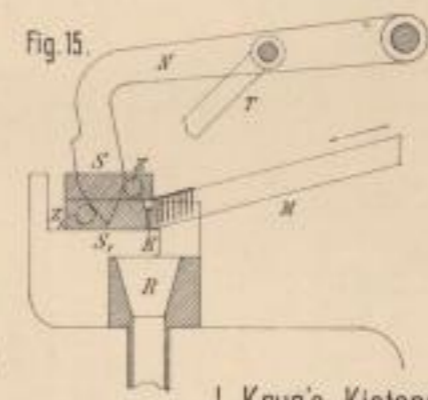

Fig. 15.

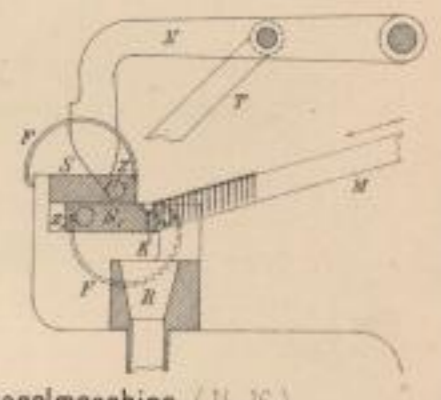

Fig. 16.

J. Krug's Kistennagelmaschine. (14-16.)

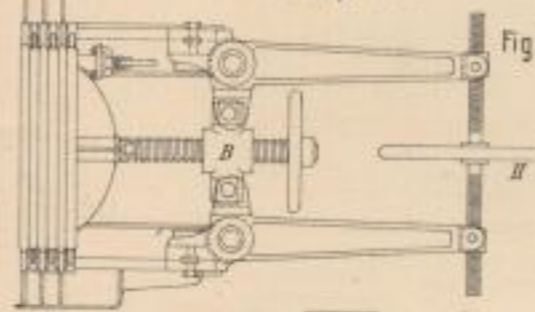

Fig. 9.

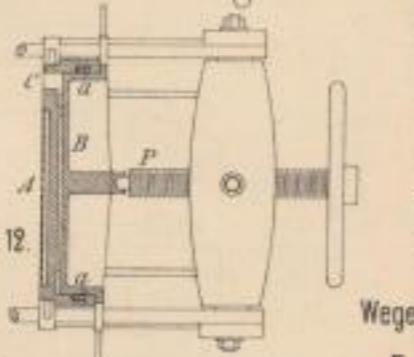

Fig. 12.

Wegelin und Hübner. (11.)

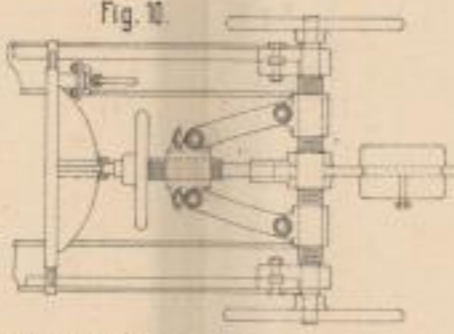

Fig. 10.



Fig. 17.

F. Uiffers' Reaktionspropeller. (17-20.)

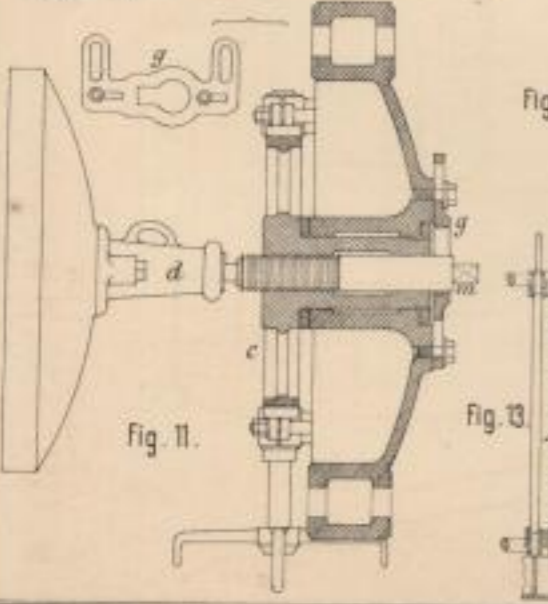

Fig. 11.

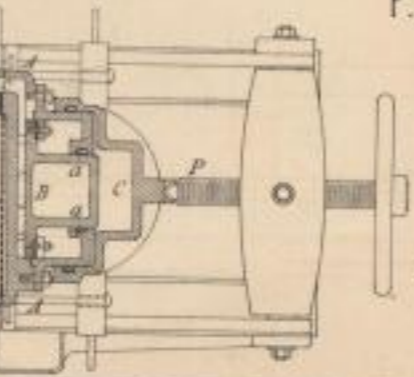

Fig. 13.

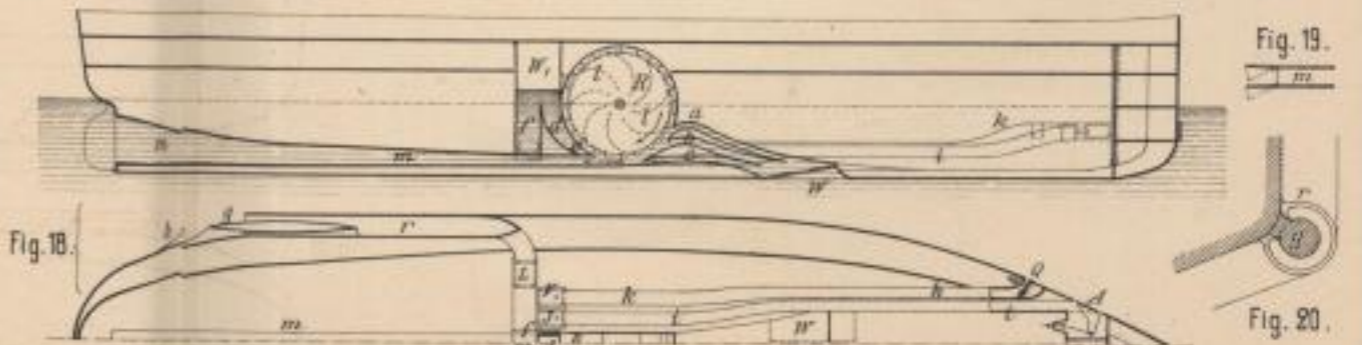
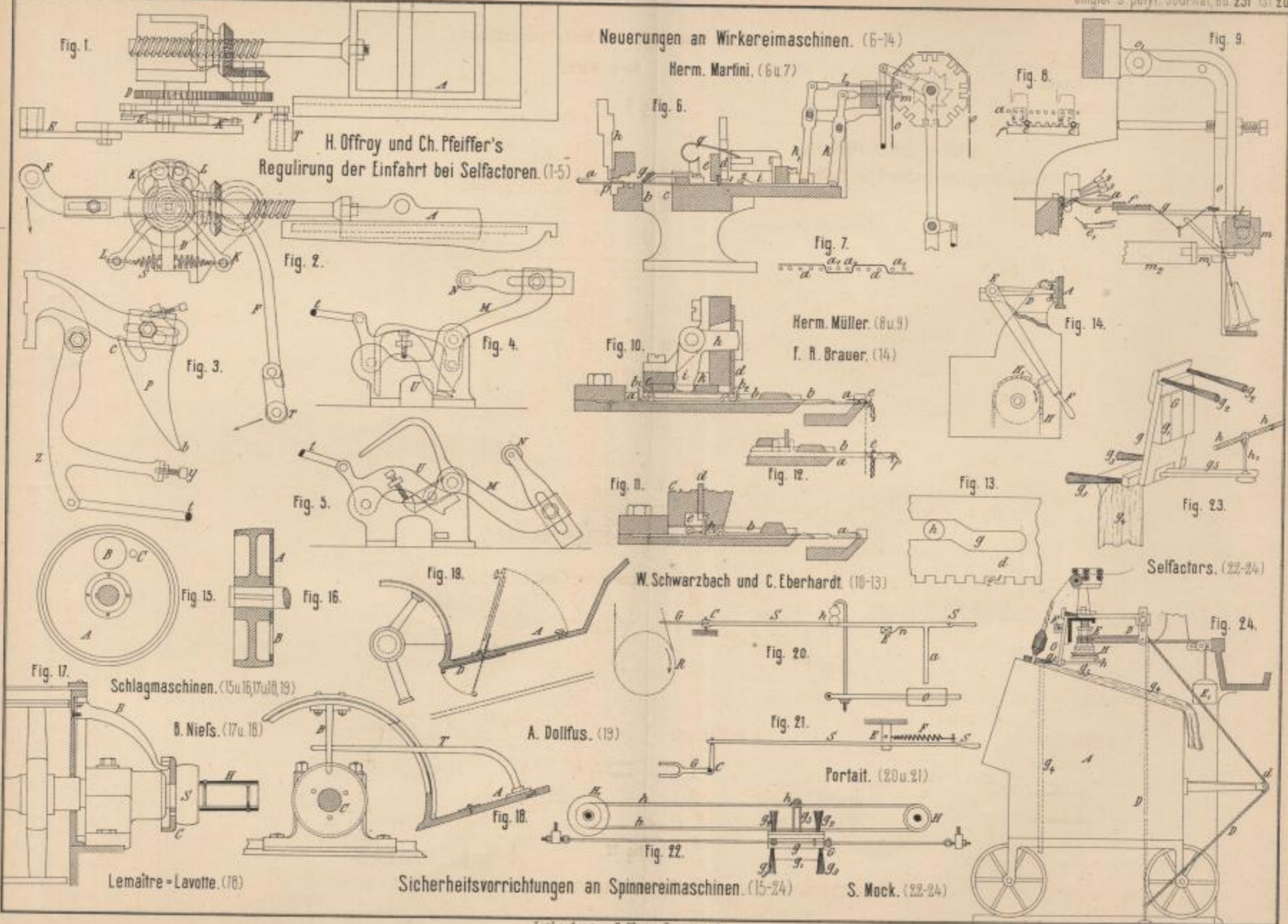

Fig. 18.

Fig. 19.

Fig. 20.

100. Ausd. v. P. Wirtz, Darmstadt.



Lith. Anst. v. F. Wörts, Darmstadt.

Ph. Hirschel. (1)

Ueber Kesselsteinbildung und deren Verhütung. (1-8)

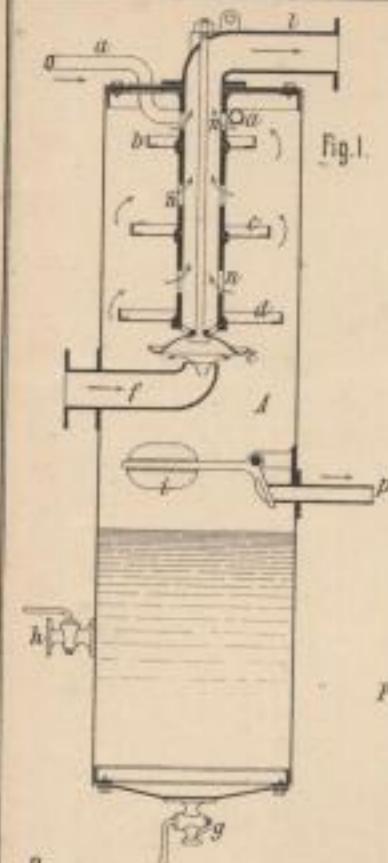

Fig. 1.

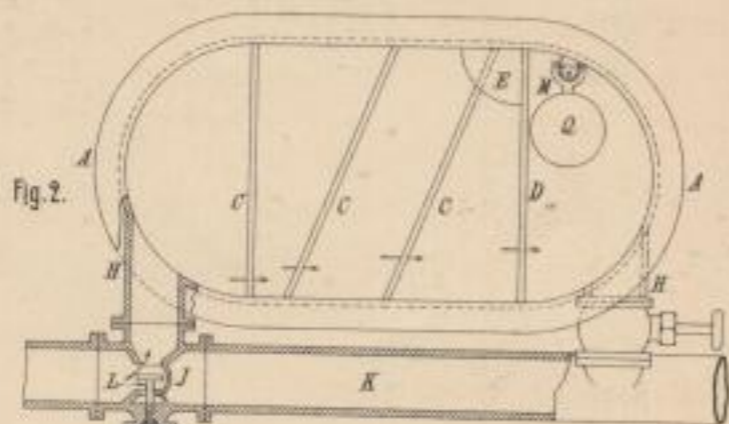

Fig. 2.

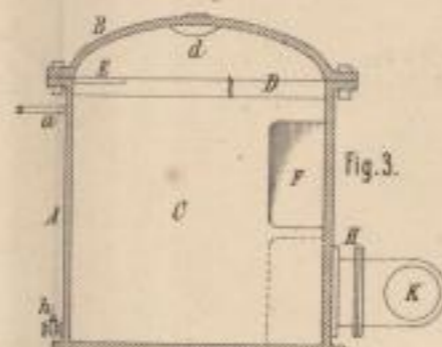

Fig. 3.

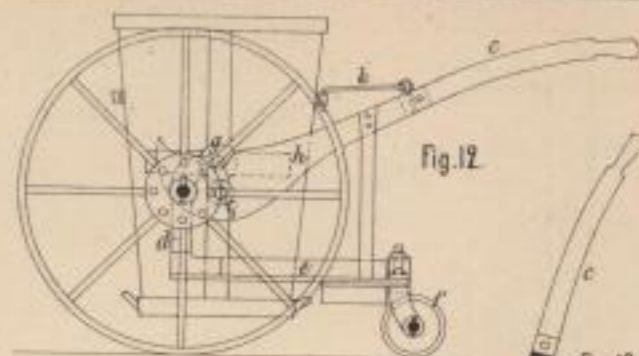

Fig. 12.

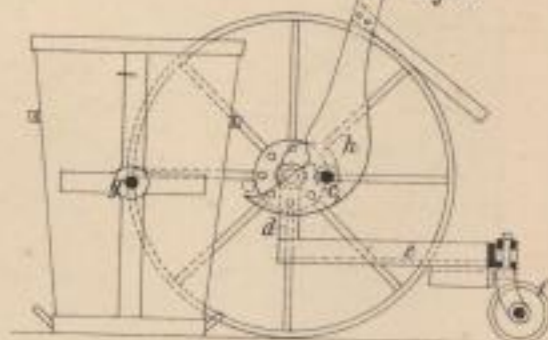

Fig. 13.

J. Brandt und v. Nawrocki's Transportwagen. (12 u. 13)

D. Waß und L. Katzenstein. (2-4)

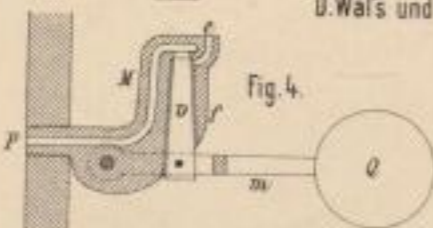

Fig. 4.

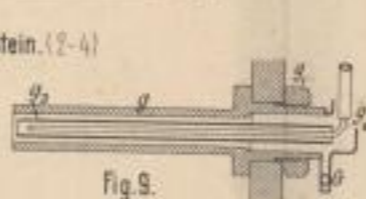

Fig. 9.

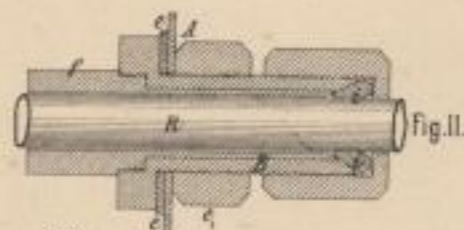

Fig. 11.

A. Mitscherlich's Herstellung von Sulfidstoff. (9-11)

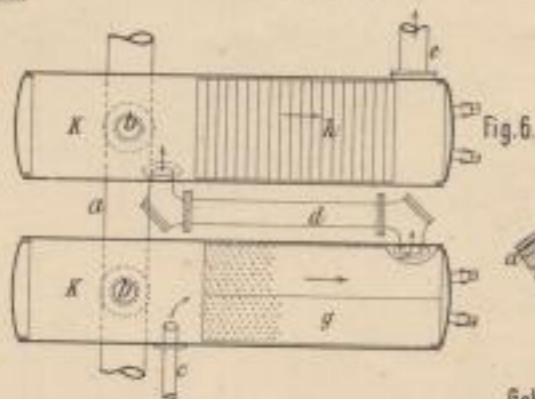

Fig. 6.

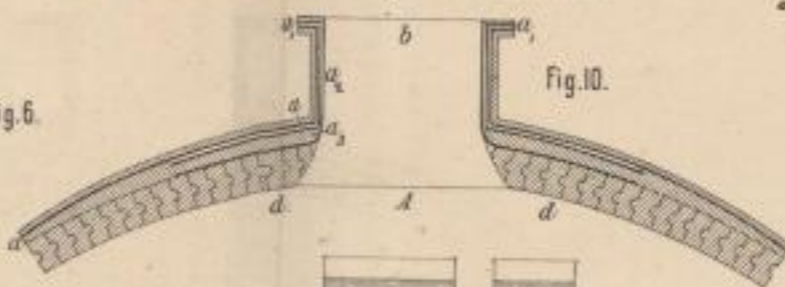

Fig. 10.

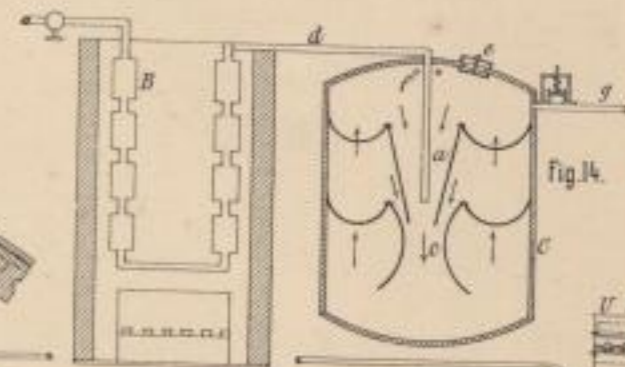

Fig. 14.

Gebr. Stollwerck. (6-8)

Stewart. (15)

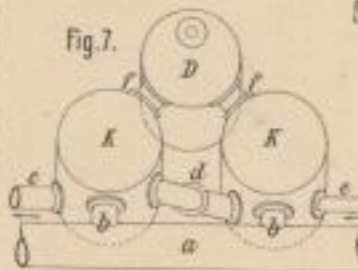

Fig. 7.

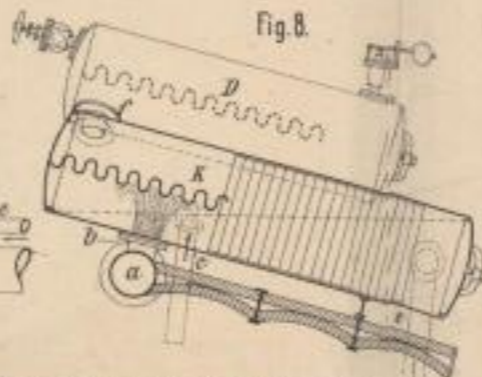

Fig. 8.

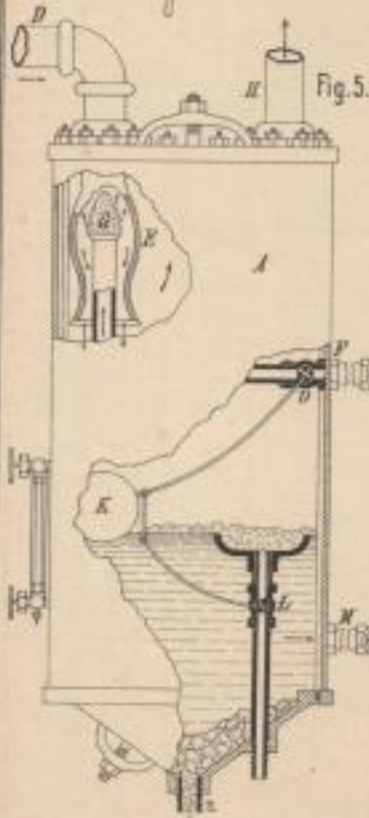

Fig. 5.

Violette und Buisine's bez. W. West's Verarbeitung von Fetten. (14 bez 15)

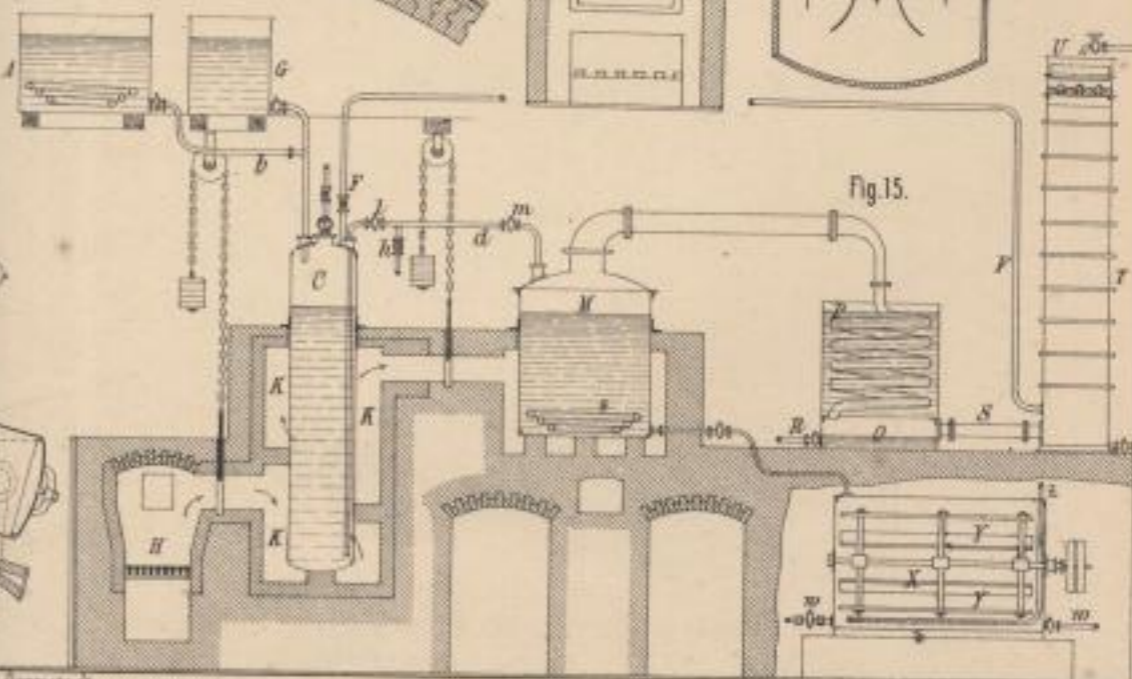
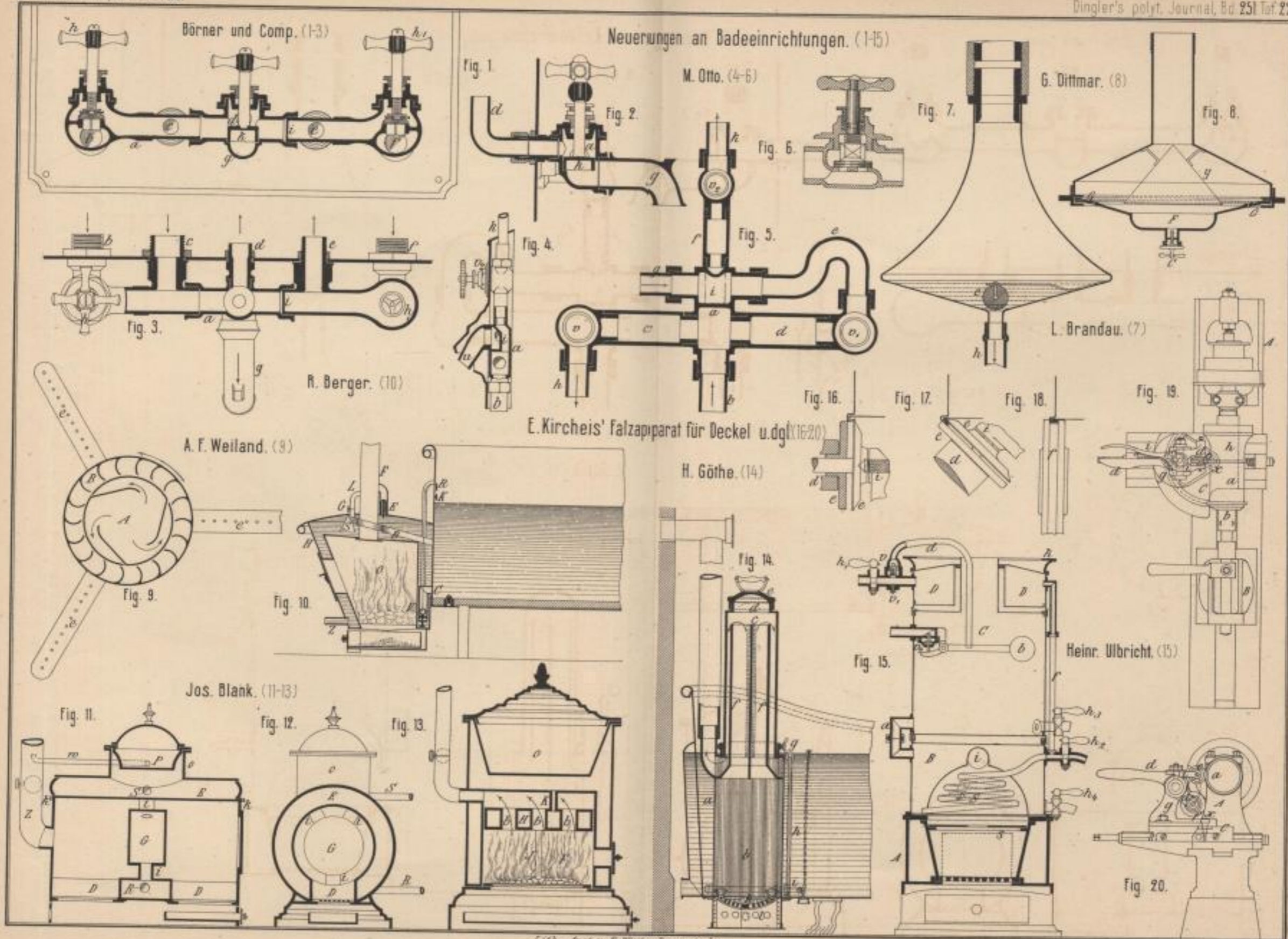

Fig. 15.

Lith. Anst. v. F. Wink. Darmstadt



Verf. Inst. v. F. Würten, Darmstadt.

Neuerungen an Wirkereimaschinen. (1-16)

G. F. Grofser. (15 u. 16)

G. Widemann's Herstellung von Gazegewebe. (17-20)

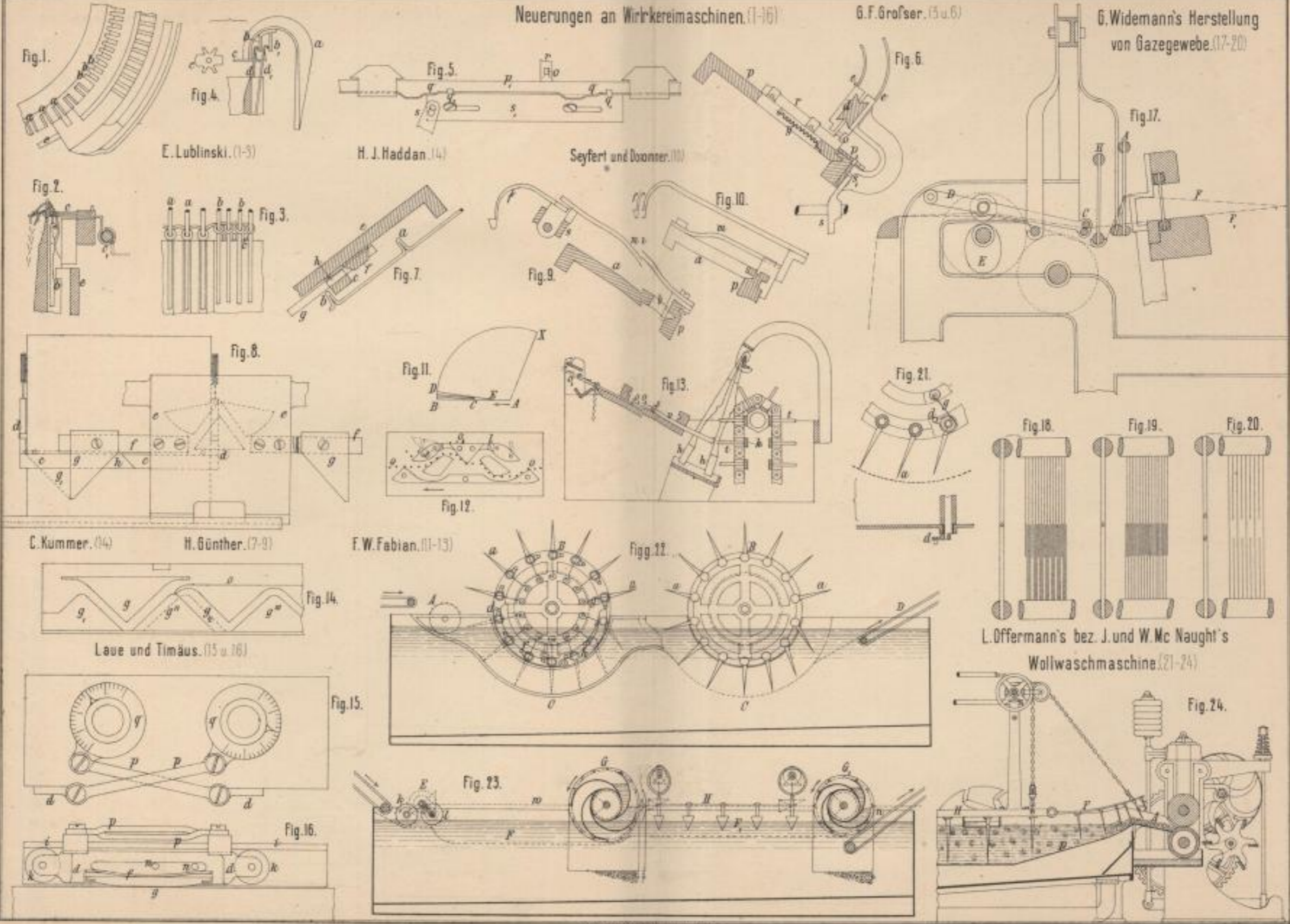

E. Lublinski. (1-3)

H. J. Haddan. (4)

Seyfert und Doxner. (10)

Fig. 2.

Fig. 3.

Fig. 7.

Fig. 9.

Fig. 10.

Fig. 6.

Fig. 17.

Fig. 8.

Fig. 11.

Fig. 13.

Fig. 21.

Fig. 12.

C. Kummer. (14)

H. Günther. (7-9)

F. W. Fabian. (11-13)

Fig. 18.

Fig. 19.

Fig. 20.



Lave und Timäus. (15 u. 16)

L. Offermann's bez. J. und W. Mc Naught's Wollwaschmaschine. (21-24)

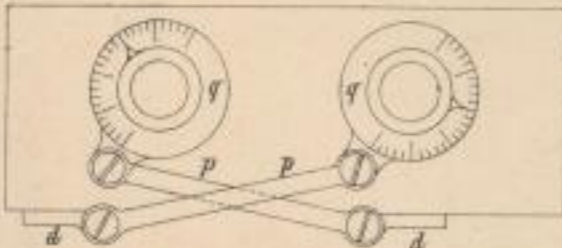

Fig. 15.

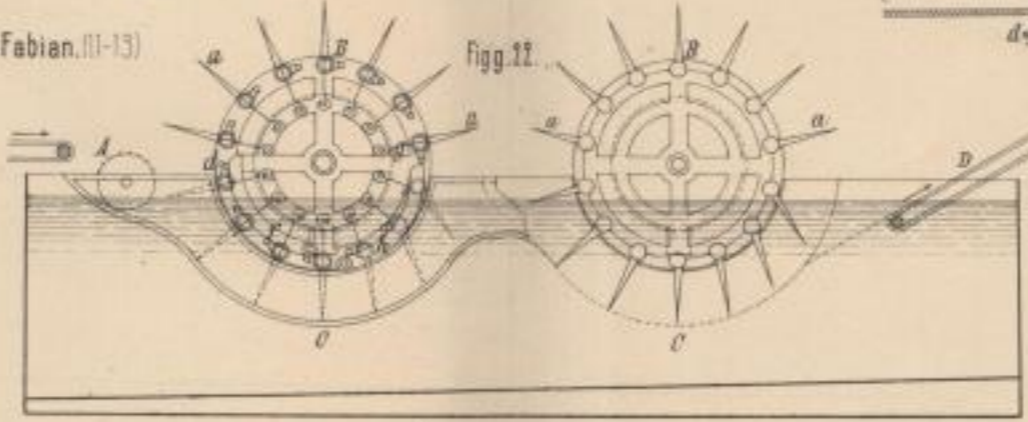

Fig. 22.

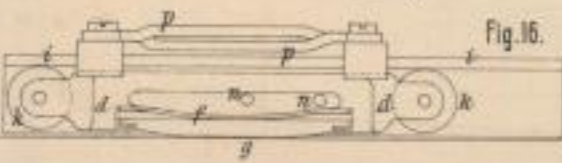

Fig. 16.

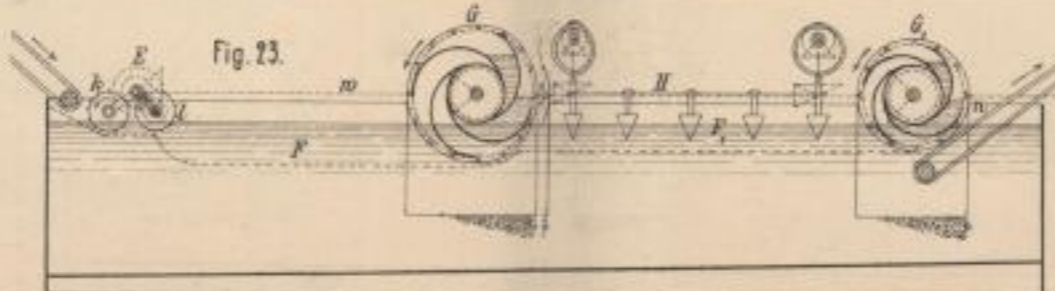

Fig. 23.

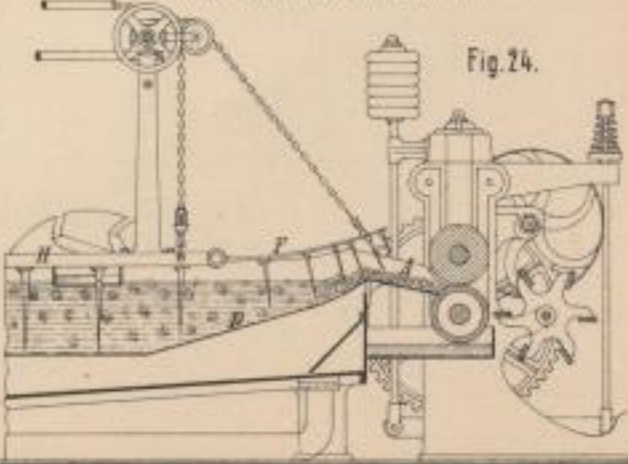

Fig. 24.

Lab. Anst. v. P. W. J. Darmstadt



Neuere Apparate für chemische Fabriken. (1-8)

J. W. Dixon's Wiedergewinnung von Soda. (9u.10)

Fig. 1.

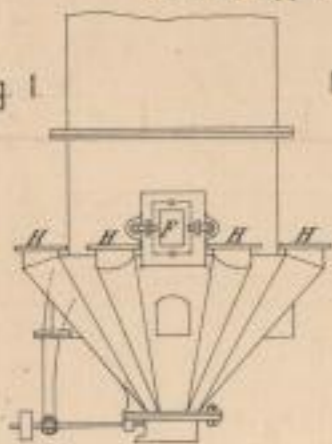

W. Maxwell. (3u.4)

Fig. 2.

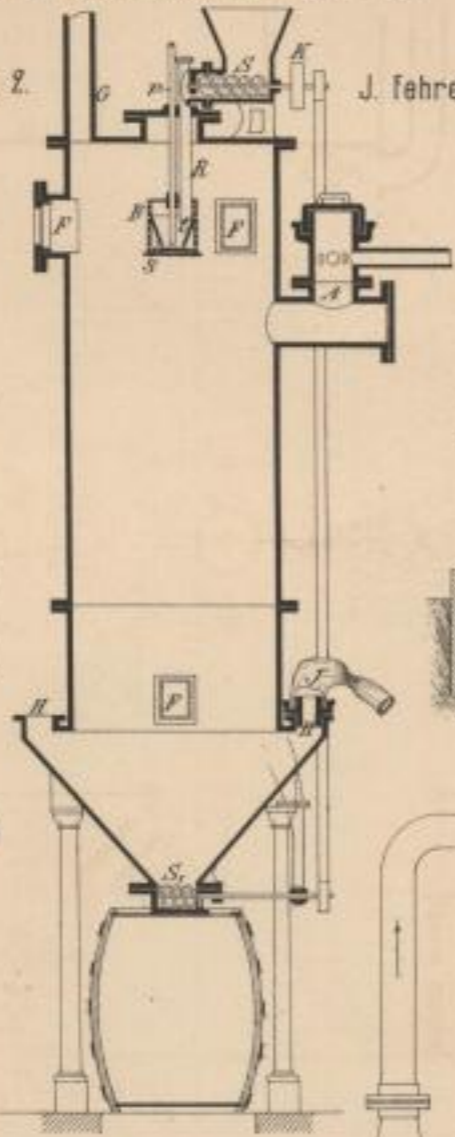

J. Fehres. (1u.2)

Fig. 5.

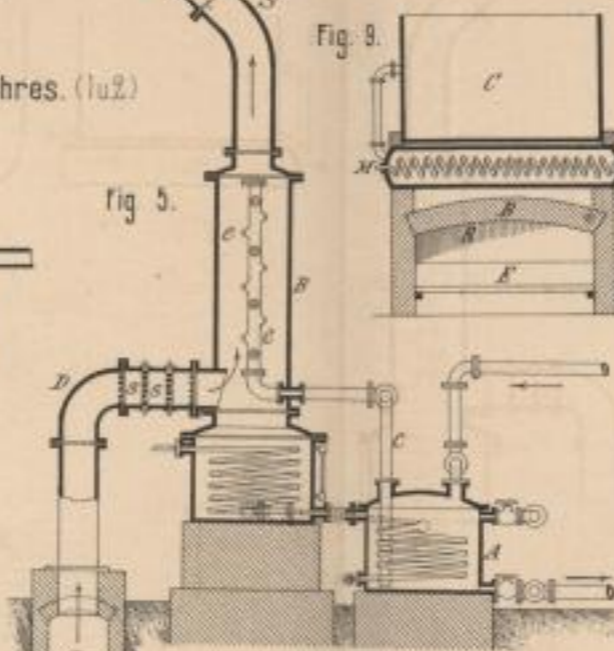

H. Neumeyer. (5u.6)

Fig. 7.

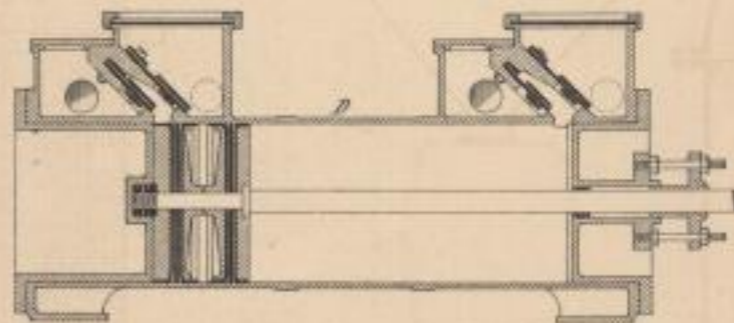

C. Heckmann. (7u.8)

Fig. 8.

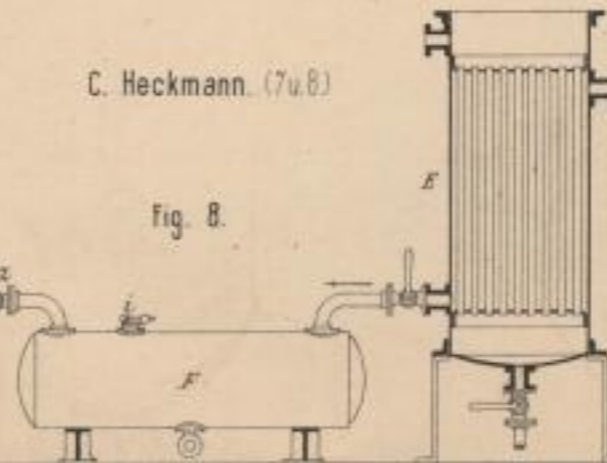

Fig. 9.

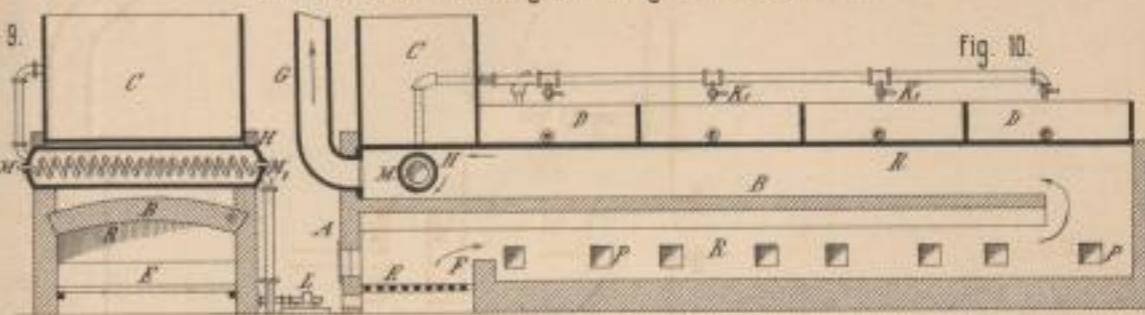

Fig. 10.

Fig. 3.

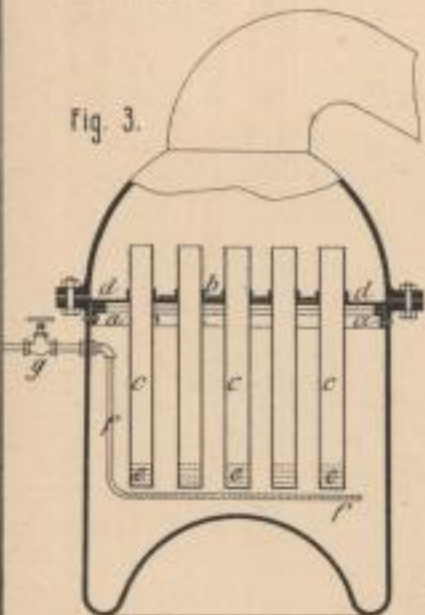

Fig. 4.

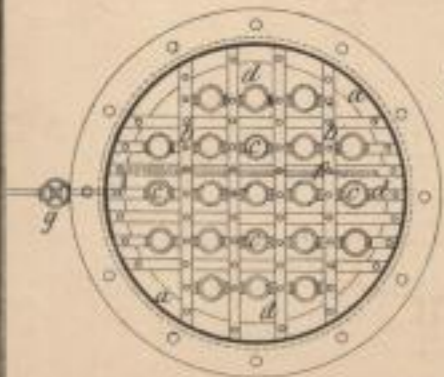
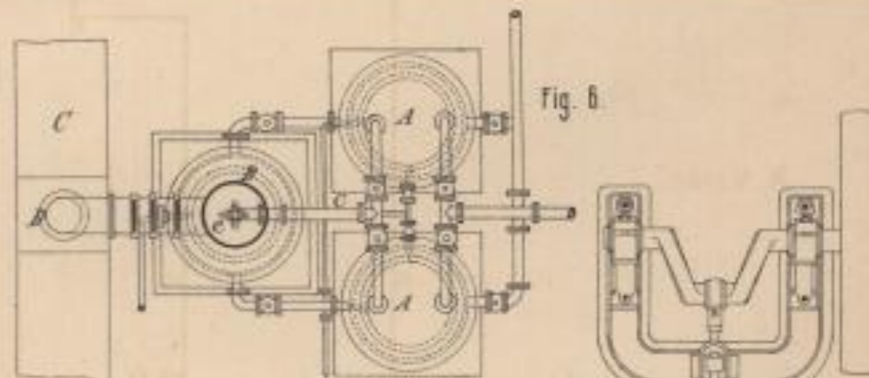

Fig. 6.



Lith. Anst. v. F. Wirtz, Darmstadt.

Neuere Kolbenschieber für Dampfmaschinen. (1-14)

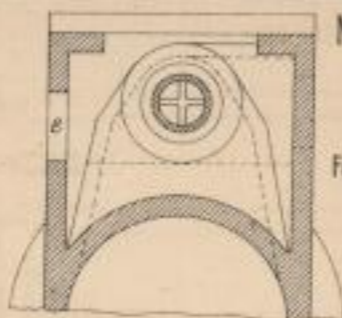
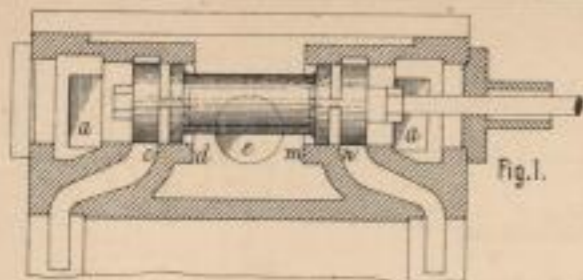

Fig. 2.

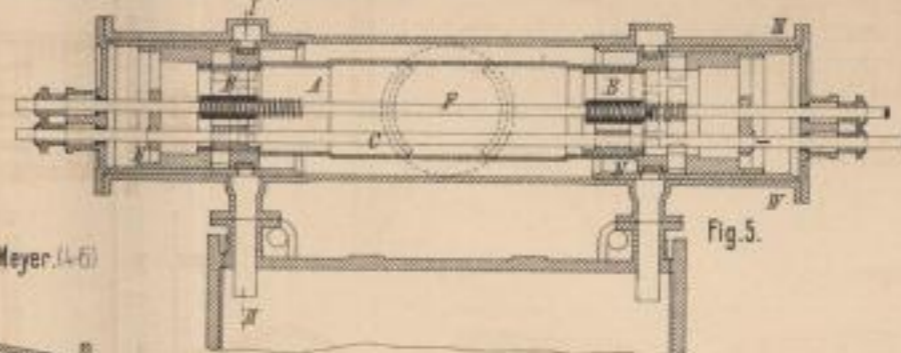

Fig. 5.

Meyer (4-6)

P. Armington. (1-3)

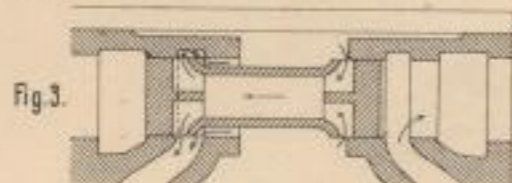

Fig. 3.

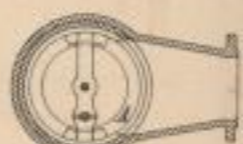

Fig. 4.

Schnitt III-IV.

Ehrhardt und Sehmmer. (9 u. 10)

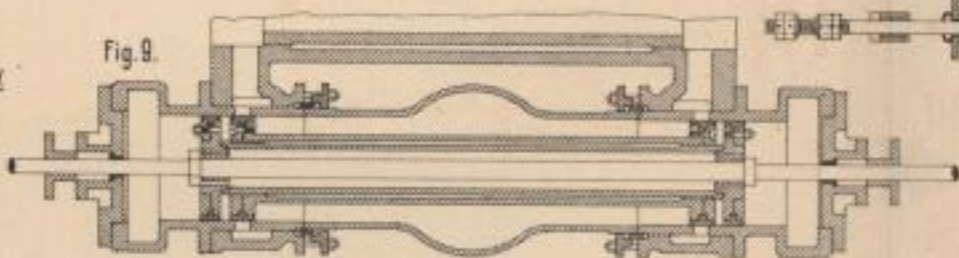
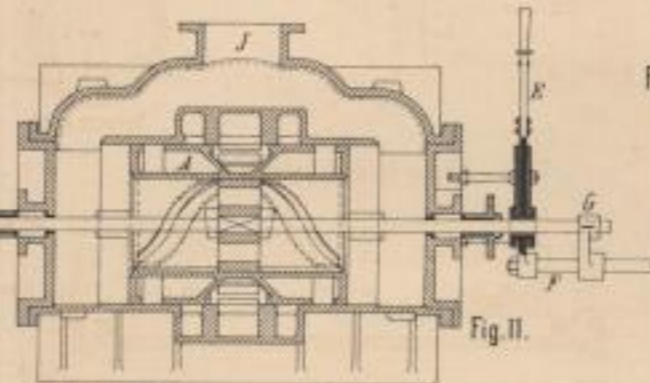

Fig. 9.



Rider. (7 u. 8, 11-14)

Fig. 12.

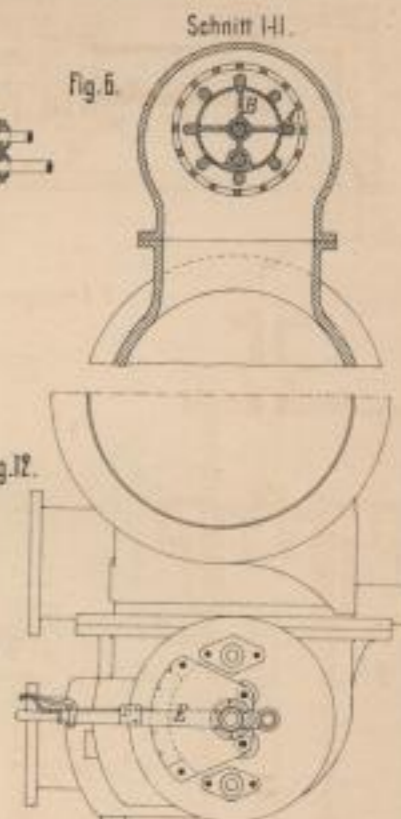

Fig. 6.

Schnitt I-II.

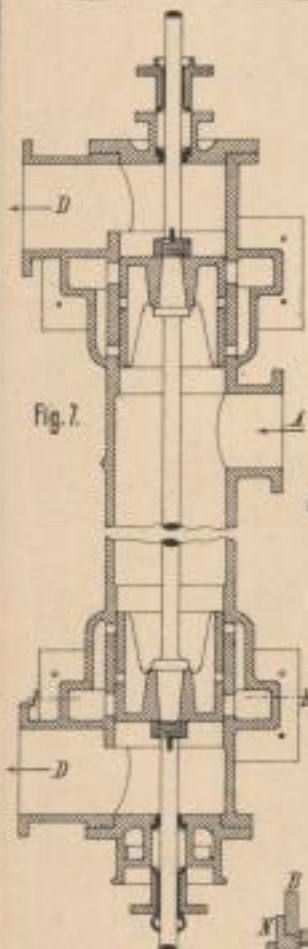
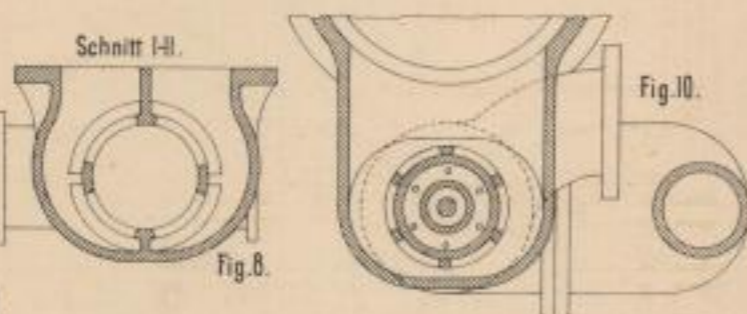

Fig. 7.



Schnitt I-II.

Fig. 8.

Fig. 10.

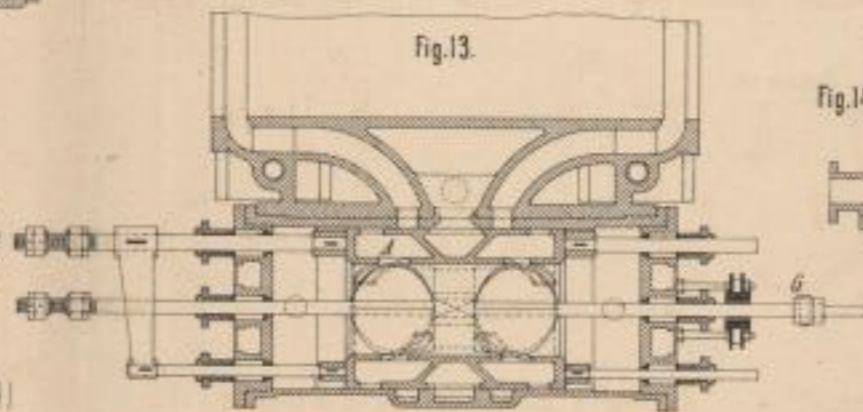
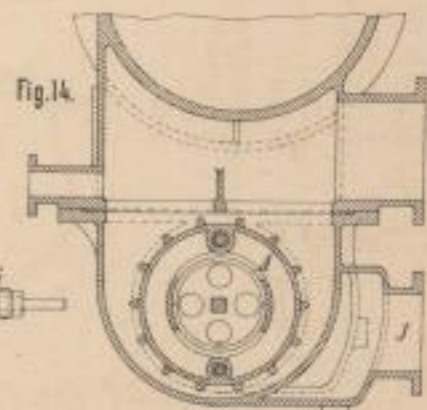

Fig. 13.

Fig. 14.



Kirchhoff's Bremskuppelung für Drehbänke. (15-19)

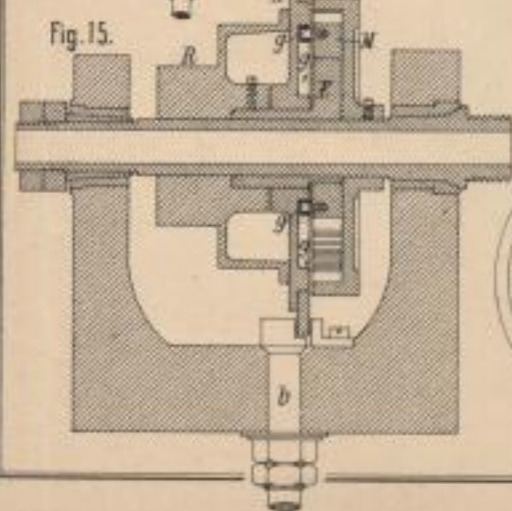

Fig. 15.

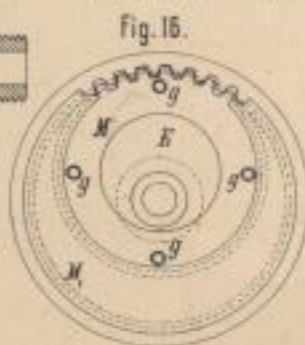

Fig. 16.

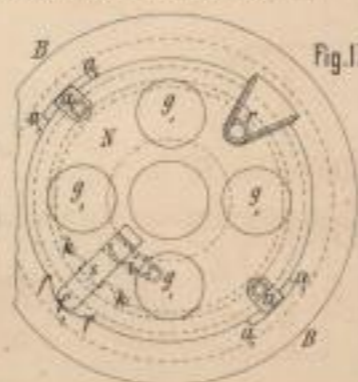

Fig. 17.

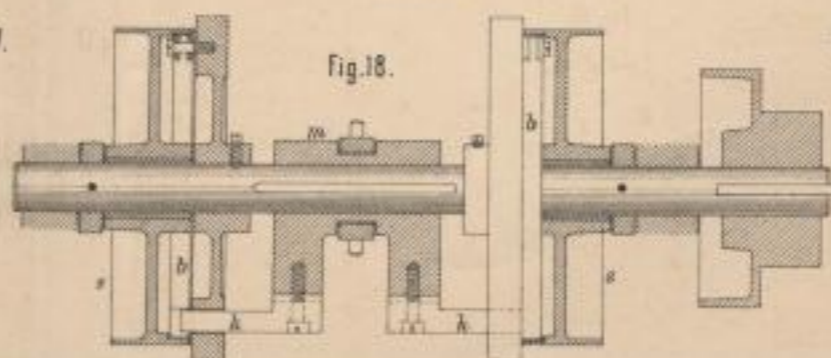
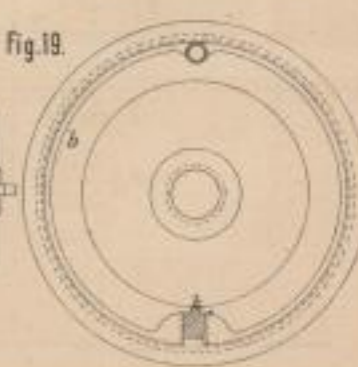
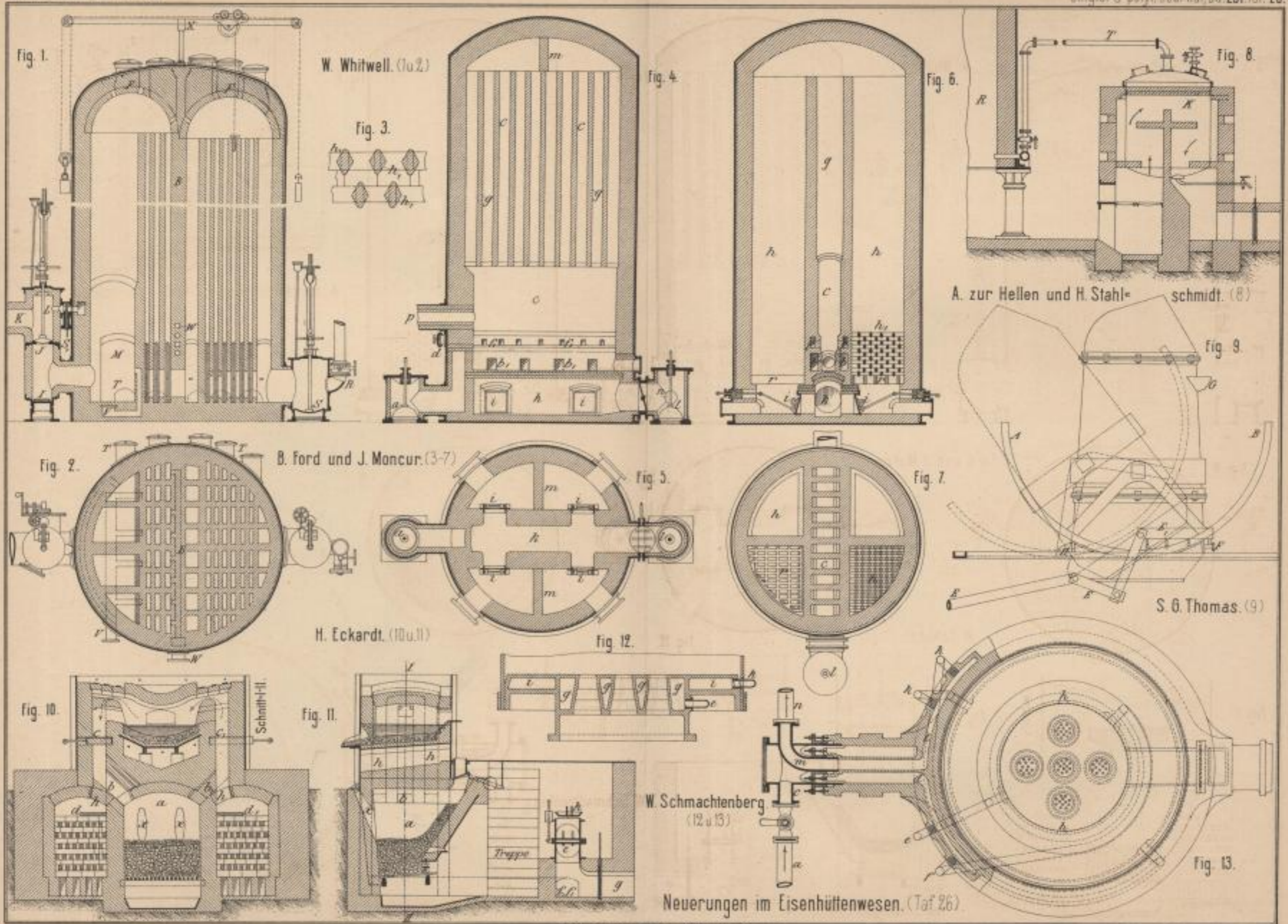

Fig. 18.

Fig. 19.



Lab. Anst. v. F. Wess. Darmstadt



Neuerungen im Eisenhüttenwesen. (Taf. 26)

Lith. Anst. v. P. Wille, Darmstadt.

Neuere Gasbrenner mit Vorwärmung der Verbrennungsluft. (1-12)

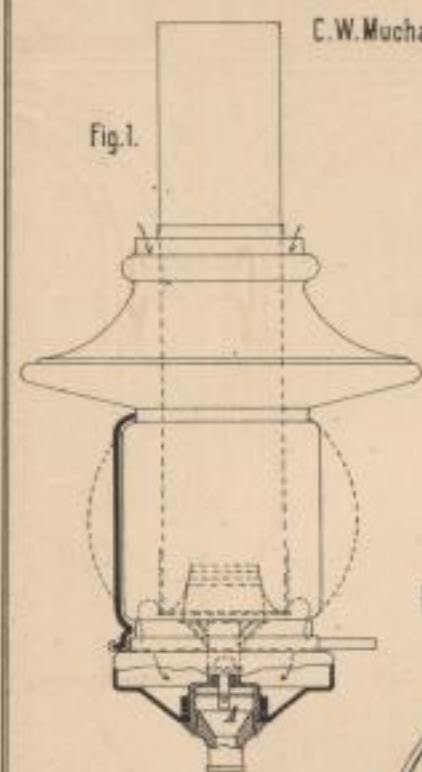

Fig. 1.

C. W. Muchall. (1)

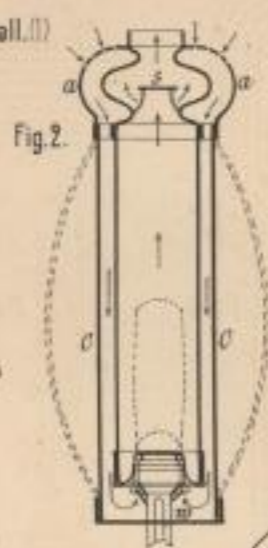

Fig. 2.

K. Schall. (2)

Fig. 3.



Fig. 4.

F. Fritz. (3 u. 4)

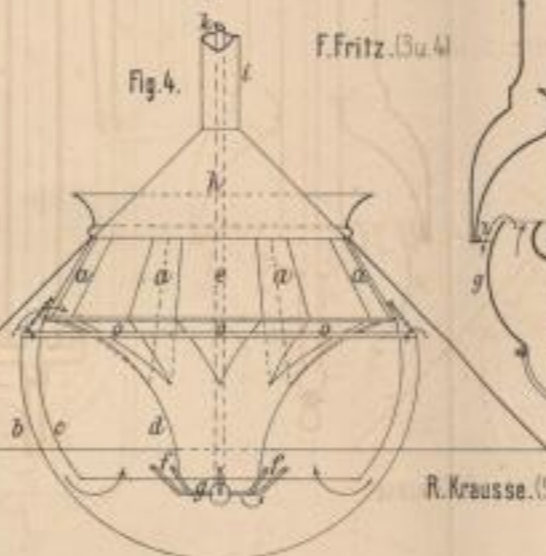

R. Krause. (9)

Fig. 9.

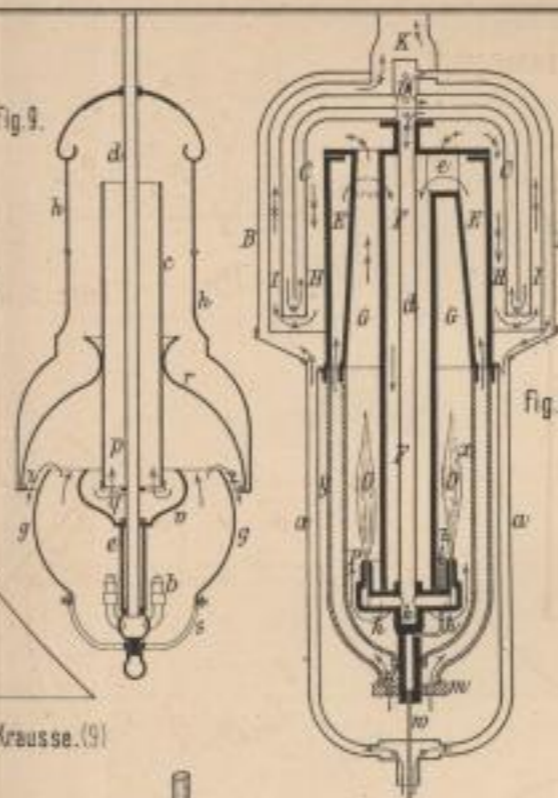
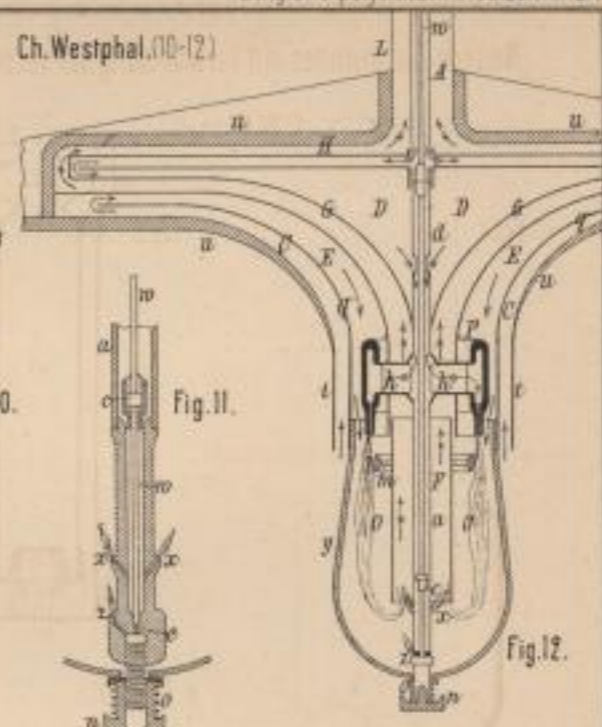

Fig. 10.

Ch. Westphal. (10-12)



Luft Gas Verbrennungsprodukte

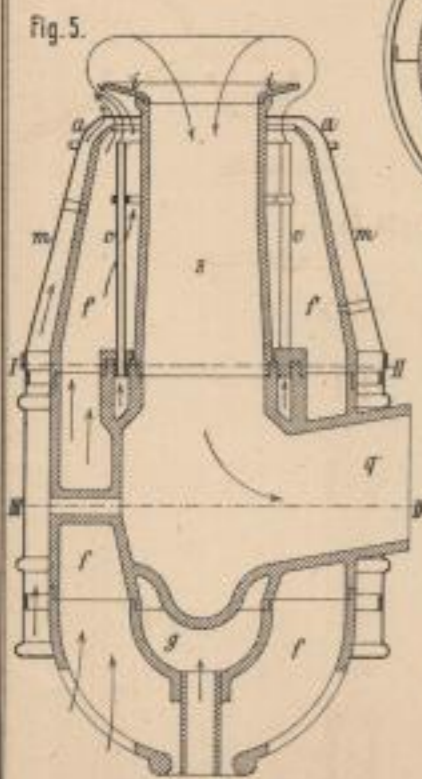

Fig. 5.



Fig. 6.

Fr. Siemens. (5-8)

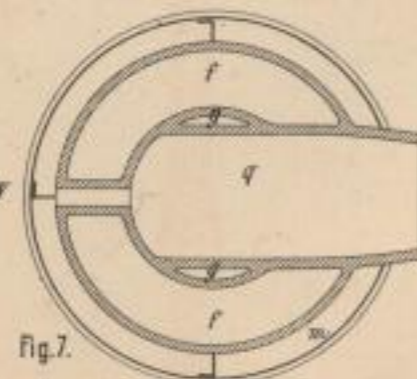

Fig. 7.

Schnitt III-IV

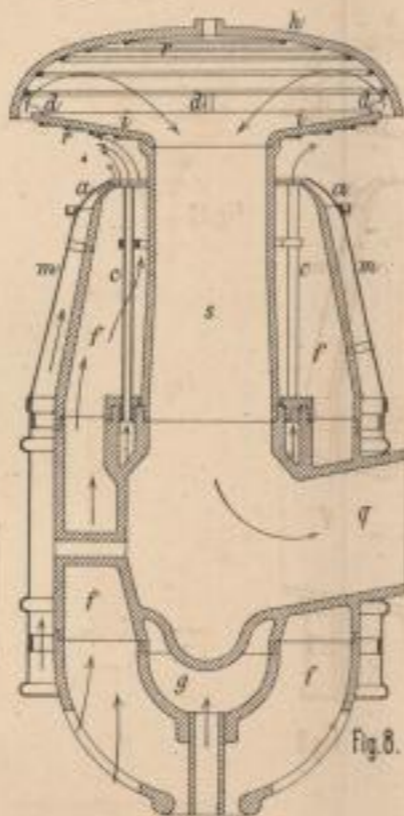

Fig. 8.



Fig. 13.



Fig. 16.



Fig. 17.

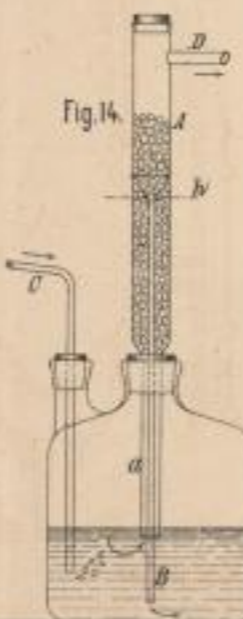

Fig. 14.

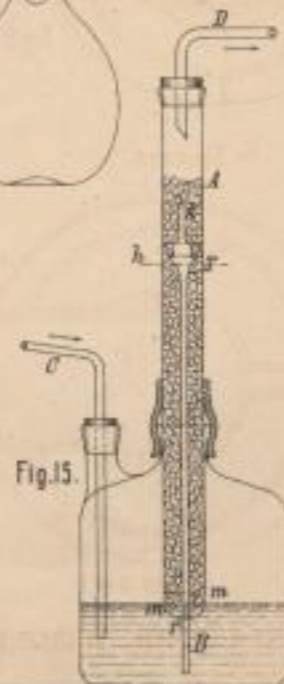

Fig. 15.

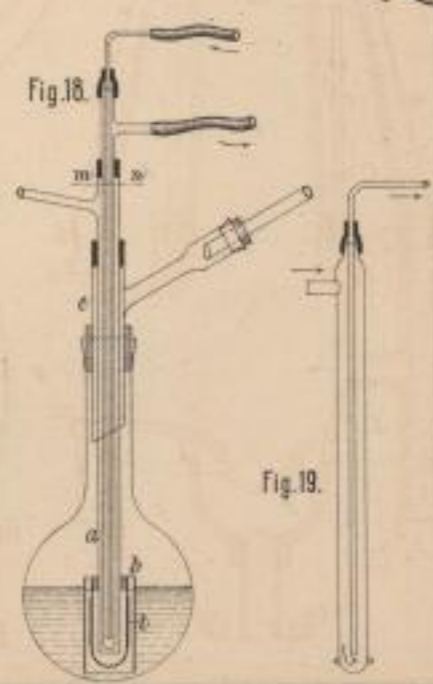

Fig. 18.

Fig. 19.

J. Walter's Apparate für chemische Laboratorien. (13-19)

Lith. Anst. v. F. Wille, Darmstadt.

Hugo Fischer: Ueber Deutung und Genauigkeit von Festigkeitsdiagrammen. (Taf. 28.)

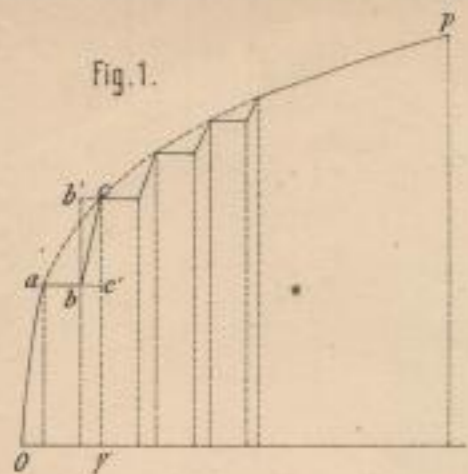

Fig. 1.

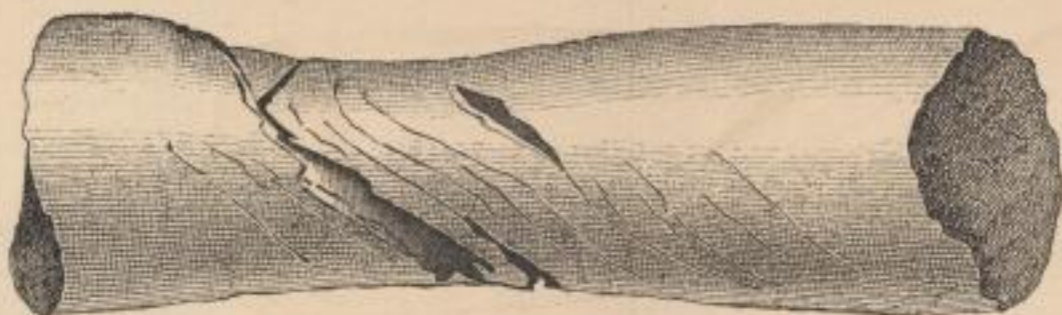

Fig. 5. Plastischer Thon. Natürliche Größe.



Fig. 6. Bleidraht. 11fache Vergrößerung.



Fig. 7. Zindraht. 12fache Vergrößerung.

- 1)  $c = 5,20$
- 2)  $c = 2,26$
- 3)  $c = 1,11$
- 4)  $c = 0,445$
- 5)  $c = 0,203$
- 6)  $c = 0,070$
- 7)  $c = 0,012$

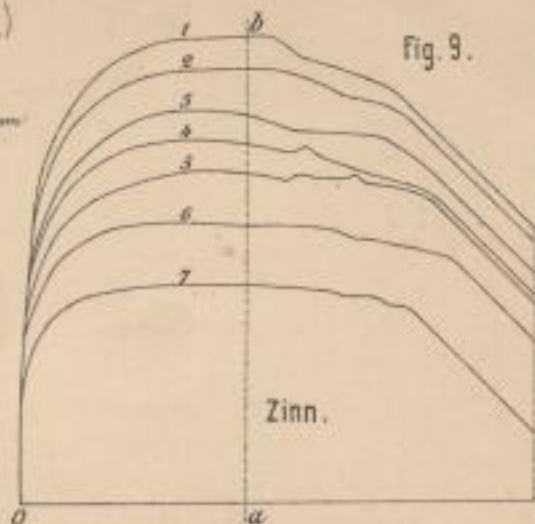

Fig. 9.

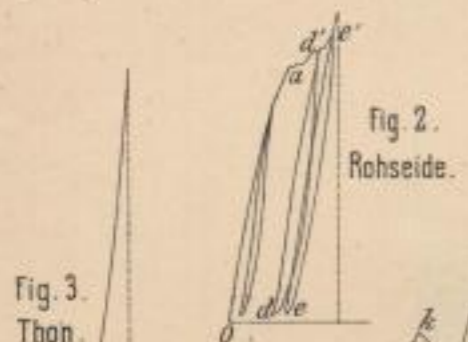

Fig. 2.  
Rohseide.

Fig. 3.  
Thon.

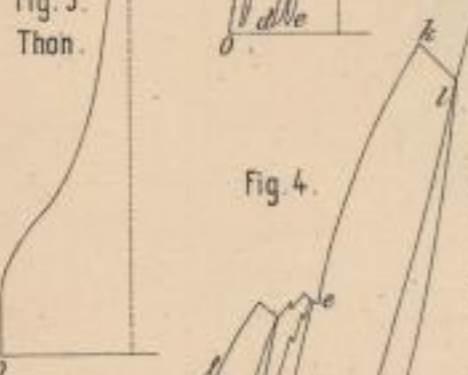

Fig. 4.

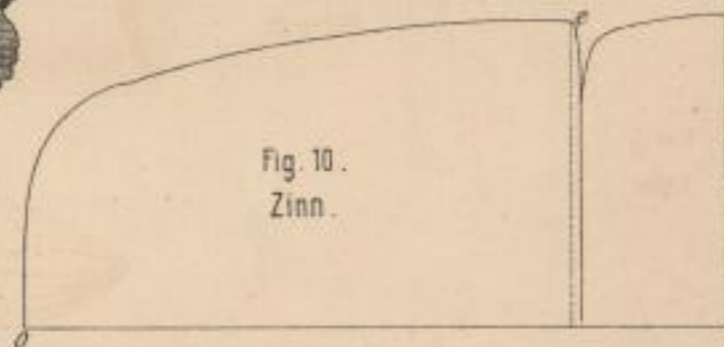

Fig. 10.  
Zinn.



Fig. 8.  
Kammwollgespinnst.



Fig. 11.



Fig. 13.  
Kammwollgespinnst.

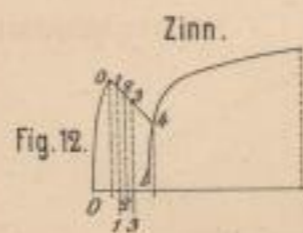
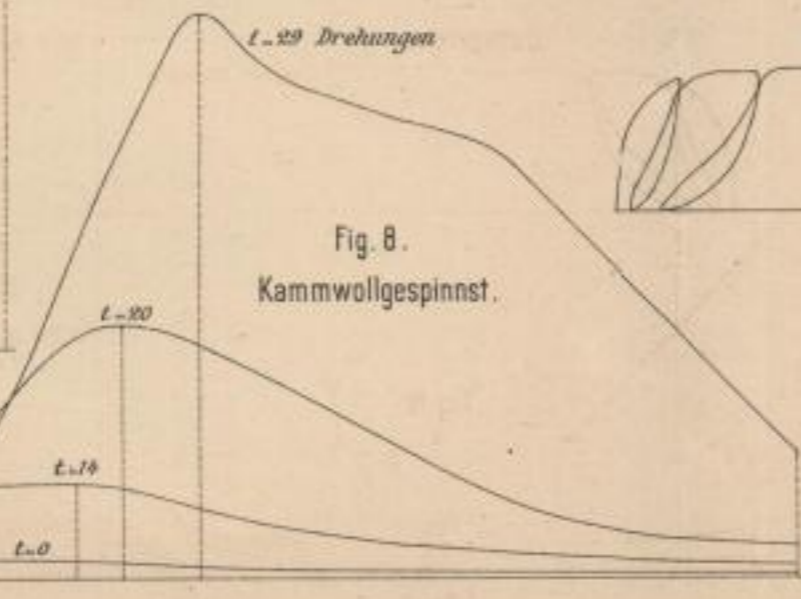

Fig. 12.

Zinn.



$t = 29$  Drehungen

Fig. 8.

Kammwollgespinnst.

Lith. Anst. v. F. Wirtz, Darmstadt.

Neuerungen an Sicherheitsschlössern. (1-15)

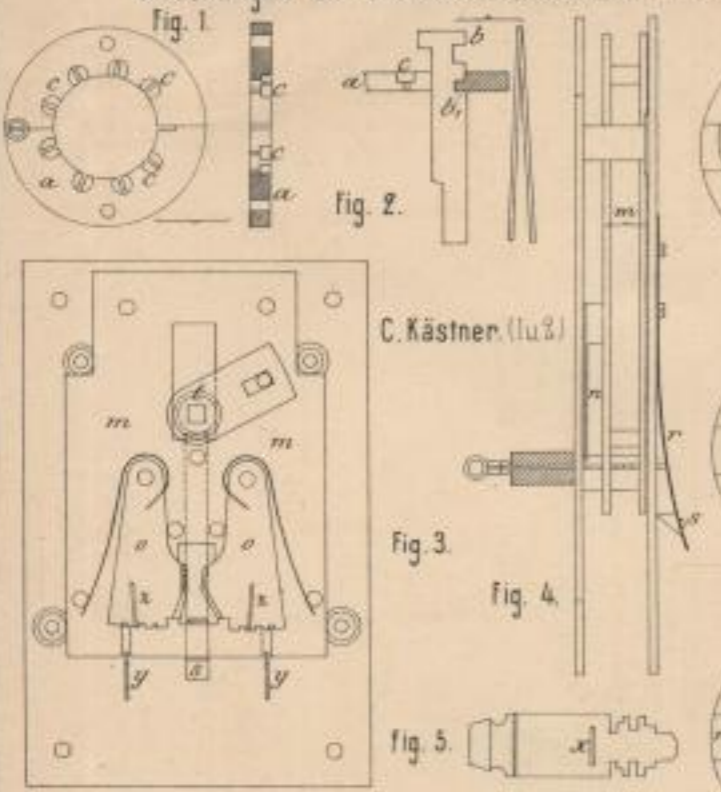

C. Kästner. (1u.3)

F. Schörg. (3-5)

Th. Kromer. (6-12)

Chr. Voss und H. C. Eggers. (13-15)

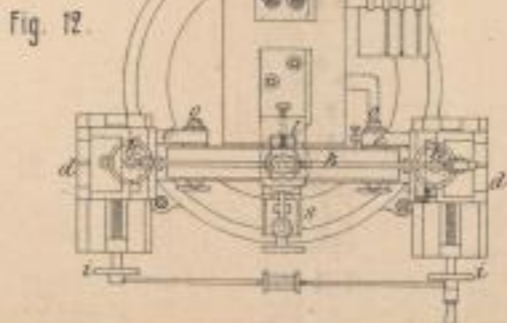
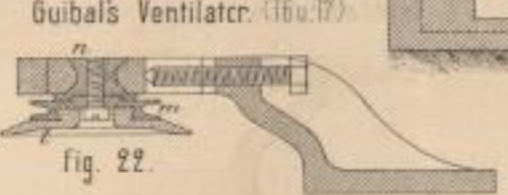
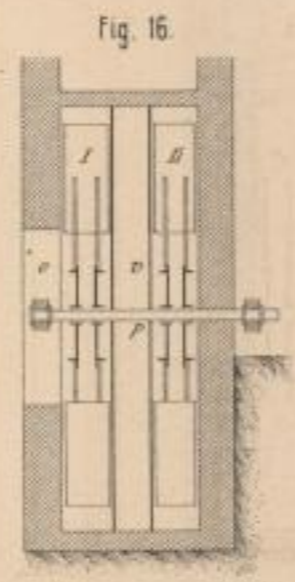
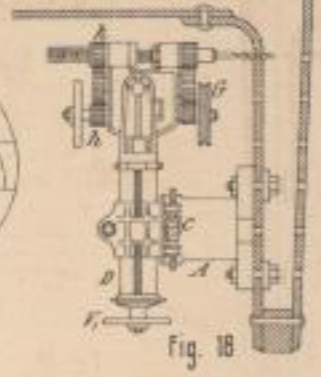
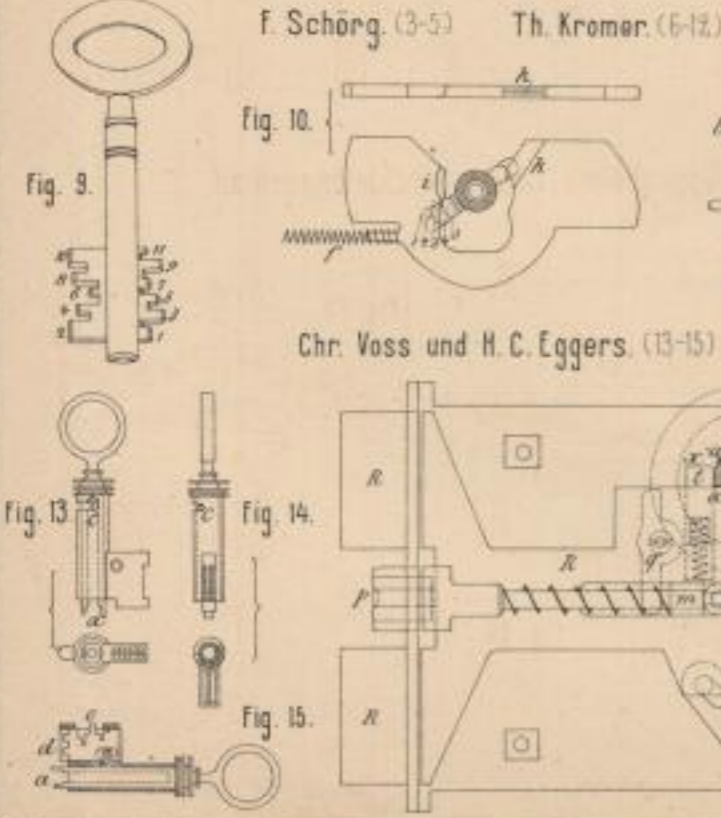

F. Mathias' transportable Bohrmaschine. (18-21)

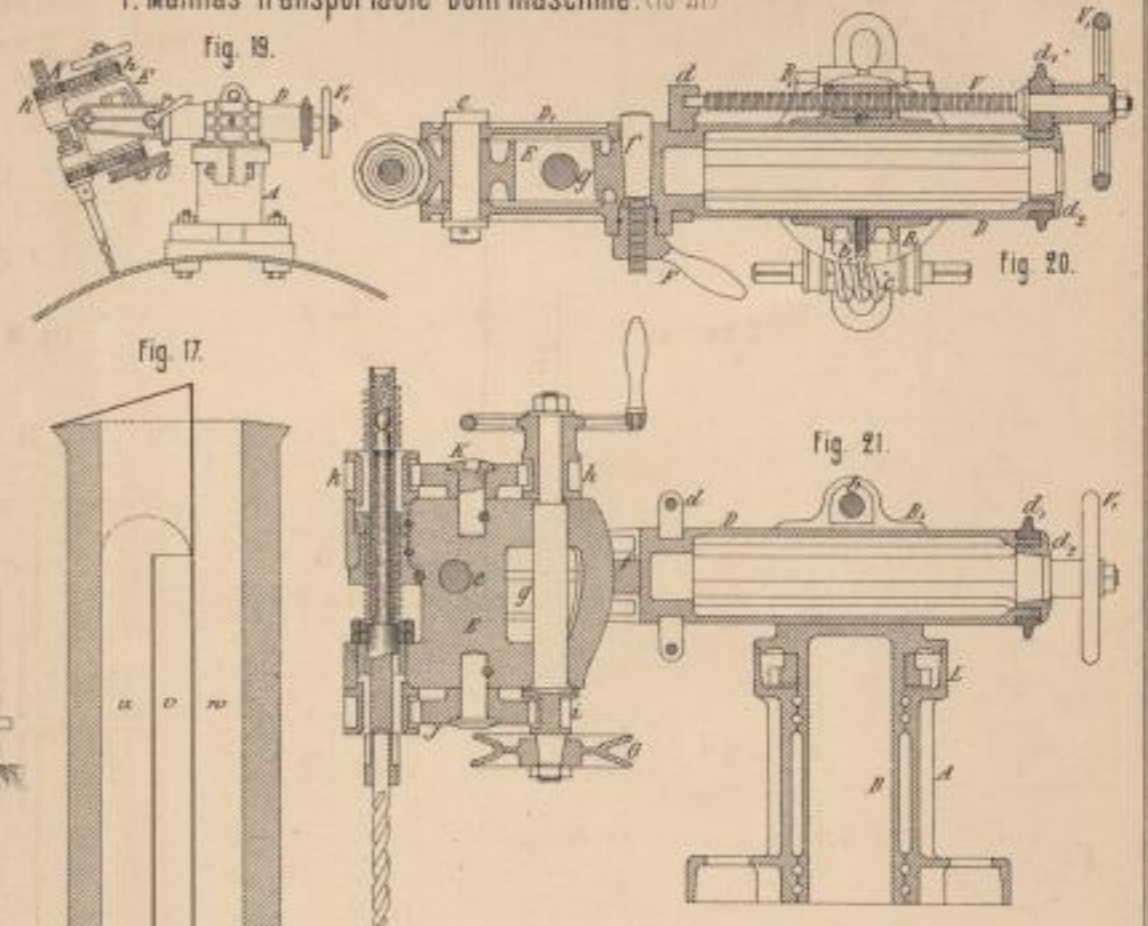

S. Oppenheim's Coulissenschleifmaschine. (22-25)

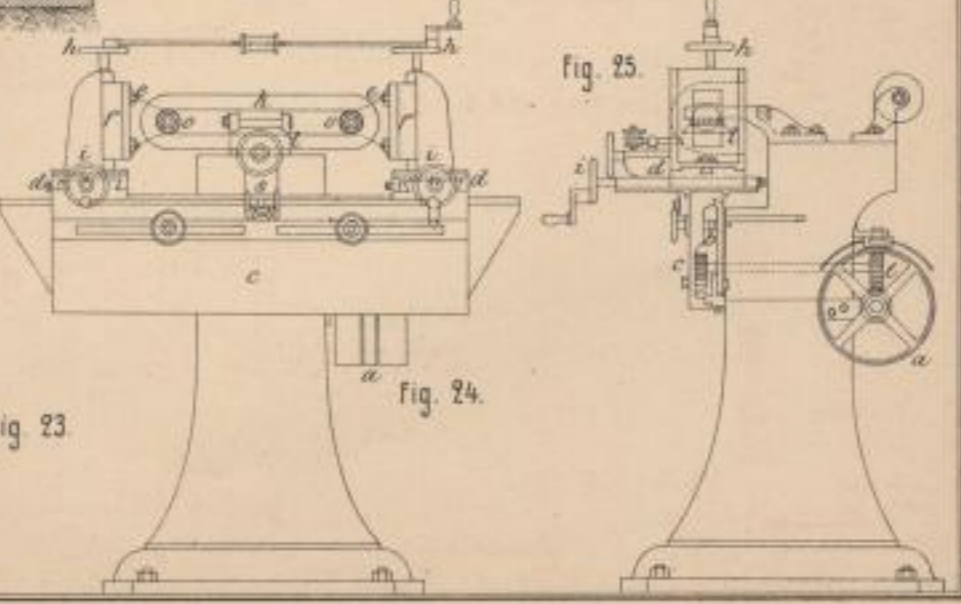

Lith. Anst. v. F. W. G. Darmstadt.

Stewart's Kupolofen. (1-5)

Apparate zur Wärmemessung. (6-12)

A. und E. Boulier. (11)

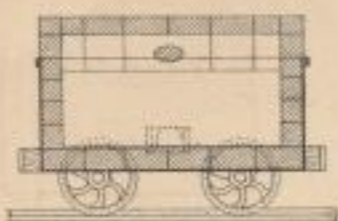

Fig. 3.

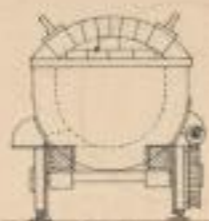

Fig. 4.

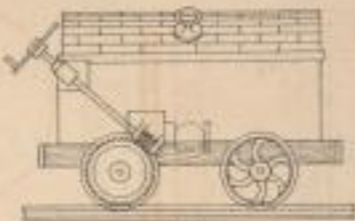

Fig. 5.

P. Suckow und Comp. (6 u. 7)

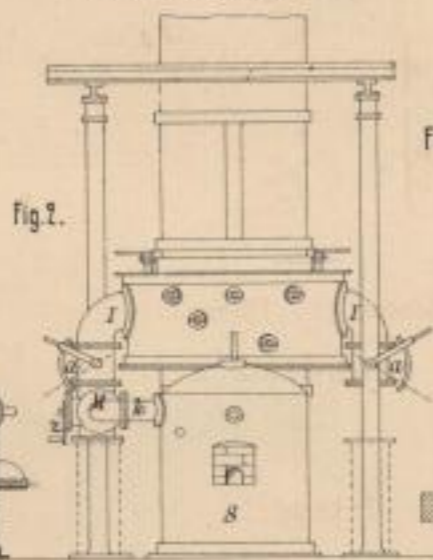

Fig. 2.

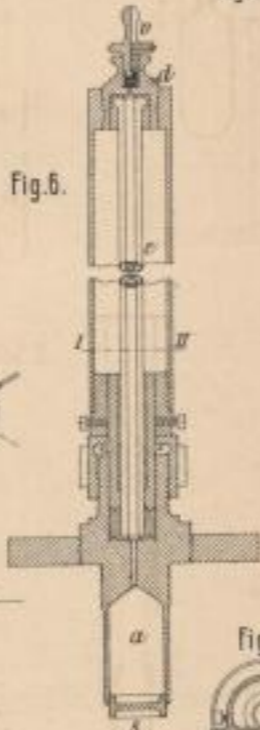

Fig. 6.

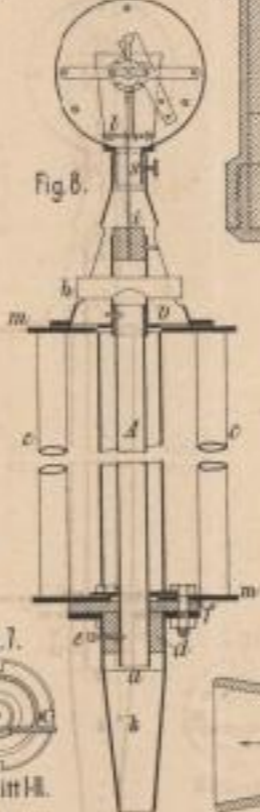

Fig. 7.

Schnitt H.

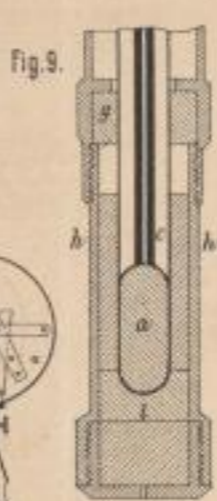

Fig. 9.

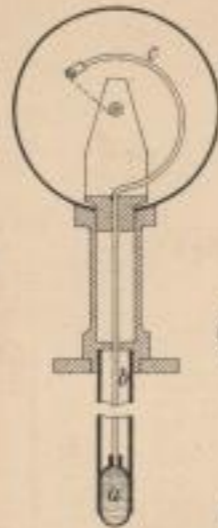

Fig. 10.

O. Schütte. (8)

F. Dehne. (9)

C. Dreyer-Bürkner. (10)

Fr. Krupp. (12)

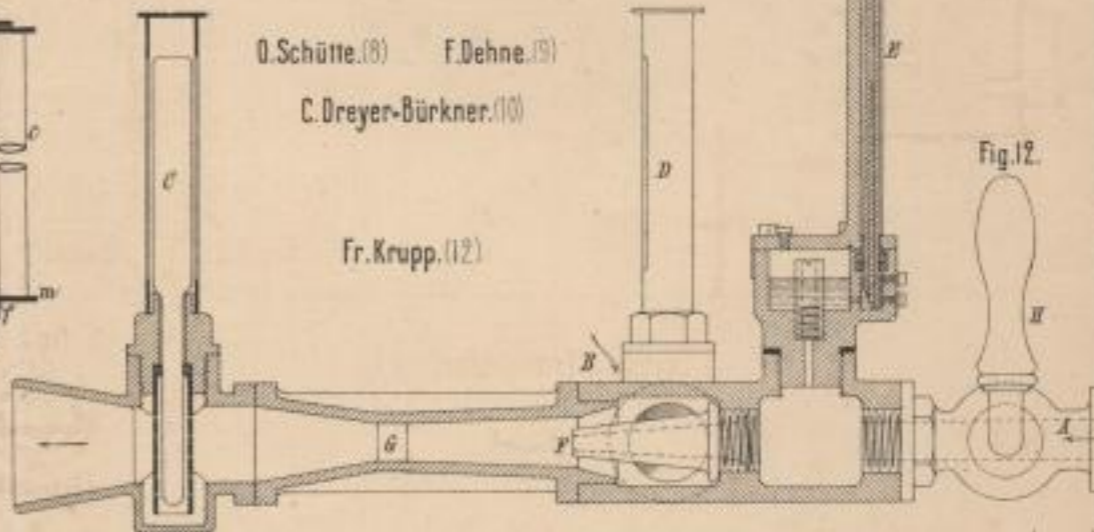

E. Leybold's Erdölprüfer. (13 u. 14)

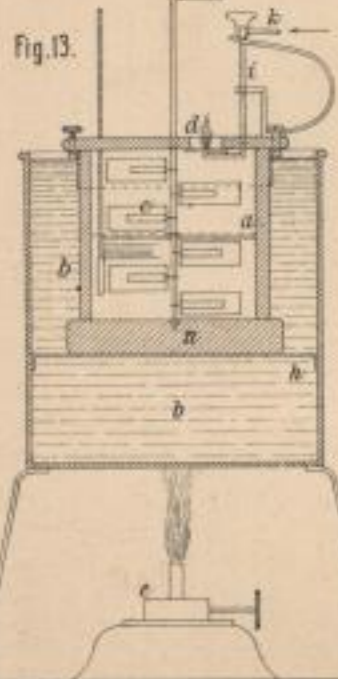

Fig. 13.

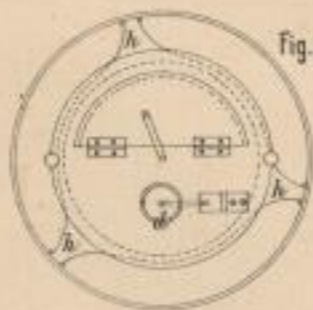

Fig. 14.

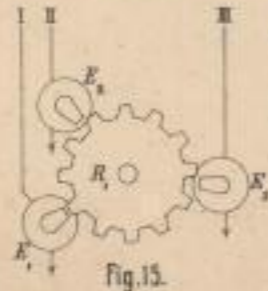

Fig. 15.

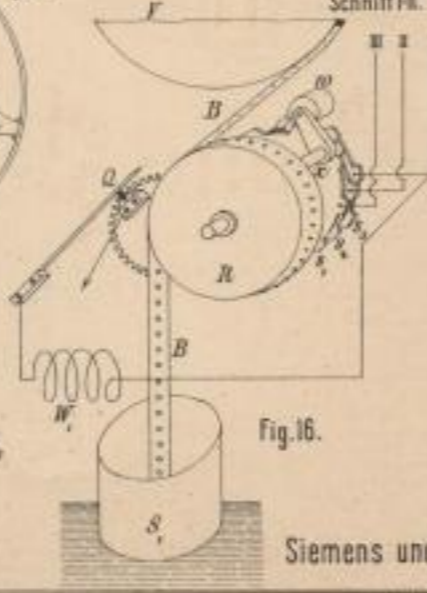

Fig. 16.

Siemens und Halske's elektrischer Fluthmesser. (15-18)

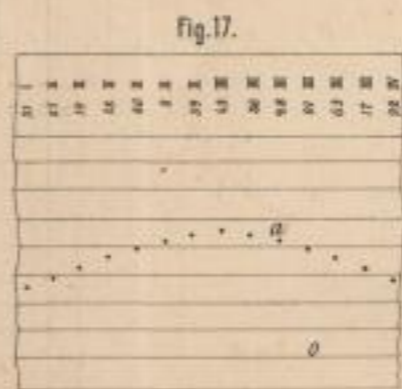

Fig. 17.

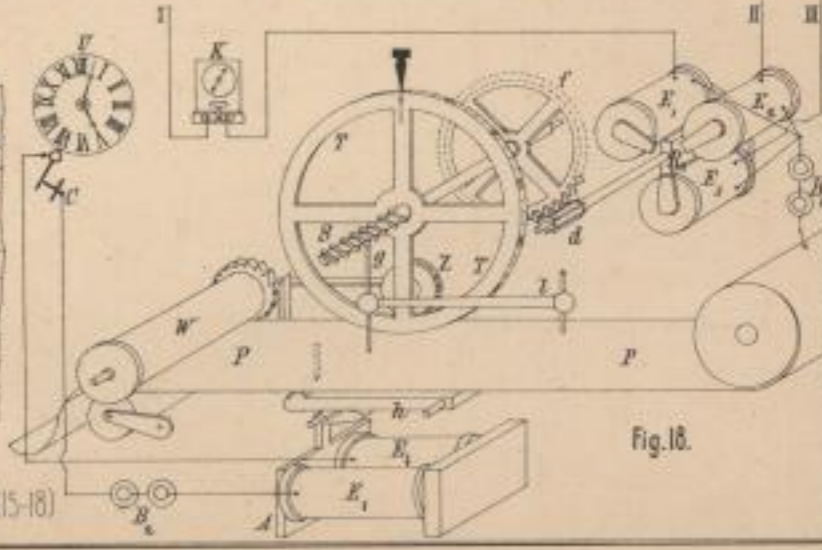
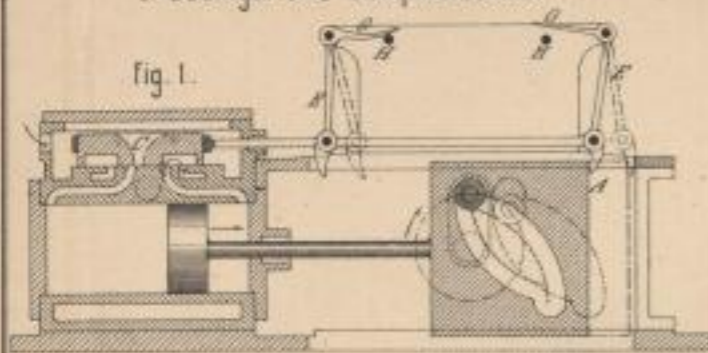

Fig. 18.

Lith. Anst. v. P. Wille, Eisenach



C. Baumgarten's Dampfmaschine. (1)



W. Hegenscheidt's Biegemaschine für Kettenglieder. (6-9)

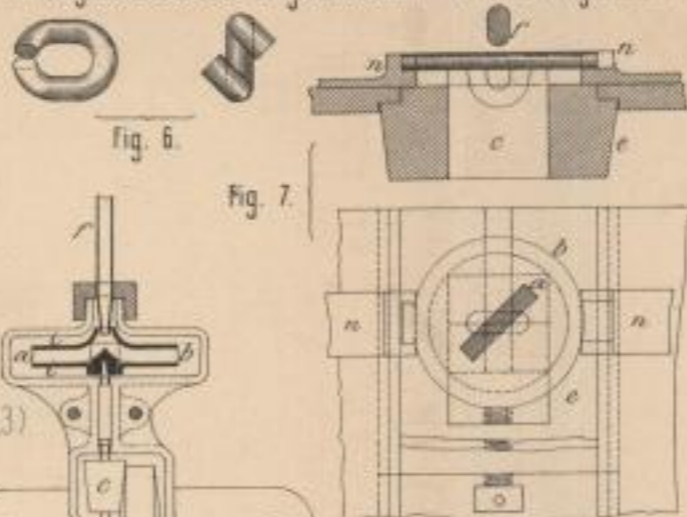

J. Stevens und Ch. Major's Aufzug. (12)

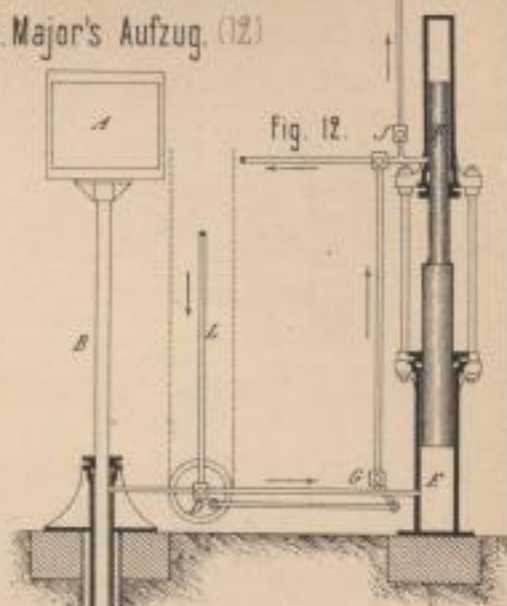

G. de Laval's Turbine für Dampf u.dgl. (2 u. 3)

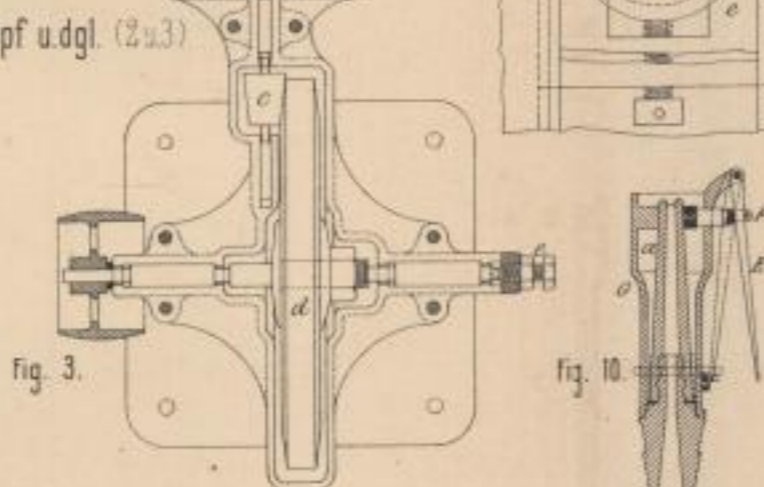
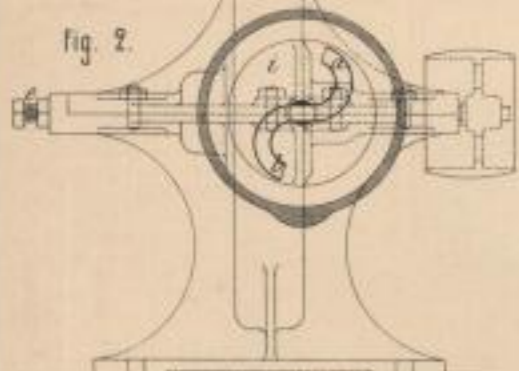

P. Schneider's rotirender Dampferzeuger. (4 u. 5) Bungarten's bez. Jansen's Strahlrohr. (10 bez. 11)

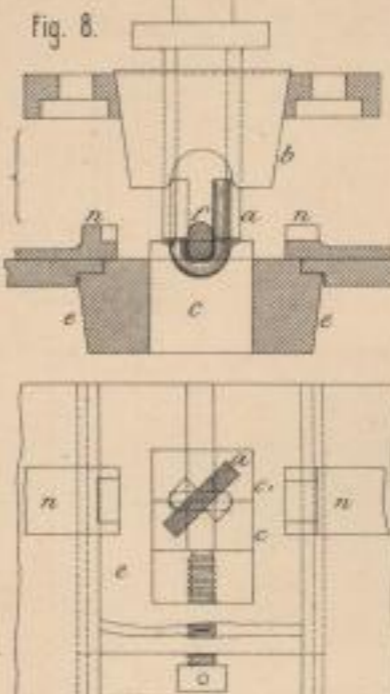
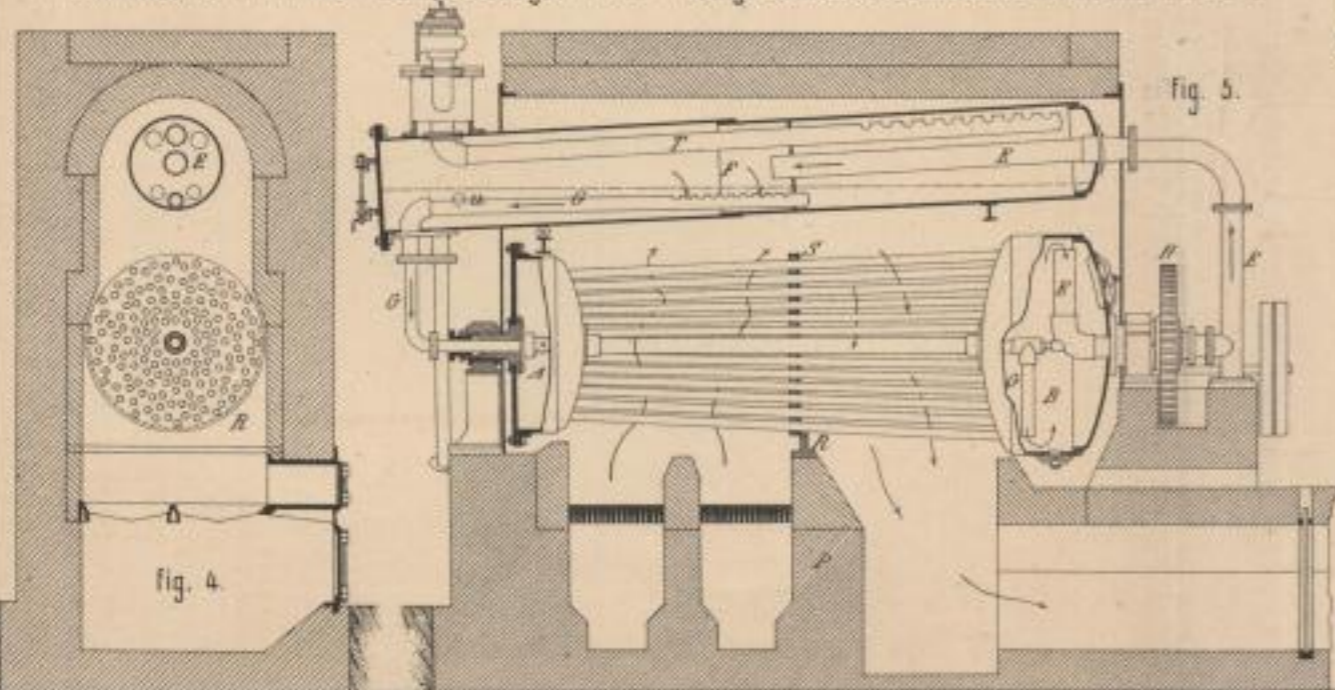

Pekrun's Anschärfapparat für Rohrenden. (13-16)

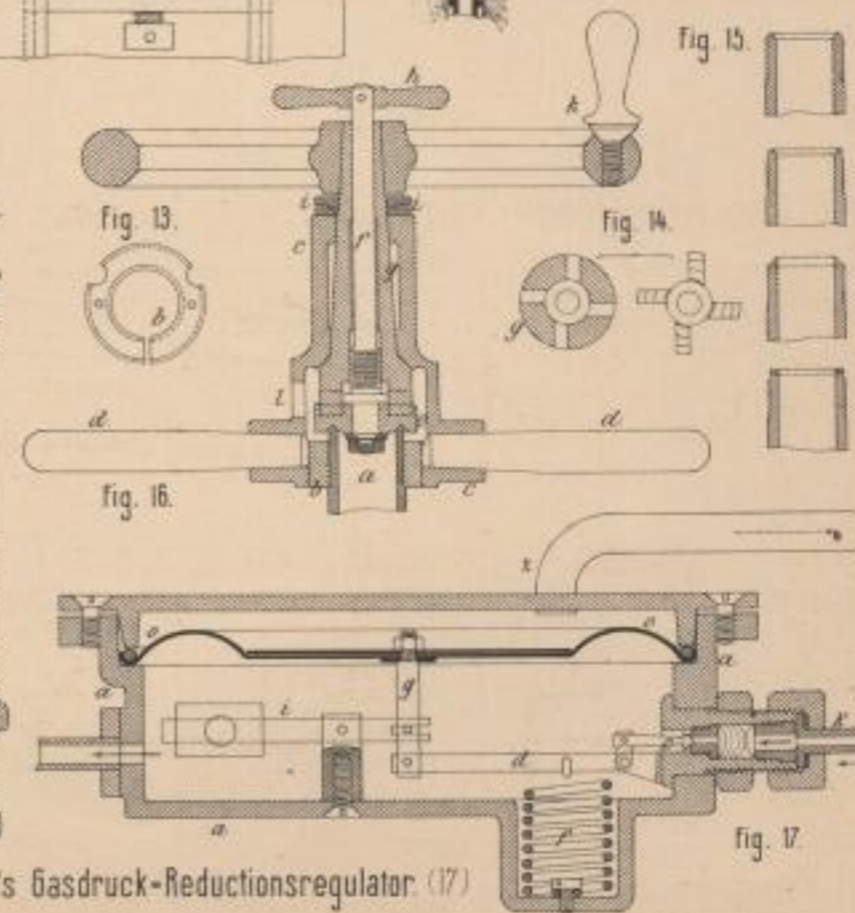

S. Elster's Gasdruck-Reduktionsregulator. (17)

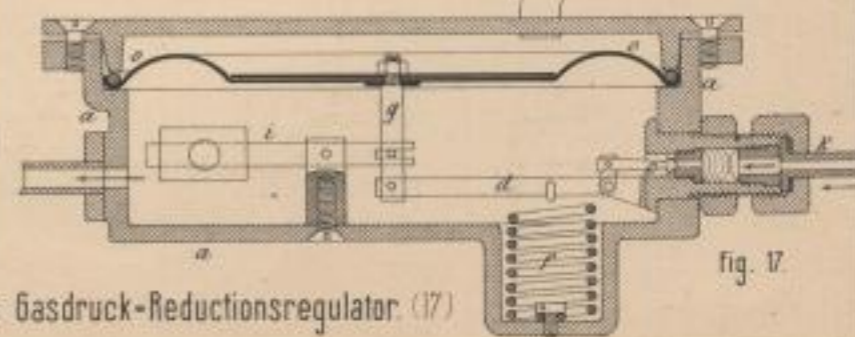

Lith. Anst. v. F. Wirtz, Darmstadt.



### Neuerungen an positiven Schützenwechslern. (1-18)

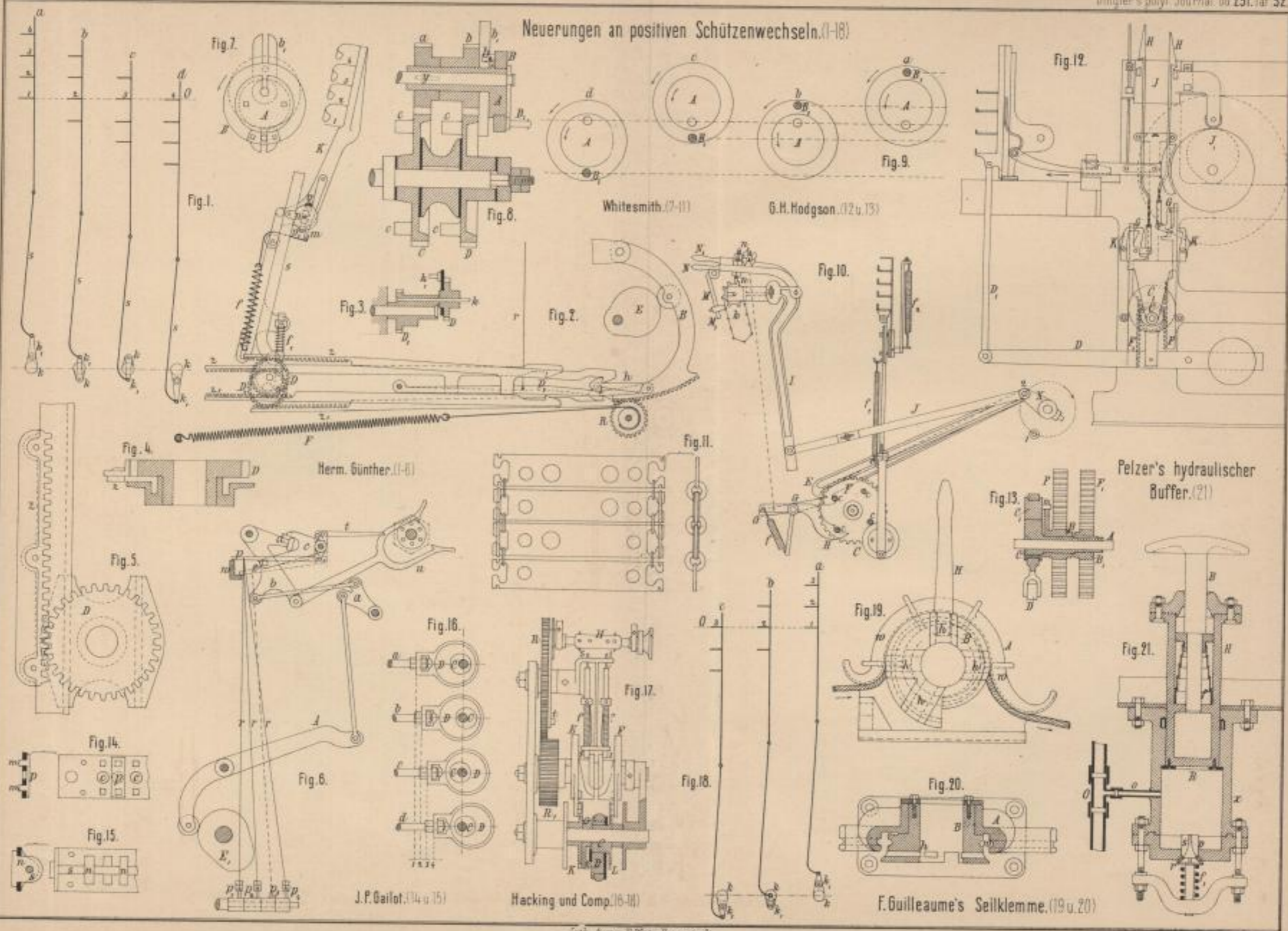

lith. Anst. v. P. W. Schmidt, Darmstadt.

W. Lönholdt. (1)

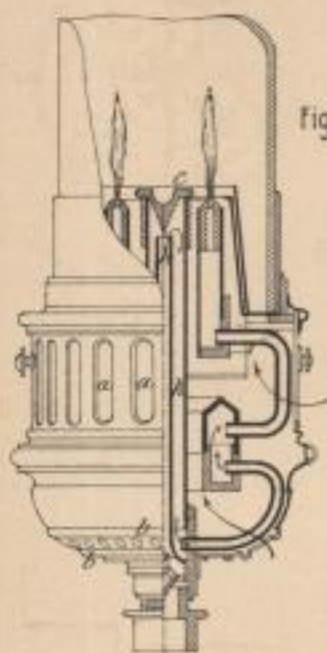

Fig. 1.

Neuere Gasbrenner mit Vorwärmung der Verbrennungsluft. (1-14)



Fig. 3.

Fig. 5.

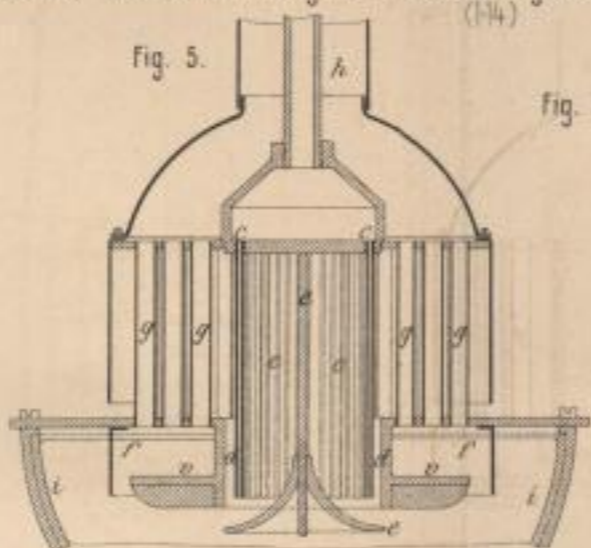

Fig. 7.

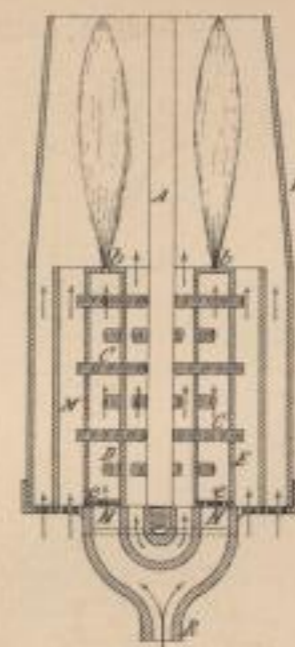
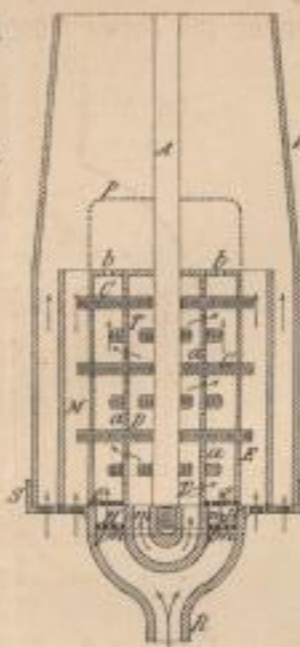

Fig. 9.



Fig. 8.

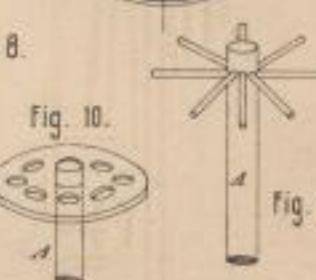

Fig. 10.

Fig. 11.

W. Grothe's Walltrockenmaschine. (15)

Fig. 15.

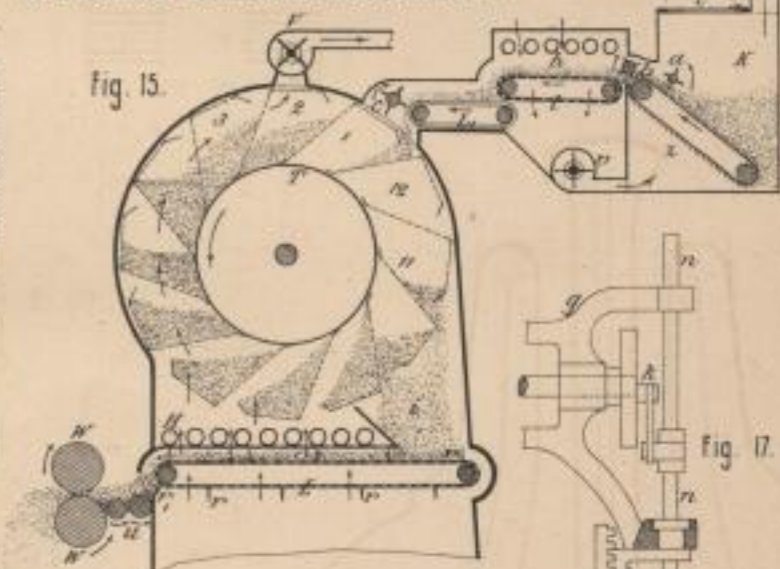
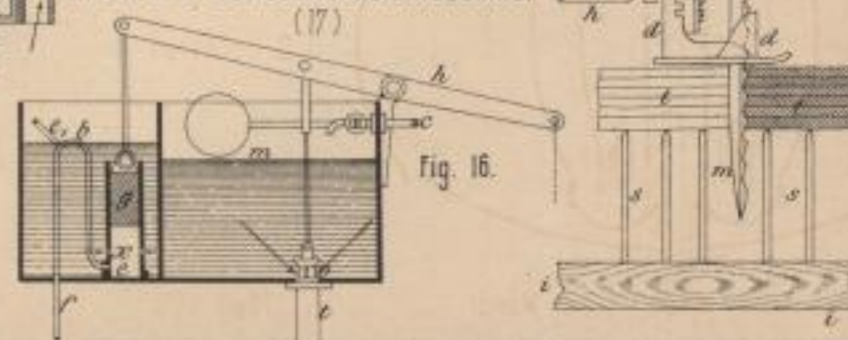

Fig. 17.

W. Fowler's Gewebeschnidmaschine. (17)

Fig. 16.



C. Clamond. (7-11, 13 u. 14)

Fig. 6.

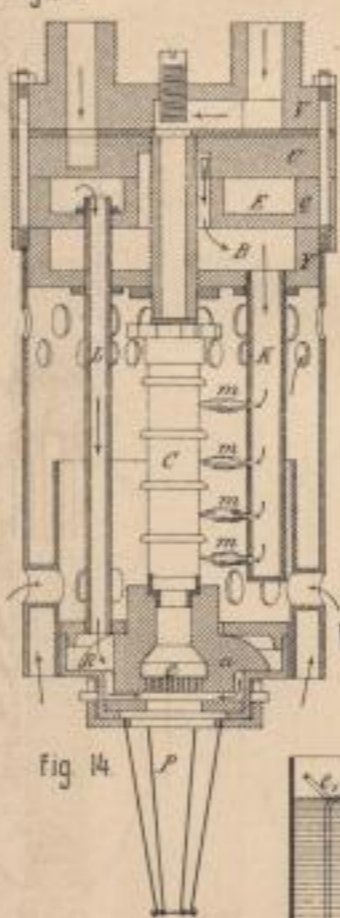
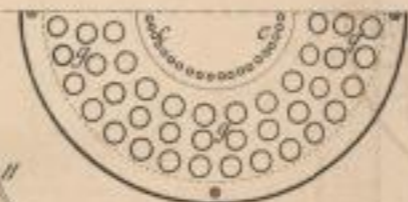

Fig. 14.

Fig. 13.



Fig. 12.



B. S. Grimston. (3-6)



Fig. 4.

Fig. 2.

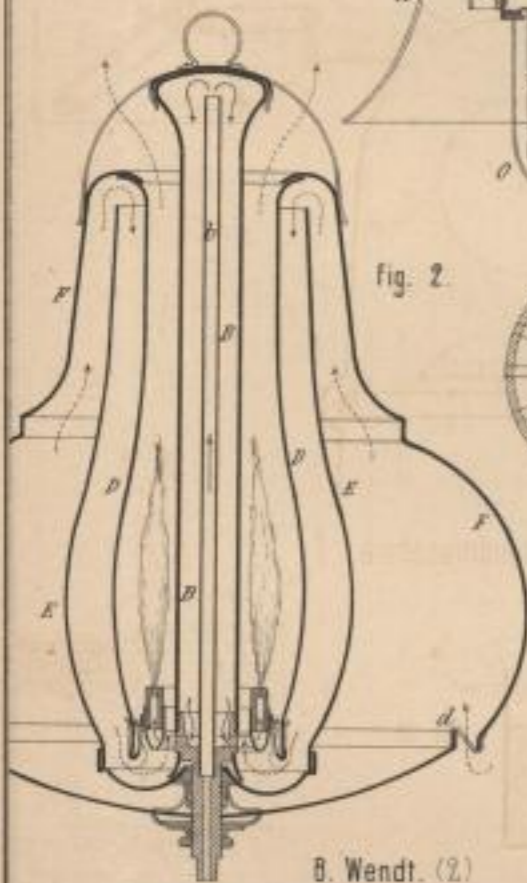

B. Wendt. (2)

Popp. (12)

G. Nobes' Desinfectionsapparat. (16)

Lith. Druck v. F. Wörke, Darmstadt.

C. Eichler. (1 u. 2)

Neuerungen an Pumpen. (Taf. 34 u. 37)

Schütz und Hertel. (16 u. 17)

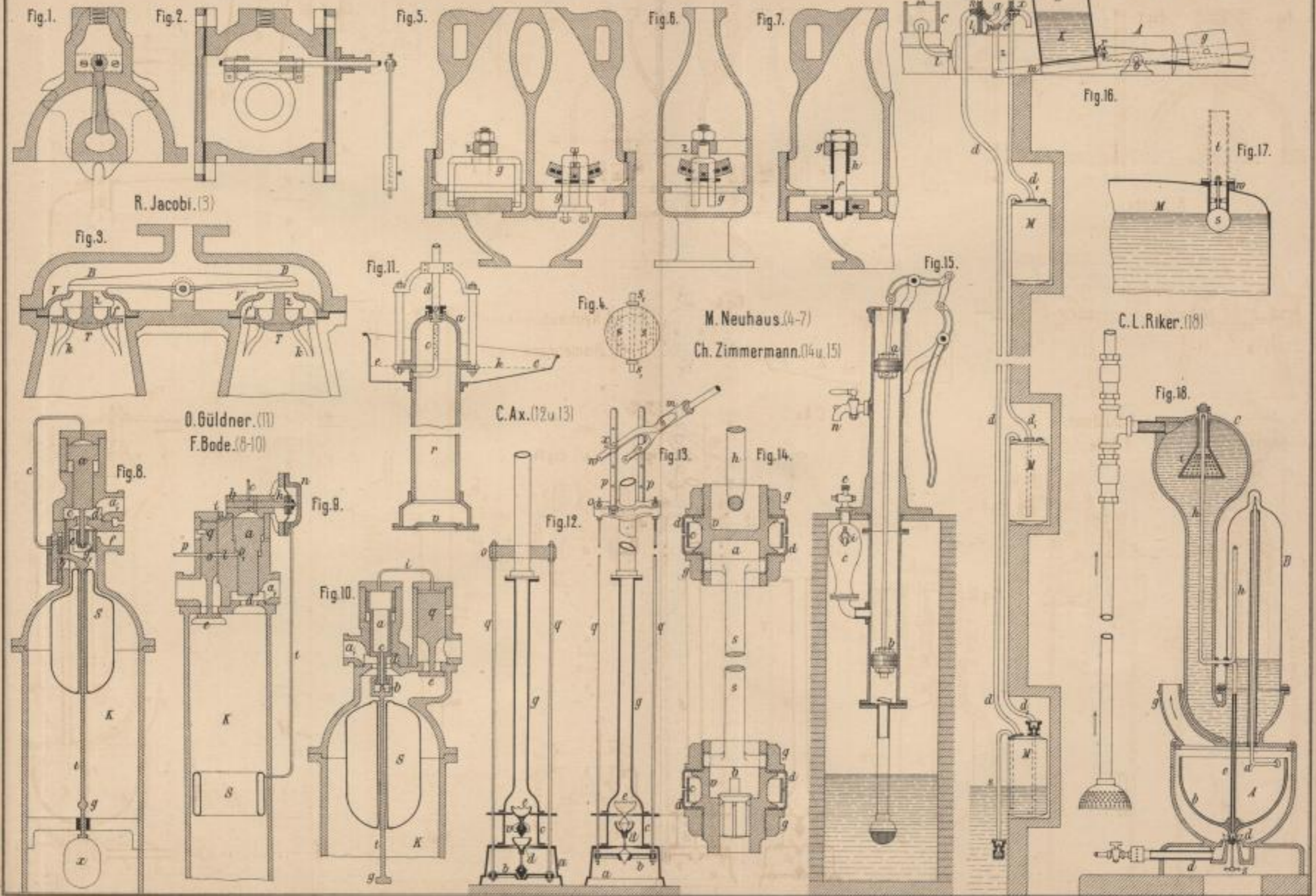

R. Jacobi. (3)

O. Güldner. (11)

F. Bode. (8-10)

C. Ax. (12 u. 13)

M. Neuhaus. (4-7)

Ch. Zimmermann. (14 u. 15)

C. L. Riker. (18)

Lith. Anst. v. P. Wren. Darmstadt.



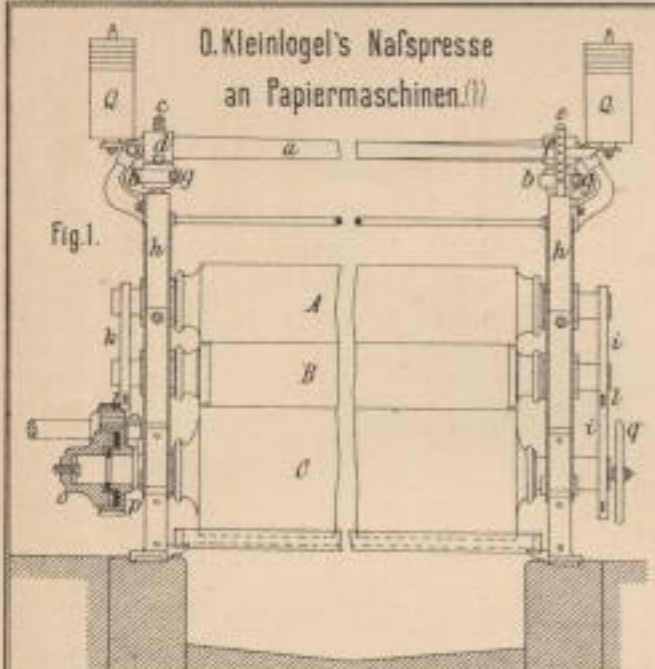

D. Kleinlogel's Nafspresse an Papiermaschinen. (1)

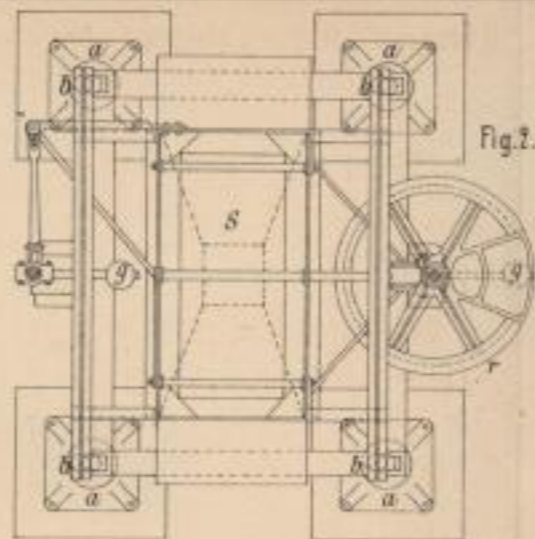
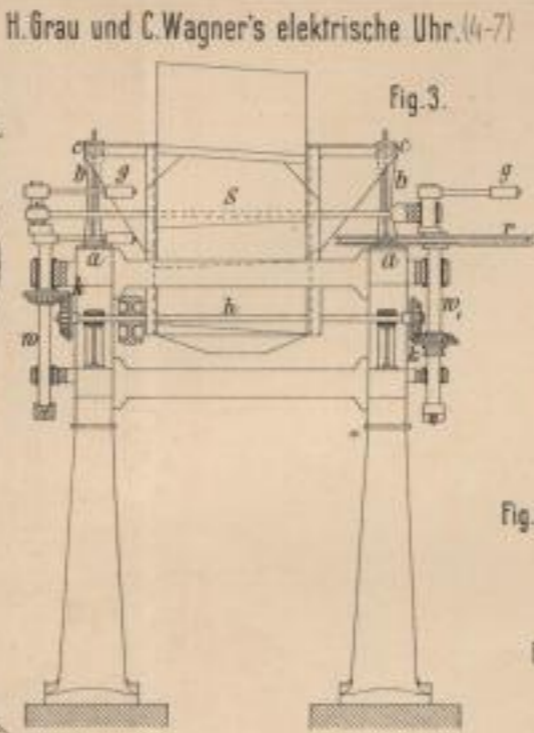

Fig. 2.



H. Grau und C. Wagner's elektrische Uhr. (4-7)

Fig. 3.

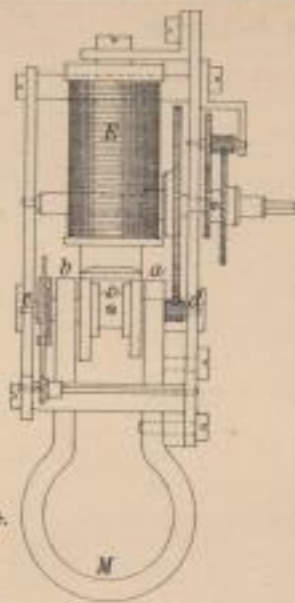

Fig. 4.

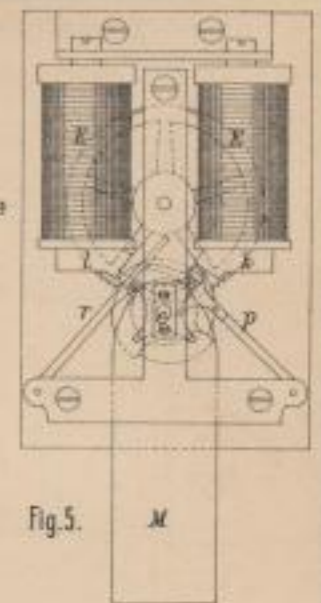
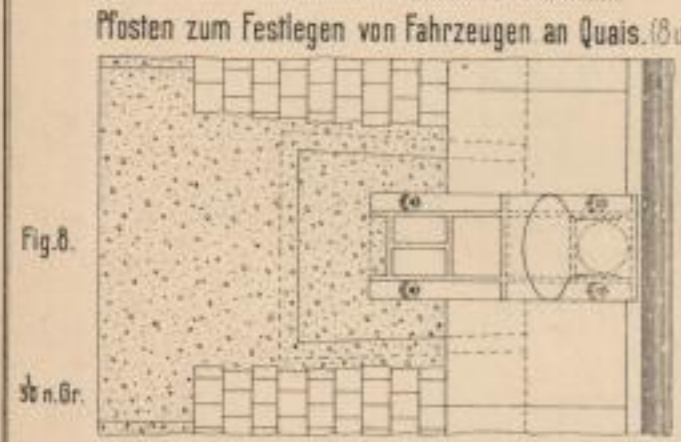

Fig. 5.



Pfosten zum Festlegen von Fahrzeugen an Quais. (8 u 9)

Fig. 8.

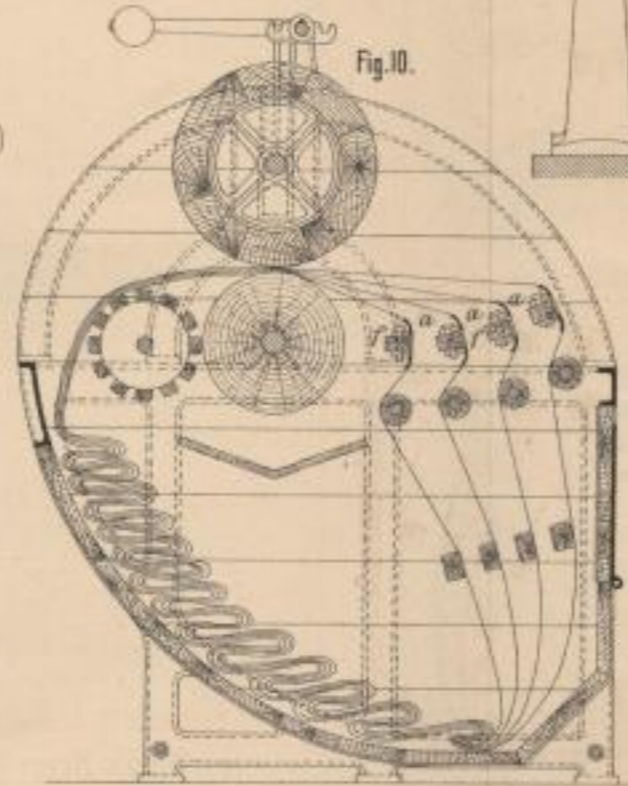

Fig. 10.

F. W. Klönne's Kreiselrätter. (2 u 3)



Fig. 11.

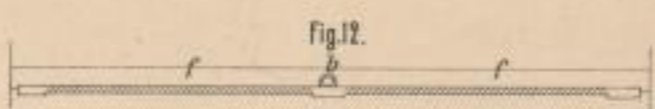

Fig. 12.

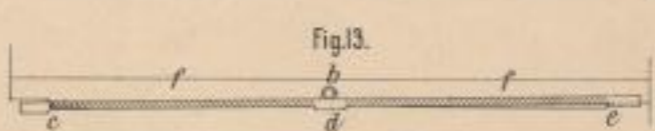

Fig. 13.

F. Bernhardt's Breitwaschmaschine. (10-13)

Th. H. Ward's Waage für Eisenbahnfahrzeuge. (14-17)

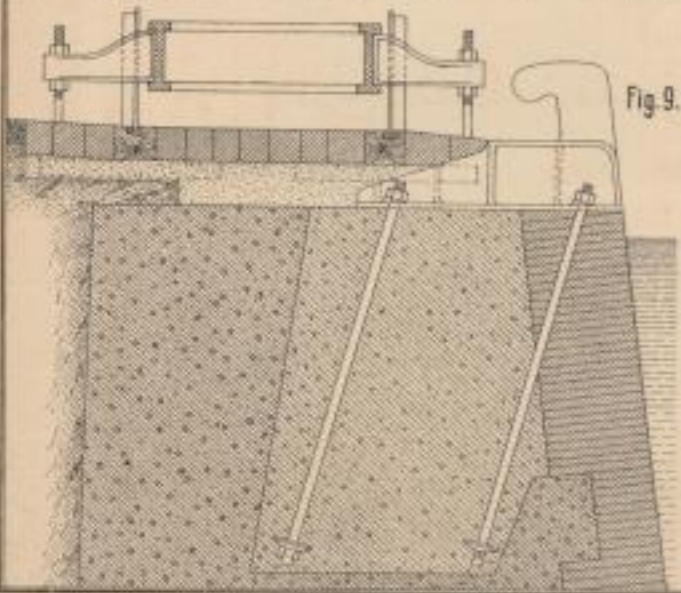

Fig. 9.

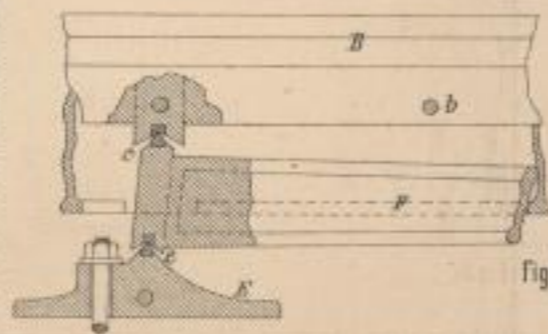

Fig. 14.

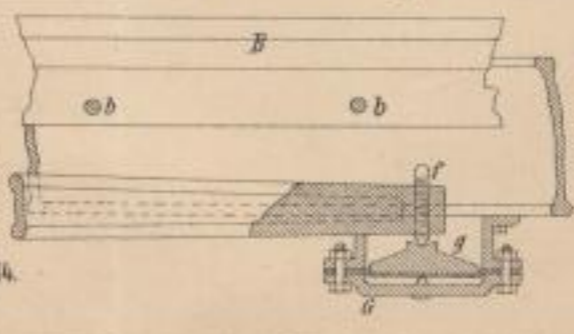

Fig. 15.

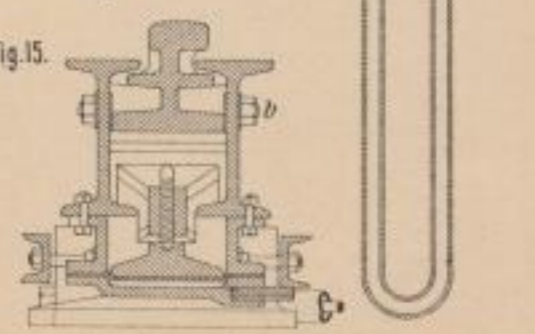
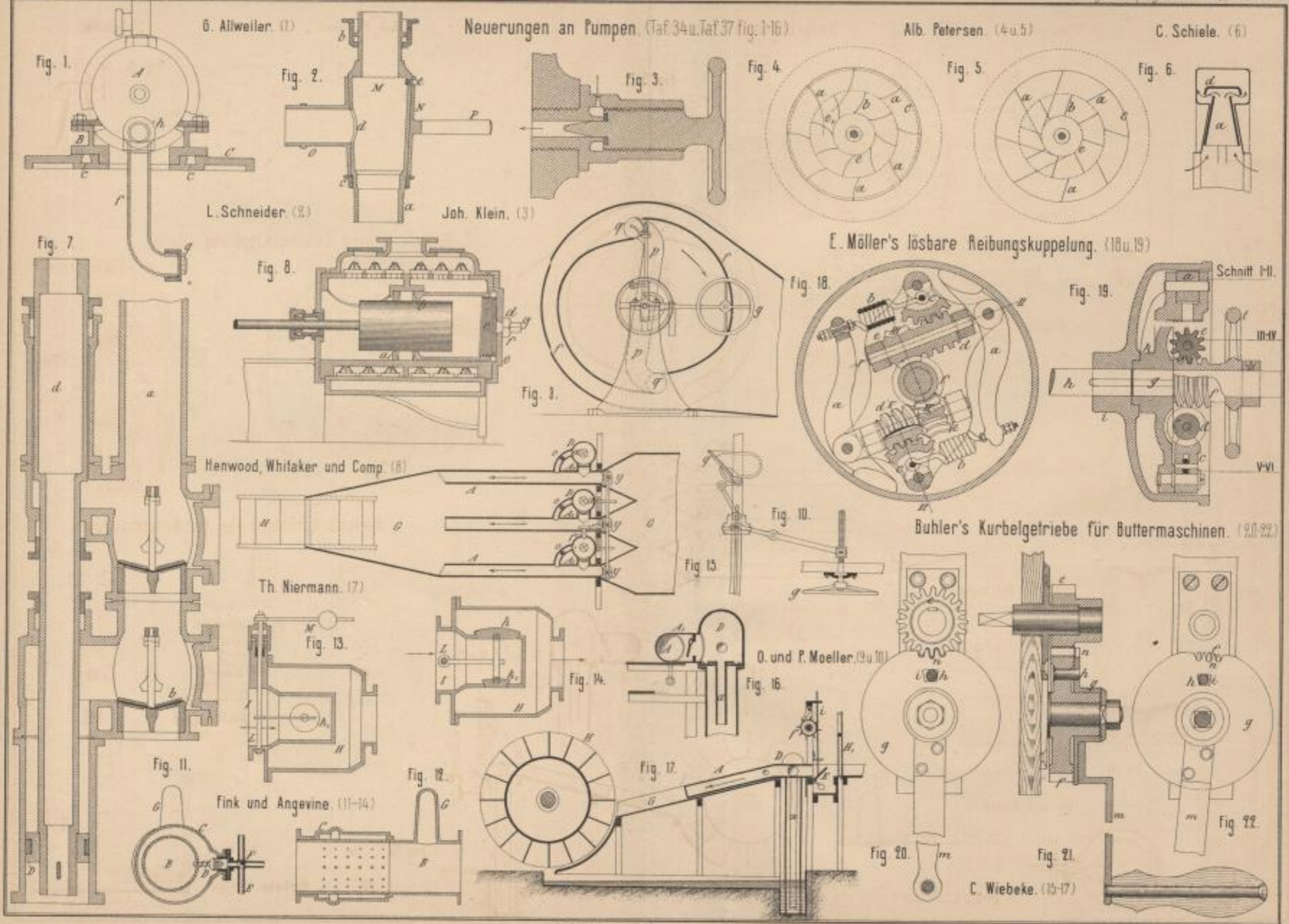

Fig. 16.

Fig. 17.

lith. Anst. v. F. Wirtz, Darmstadt



lith. Anst. v. F. Wirtz, Darmstadt.

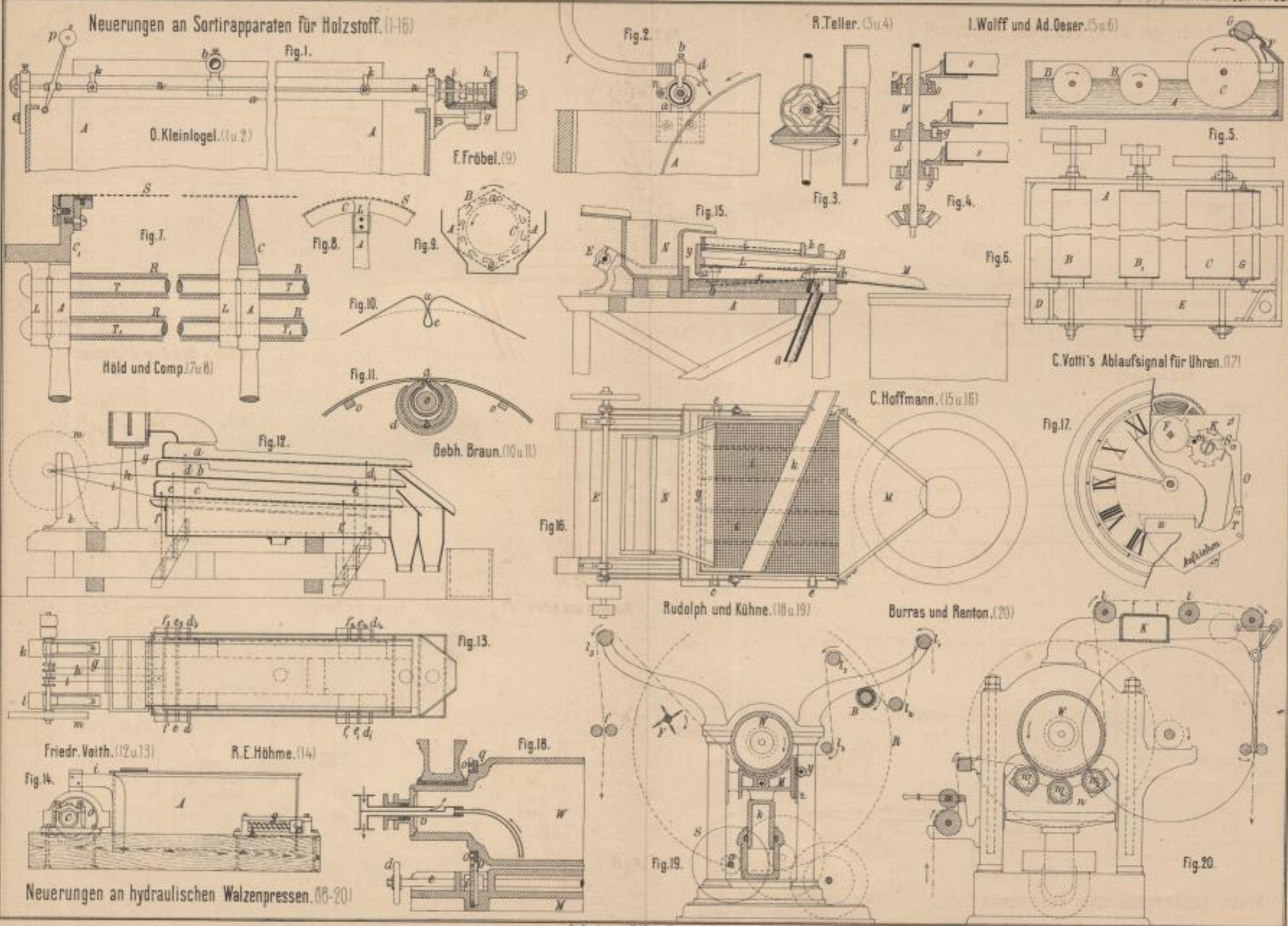

Lith. Anst. v. P. Wirtz, Darmstadt.

H. Arlow's Anlage zur Herstellung von Zündhölzern. (1-7)

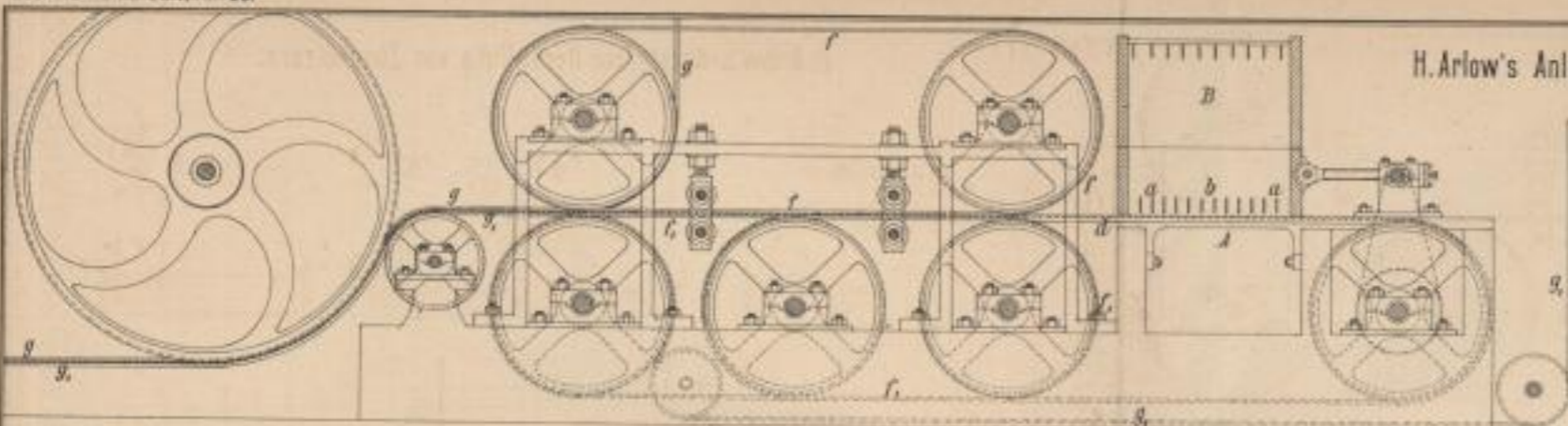

Fig. 1.

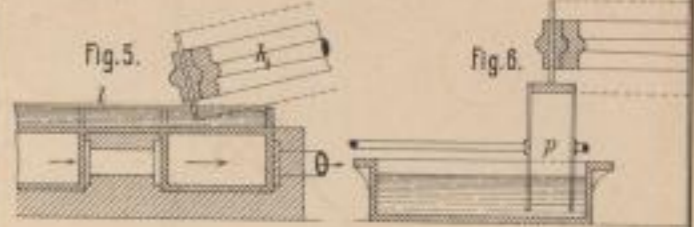

Fig. 5.

Fig. 6.

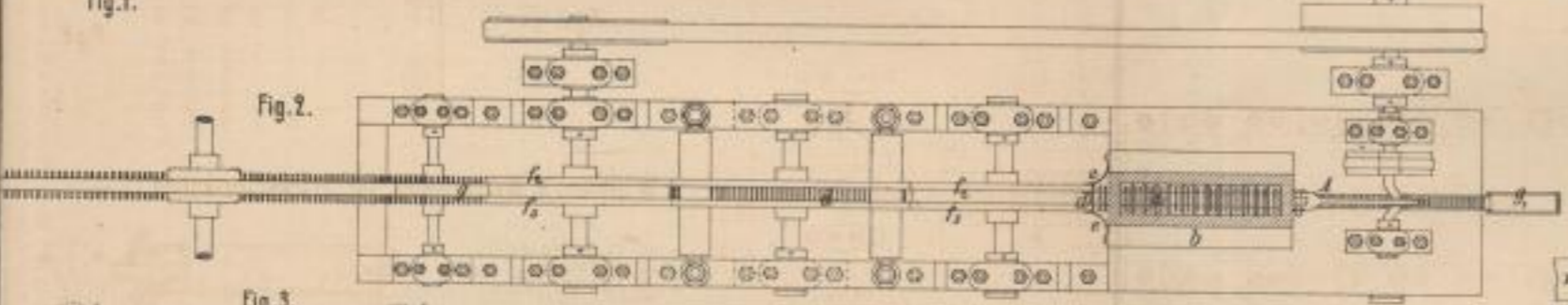

Fig. 2.

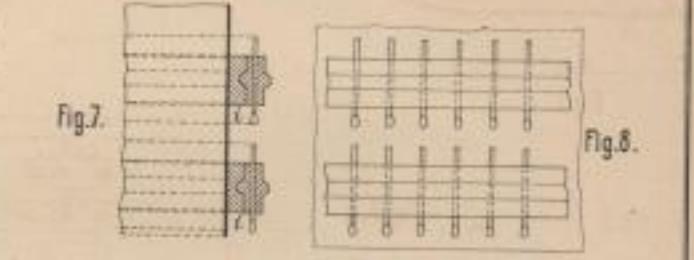

Fig. 7.

Fig. 8.

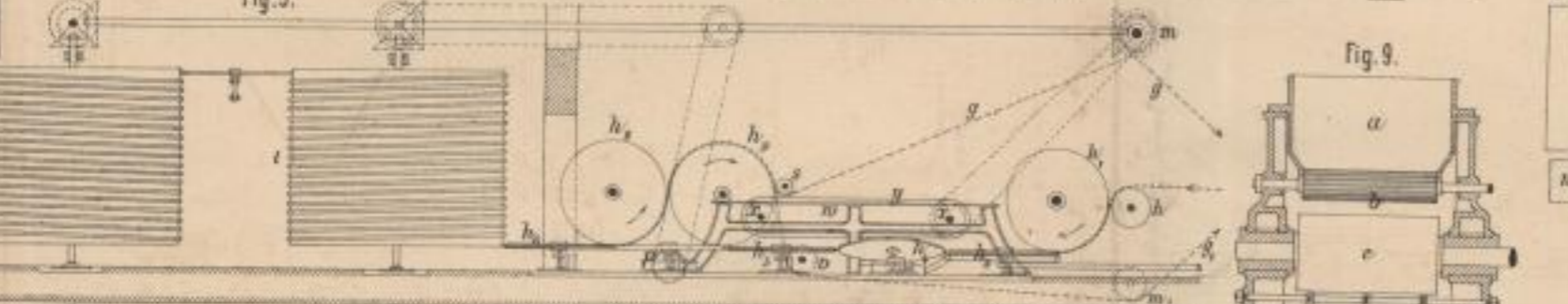

Fig. 3.

W. Uhland's Walzenstuhl für Stärkefabrikation. (9-12)

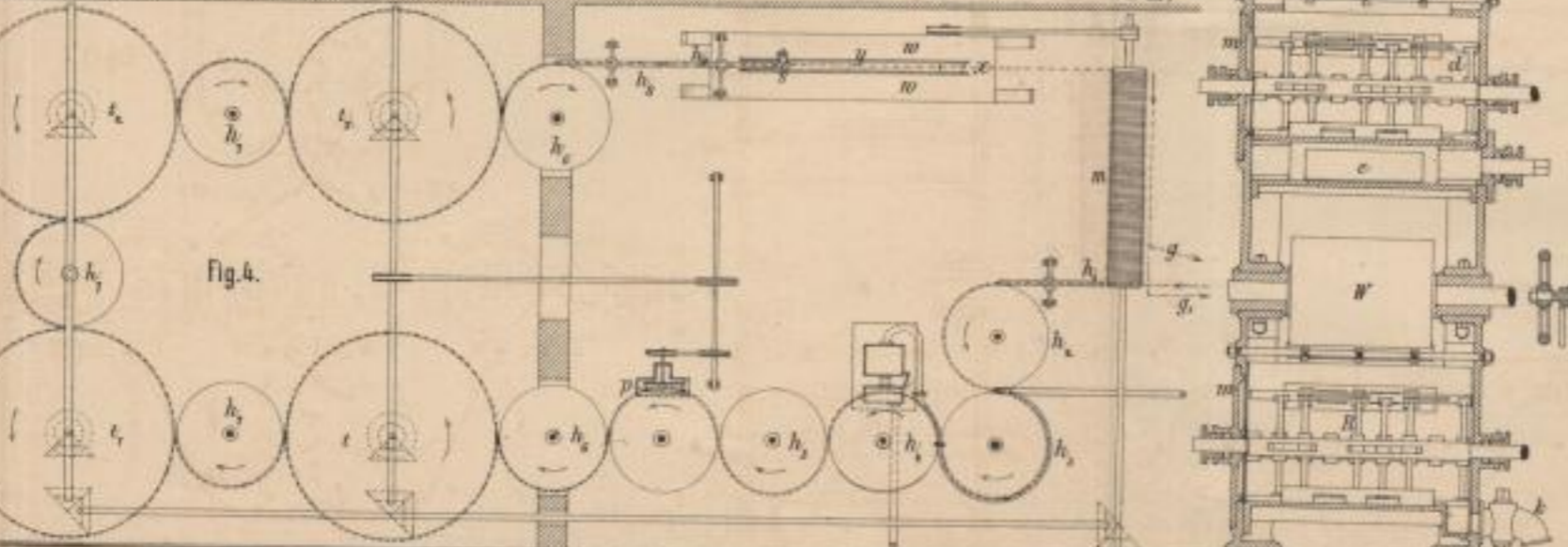

Fig. 4.

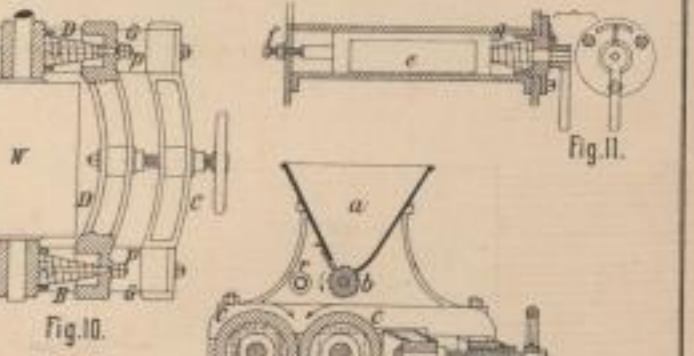

Fig. 9.

Fig. 10.

Fig. 11.

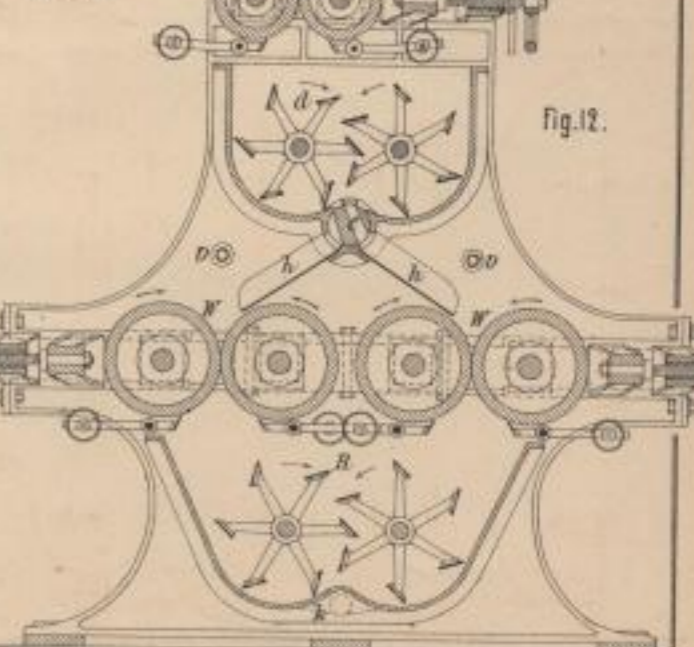

Fig. 12.

Leib. Arch. v. F. Wern. Darmstadt







1770



Matzelmaier  
Buchbinder  
1872 1898

X

Technol. A. 264

SLUB DRESDEN



3 2422828