

Atlas

zu

Dingler's polytechnischem Journal.

Band 249.

(Vierundsechzigster Jahrgang.)

Jahrgang 1883.

Enthaltend 35 lithographirte Tafeln.



Stuttgart.

Verlag der J. G. COTTA'schen Buchhandlung.

04538

Atlas

Journal der Naturforschenden Gesellschaft in Leipzig

Band 213

(Wissenschaftsberichte Leipzig)

Leipzig 1928

Erhalten 20. November 1928



Erhalten 20. November 1928

Sächs.
Landes-
Bibl

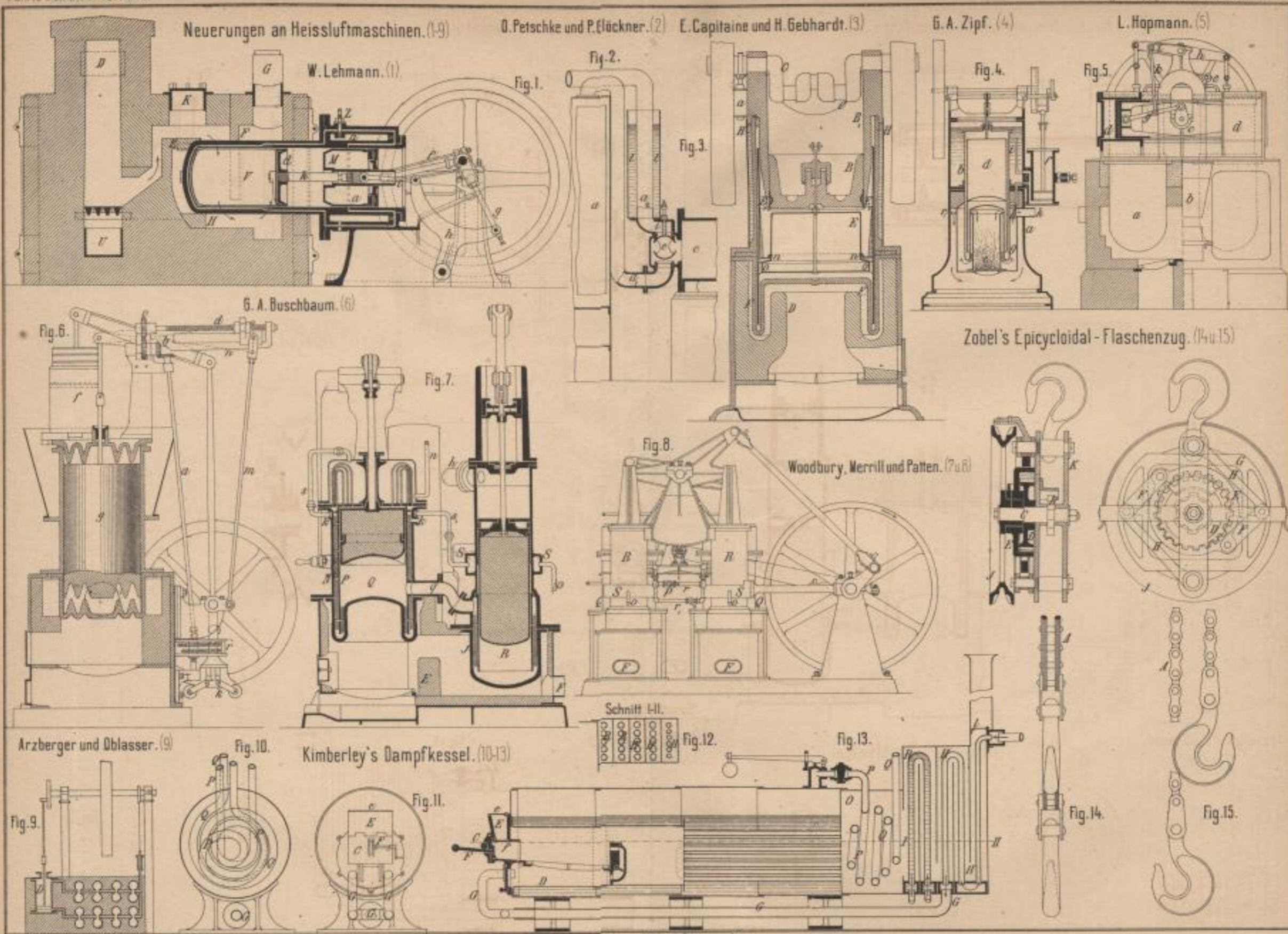

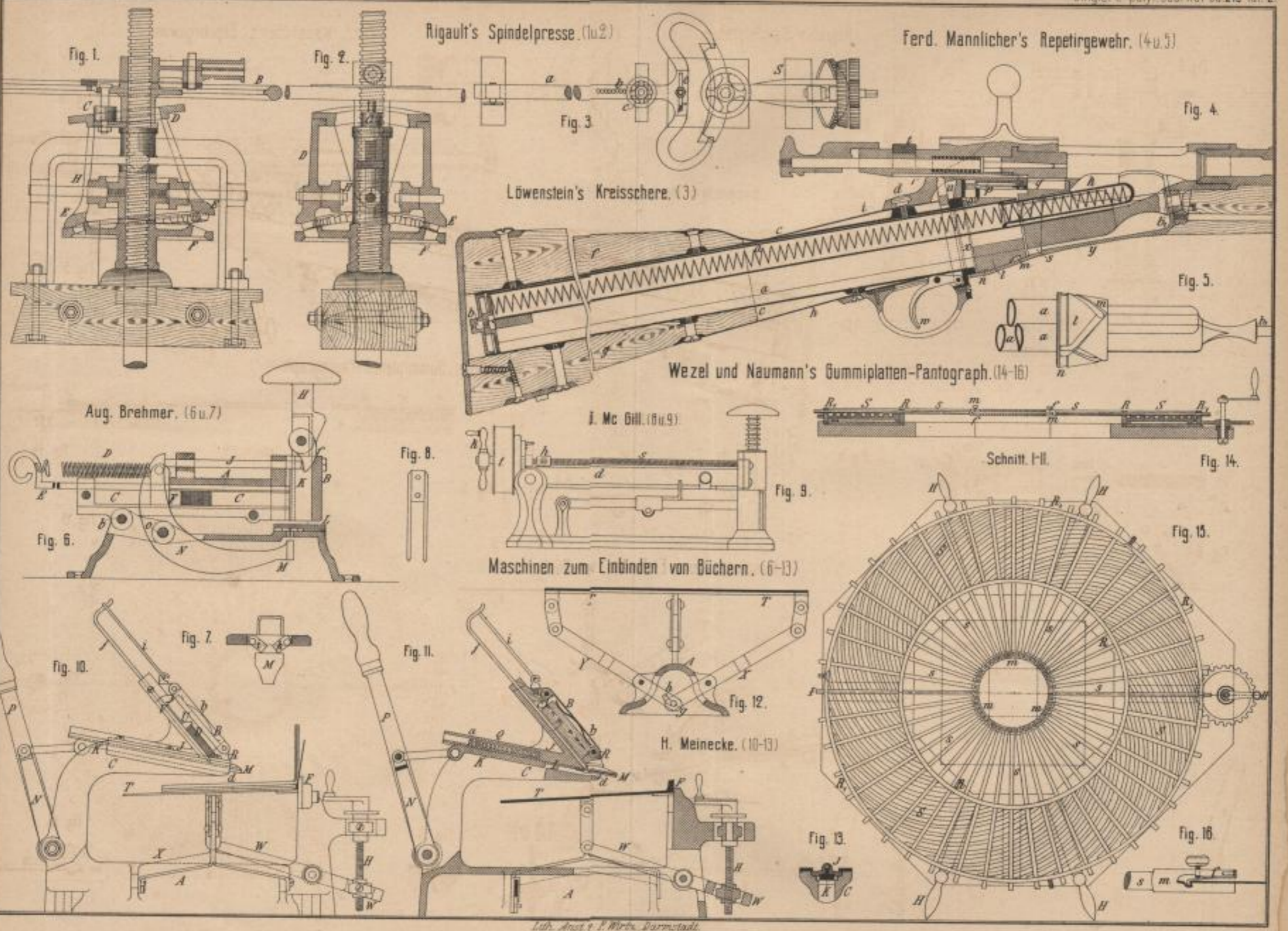

Reinecken und Poensgen's Zinn- gewinnung aus Abfällen. (Tu. 2.)

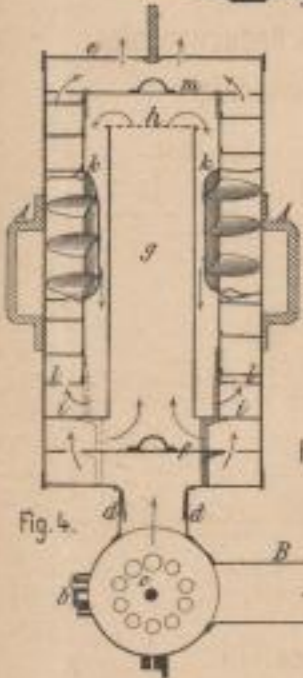
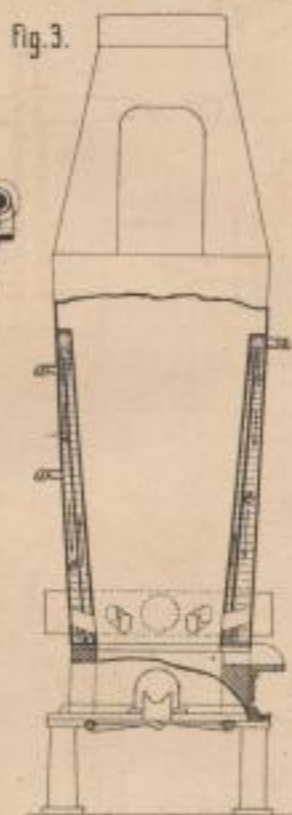
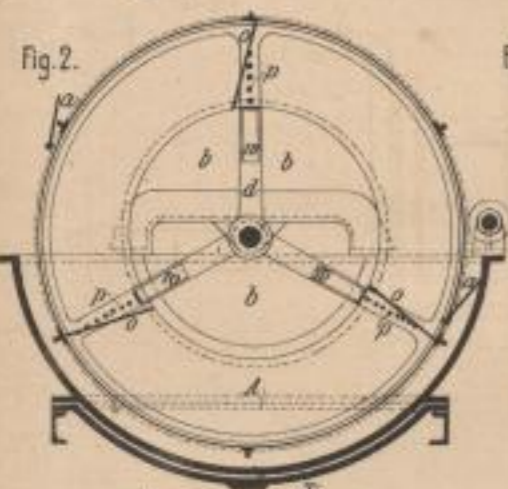
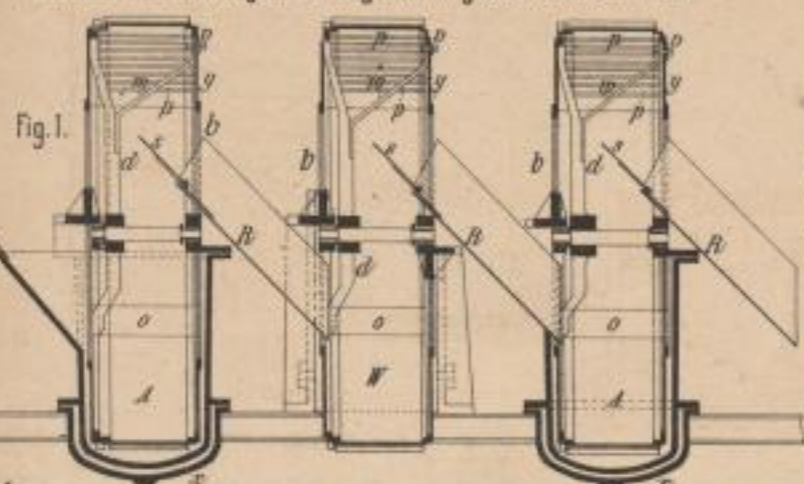

Rankin und Brayton's Kupferschmelzofen. (9)

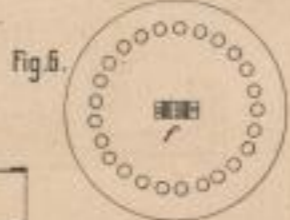

Mielchen's Zinkballon. (4-6)

Eichhorn und Liebig's Röstofen für Zinkblende. (7u. 8)

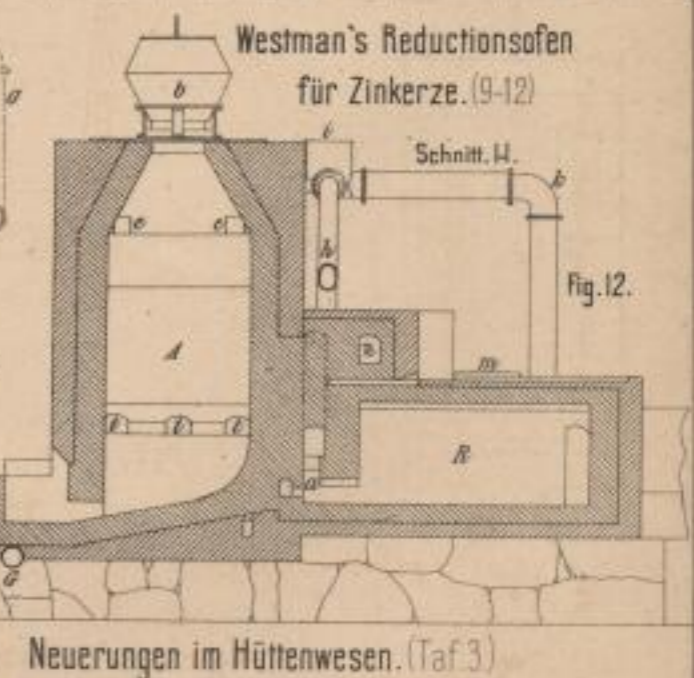
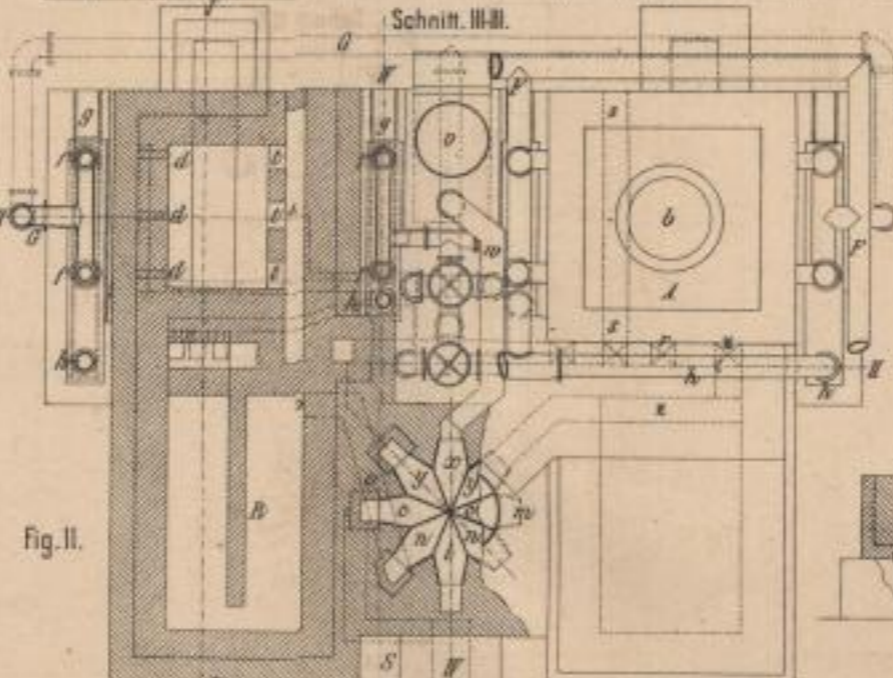
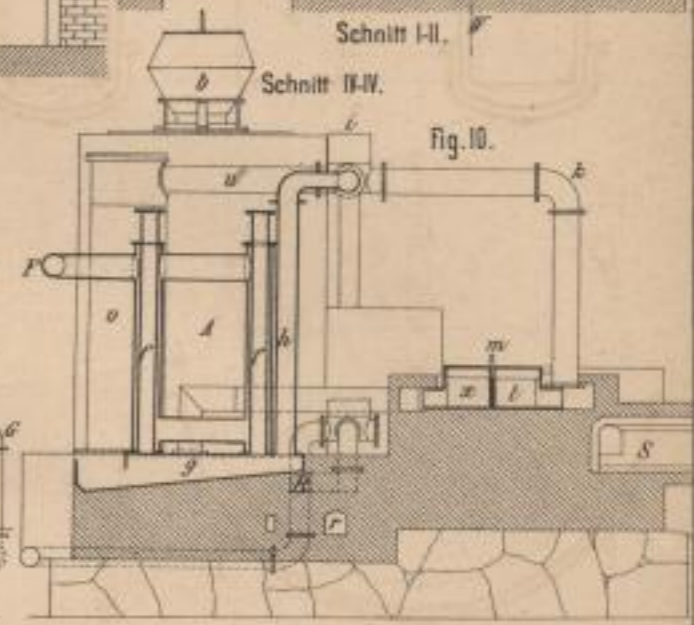
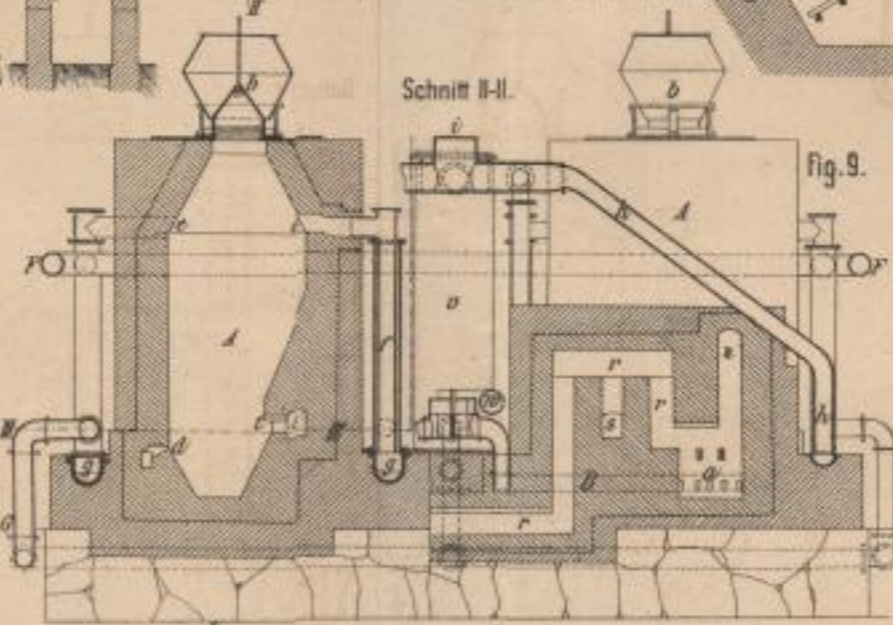
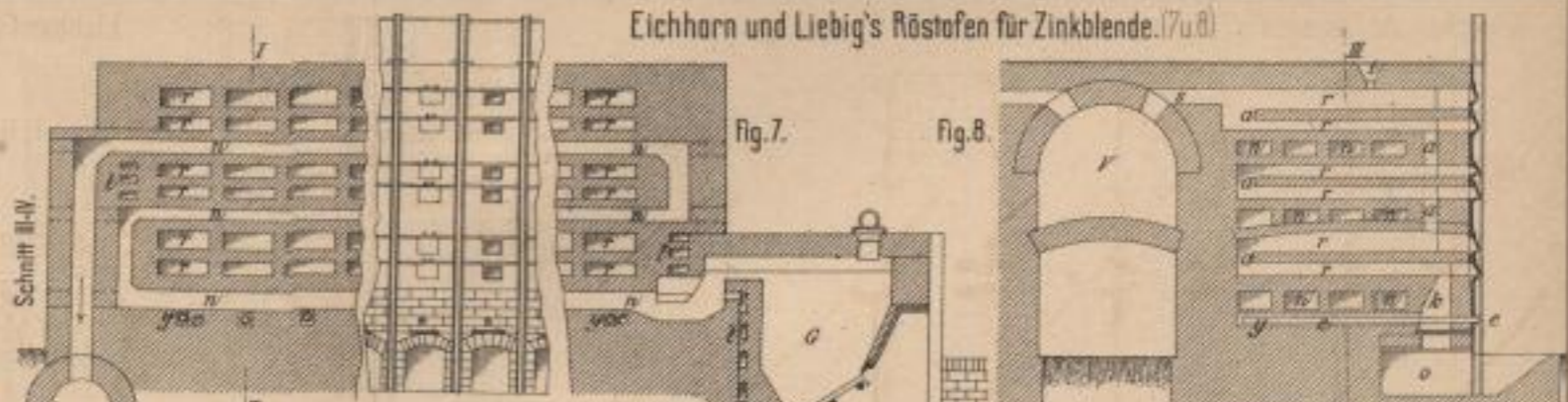

Westman's Reduktionsofen für Zinkerze. (9-12)

Neuerungen im Hüttenwesen. (Taf. 3)

Lith. Anst. v. F. W. v. Dornier

F. Ööring's Tunnel-Bohrmaschine. (1 u 2)

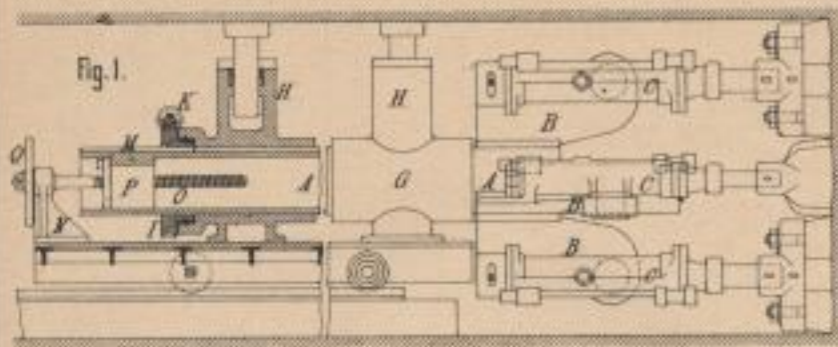

Fig. 1.

Elektrische Kraftübertragung im Bergbaue. (3-8)

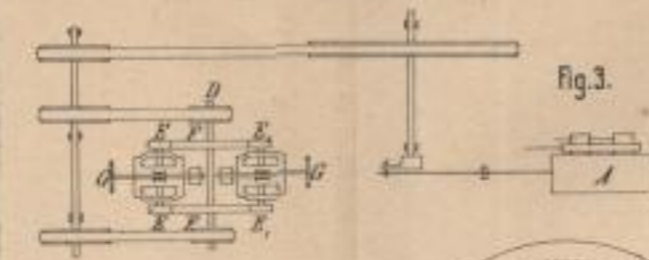

Fig. 3.



Fig. 8.

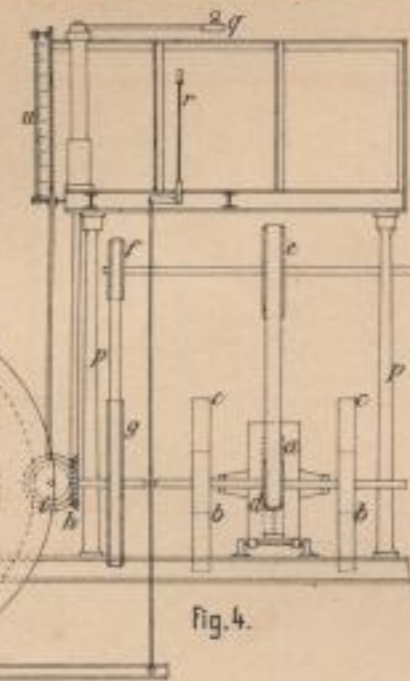

Fig. 4.

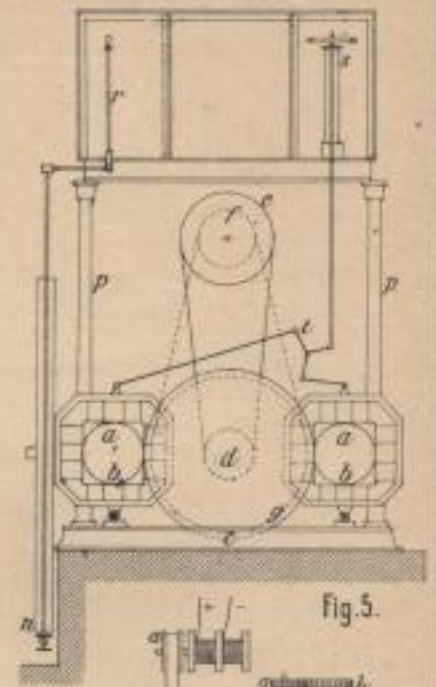

Fig. 5.

Riggenbach's Sicherheitsbremse. (9 u 10)



Fig. 9.

Fig. 10.

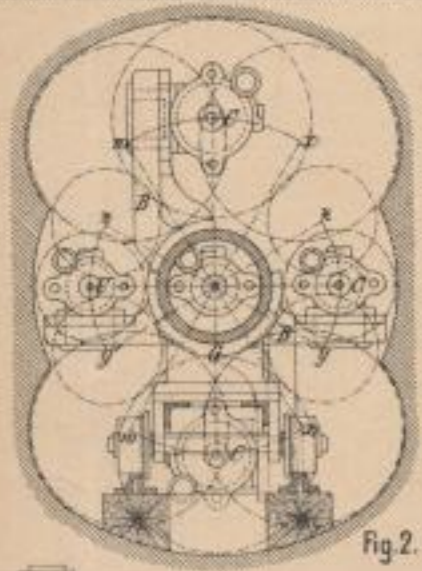

Fig. 2.

Altenloh und Brinck's Presse für Holzschrauben. (11)

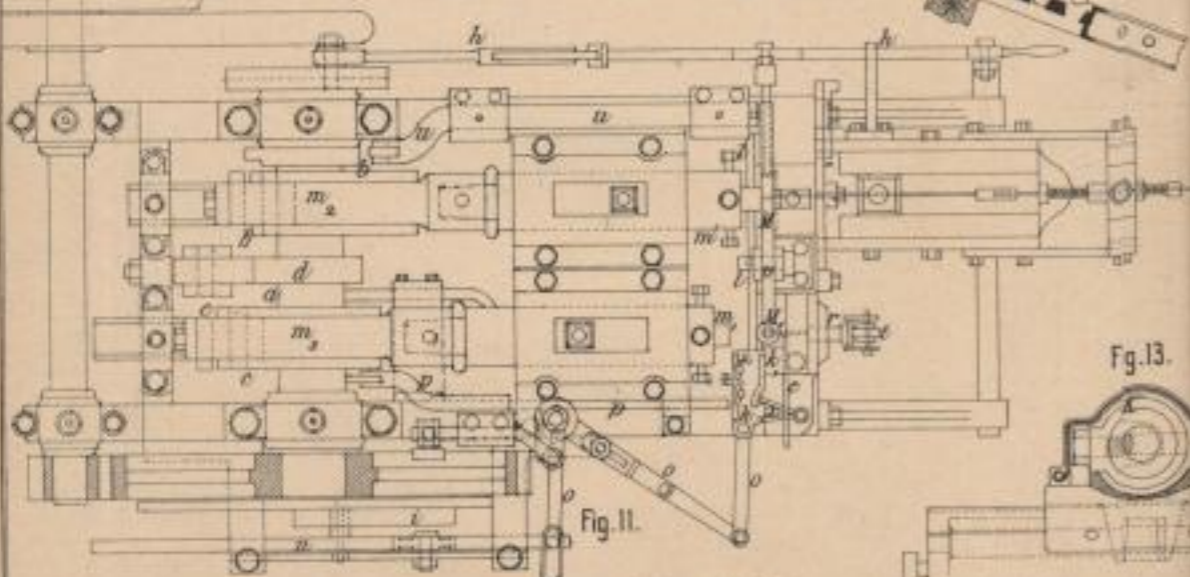

Fig. 11.

Trier's Abdrehsapparat für Schleifsteine. (12-15)

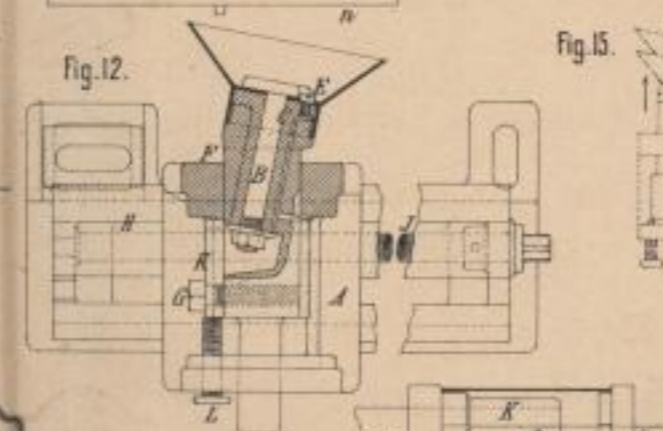

Fig. 12.

Fig. 13.

Fig. 14.

Fig. 15.

A. Hermann's Bohrknarre. (16 u 17)

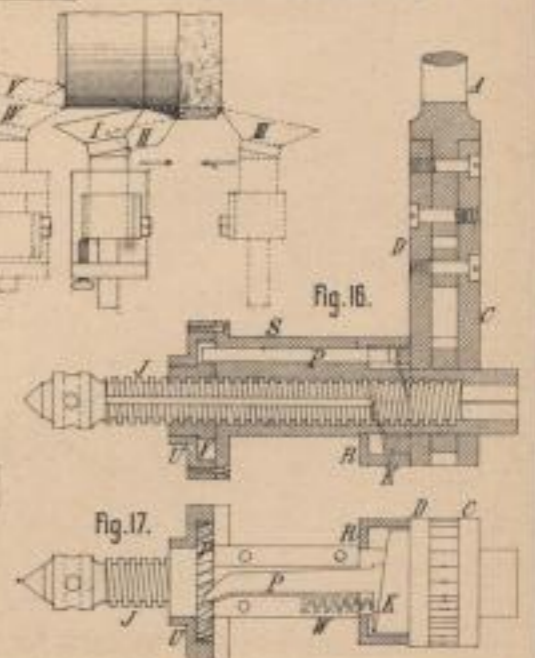
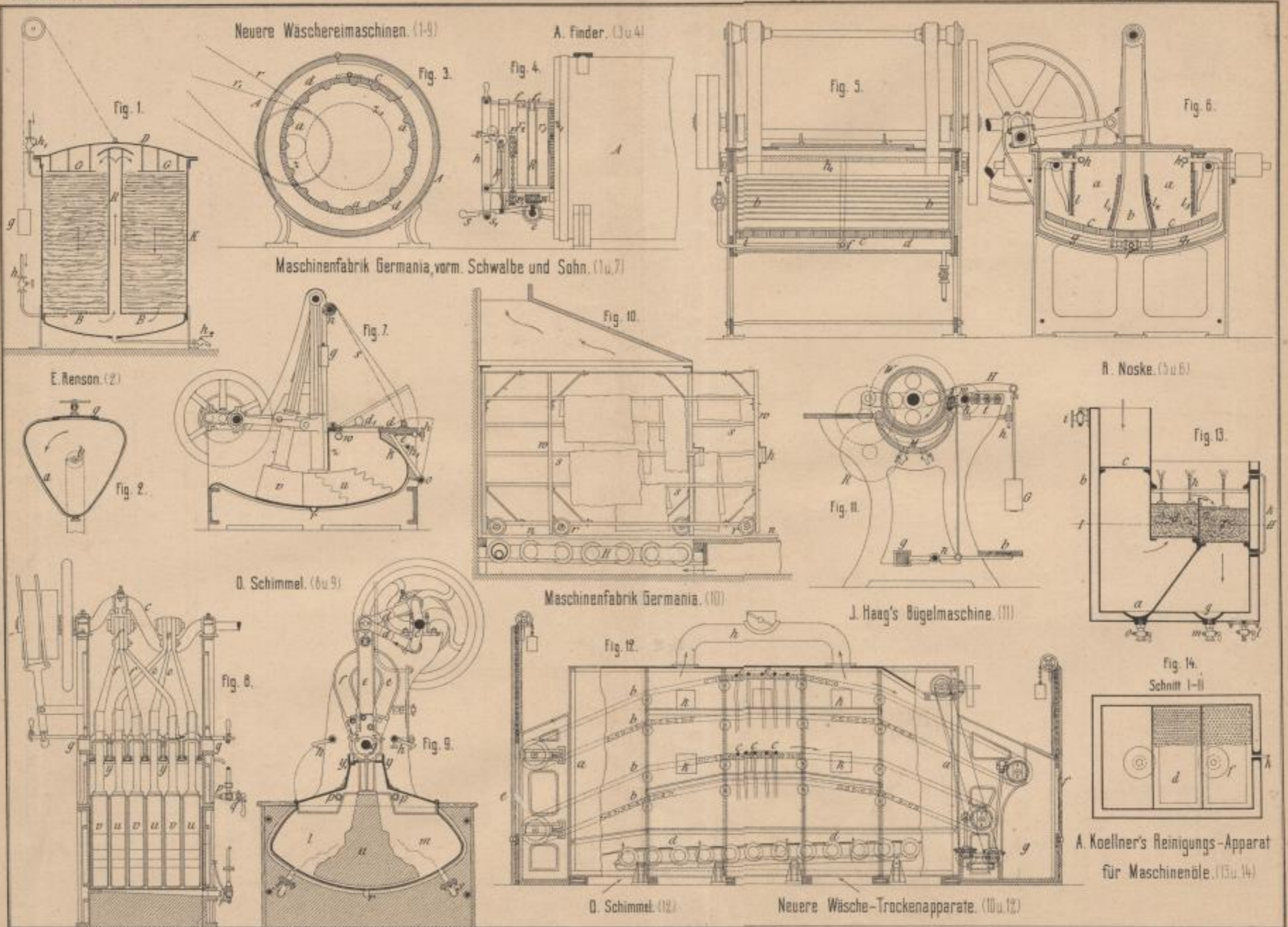

Fig. 16.

Fig. 17.

Lith. Anst. v. W. v. Bornstädt.



Neuere Wäschereimaschinen. (1-9)

A. FINDER. (3 u 4)

Maschinenfabrik Germania, vorm. Schwalbe und Sohn. (1 u 7)

E. RENSON. (2)

R. NOSKE. (5 u 6)

D. SCHIMMEL. (8 u 9)

Maschinenfabrik Germania. (10)

J. HAAG'S BÜGELMASCHINE. (11)

Fig. 14. Schnitt I-II

A. KOELLNER'S REINIGUNGS-APPARAT FÜR MASCHINENÖLE. (13 u 14)

D. SCHIMMEL. (12)

Neuere Wäsche-Trockenapparate. (10 u 12)

Lith. Anst. v. F. Wiese, Darmstadt.

Siemens und Halske. (1-3)

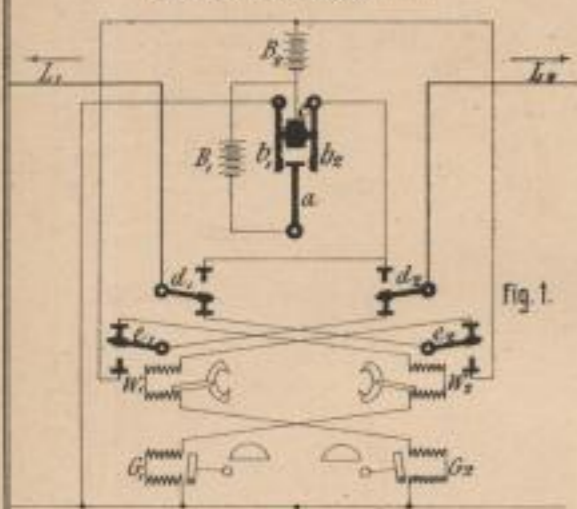

Fig. 1.

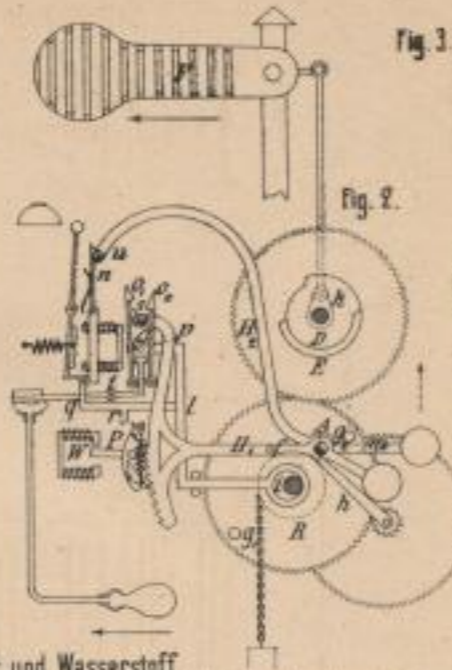

Fig. 2.

Fig. 3.

Fig. 4.

Fig. 5.

Fig. 6.

Fig. 7.

Fig. 8.

Fig. 9.

Selbstthätige Eisenbahnsignale. (1-6)

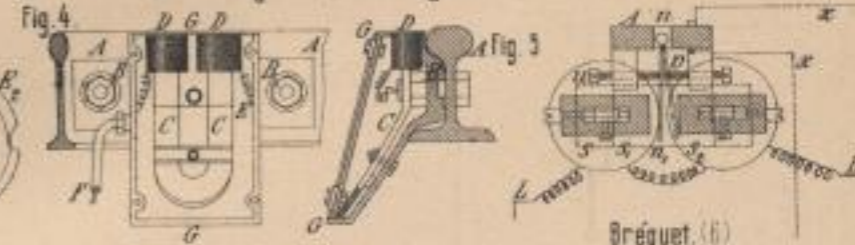

Gebr. Ducoussa. (4 u. 5)

Bréguet. (6)

Hurter: Über die Chlorindustrie. (7)

Affinität der Elemente zu Sauerstoff, Chlor und Wasserstoff.

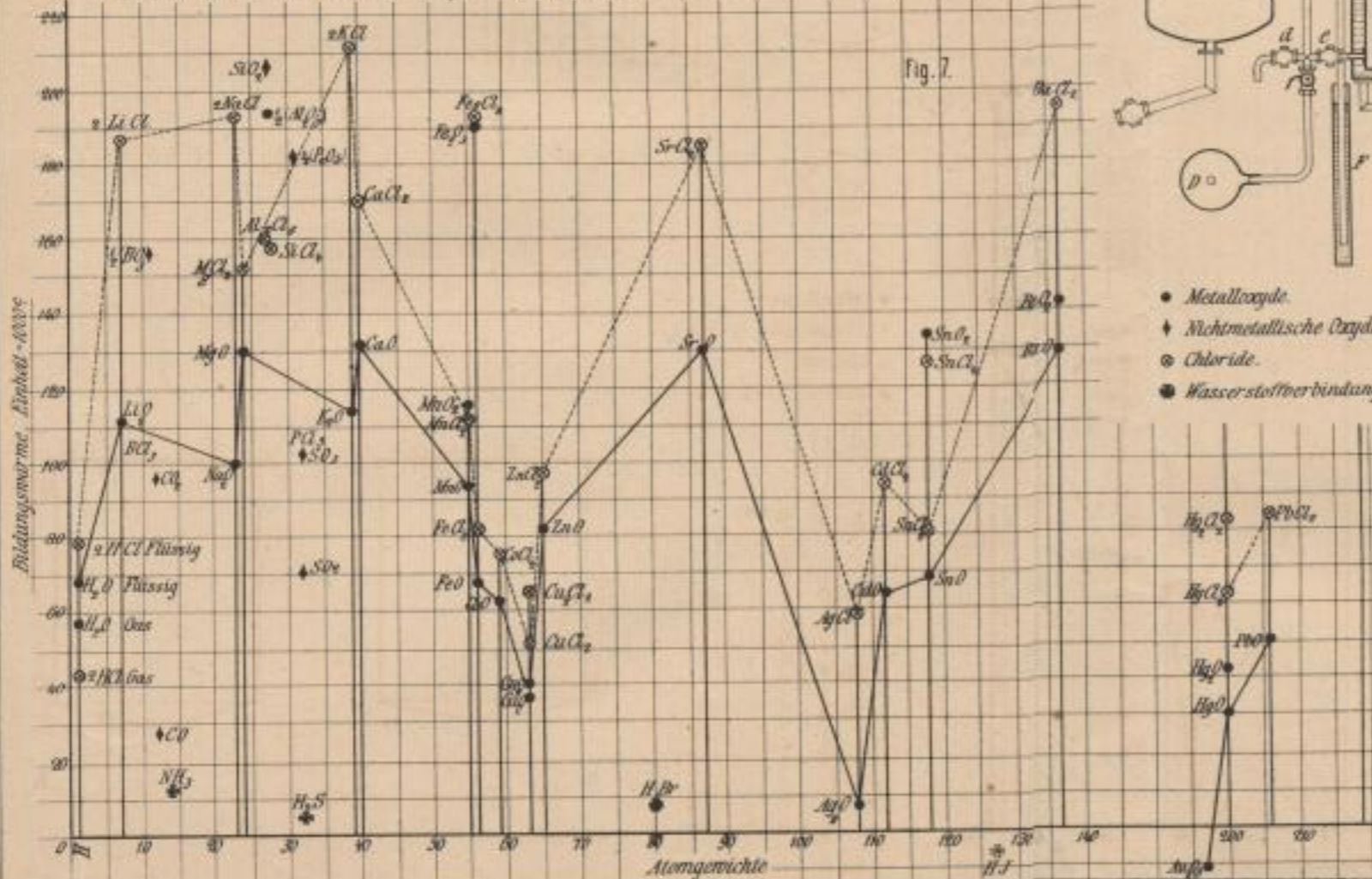

Lith. Anst. v. F. Wirtz, Darmstadt.

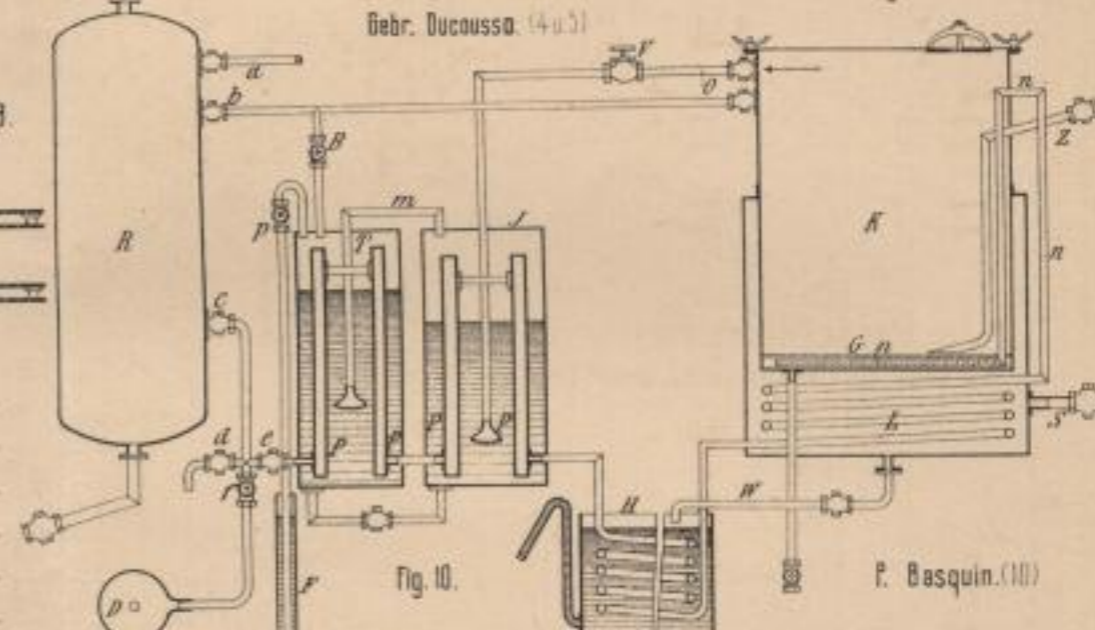

Apparate zum Bleichen und Färben. (8-11)

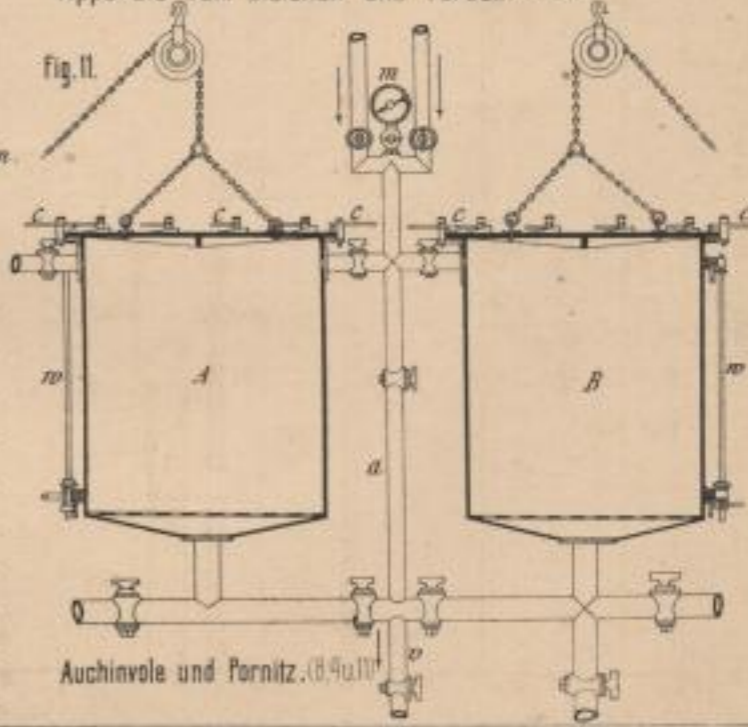

Auchivole und Pornitz. (8 u. 11)

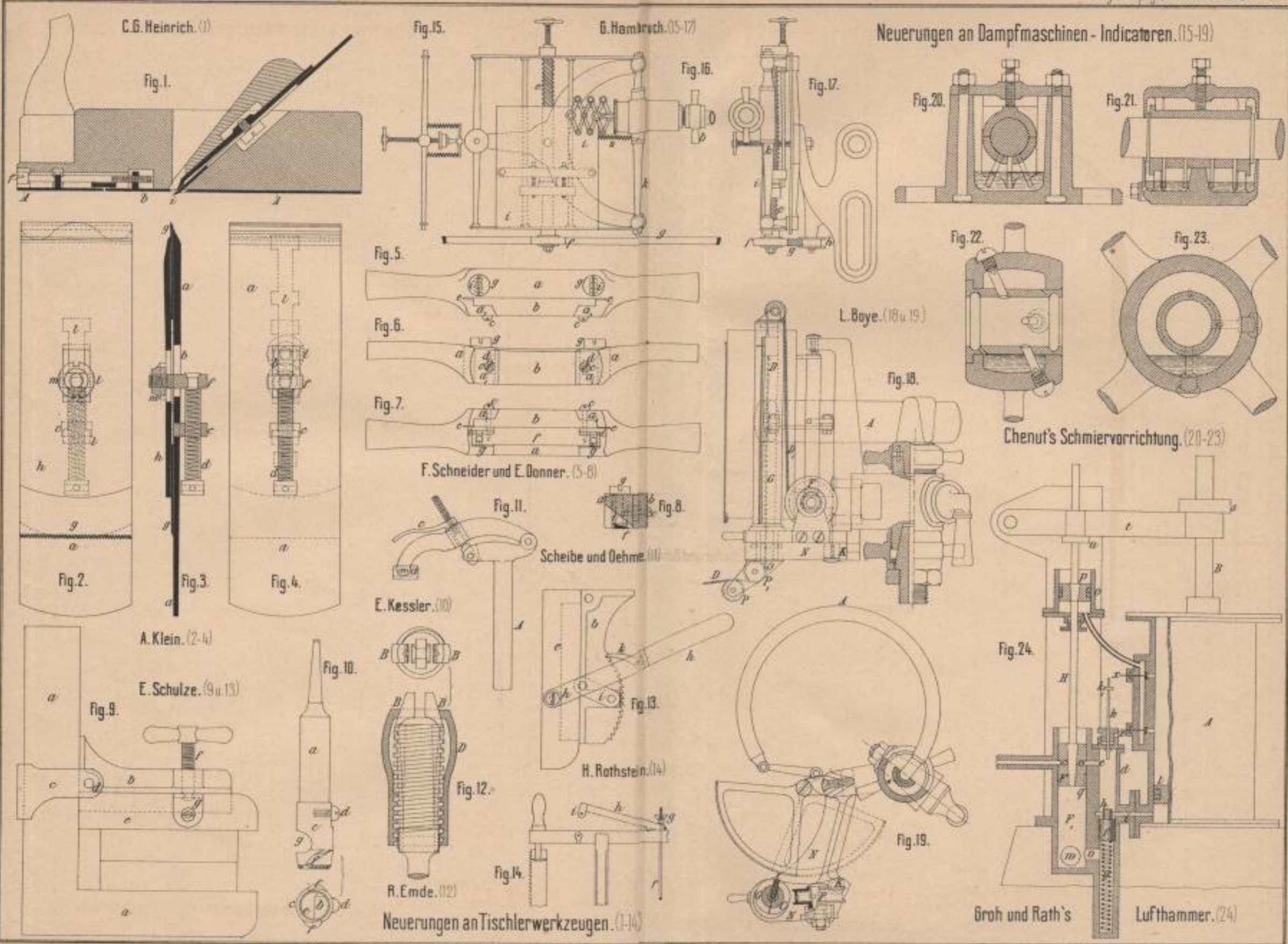

Lith. Anst. v. F. Wirtz, Darmstadt

Neuerungen an Wirkereimaschinen. (1-14)

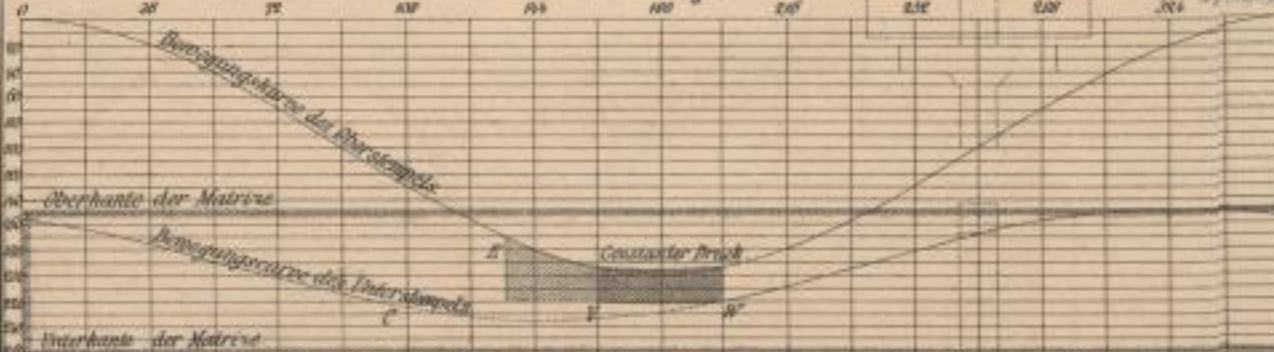
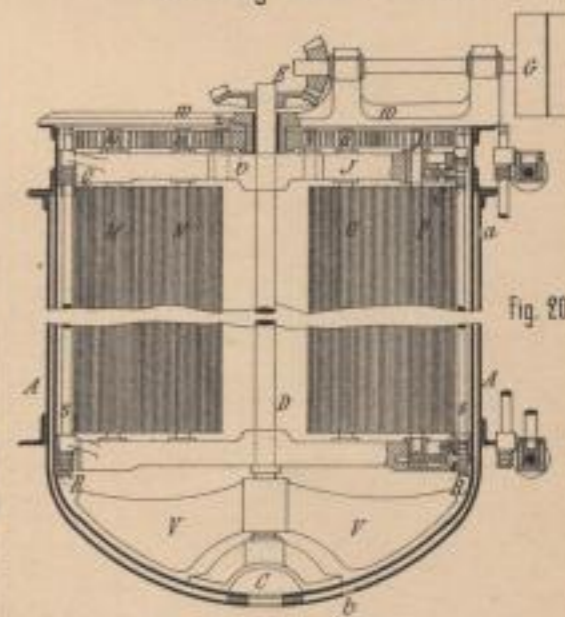
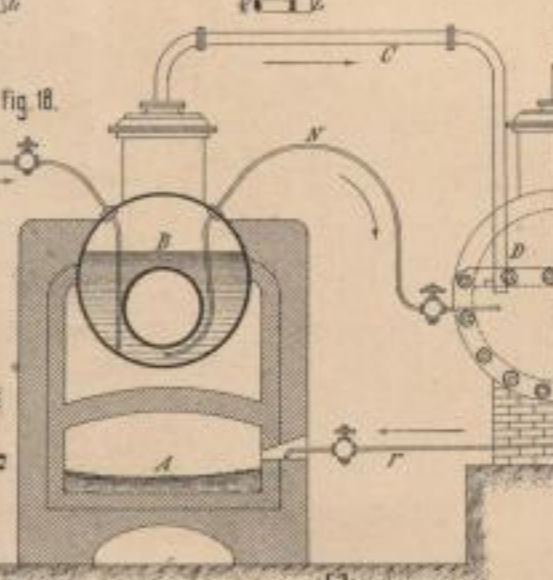
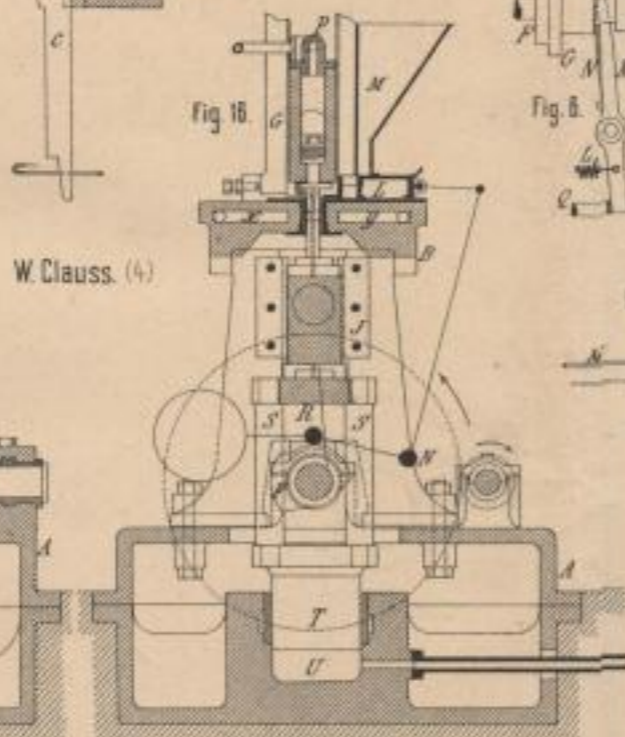
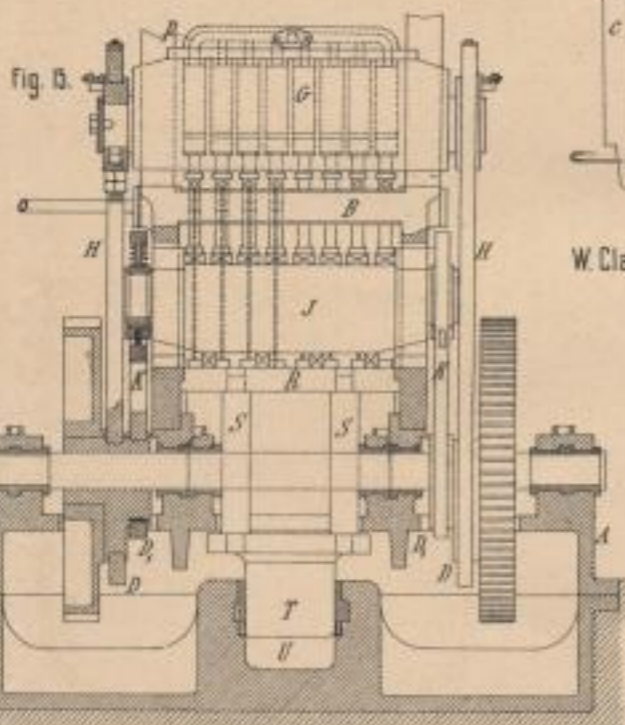
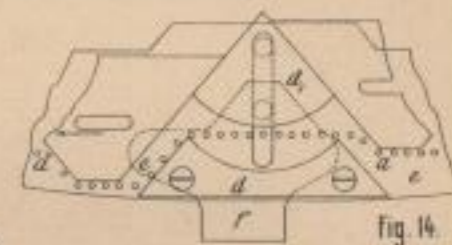
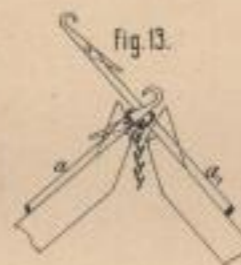
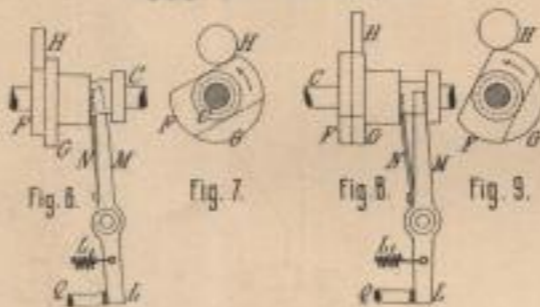
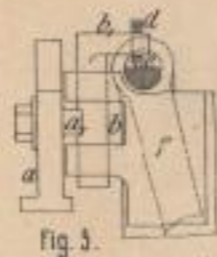
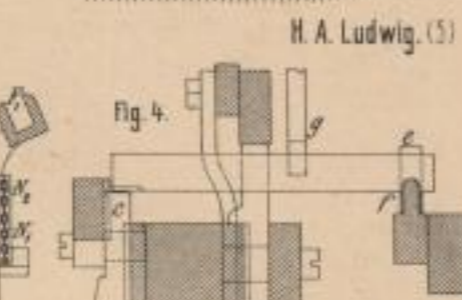
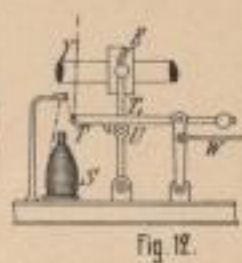
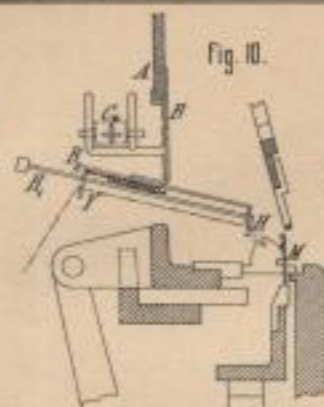
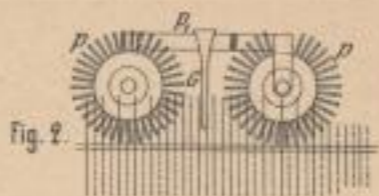
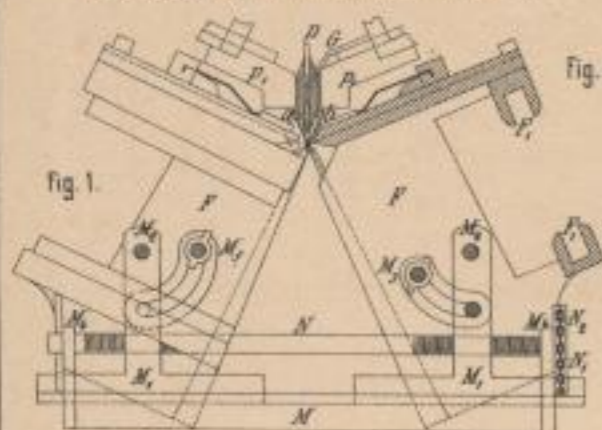

Gruson's Presse für prismatisches Pulver. (15-17)

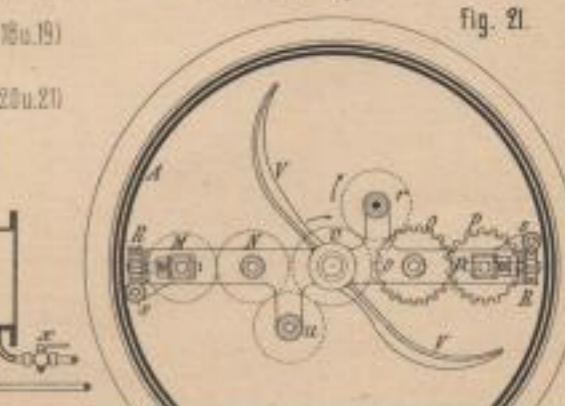
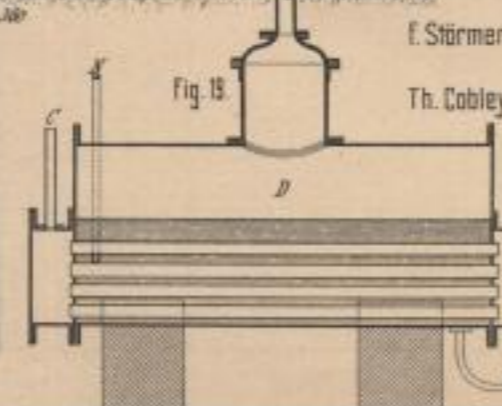

Zust. von F. Wirtz, Darmstadt.

Laurent und Collof's Filterpresse. (1-3)

H. Heckel's Verseifungsapparat. (4 u 5)

Sidersky und Probst's Herstellung von Strontiumcarbonat (6)

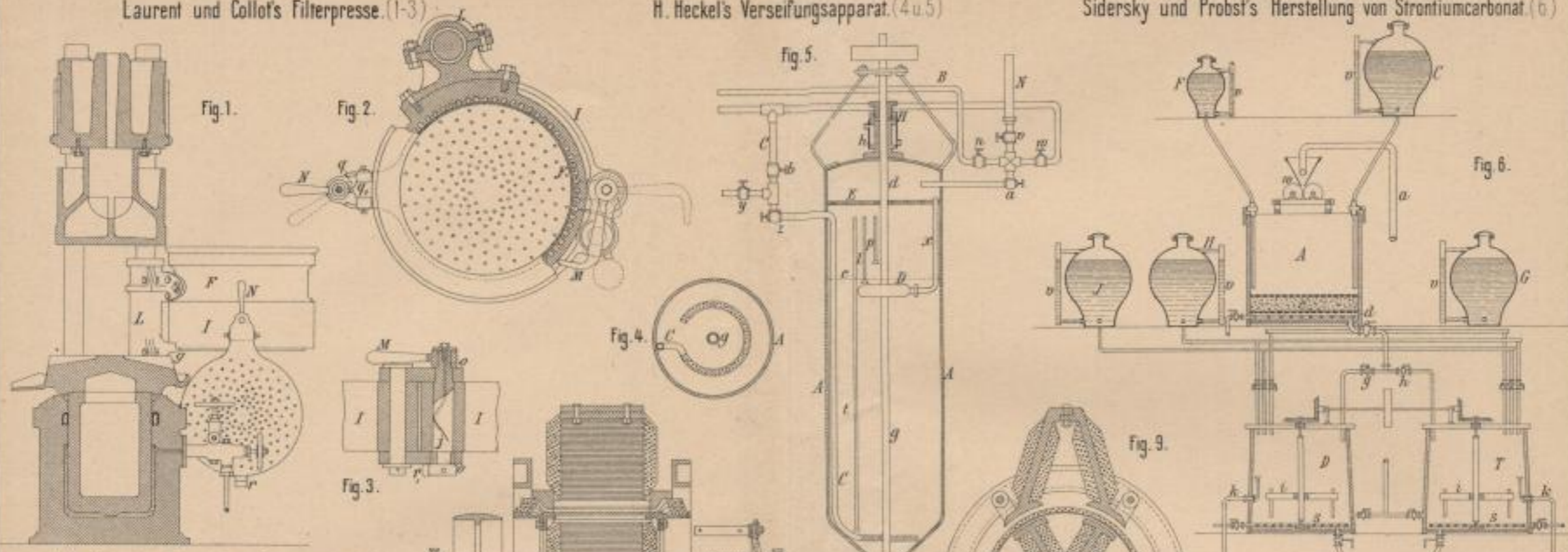

J. Hopkinson's elektrischer Strommesser. (7)

Elphinstone und C. Vincent's Dynamomaschine. (8 u 9)

A. Behl's Gasbrenner. (15)

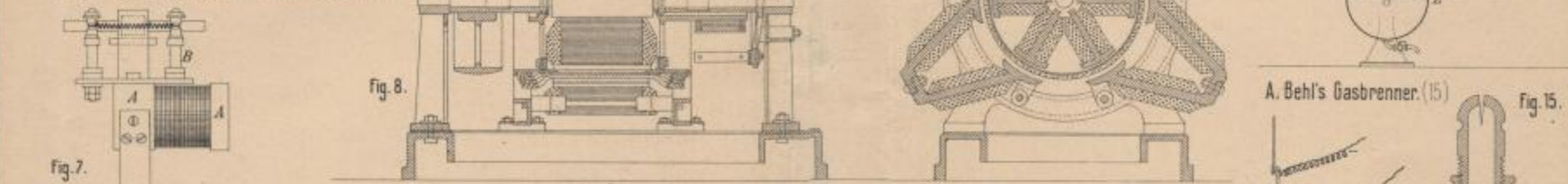

Elphinstone und C. Vincent's Dynamomaschine. (8 u 9)

R. Wagner's Nivellirinstrument. (10-12)

Kendall's Herstellung von Anilin. (13 u 14)

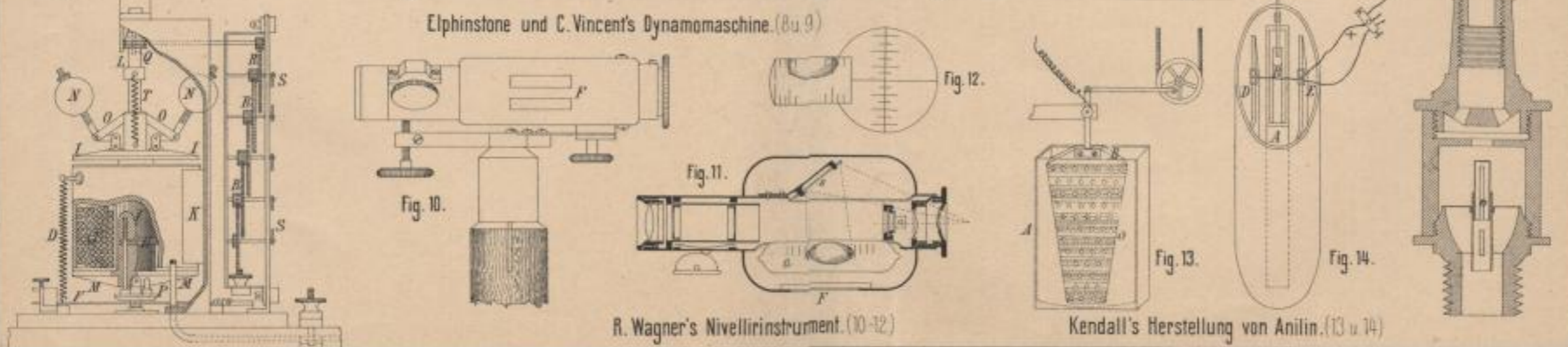

Verf. v. F. Werra, Darmstadt.

M. Schorch. (1-3)

Neuerungen an Heißluftmaschinen. (Taf. 1 u 10)

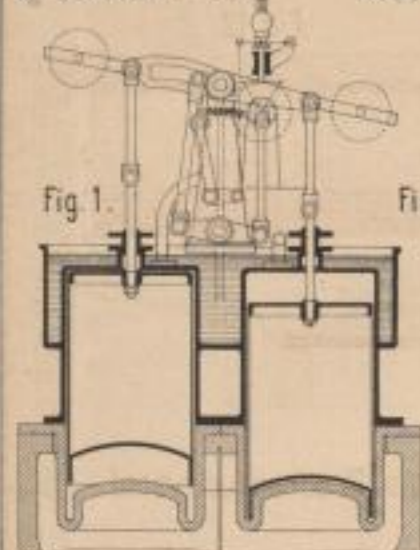

Fig. 1.

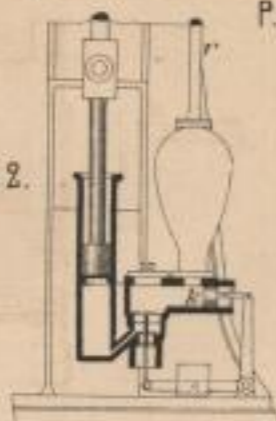

Fig. 2.

P. Lochmann. (4)

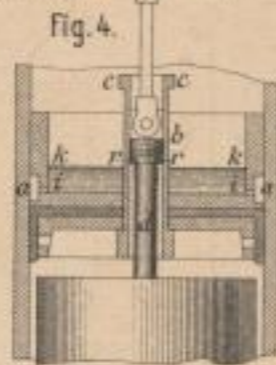

Fig. 4.

Fig. 10.

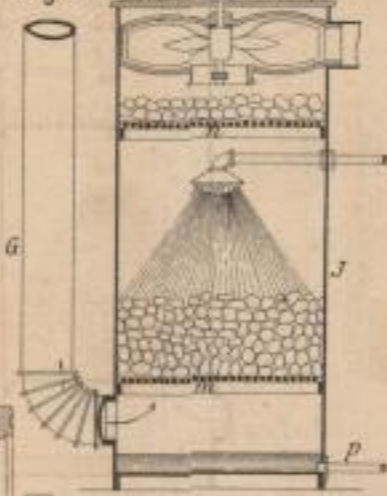

Fig. 11.

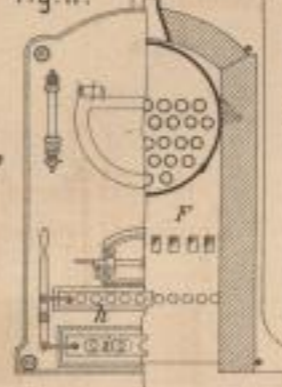
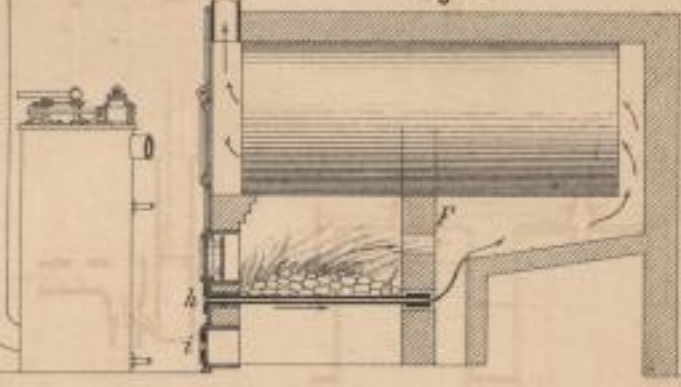

Fig. 12.



Gebr. Eimecke. (5 u 6.)

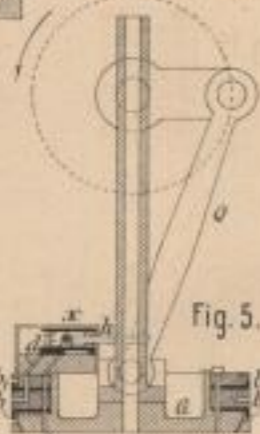

Fig. 5.

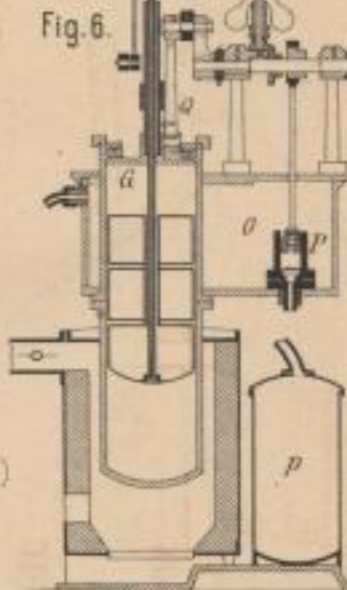

Fig. 6.

Fig. 13.



Fig. 14.



Giroud's Druckreducirventil. (13 u 16)

Fig. 15.

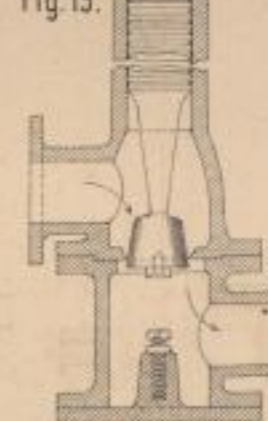
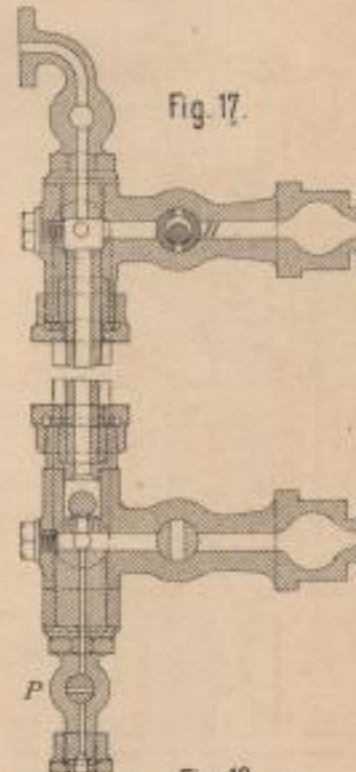

Fig. 17.



A. Monski. (9)

Fig. 9.

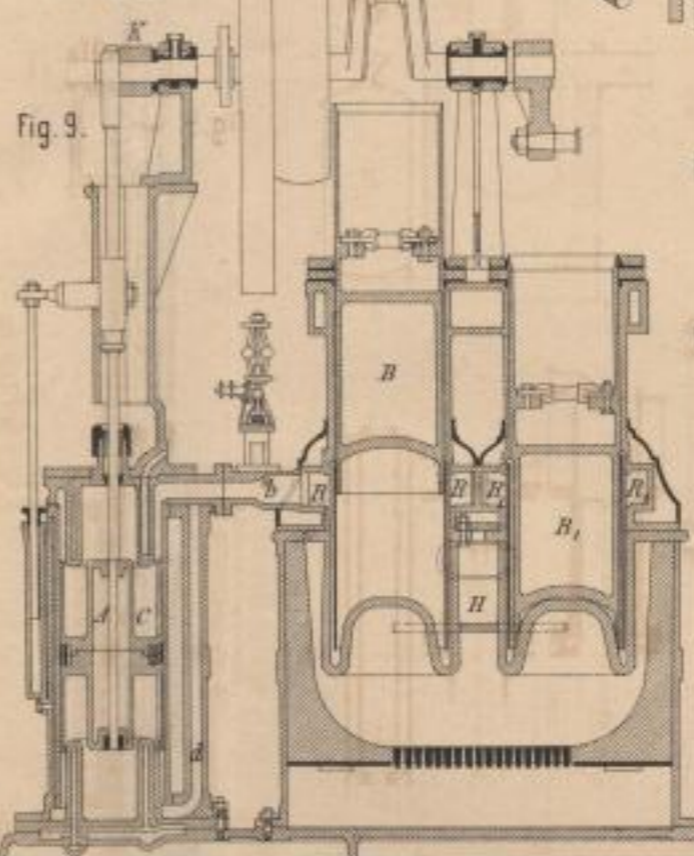

Fig. 16.

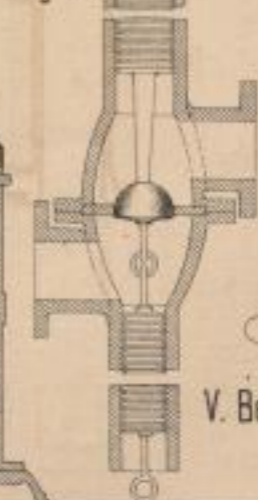
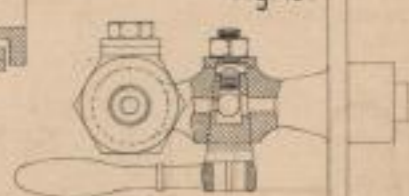

Fig. 18.



V. Bertrand's Wasserstandsglas. (17 u 18.)

Fig. 18.

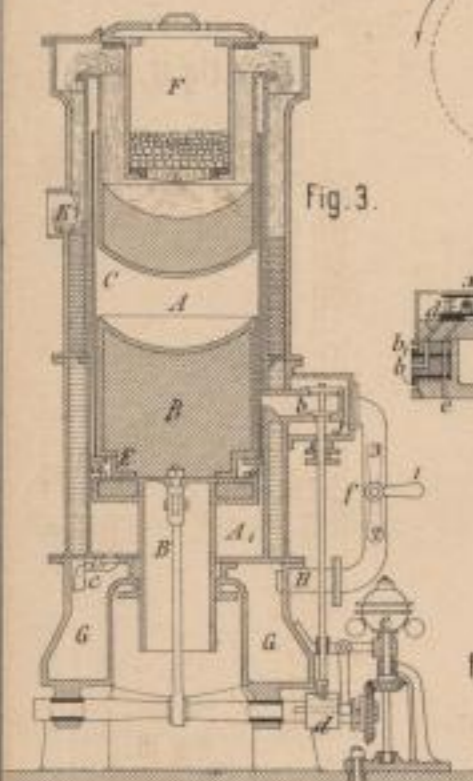

Fig. 3.

E. Nacke. (8)

Fig. 8.

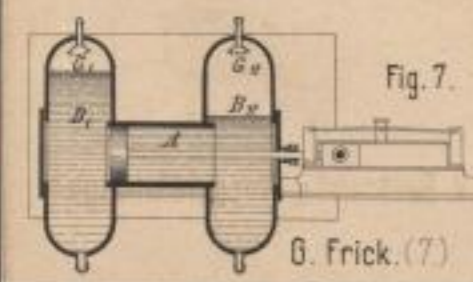
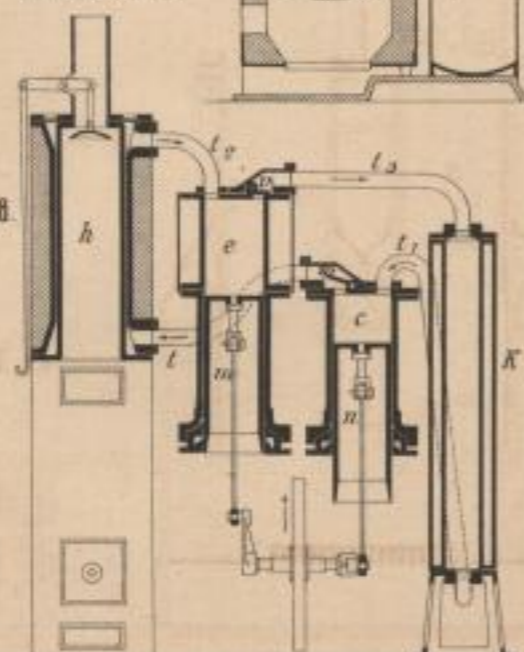
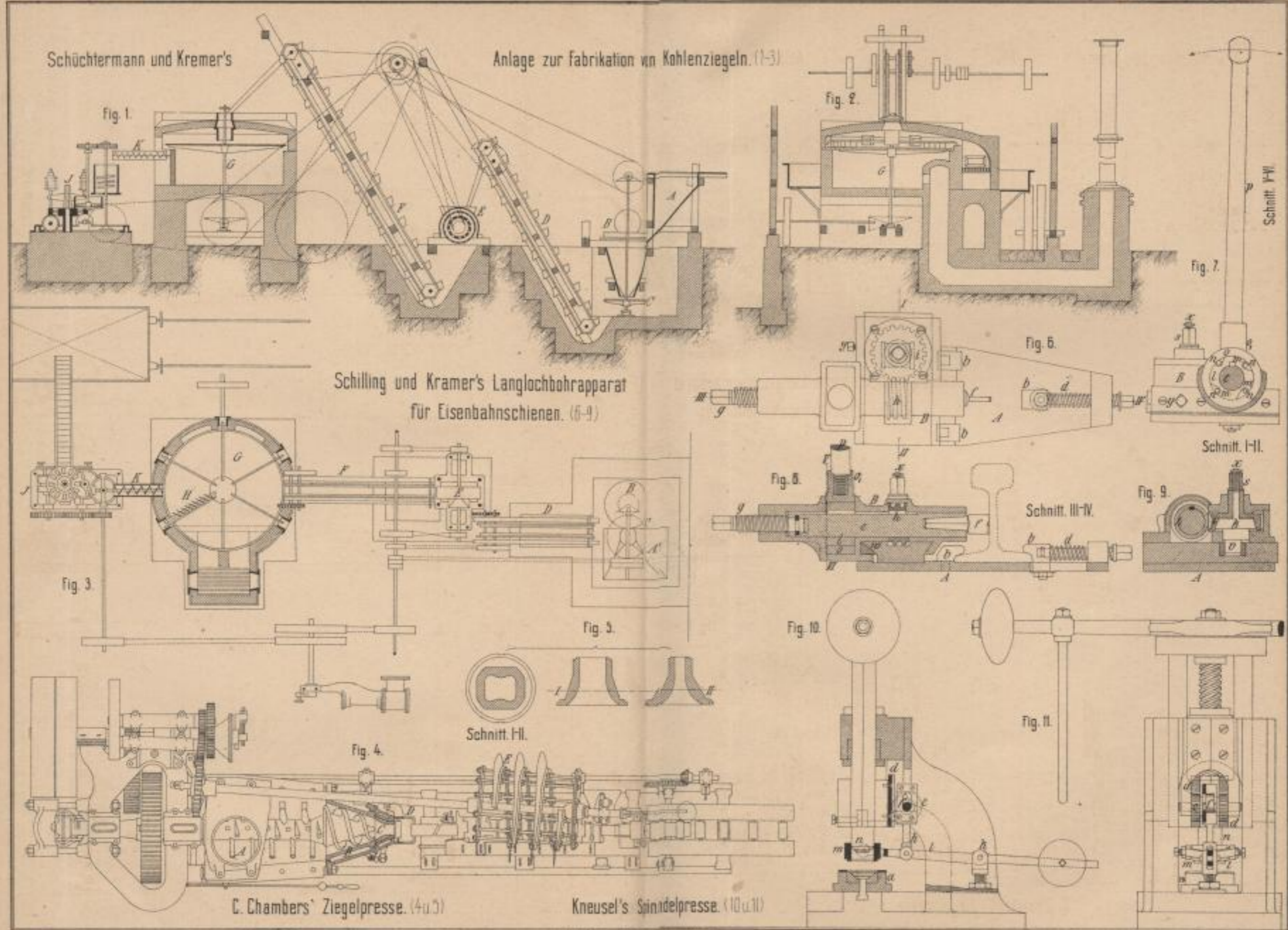

Fig. 7.

G. Frick. (7)

Lith. Anst. v. F. Weyl, Darmstadt.



Lith. Anst. v. F. Roth, Jarmstadt.

J. Merz's Extractionsapparat. (1)

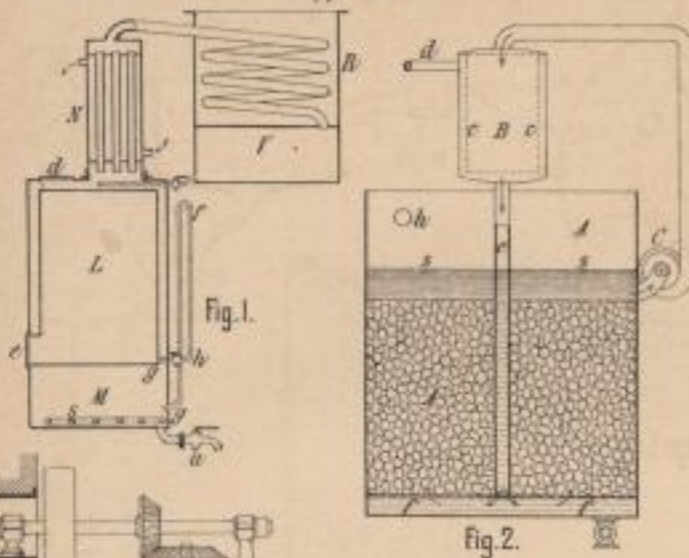

Perré und Quidet's Abdampfapparat. (3 u. 4)

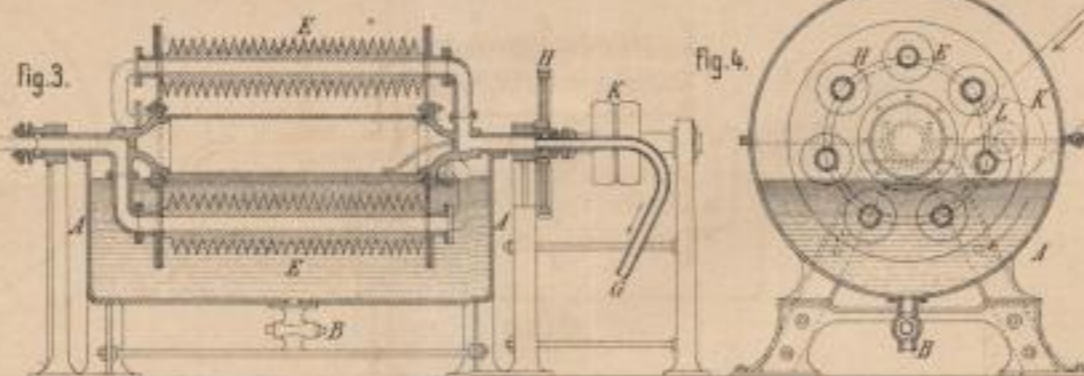

Verzyl's Reinigungsapparat für Salpeter. (5)

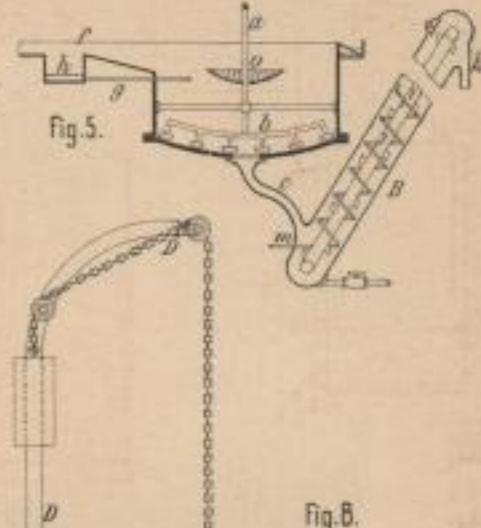

A. L. G. Dehne's Filterpresse für flüchtige Stoffe. (8 u. 9)

Naudin's Gewinnung von Riechstoffen. (7)

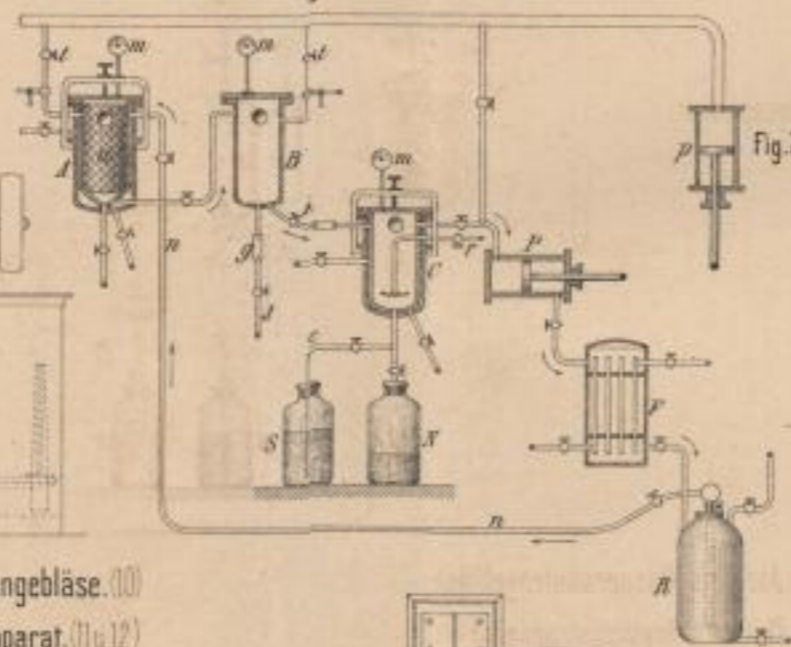

W. Küsel's bez. H. König's Auslaugeapparat. (2 bez. 6)

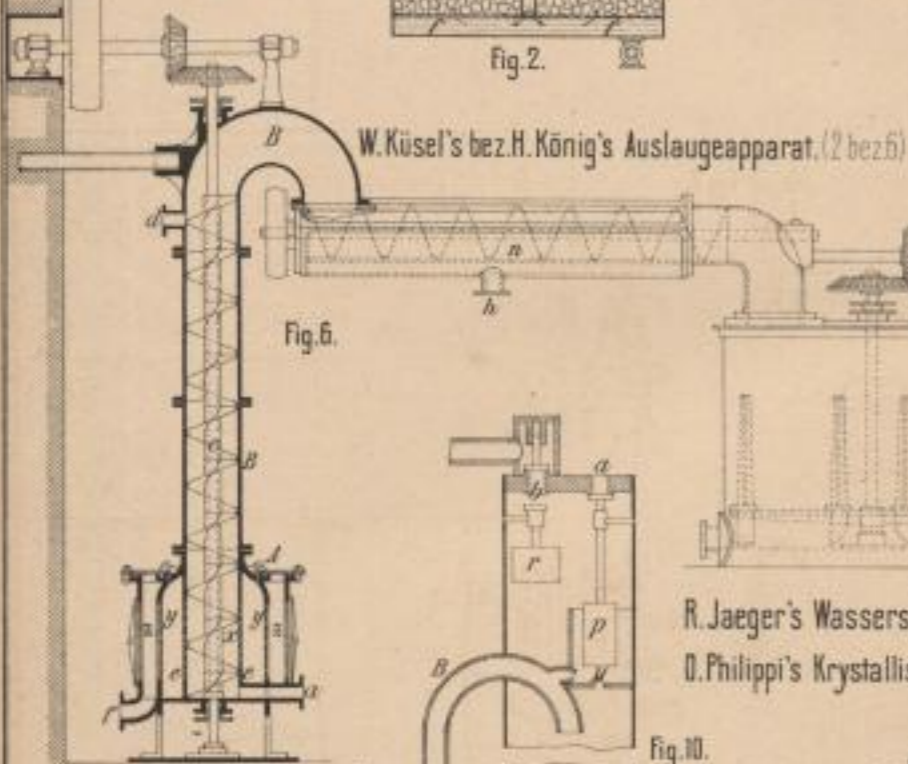

R. Jaeger's Wassersäulengebläse. (10)

D. Philippi's Krystallisirapparat. (11 u. 12)

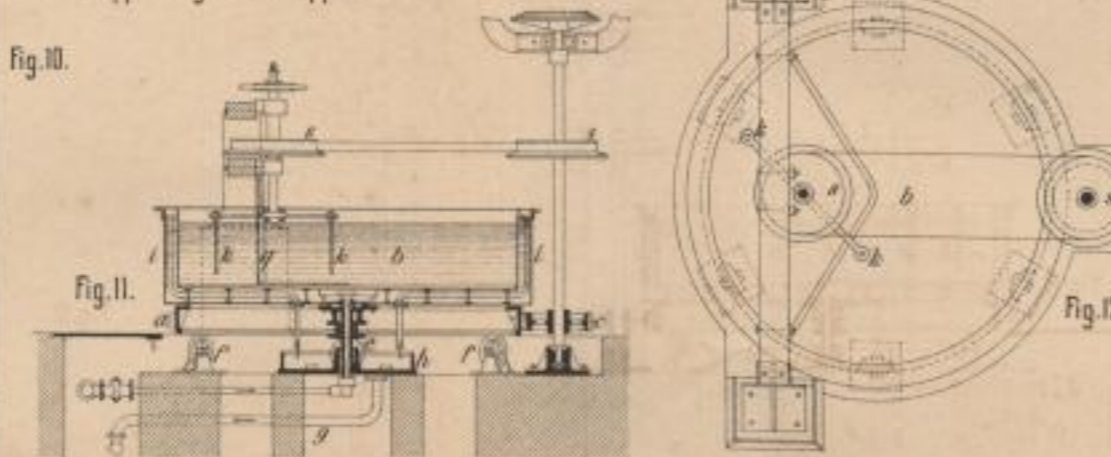

Dango und Dienenthal's Explosionsschutzklappe für Windleitungen. (13)

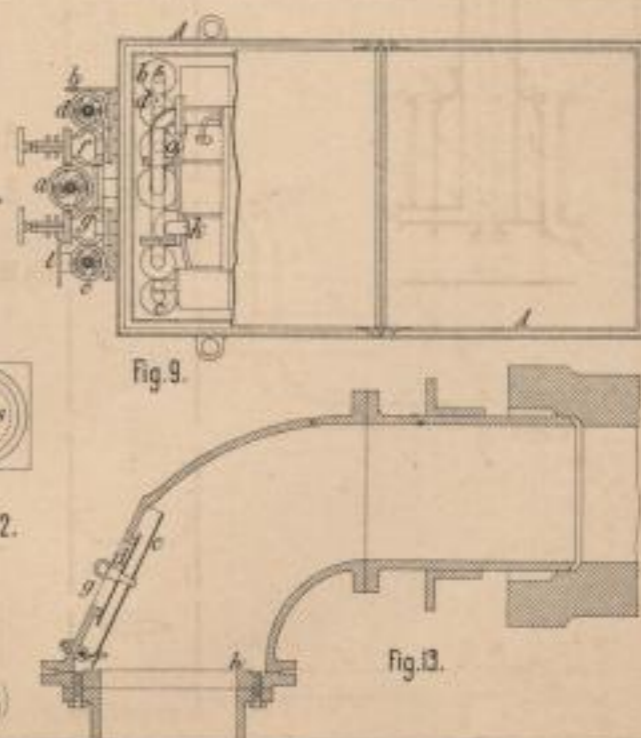

Lith. Anst. v. F. W. Nees Darmstadt.

E. Bethe's bewegliche Einmauerung für Dampfkessel. (2 u. 3)

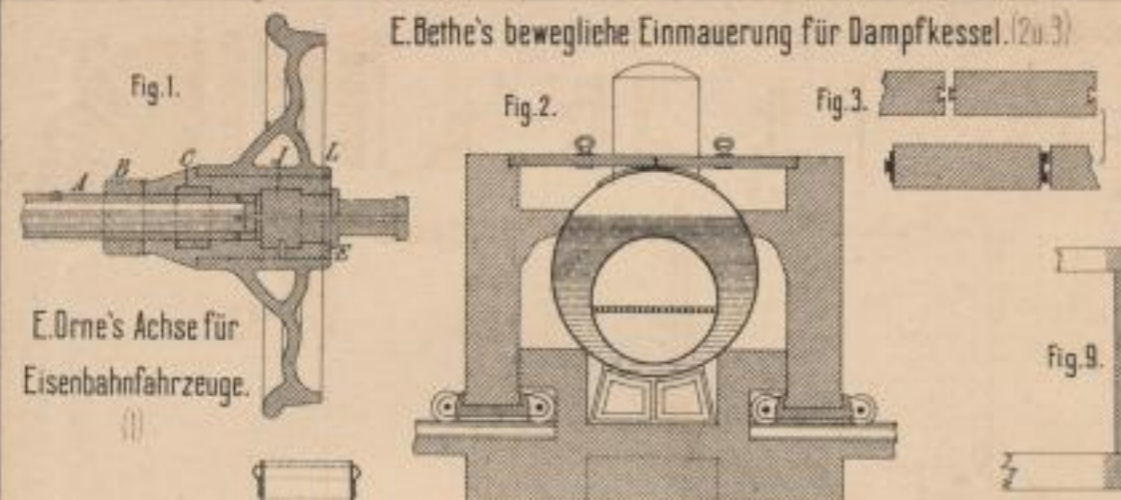

E. Orne's Achse für Eisenbahnfahrzeuge.



R. Gubbins' Wellblech-Riemenscheibe und Eisenbahnrad. (4-6)



Merryweather's Strassenlocomotive. (7)

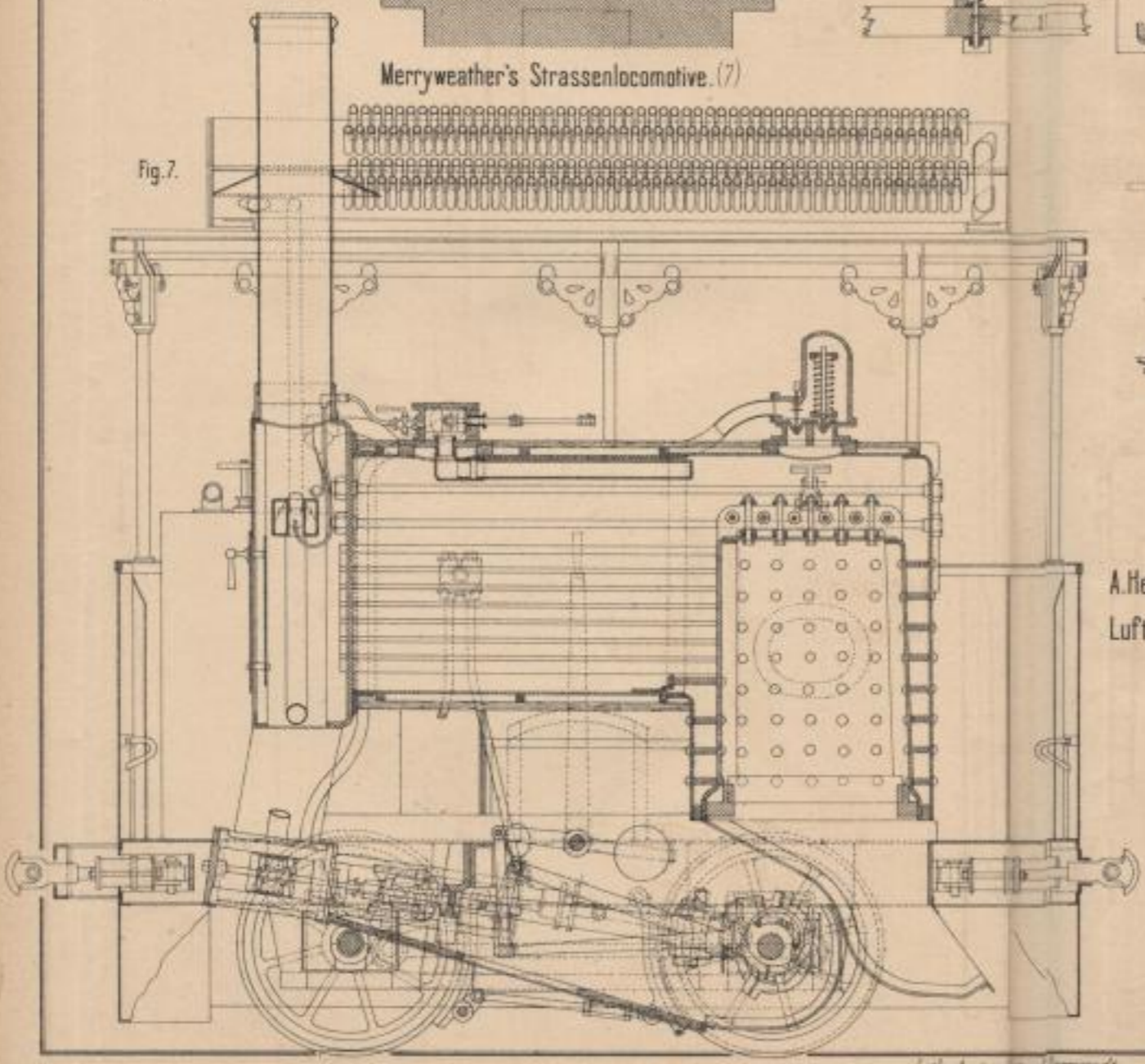

M. Martin's Sicherheitsvorrichtungen an Fahrstühlen. (9-15)

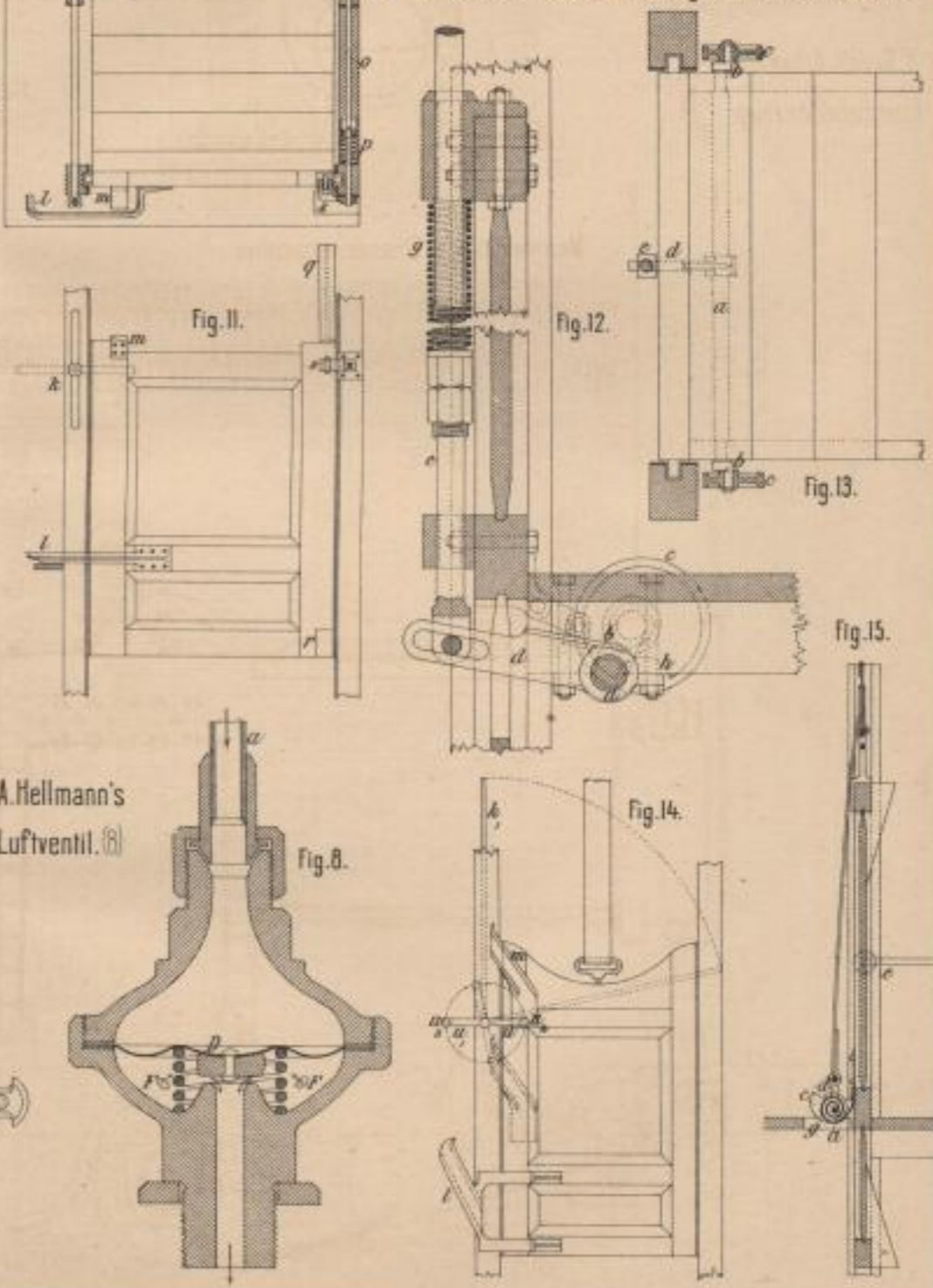

A. Hellmann's Luftventil. (8)

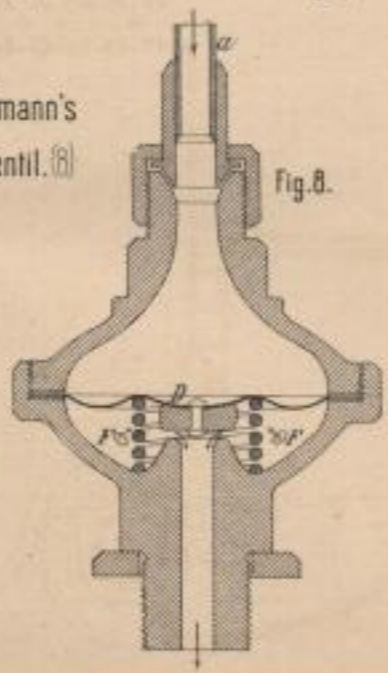

Lith. Anst. v. H. Döring.

Neuerungen in der Gespinnstfabrikation. (Taf. 14.)

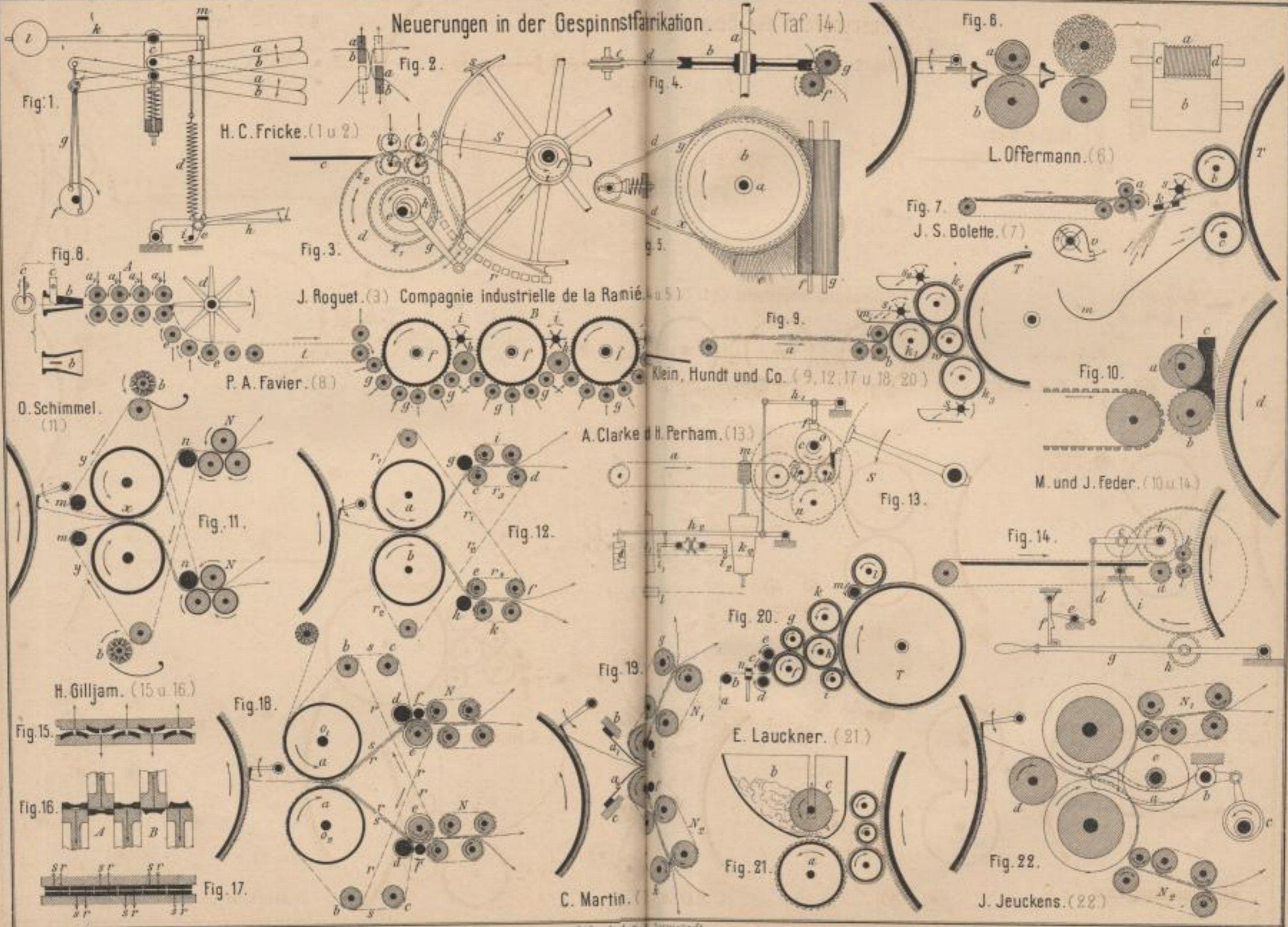

H. C. Fricke. (1 u 2)

J. Roguet. (3) Compagnie industrielle de la Ranié. (4 u 5)

P. A. Favier. (8)

D. Schimmel. (11)

A. Clarke & H. Perham. (13)

Klein, Hundt und Co. (9, 12, 17 u 18, 20)

M. und J. Feder. (10 u 14)

H. Gilljam. (15 u 16)

E. Lauckner. (21)

C. Martin. (19)

J. Jeuckens. (22)

Lith. Anst. v. J. Neumann, Neudamm

Neuerungen im Heizungs- und Lüftungswesen. (1-11)

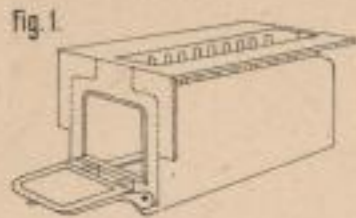

Fig. 1.

R. Müller. (1)

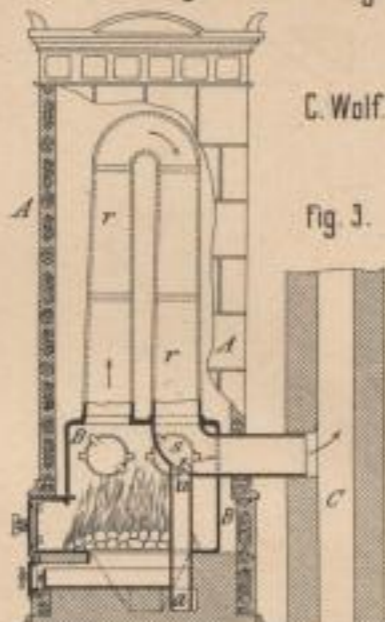

Fig. 2.

Eisenwerk Kaiserslautern. (5u6, 8u9)

Fig. 5.

C. Wolf. (3u4)



Fig. 3.

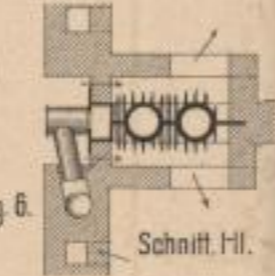

Fig. 4.

Fig. 6.

Schnitt. Hl.

Eisenwerk Lauchhammer. (2) Rottenburg. (7)

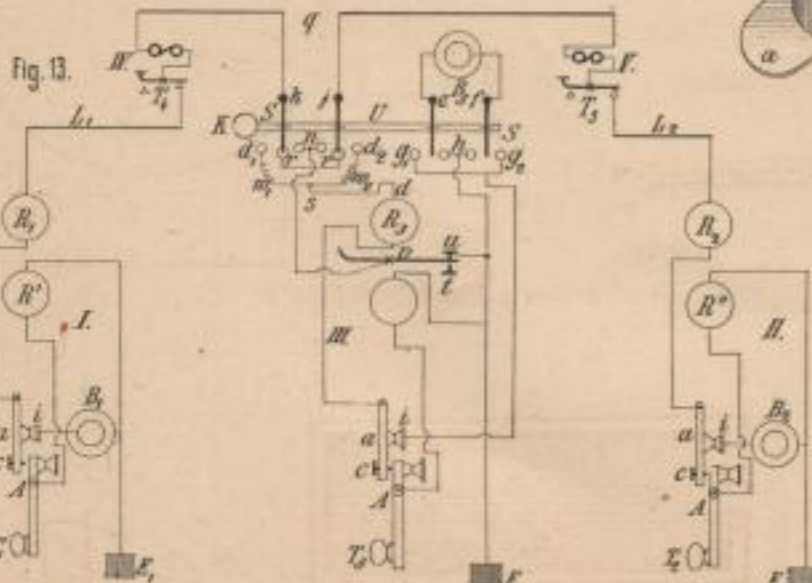

Fig. 13.

Zetzsche's Gegensprecher für Ruhestrom. (13)

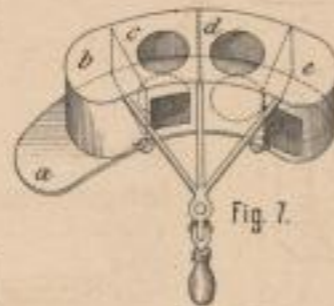

Fig. 7.

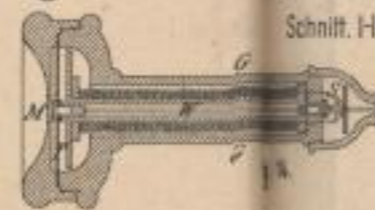
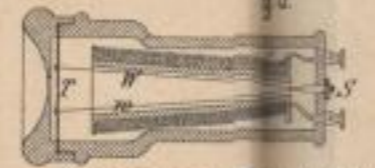

Fig. 8.

Schnitt. Hl.



R. Thompson's Tabak. (14-17)

Fig. 16.

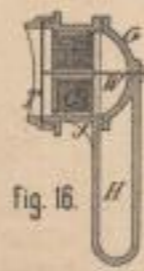

Wolpert. (10)

J. Musgrave. (11)

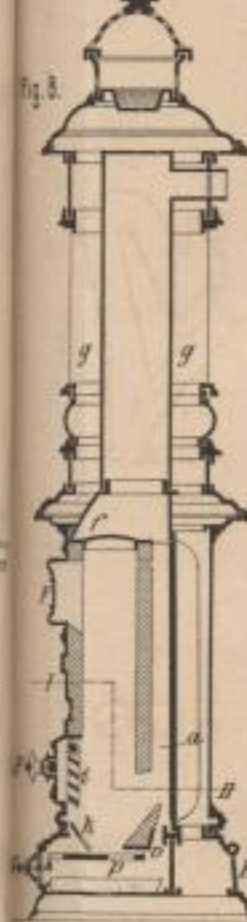

Fig. 9.

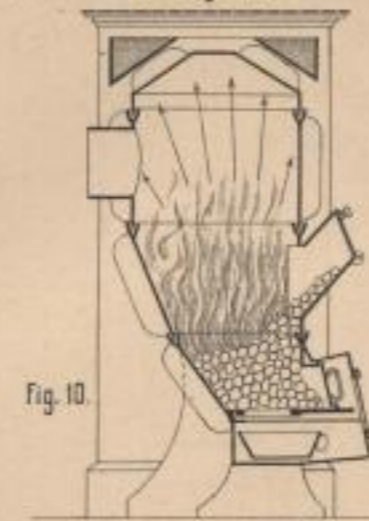

Fig. 10.

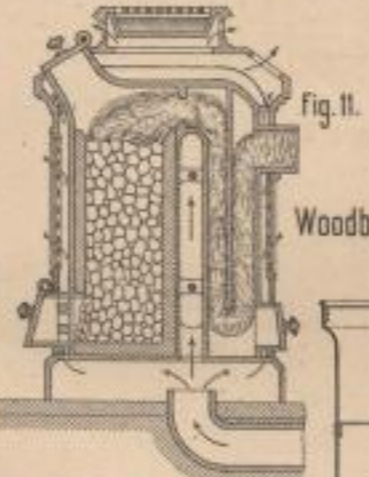

Fig. 11.

Woodbury's elektrischer Untersuchungsapparat. (12)

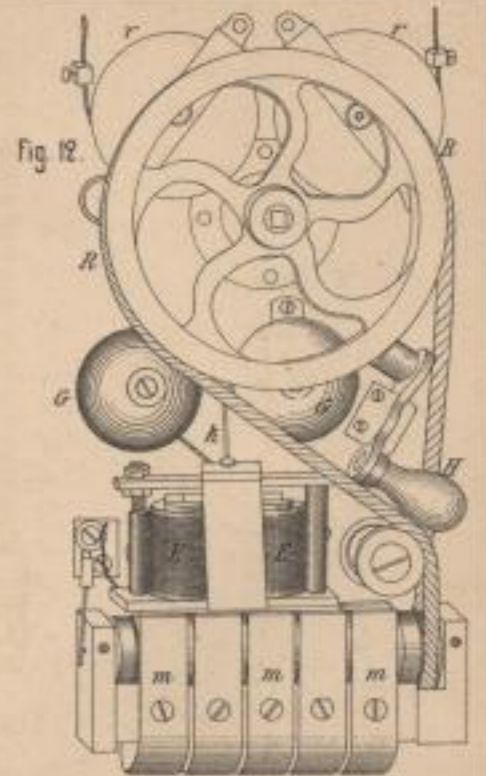

Fig. 12.

W. Nussbeck's Bettfedern-Reinigungsmaschine. (18)

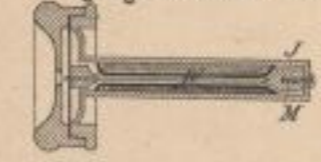

Fig. 17.

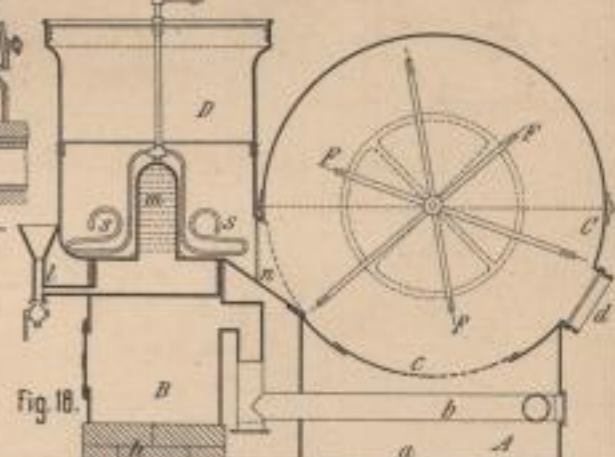

Fig. 18.

E. Gruner's Desinfectionsapparat. (19)

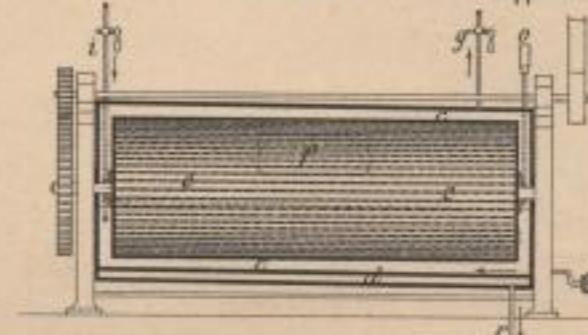
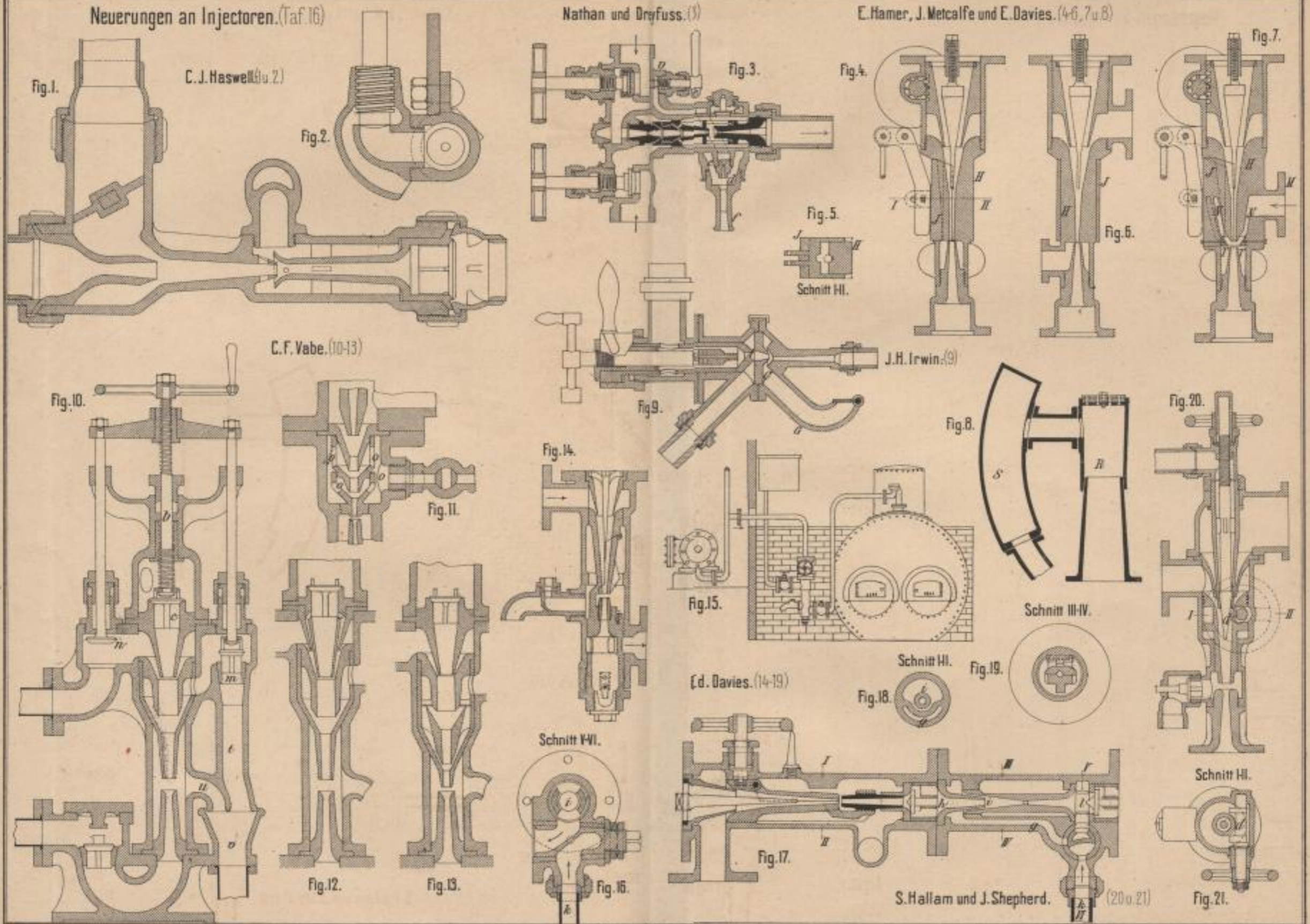

Fig. 19.

Lith. Anst. v. F. v. Linnstadt.

Neuerungen an Injectoren. (Taf. 16)



Lith. Anst. v. W. v. ...

Ganz's Formmaschine zum Formen geriffelter Speisewalzen. (1-6)

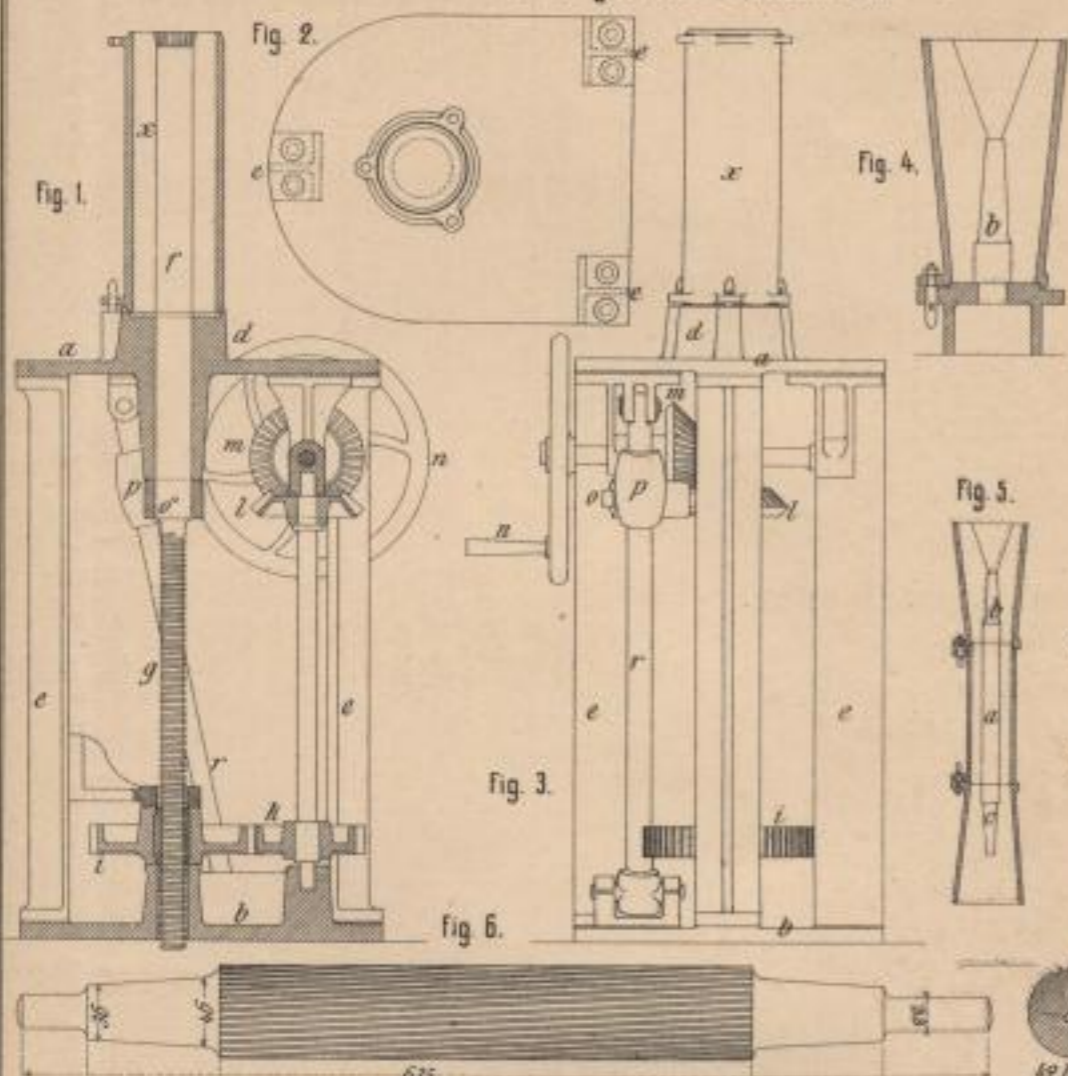

H. Howaldt's Plattenbiegemaschine. (10-12)

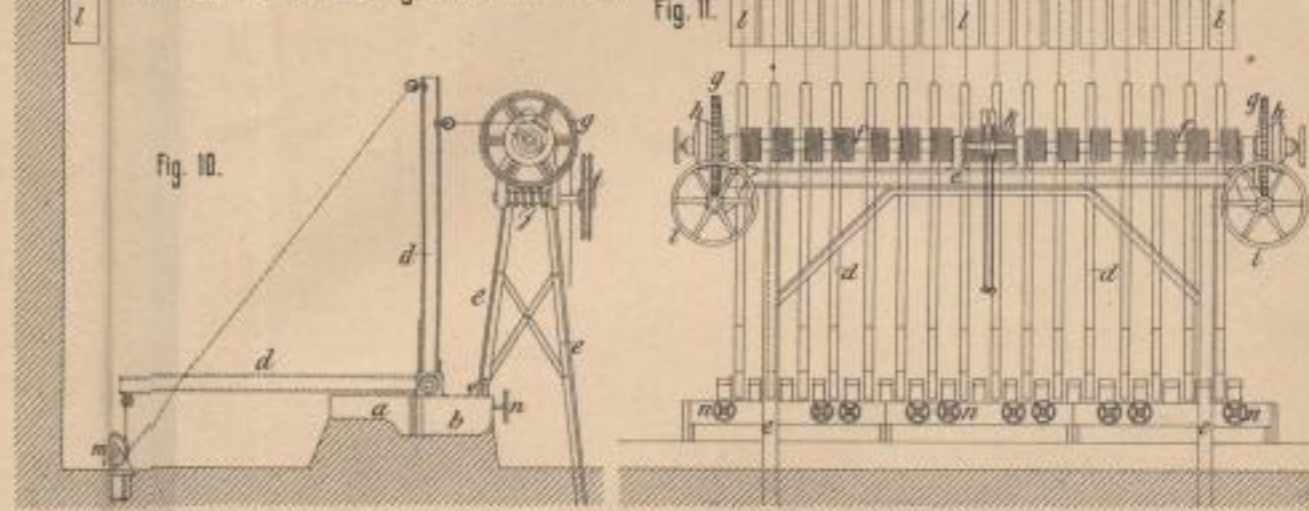

Th. Baum's Support für Muttern. (7-9)

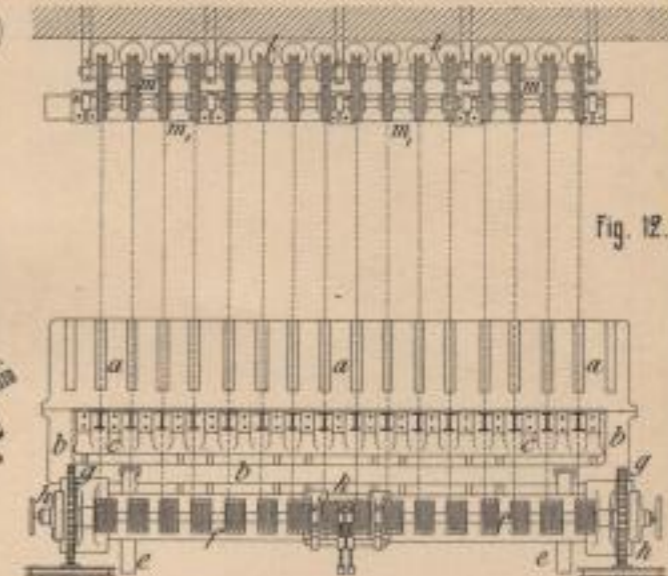
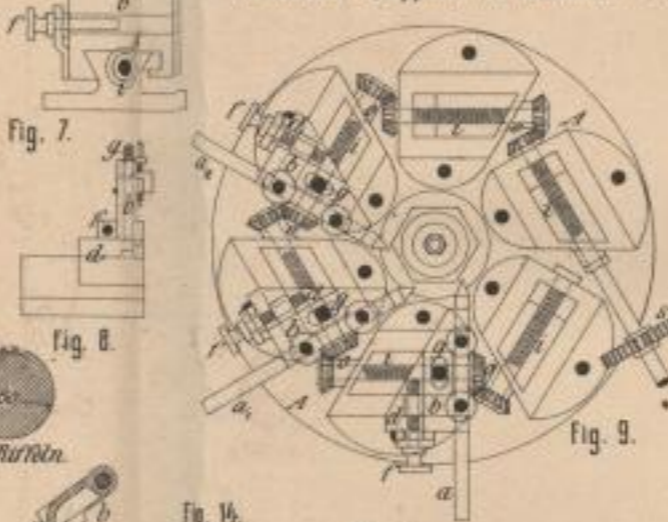

Boursset und Weiler's Einstreich-Fräsmaschine. (13 u. 16)

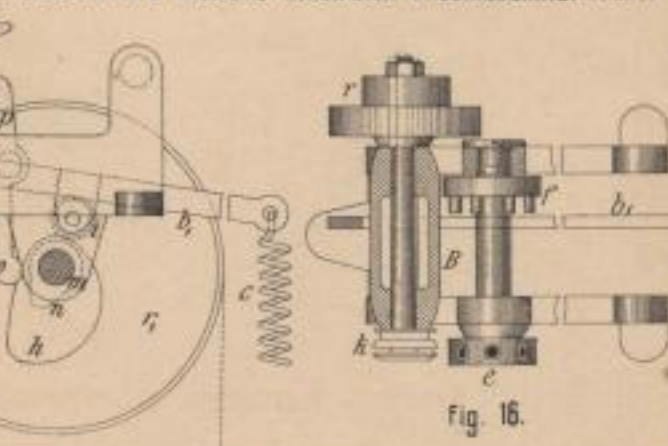

Henschel's Neuerungen an Gewindeschneidmaschinen. (13 u. 14)

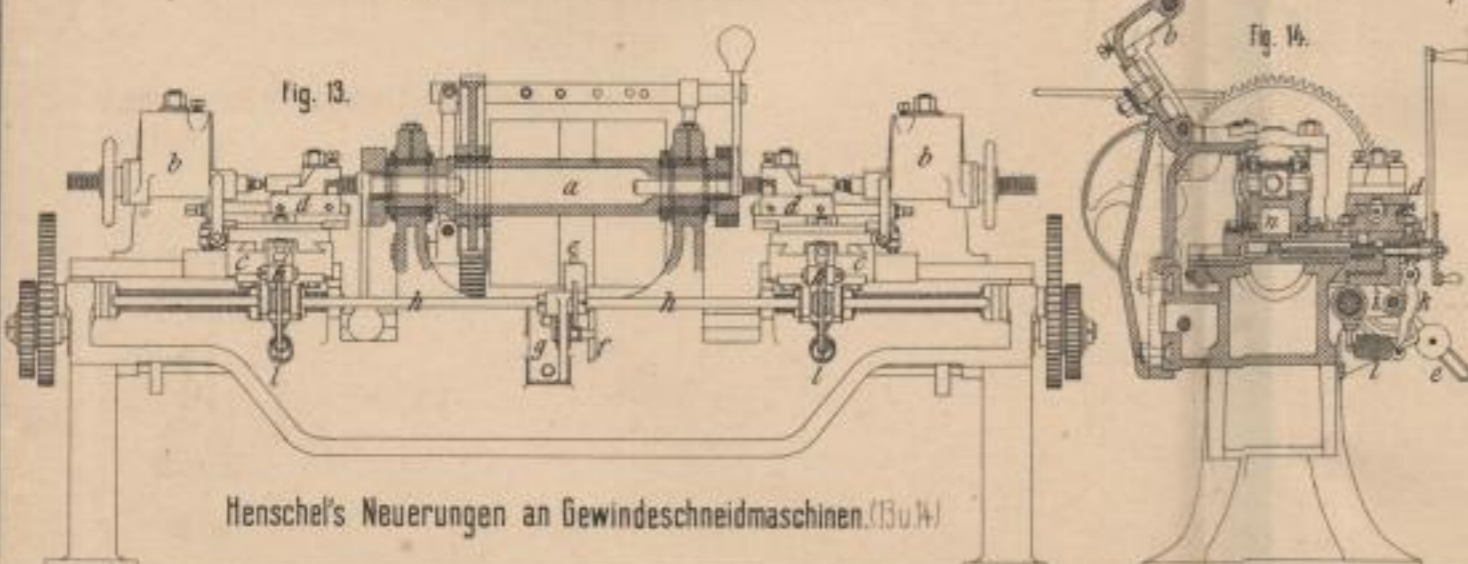

Lith. Anst. v. J. Nees, Jarmutaal.

E. Gessner's Rauhaschinen. (1-7)

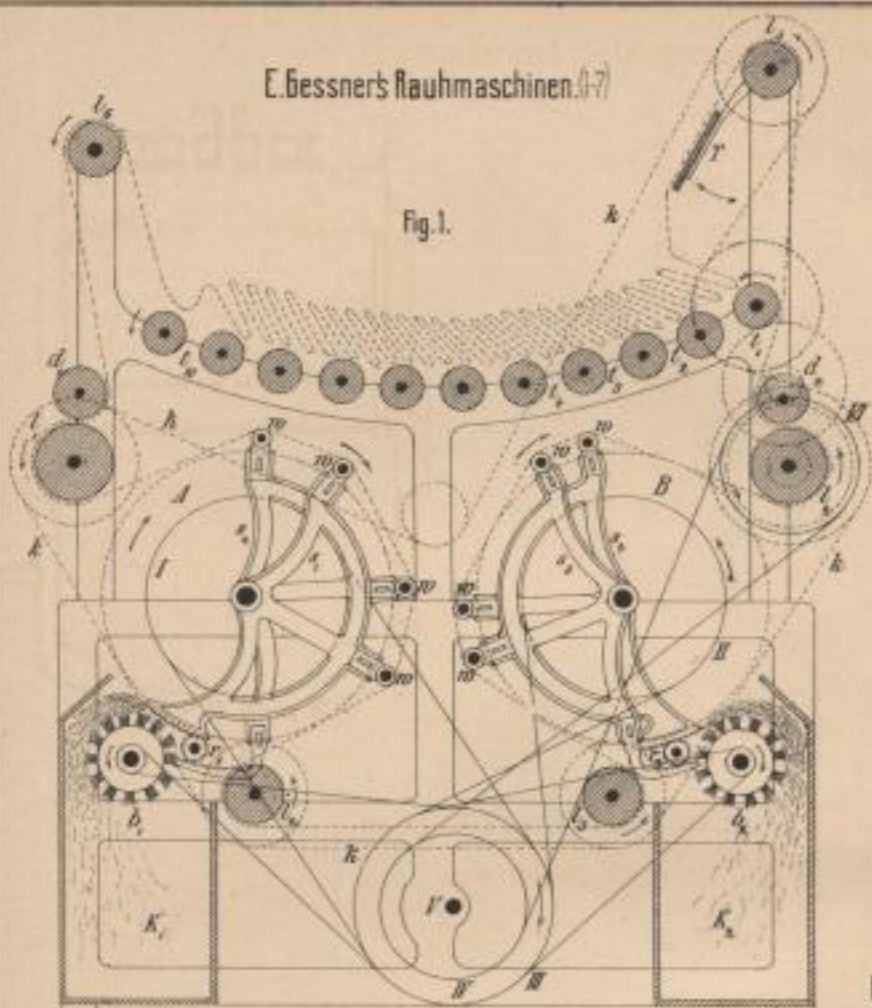

Albey's Siebführer (9 u 10)

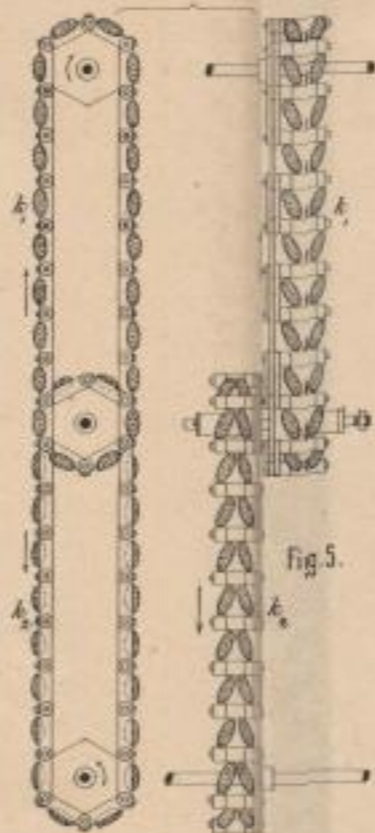

Bröner's Reinigungsapparat für Anthrochinon o. dgl. (11)

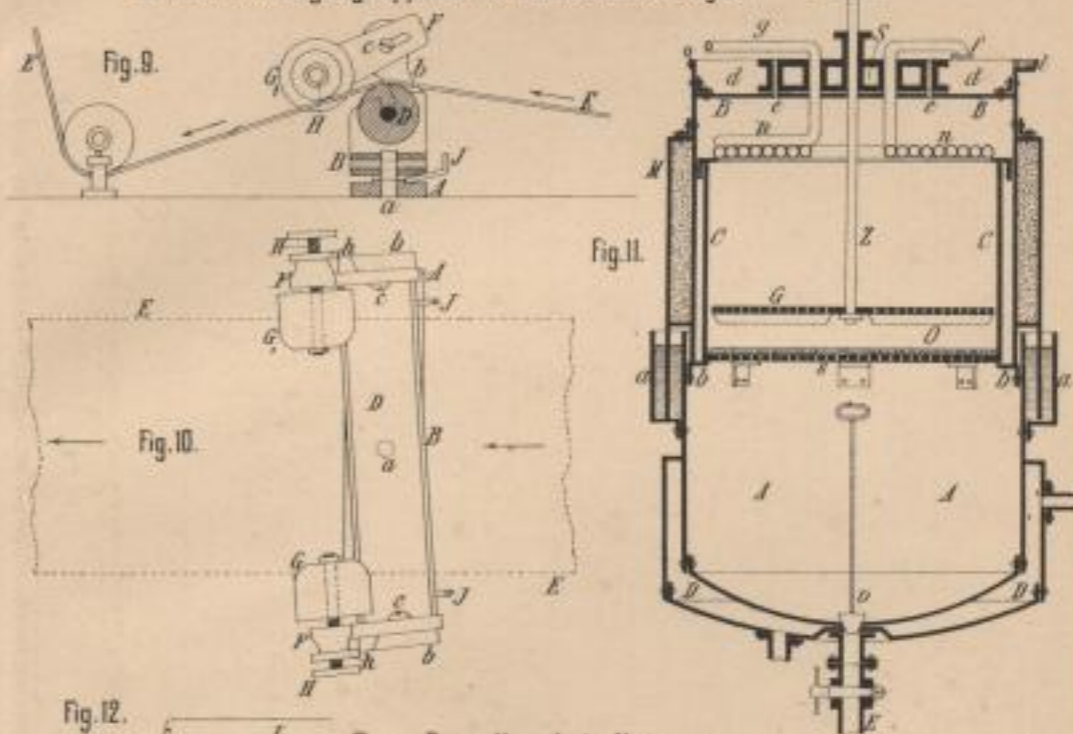

O. König und E. Esser's Postiraparat. (16)

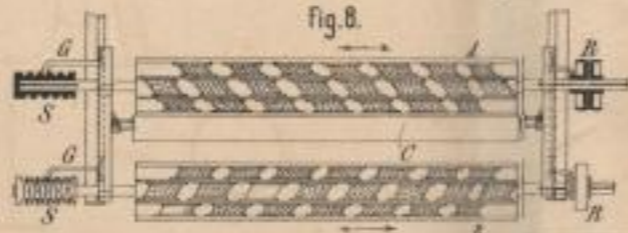
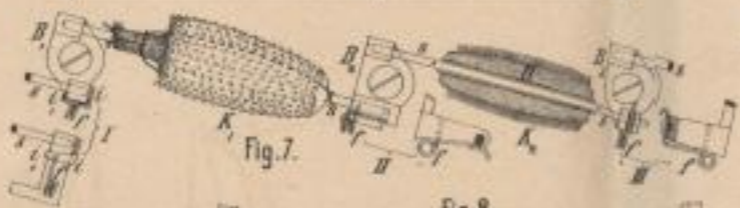
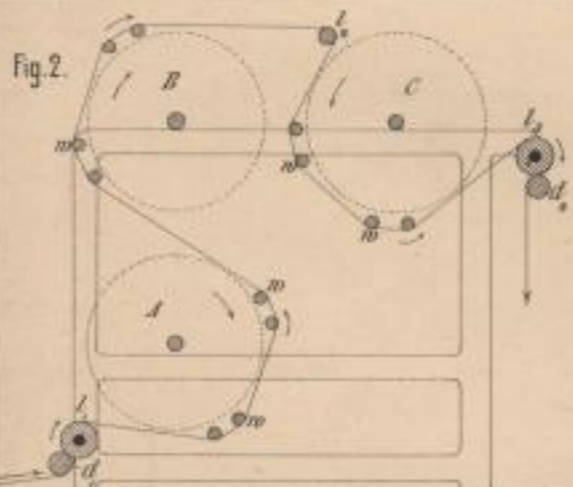

E. van Rysselberghe's Neuerung im Telegraphenbetriebe. (12-16)

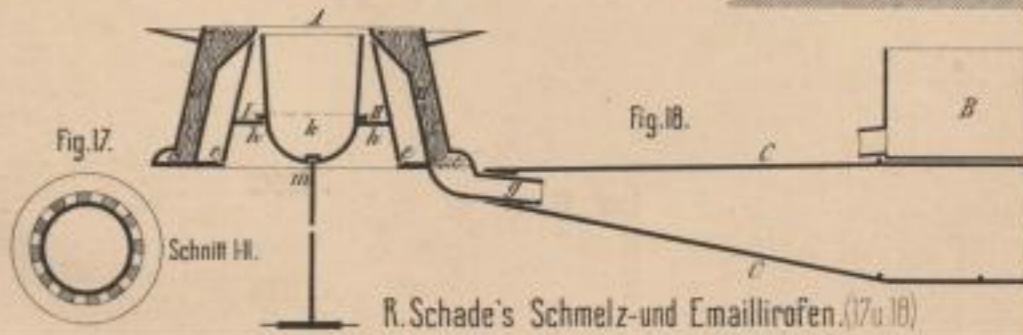
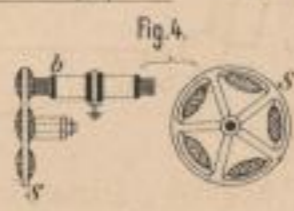
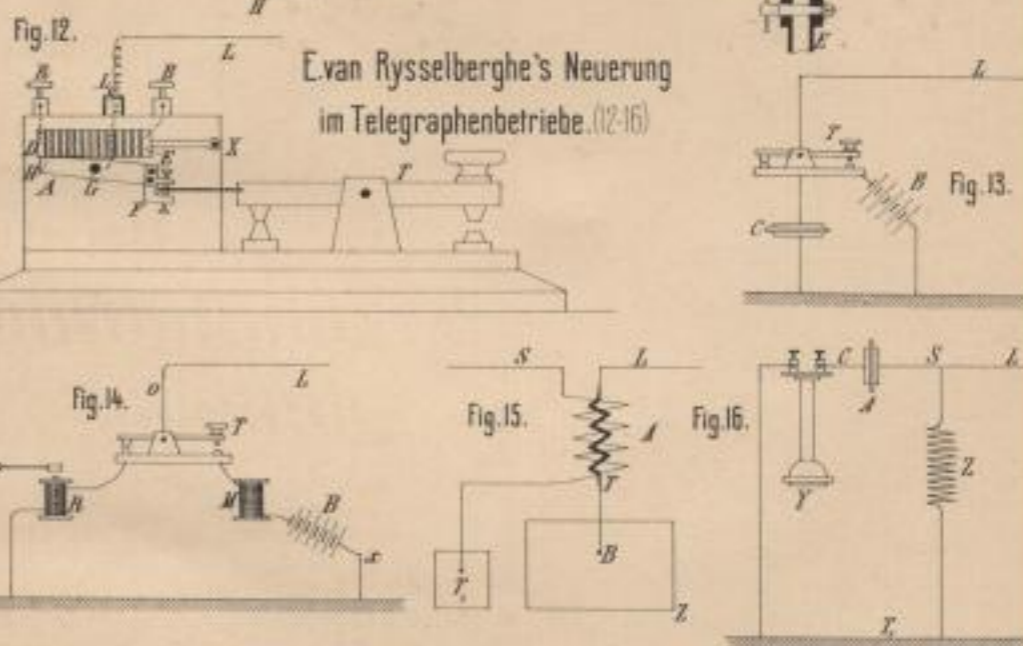

Lith. Anst. v. J. Nebe, Darmstadt

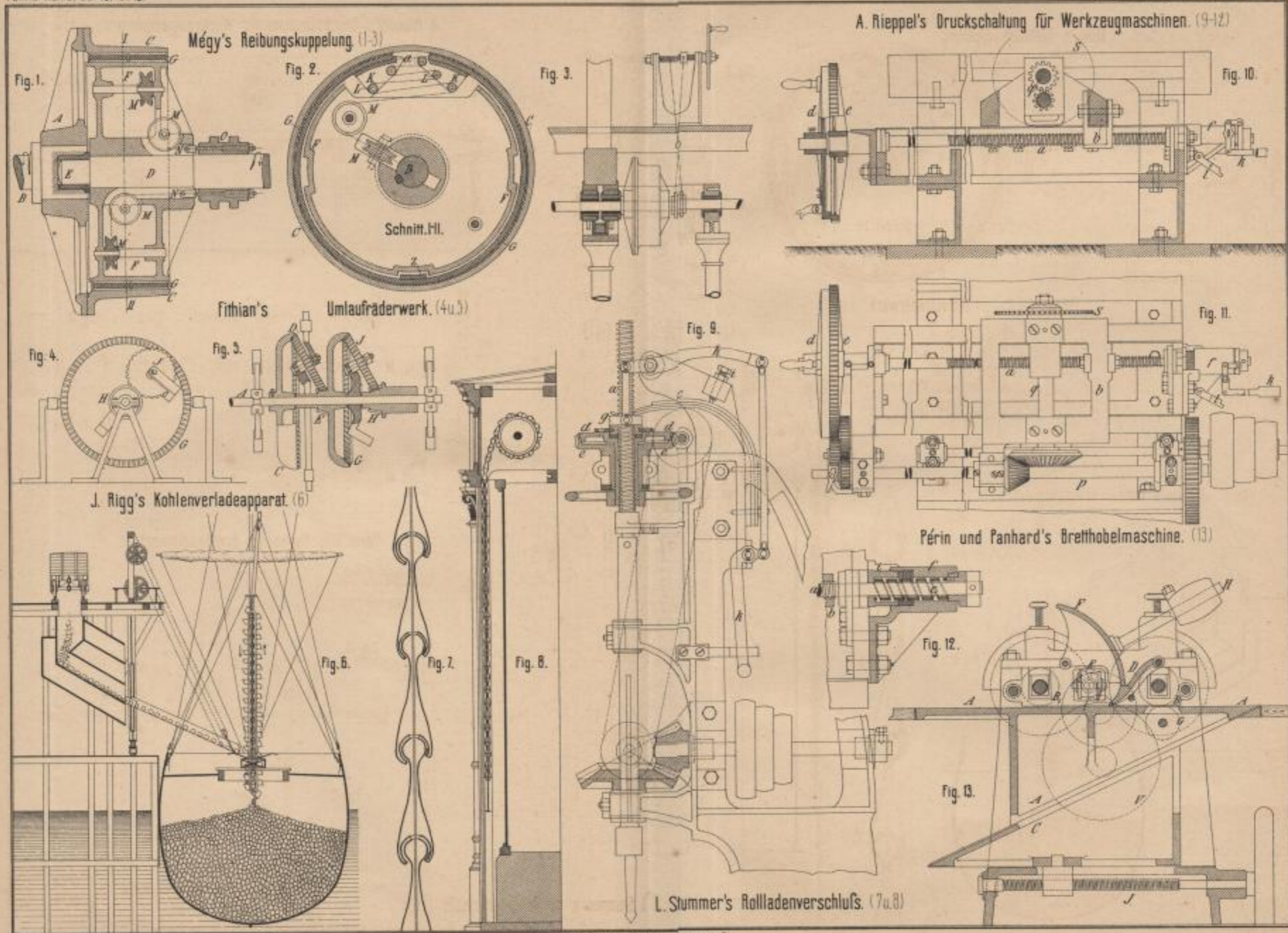

Lith. Anst. v. J. Nebe, Darmstadt.

Pictet's Herstellung von Schwefelsäureanhydrid. (1)

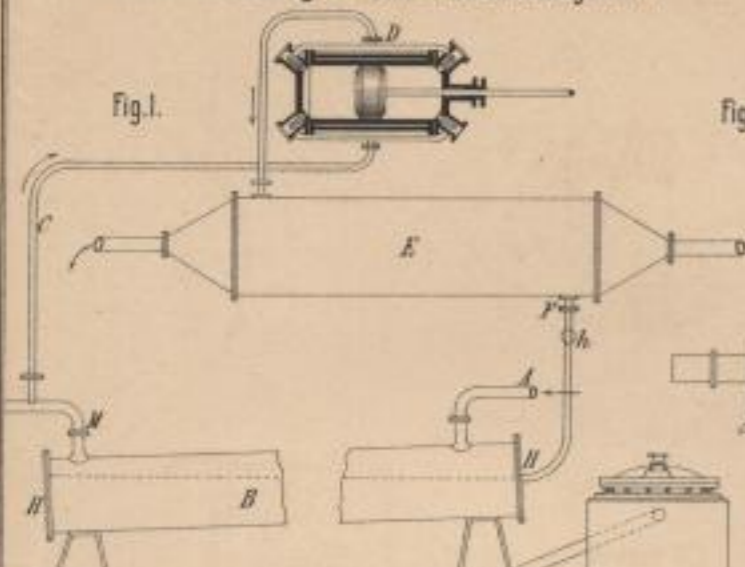

Fig. 1.

Abdank. (8 u 9)

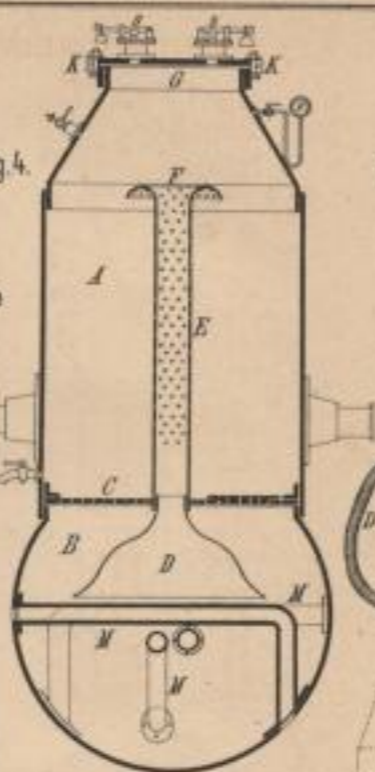

Fig. 4.

Neuerungen an elektrischen Bogenlampen. (8-13) E. Bürgin. (10 u 11)

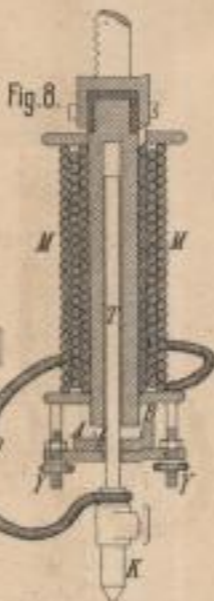

Fig. 8.

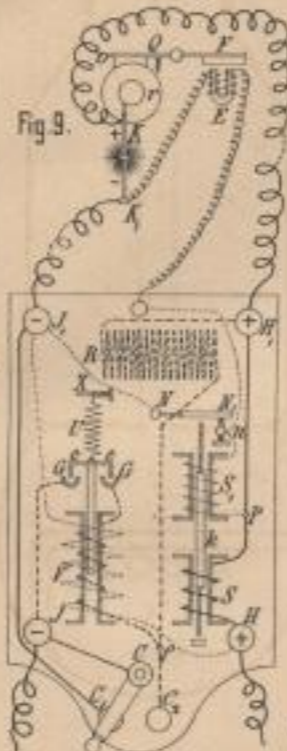

Fig. 9.

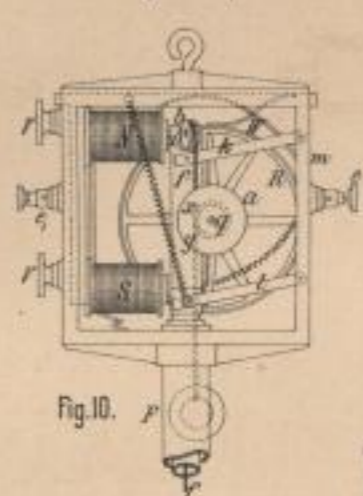

Fig. 10.

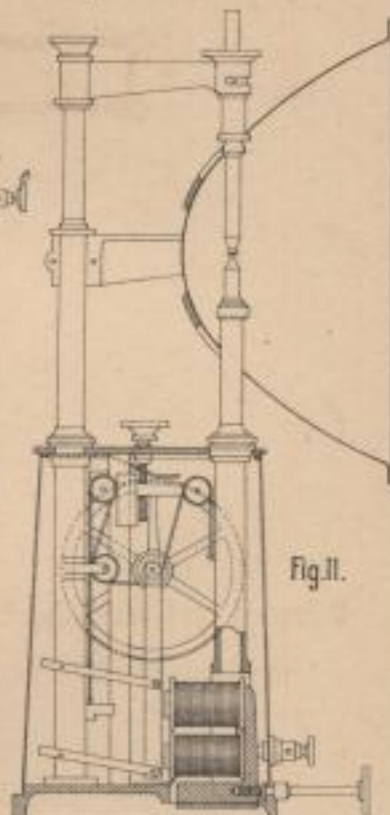

Fig. 11.

M. Dresel's bez. F. Baumann's Herstellung von Holzzellstoff. (2 u 3 bez 4 u 5)

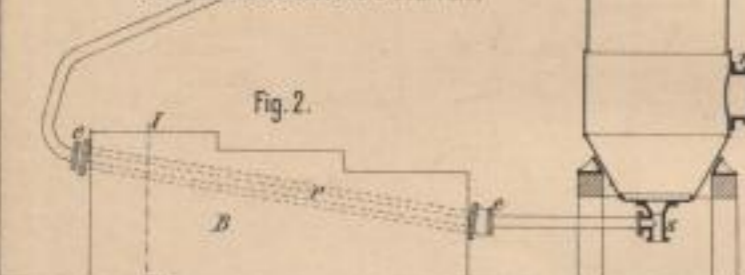

Fig. 2.

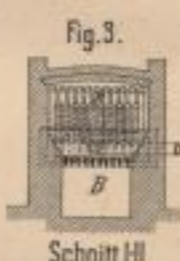

Fig. 3.

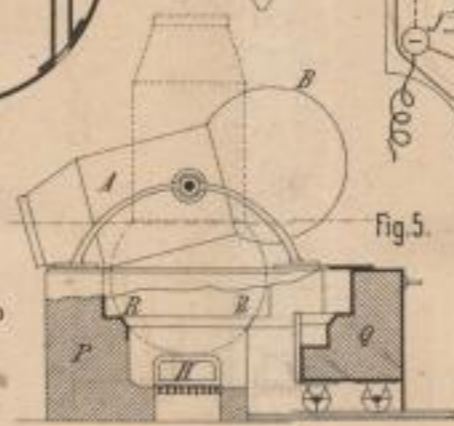

Fig. 5.

C. O. Haskins. (12)

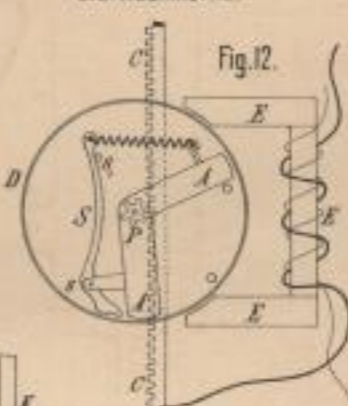

Fig. 12.

P. Weißgerber. (16)

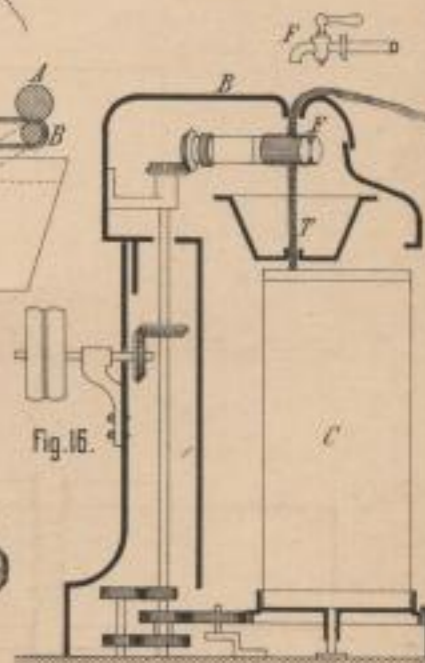
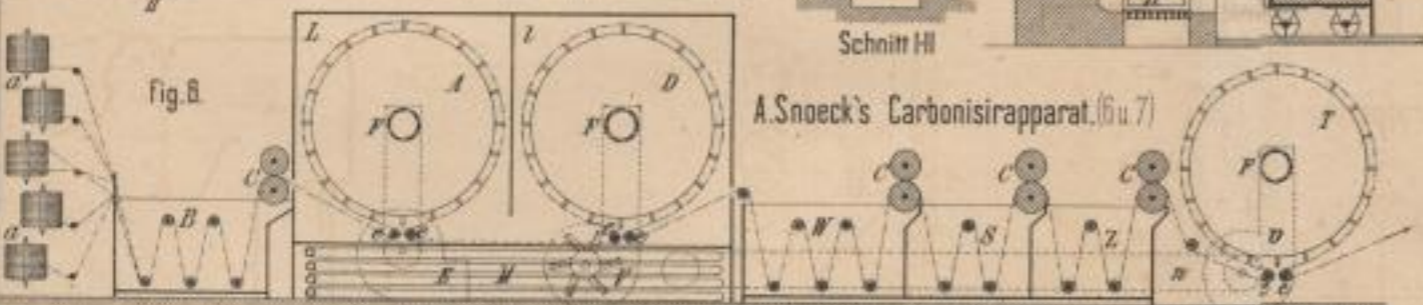

Fig. 16.

A. Snoeck's Carbonisirapparat. (6 u 7)



Schnitt III

Fig. 13.

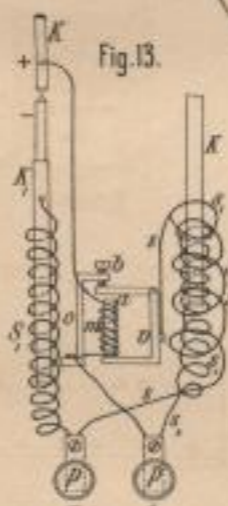

Fig. 13.

Fig. 14.

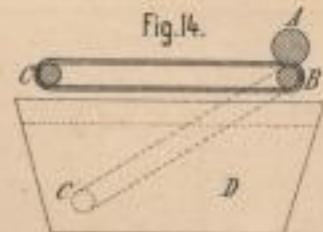

Fig. 14.

H. Anthoni. (14 u 15)

C. P. Jürgensen. (13)

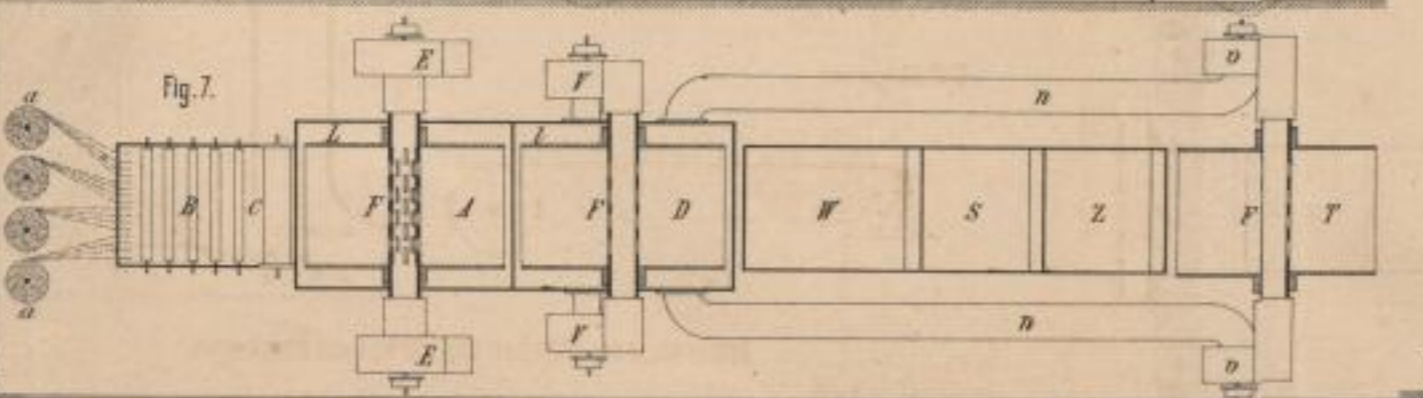

Fig. 7.

Fig. 15.

Apparate zum Bleichen und Färben von Baumwolle. (14-16)

Lith. Aus v. F. Wirtz. Jarmatuch.



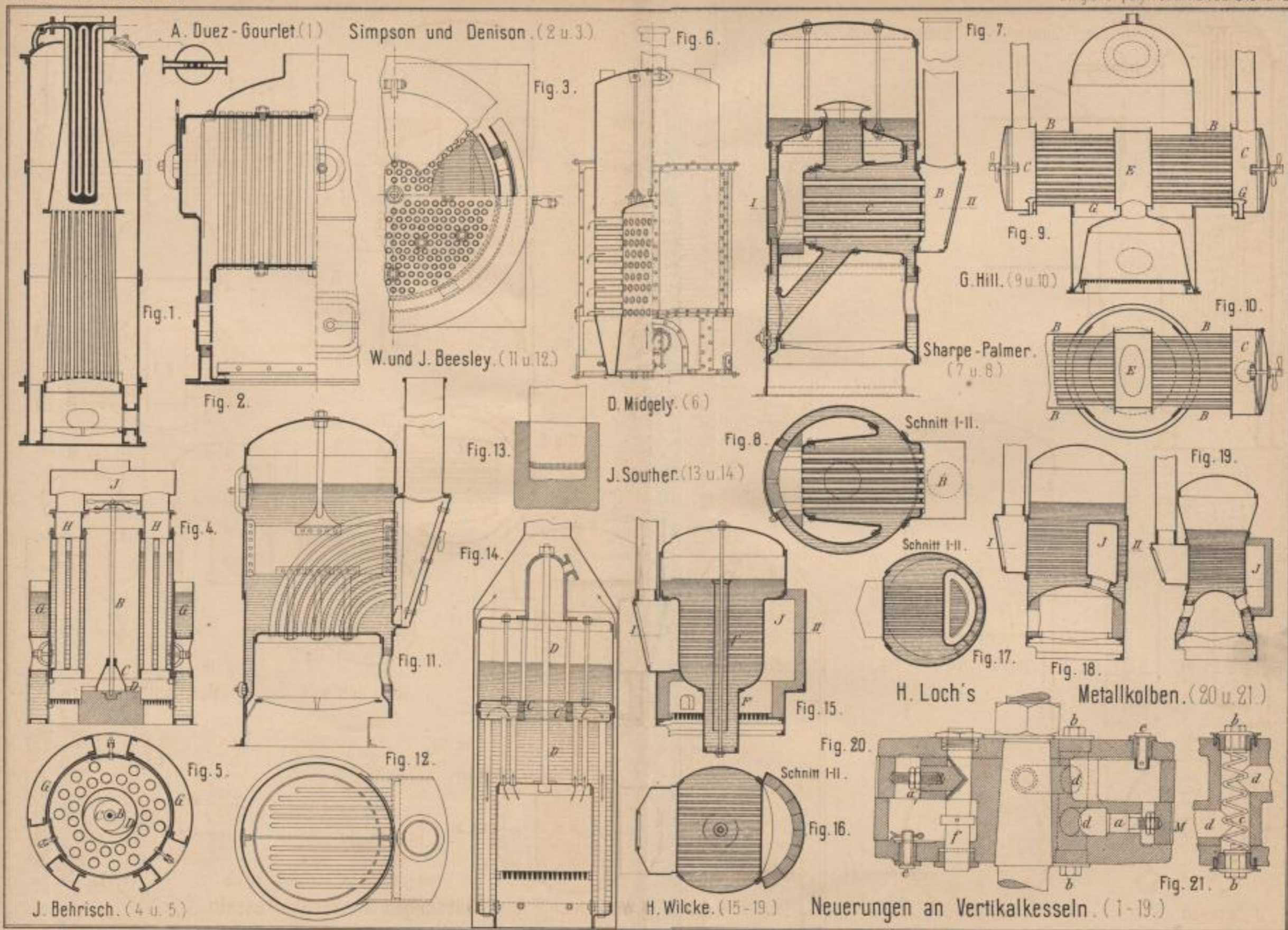

Lith. Anst. v. P. Wenz, Darmstadt.

A. Schwartz's bez. K. Trobach's Spannfutter. (3-8)

Galbraith's Befestigung lose gewordener Radreifen. (9-12)

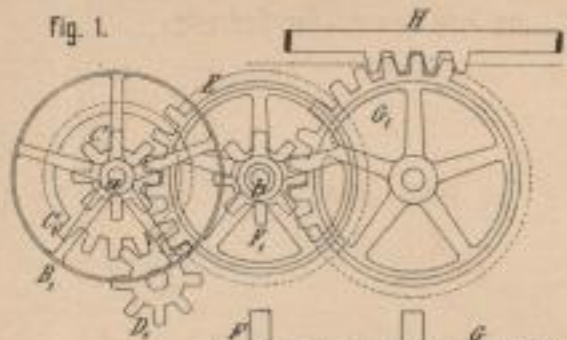

Fig. 3.

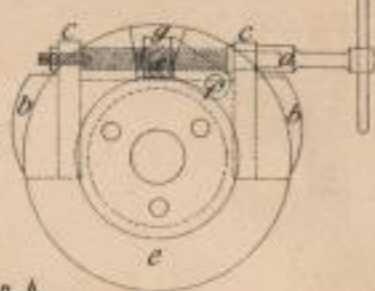

Fig. 7.

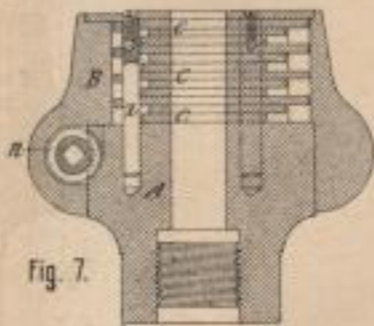

Fig. 8.

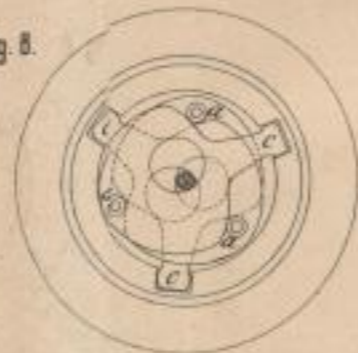

Fig. 9.



Fig. 10.



Fig. 11.



Fig. 12.



Kirchhof's Schachthürverschlufs. (19 u. 20)

Fig. 19.

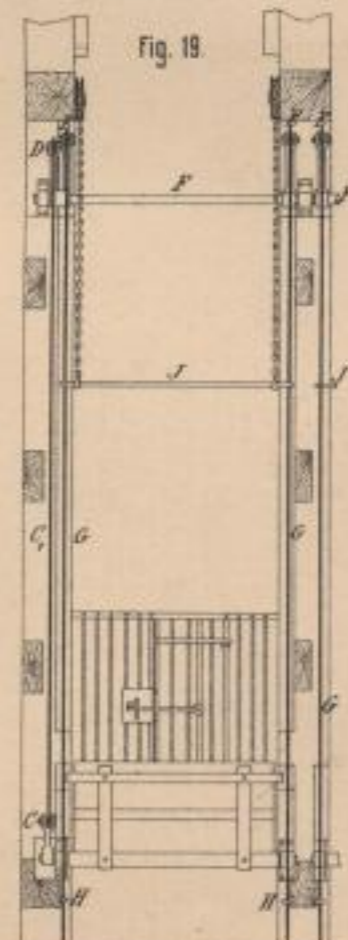
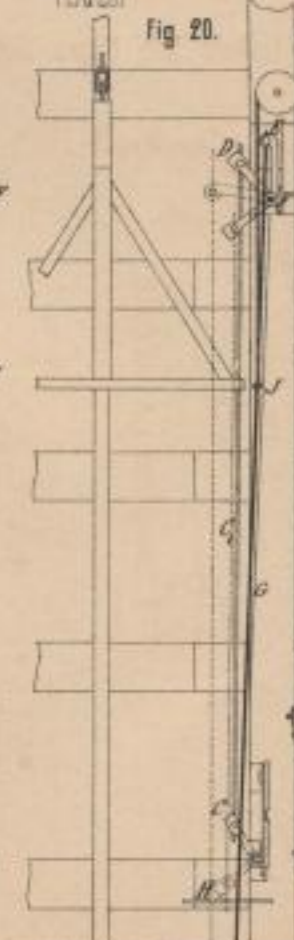
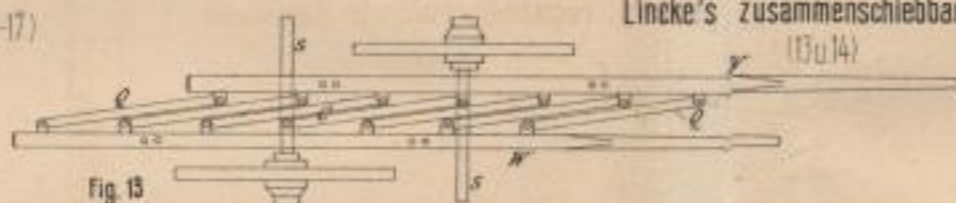

Fig. 20.



Lincke's zusammenschiebbarer Handwagen. (13 u. 14)

Fig. 13.



G. F. Redfern's Drillbohrer. (16)

Fig. 18.

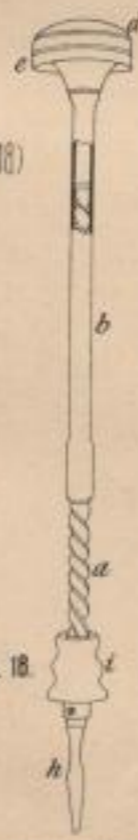
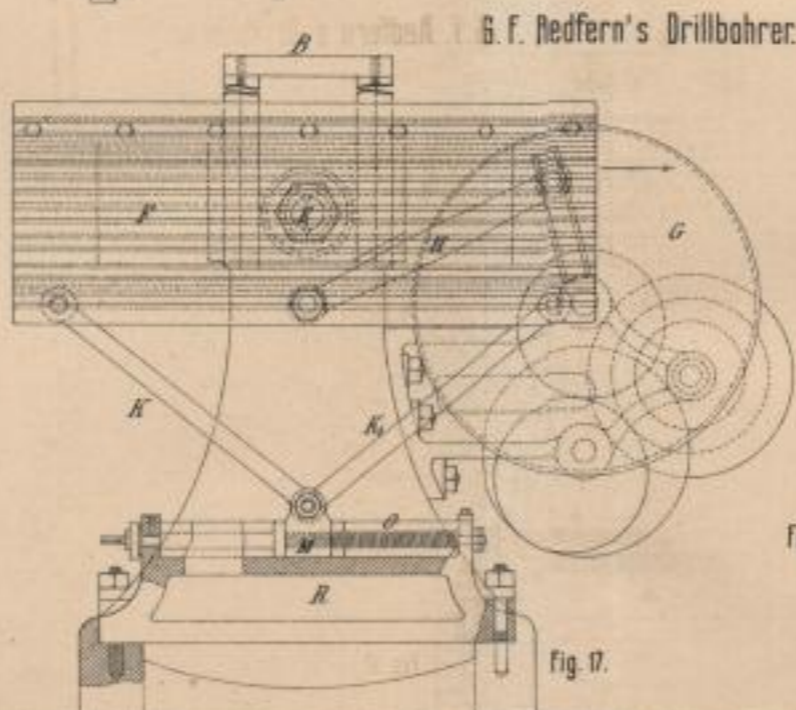

Fig. 17.



Bilgram's Zahnstangen-antrieb für Hobelmaschinen. (1 u. 2)

Fig. 2.

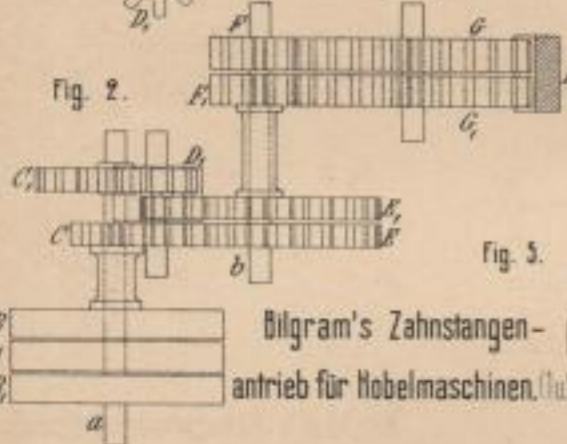

Fig. 5.

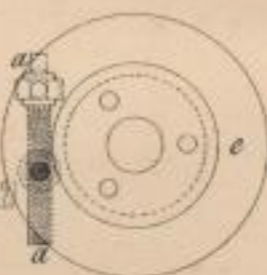

Fig. 6.



Finke's Kreisbögen-Hobelmaschine. (15-17)

Fig. 15.

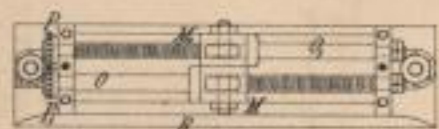
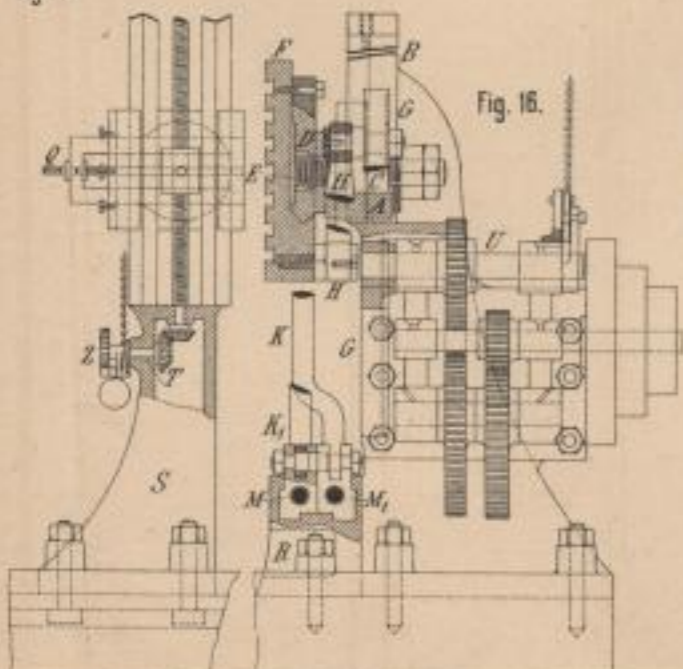

Fig. 16.



Lith. Anst. v. F. Weber, Darmstadt

Ueber die Herstellung von Glas. (Taf. 23)

E. H. Siebert. (1-3)

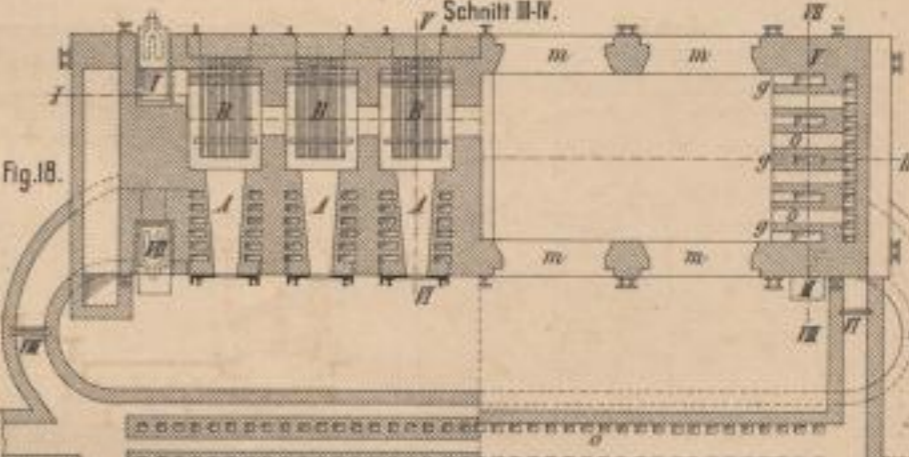
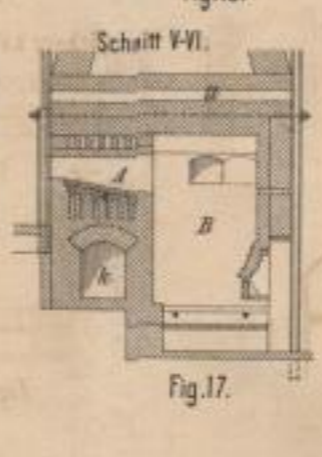
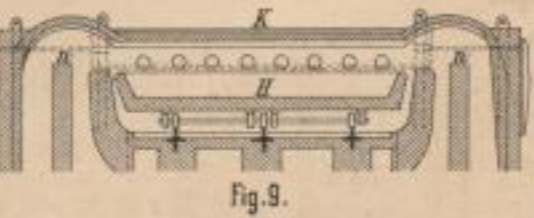
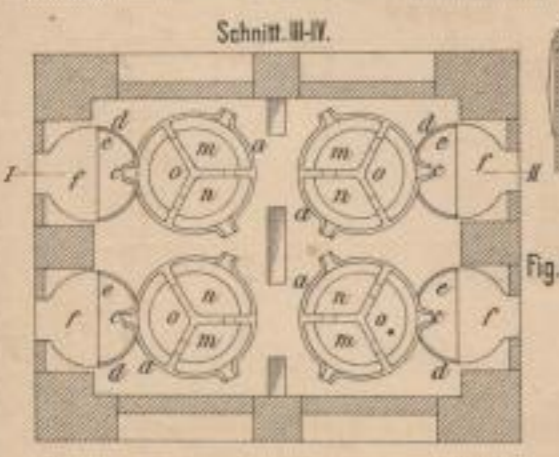
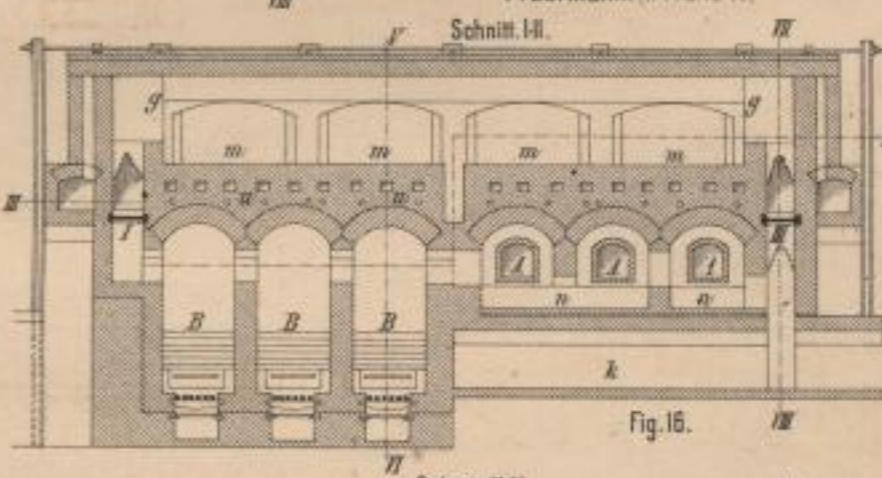
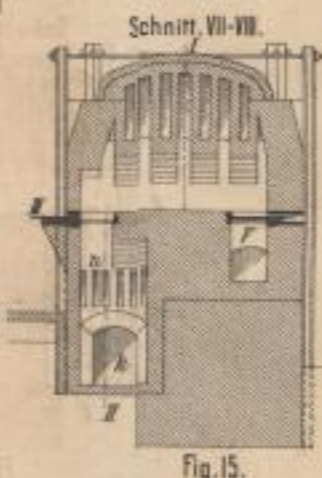
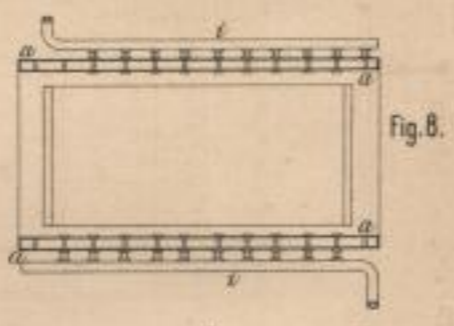
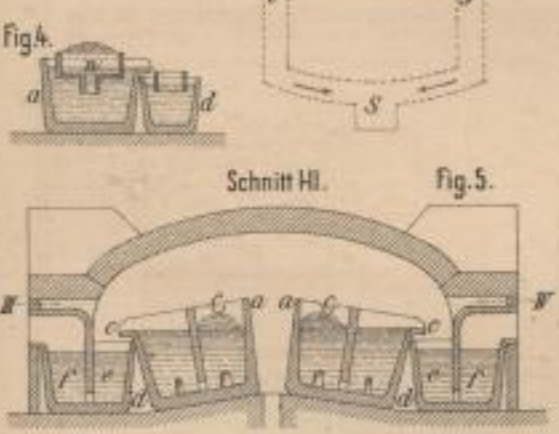
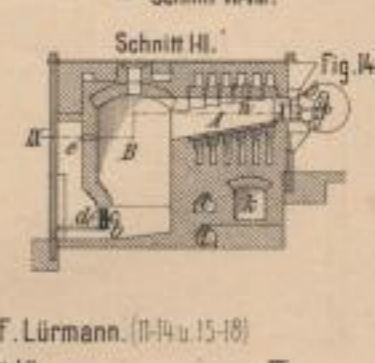
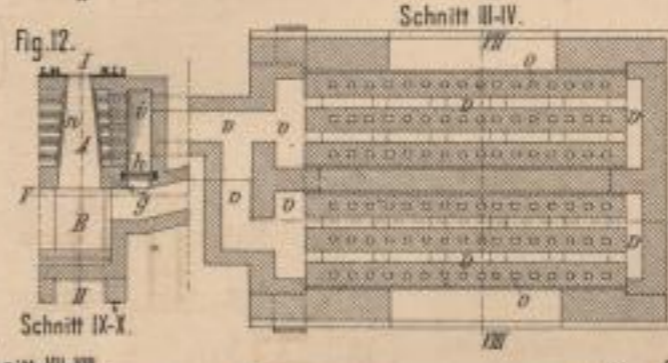
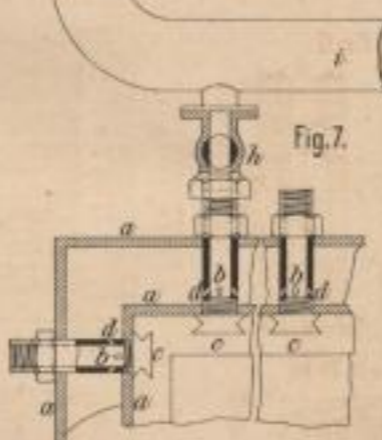
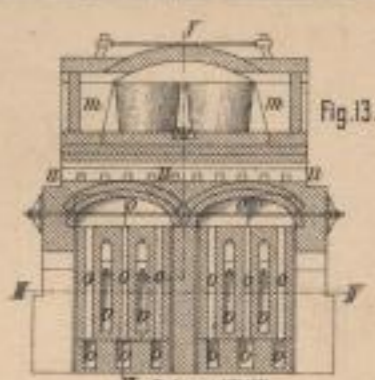
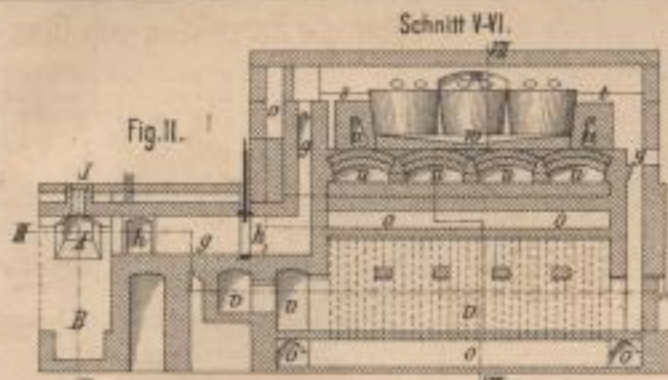
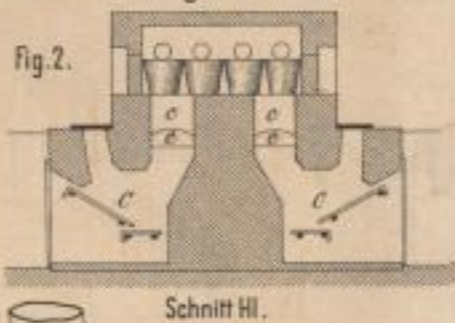
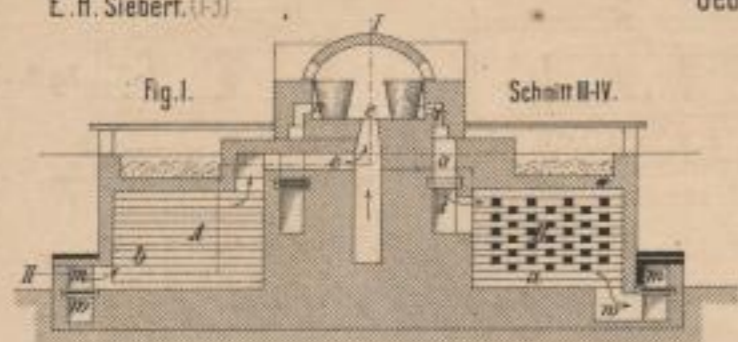

F. Lürmann. (11-14 u. 15-18)

C. Nehse und F.O. Hirsch. (4-6)

Ch. A. W. Schön. (7 u. 8, 9 u. 10)

Lehr. Anst. u. P. Werk. Darmstadt.

Neuerungen an Vertikalkesseln. (Taf. 21 u. 24)

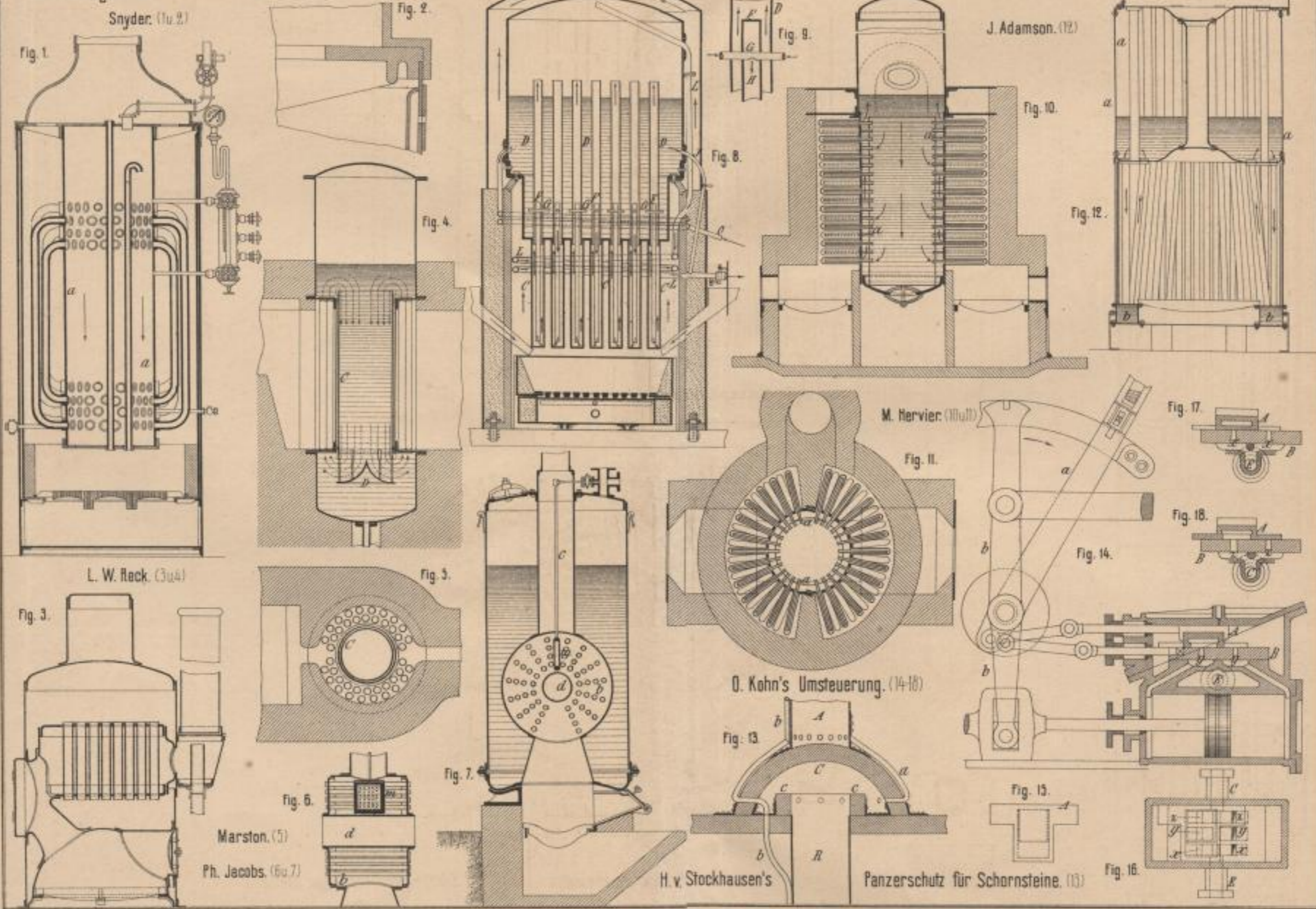

Lith. Anst. v. F. W. W. Darmstadt

Neuerungen an Verdampfapparaten. (1-7, 14 u. 15)

B. Borowsky's Herstellung von Bernsteinlack. (8 u. 9)

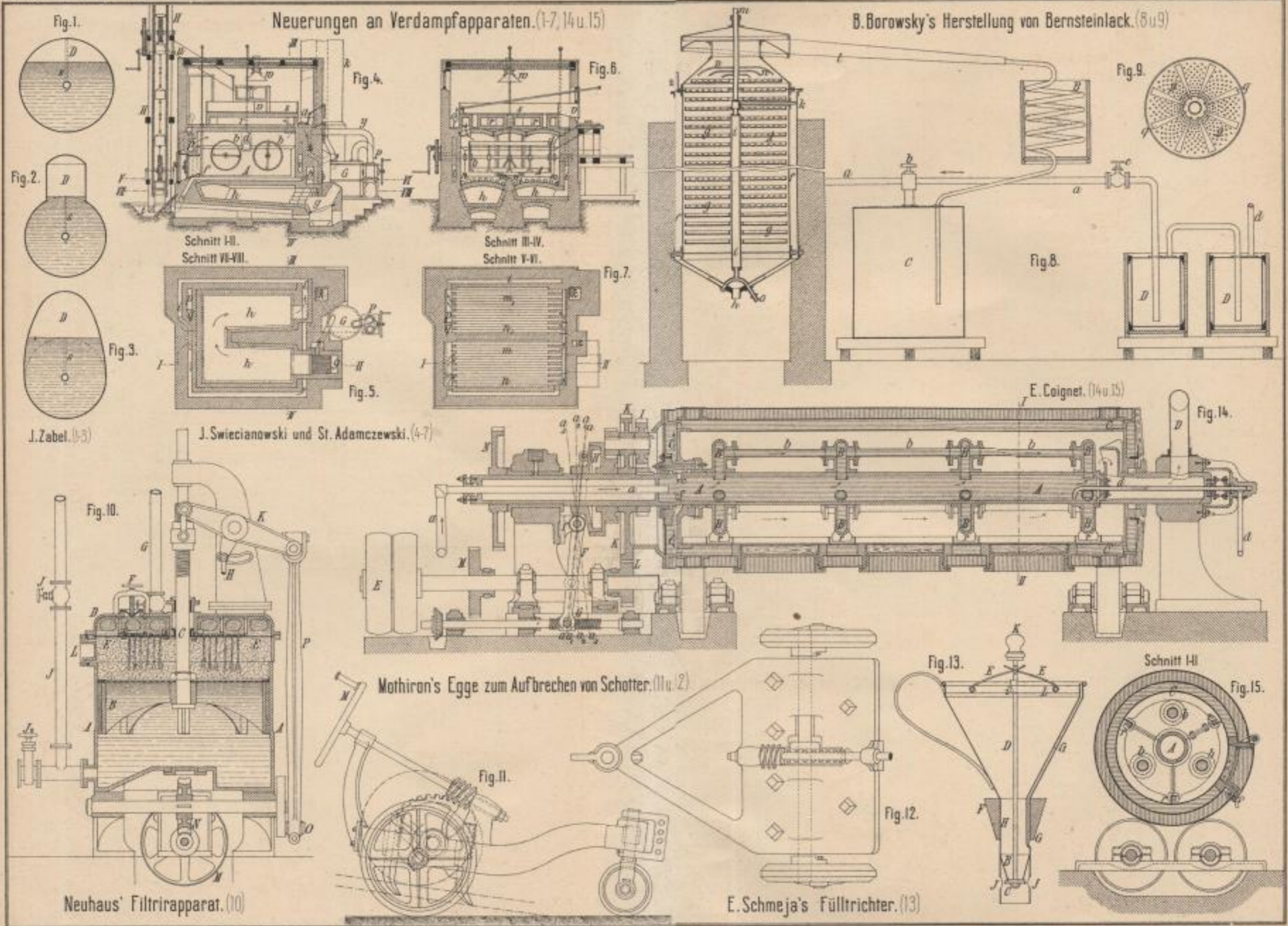

J. Zabel. (1-3)

J. Swiecianowski und St. Adamczewski. (4-7)

E. Coignet. (14 u. 15)

Mothiron's Egge zum Aufbrechen von Schotter. (11 u. 2)

E. Schmeja's Fülltrichter. (13)

Neuhaus' Filtrirapparat. (10)

Lith. Aut. v. F. W. B. Bernstadt.

W. M. Jackson. (1)

E. Fischer: Über Verwendung von Leuchtgas zur Wärmeentwicklung. (Taf. 26)

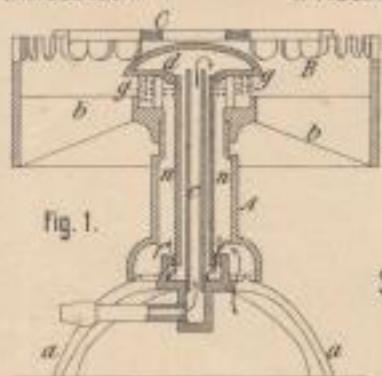

Fig. 1.

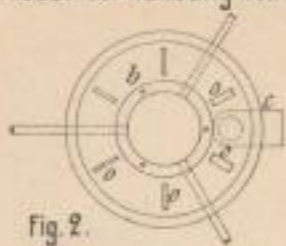

Fig. 2.

Schulz und Sackur. (2 u 3)

W. H. Mielck. (4)

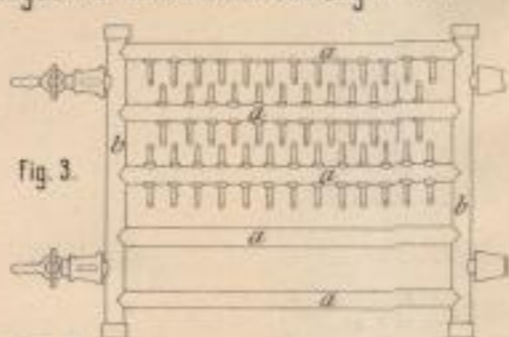

Fig. 3.



Fig. 11.

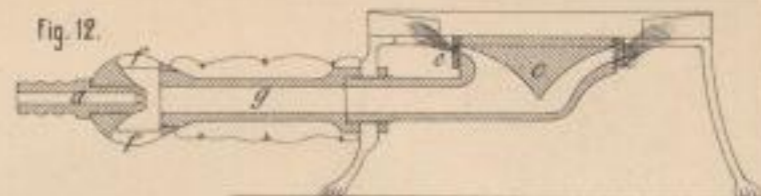

Fig. 12.

G. Wobbe. (11-16)

Fig. 13.



Fig. 14.

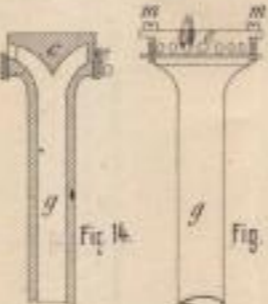

Fig. 15.



Fig. 16.



Fig. 21.



Fig. 22.

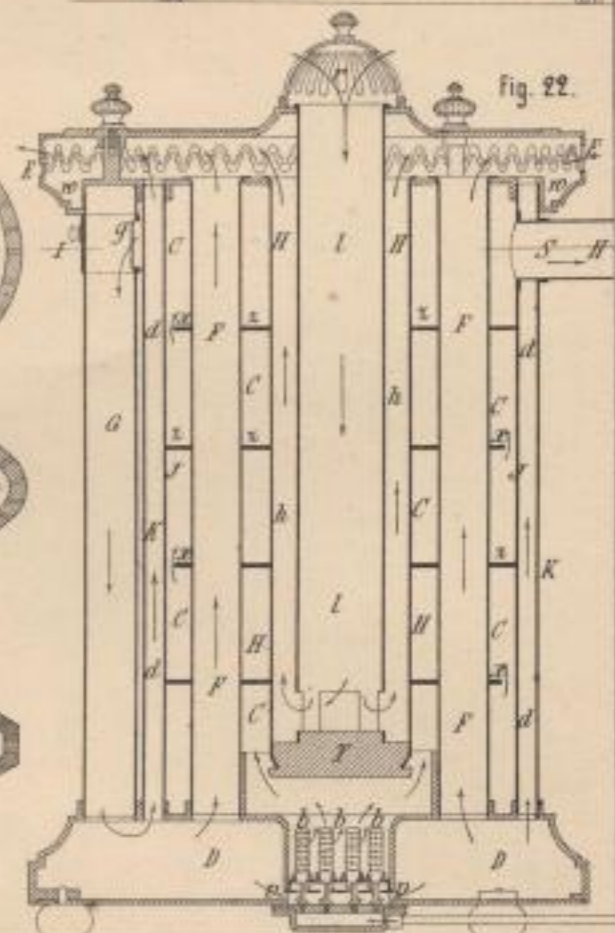

Schnitt III.

J. Cougnet. (5-10)

Fig. 5.

Fig. 6.

Fig. 7.

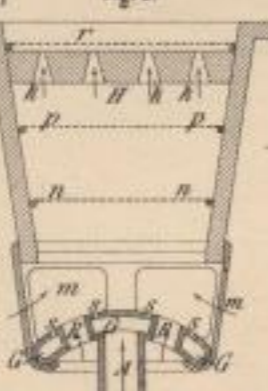
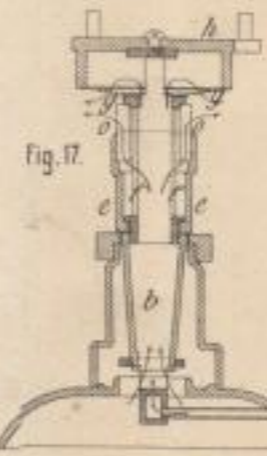

Fig. 8.



Fig. 17.



A. H. Harington. (17)

Fig. 9.



Fig. 10.

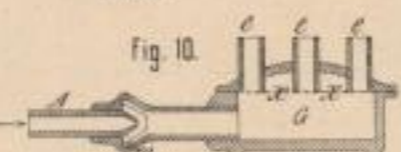

J. Adams. (18-23)

Fig. 18.

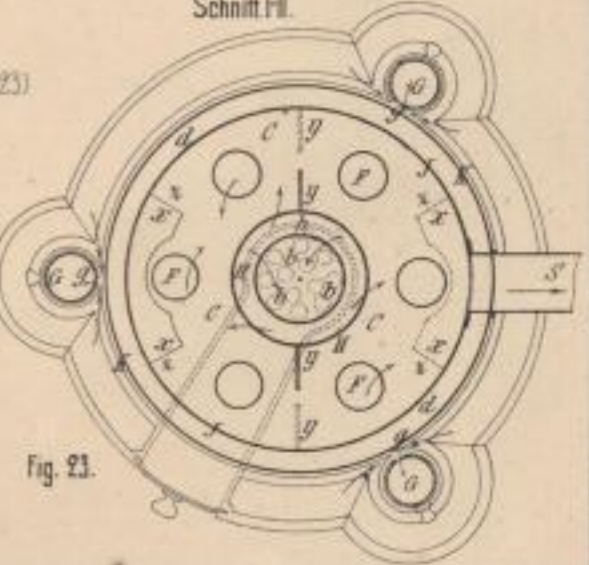
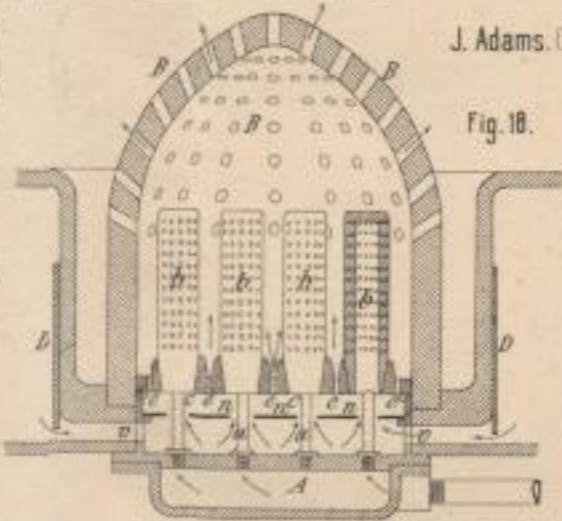

Fig. 23.

Lith. Anst. v. F. P. v. J. v. J. v. J.

G. Robertson's bez. Amos und Smith's Dampfsteuerapparat. (1-4 bez 5)

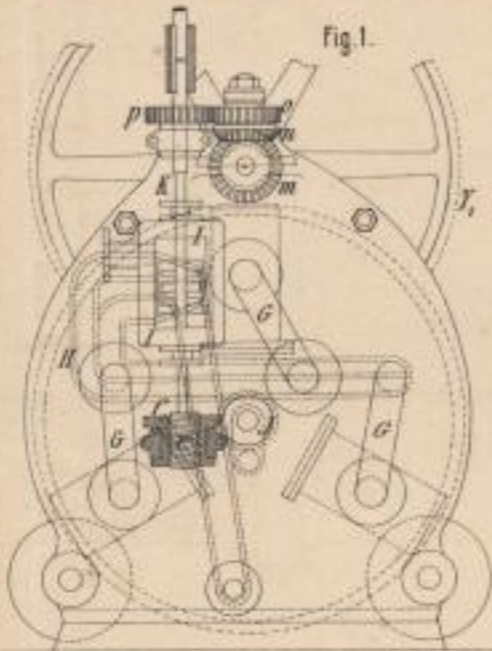

Fig. 1.

Holdingshausen's Lager. (10 u 11) E. de Limon's Riemenscheibe. (14 u 15)

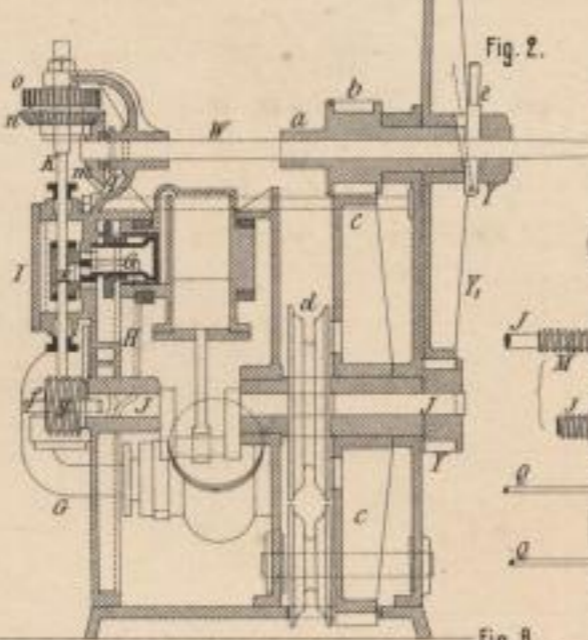

Fig. 2.

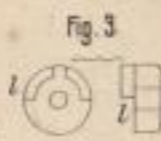

Fig. 3.

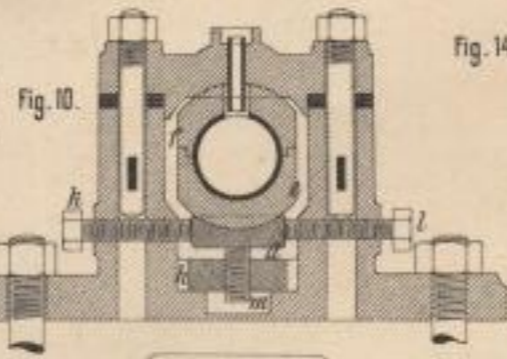

Fig. 10.

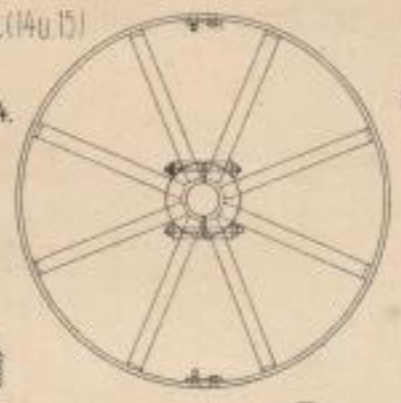

Fig. 14.

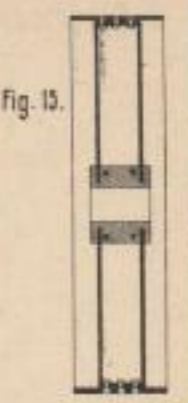

Fig. 15.

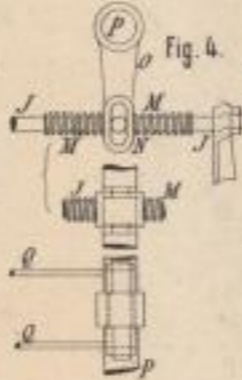

Fig. 4.

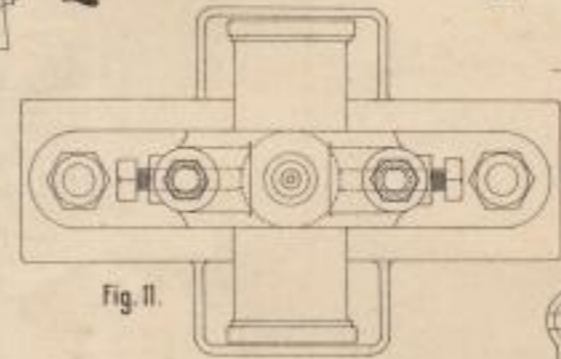

Fig. 11.

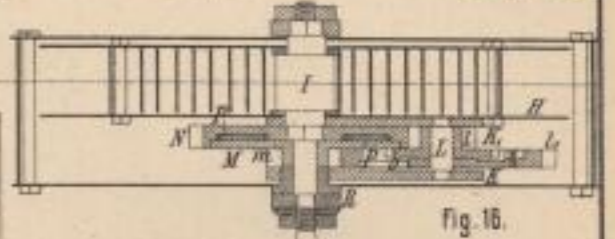

Fig. 16.

Reusch's Gußform für Panzerplatten. (8 u 9)

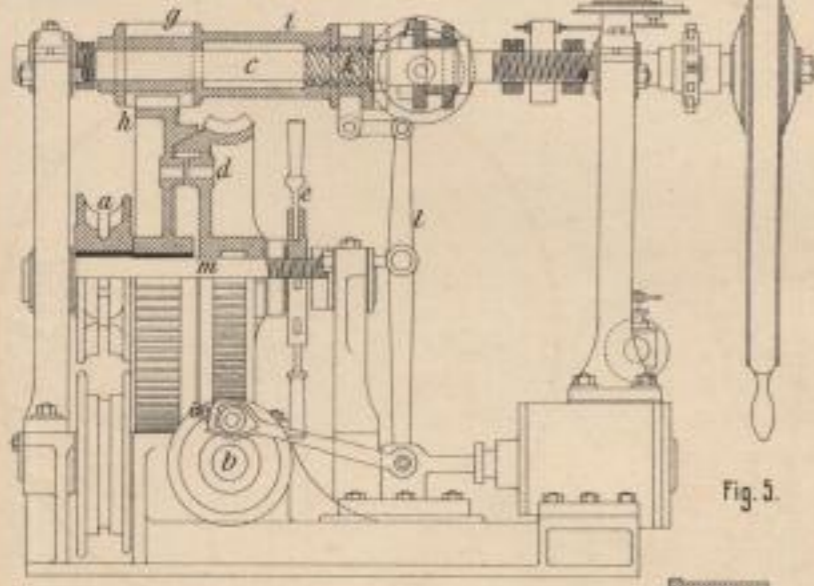

Fig. 5.

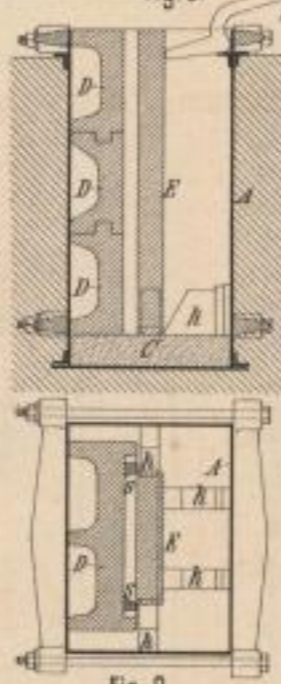

Fig. 8.

Hömann's Rettungsapparat. (16-19)

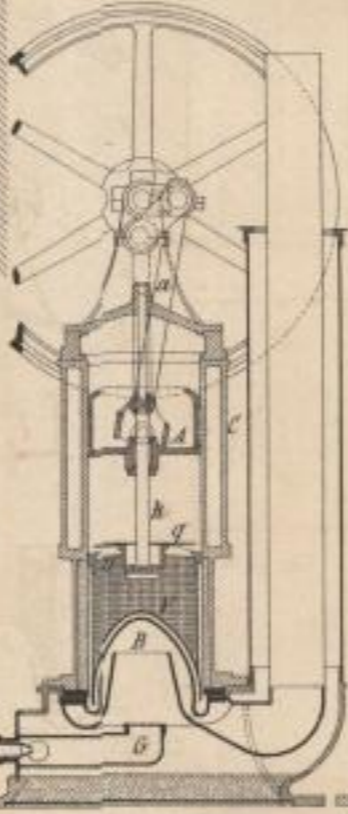

Fig. 12.

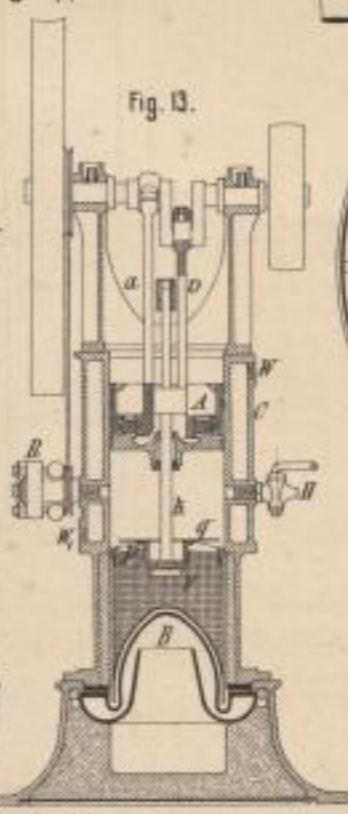

Fig. 13.

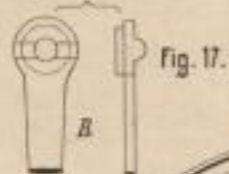

Fig. 17.

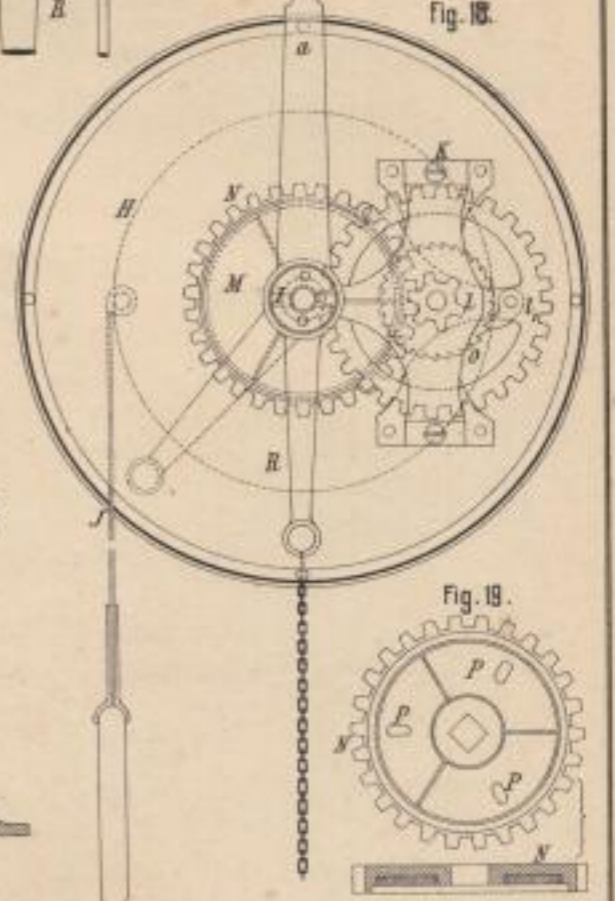

Fig. 18.

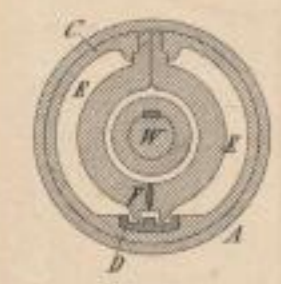

Fig. 6.

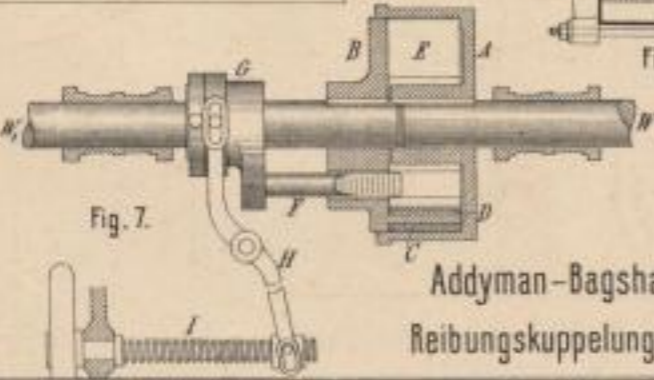

Fig. 7.

Addyman-Bagshaw's Reibungskuppelung. (6 u 7)

A. und H. Robinson's Heißluftmaschine. (12 u 13)

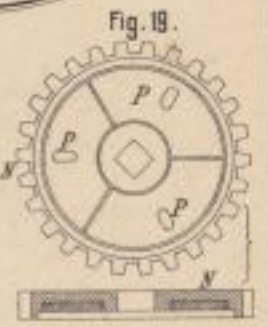

Fig. 19.

Lith. Anst. v. F. Wirtz, Darmstadt.

Neuere Apparate für Photographen.

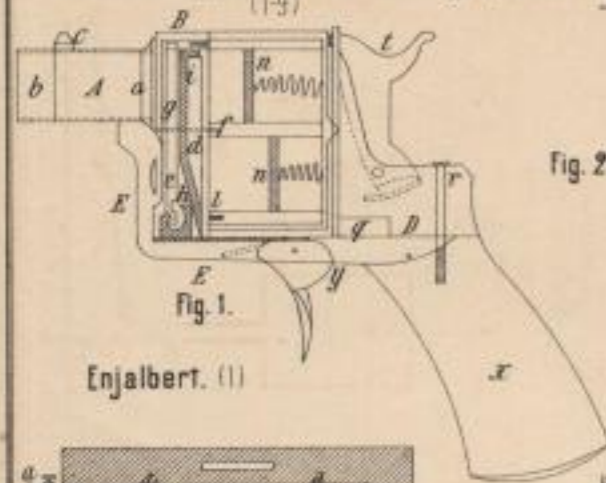
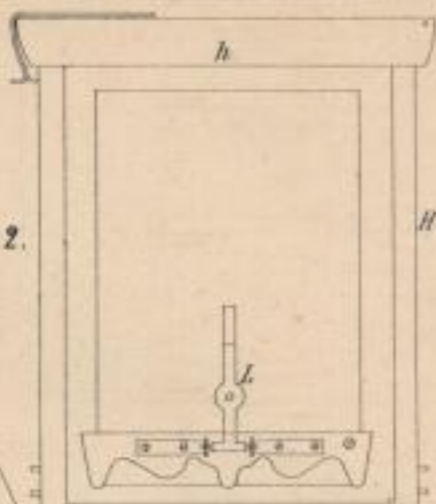

Fig. 2.



Schnitt V-VI.

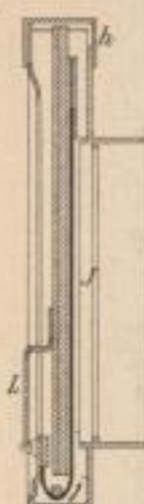

Fig. 3.

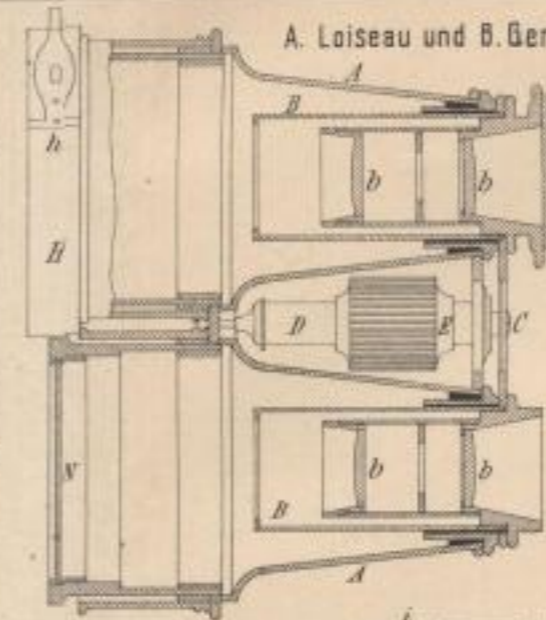

Fig. 4.

A. Loiseau und B. Germeuil-Bonnaud. (2-4)

Fig. 5.

P. Rouaix. (3)

Fig. 6.

Fig. 7.

Braun. (6u.7)

Czerny. (8u.9)

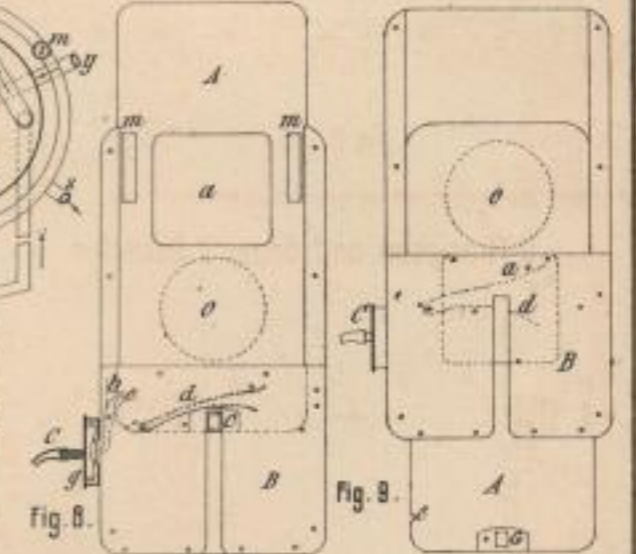

Fig. 8.

Fig. 9.

E. Carey's Herstellung von Natriumbicarbonat. (14-17)

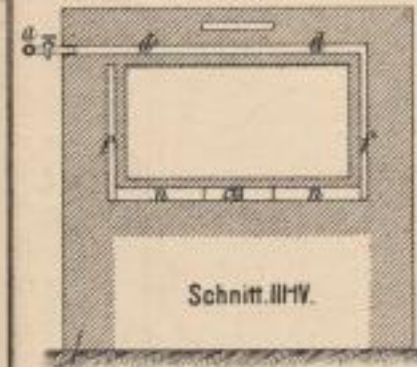

Fig. 10.

Schnitt IIIIV.

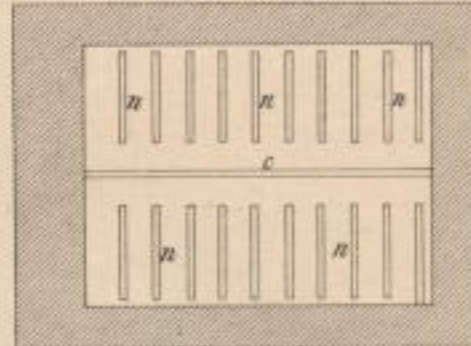

Fig. 12.

Fig. 13.

Fig. 14.

10h. Anst. v. P. Bina. Jena.

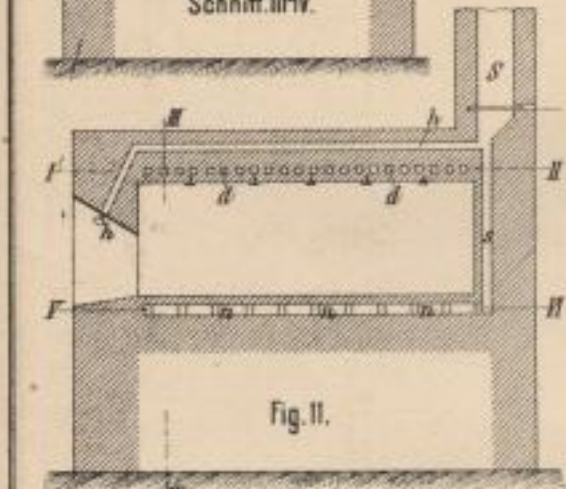
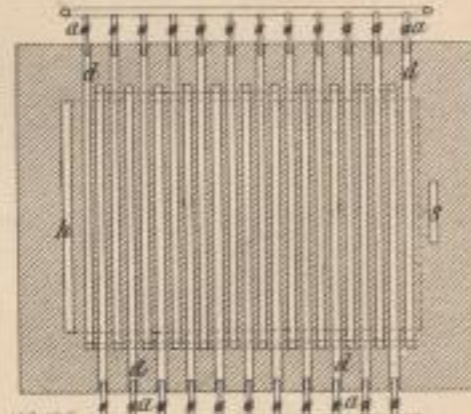

Fig. 11.



Schnitt III.

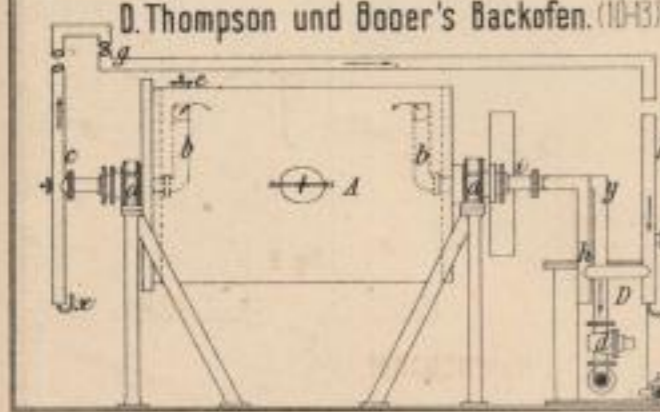

Fig. 14.

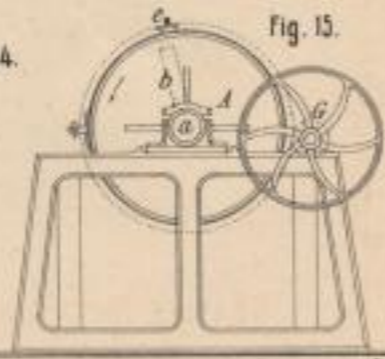

Fig. 15.

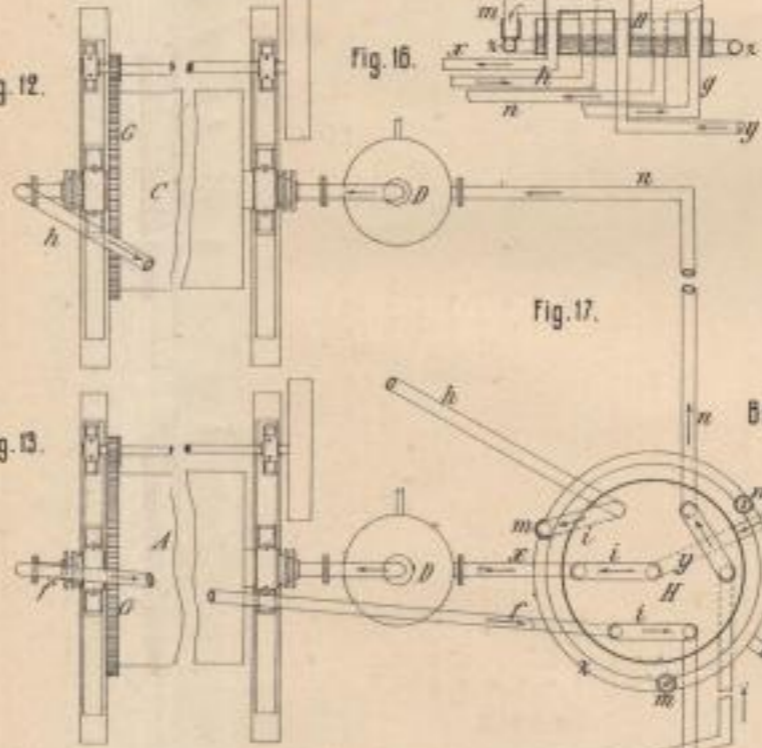
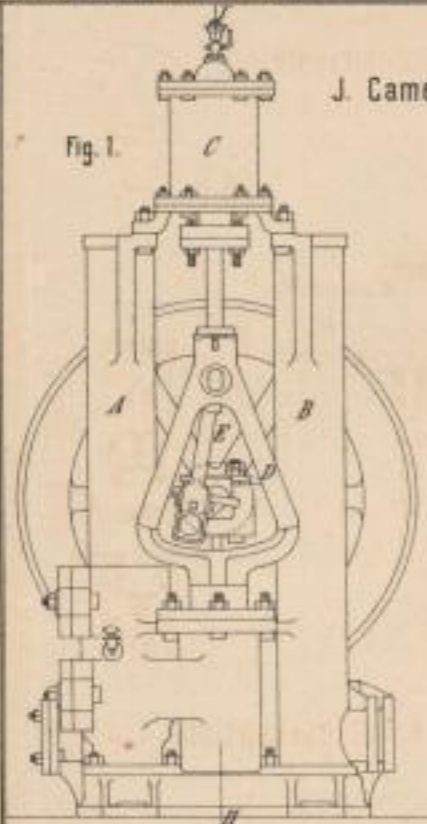

Fig. 16.

Fig. 17.

10h. Anst. v. P. Bina. Jena.

Neuerungen an Pumpen. (1-12)



J. Cameron. (1-3)

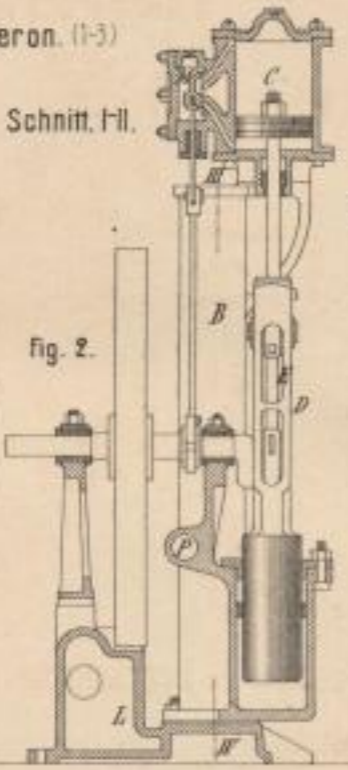

A. Allin und Sohn. (4)

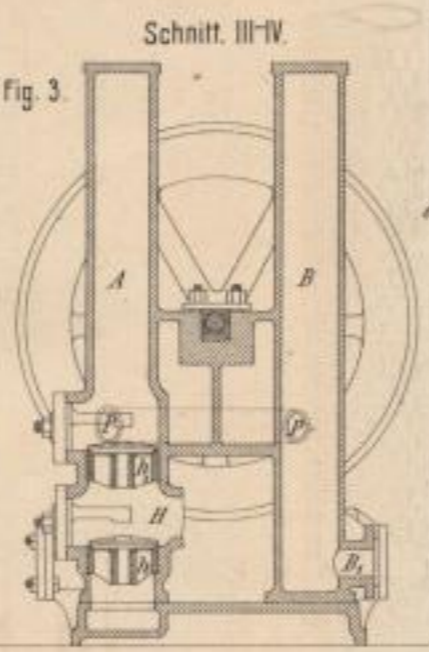

A. Füratsch. (5)

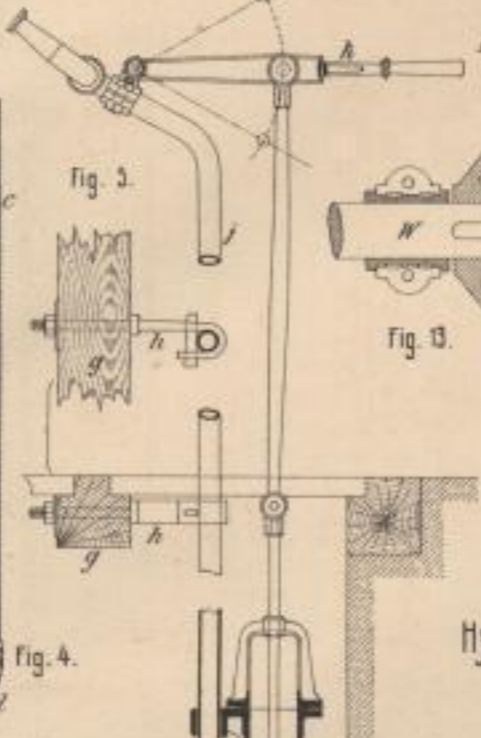

H. Reinhardt's Reducirventil. (13)

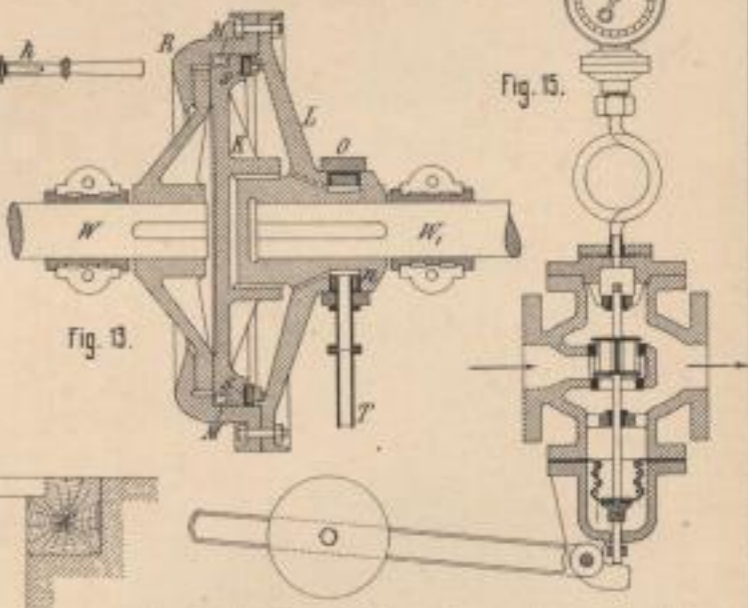

Fig. 13.

Hydraulische Reibungskuppelung. (13 u. 14)

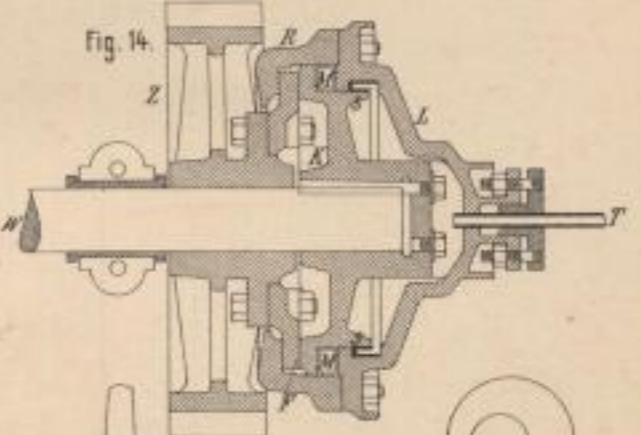

Fig. 14.

A. Schlenk. (6)

Letestu. (7)

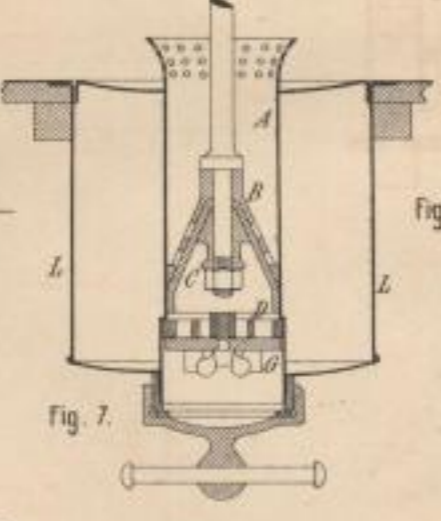
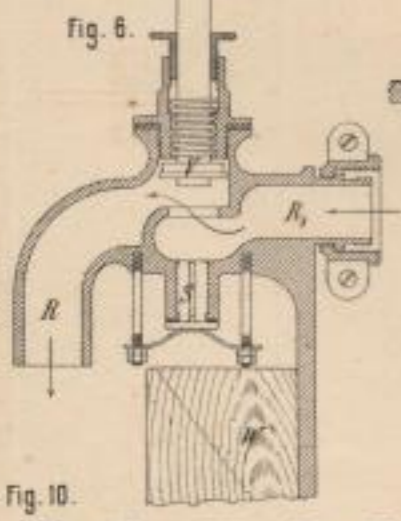

Fig. 8.

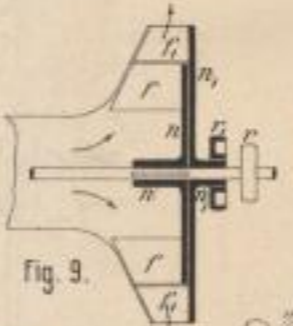

Fig. 9.

C. Megerlin. (10)

A. Petersen. (Bu 9)

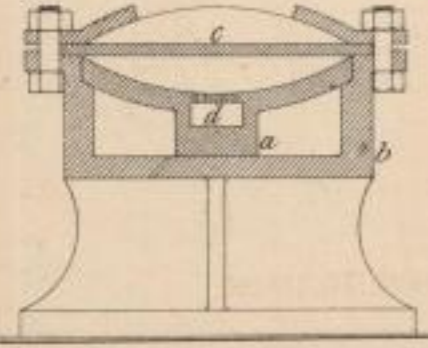

Fig. 10.

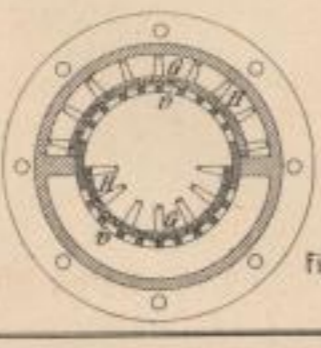

Fig. 11.

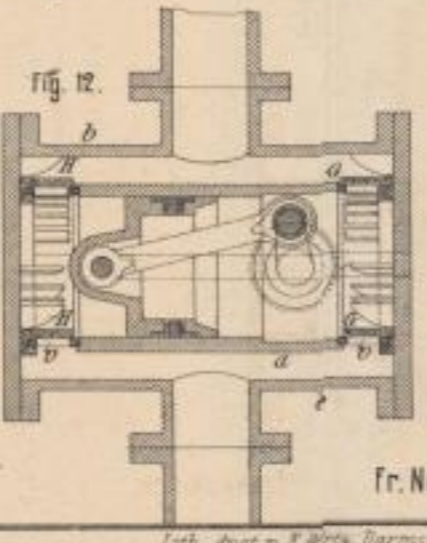

Fig. 12.

Fr. Neukirch. (11 u. 12)

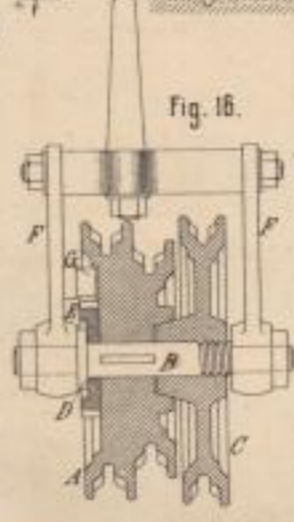

Fig. 16.

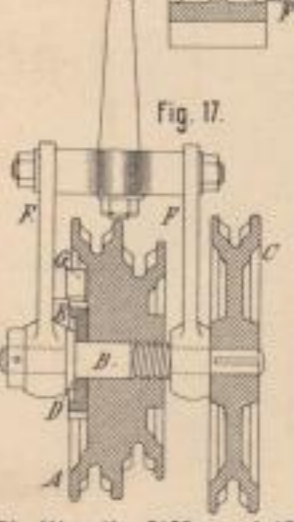

Fig. 17.

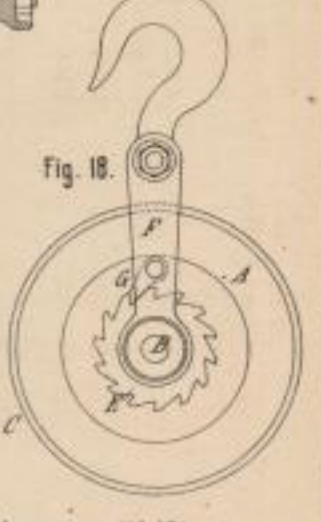
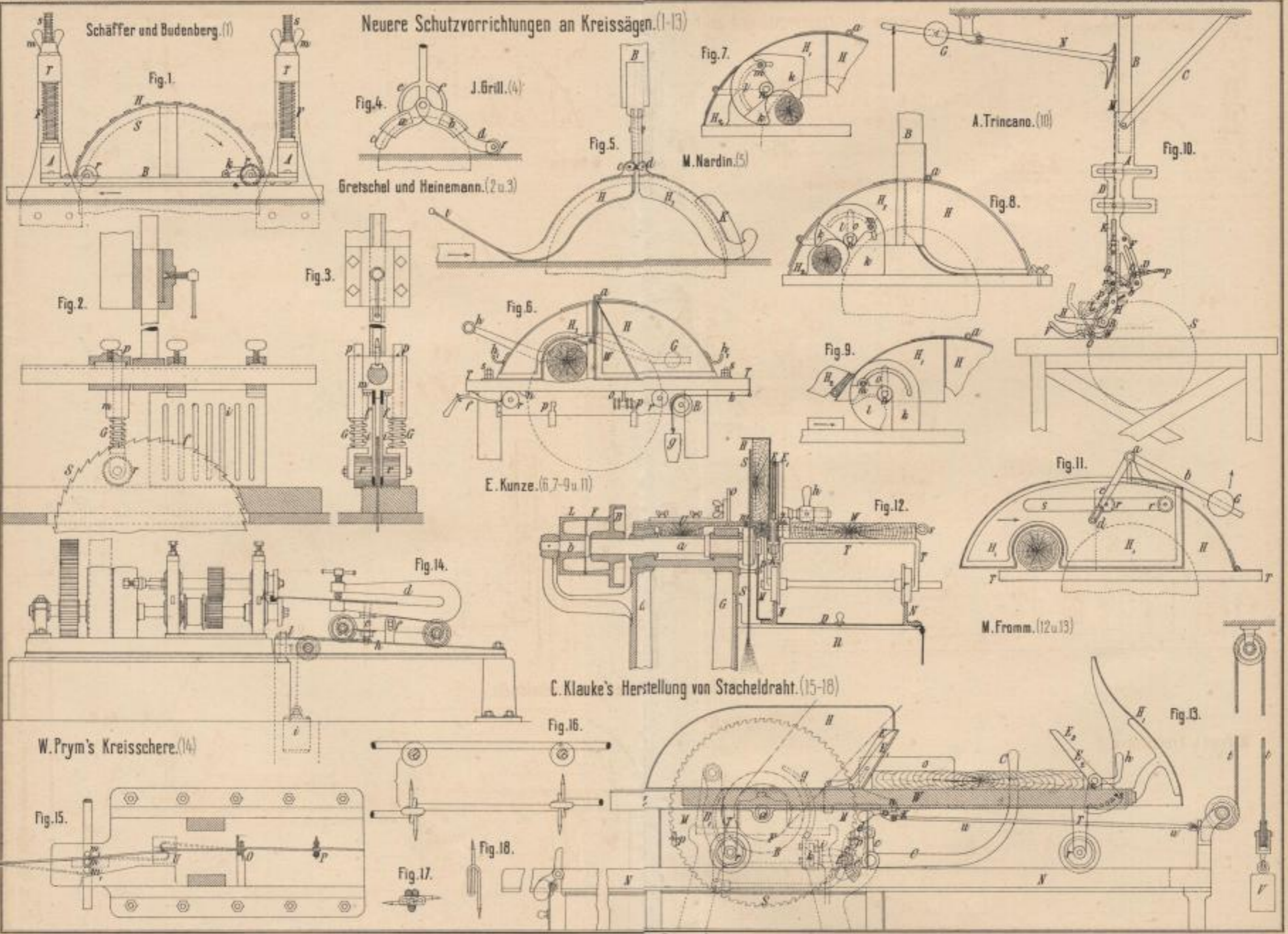

Fig. 18.

Th. Ward's Differentialflaschenzug. (16-18)

Lith. Anst. v. J. W. W. Darmstadt.



C. Klauke's Herstellung von Stacheldraht. (15-18)

Lith. Anst. v. F. Wra. Darmstadt.

Neuerungen im Eisenhüttenwesen. (1-11.)

G. Duryee. (1.)

Fig. 1.

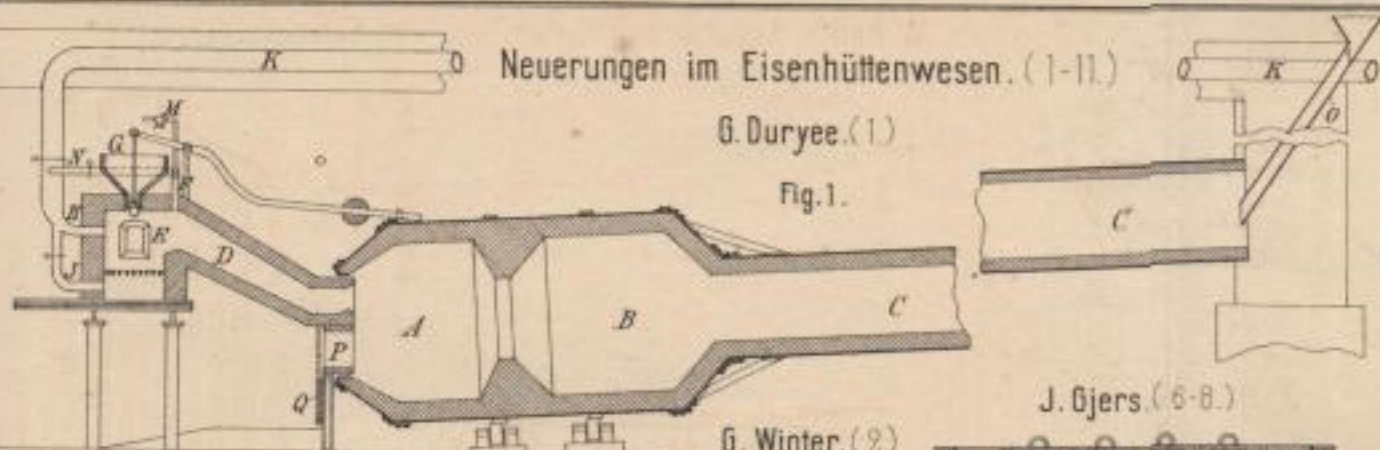

G. Winter. (9.)

Fig. 3.

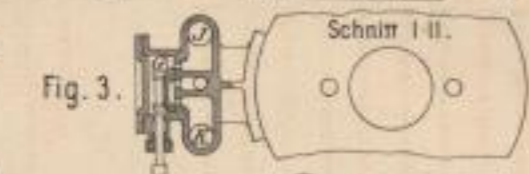
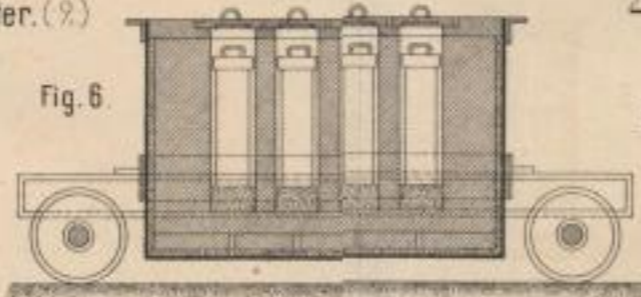

Fig. 6.



J. Gjers. (6-8.)

Fig. 2.

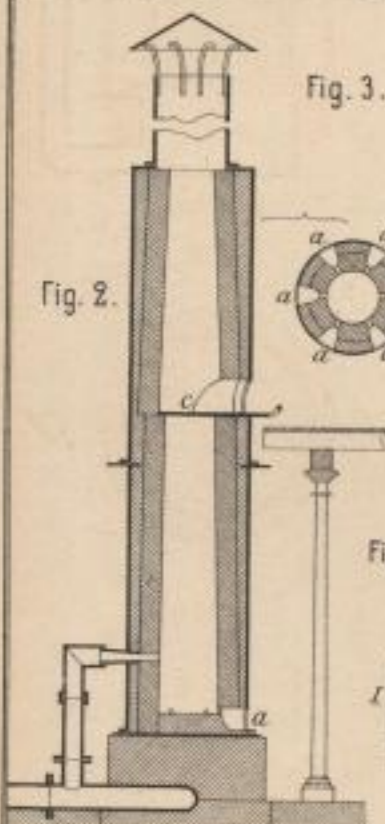

Fig. 4.

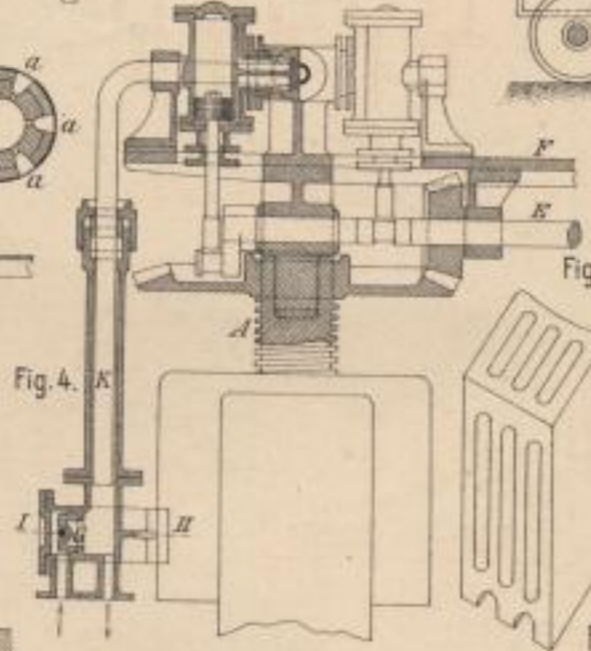

Fig. 7.

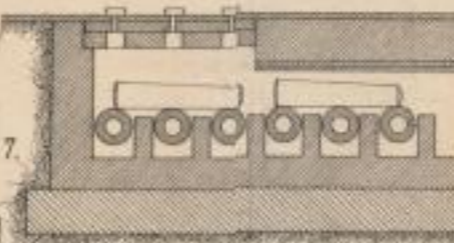

Fig. 5.



Fig. 8.

Ph. Justice. (5.) F. R. Asthöwer. (9-11.)

R. M. Daelen. (3 u 4.)

Fig. 9.

Fig. 10.

Fig. 11.

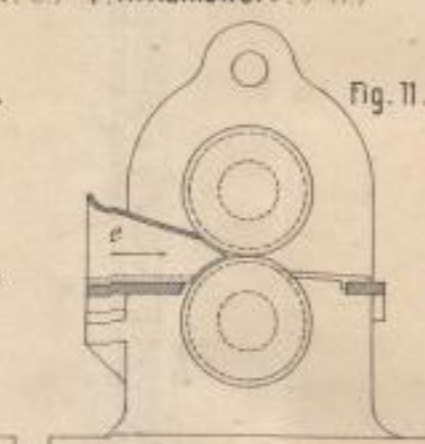
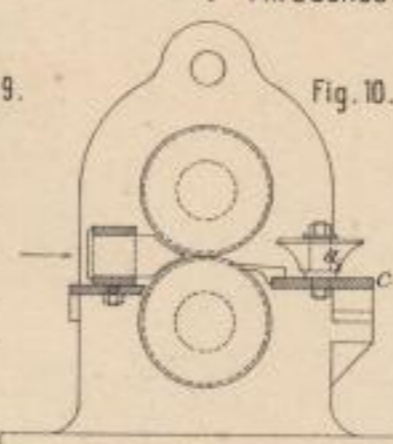
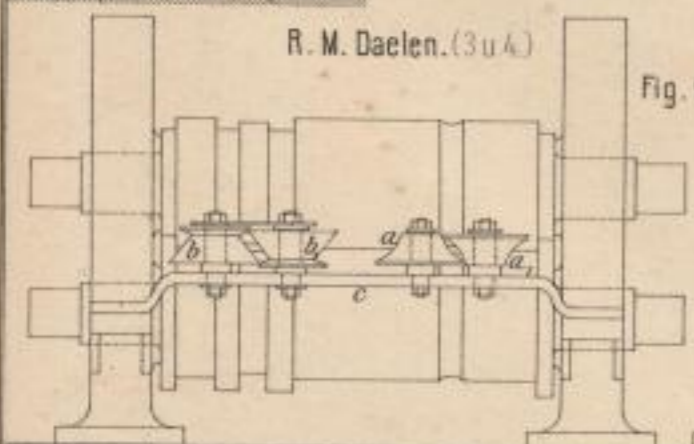

W. Rath's Apparat zur Herstellung von Schwefelsäure. (12-16.)

Fig. 12.

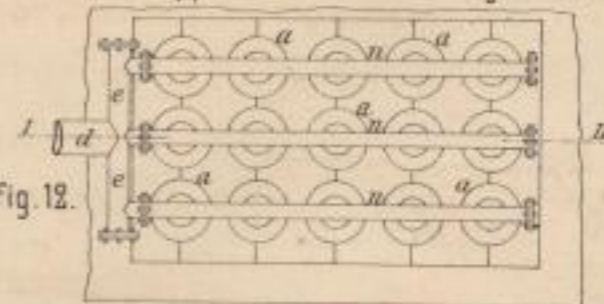
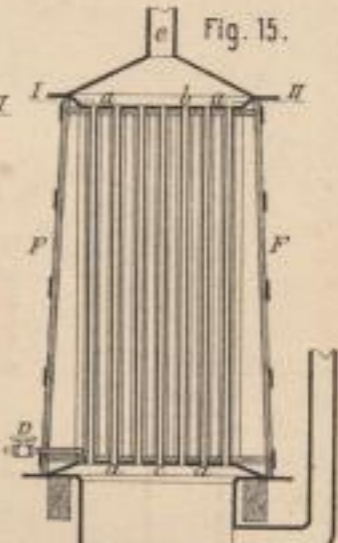
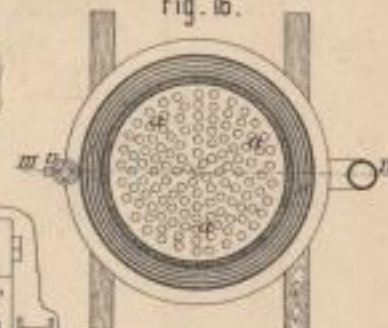

Fig. 15.



Schnitt III-IV.

Fig. 16.



Schnitt I-II.

Fig. 18.

Fig. 13.

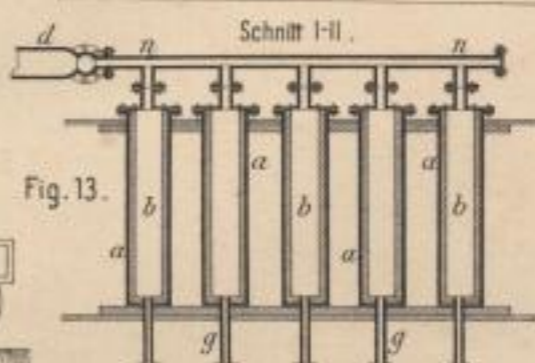
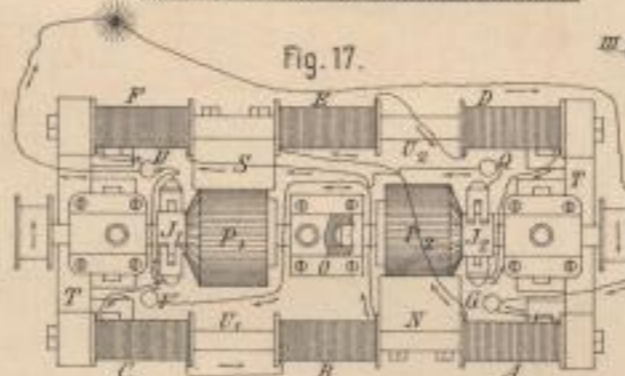

Fig. 14.



Fig. 17.



C. E. Ball's Dynamomaschine. (17 u. 18.)

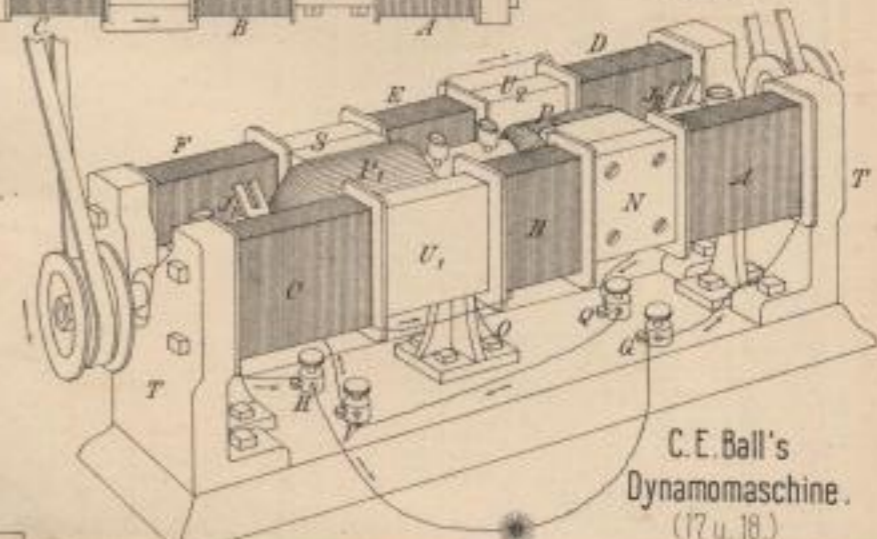

Lith. Anst. v. F. Wirtz, Darmstadt

Ausschneiden der Zapfen. (11u2)

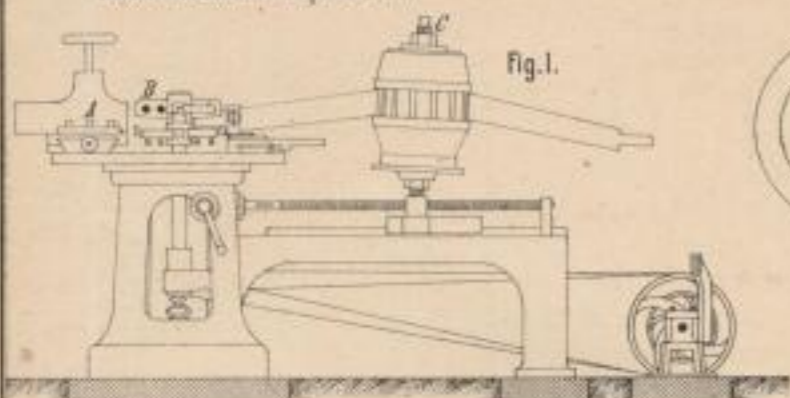

Fig. 1.

Périn und Panhard's Verfertigung hölzerner Wagenräder. (Taf 33)

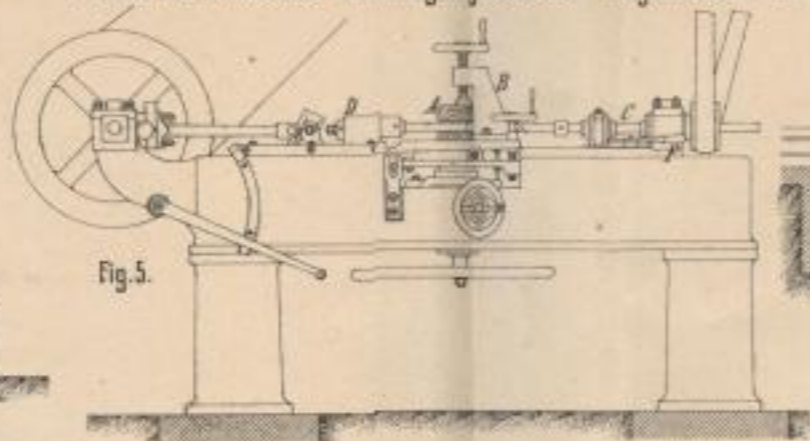

Fig. 5.

Presse zum Zusammensetzen. (9)

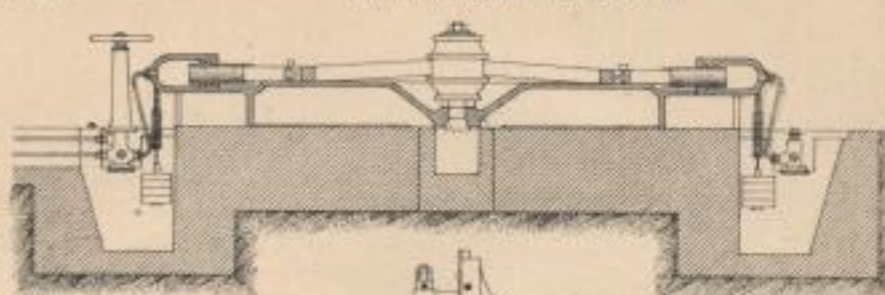

Fig. 9.

Fig. 2.

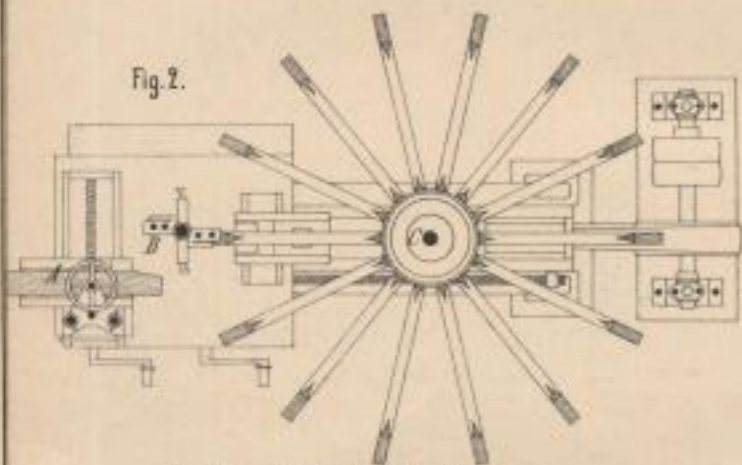
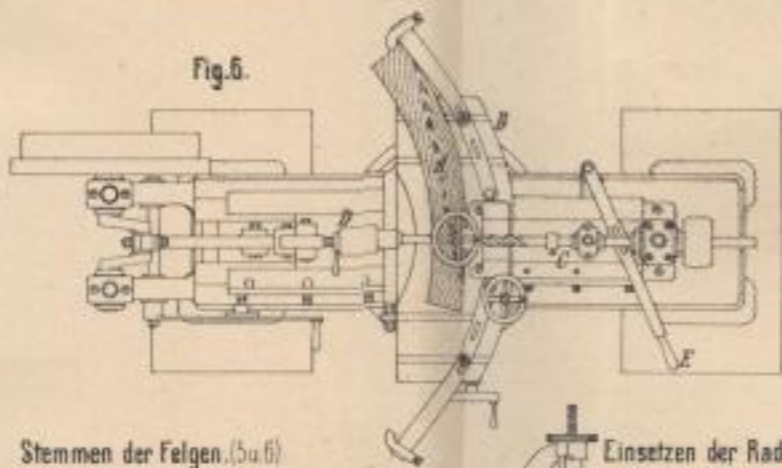

Fig. 6.



Einschneiden der Naben. (10u11)

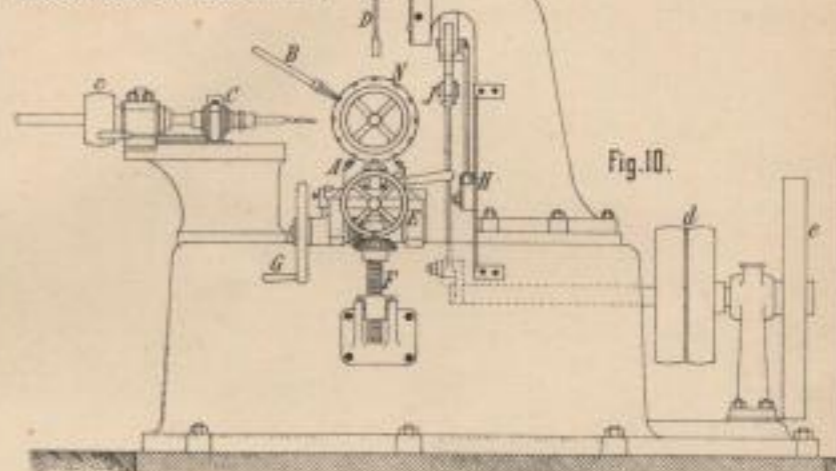

Fig. 10.

Zurichten der Felgen. (3u4u12)

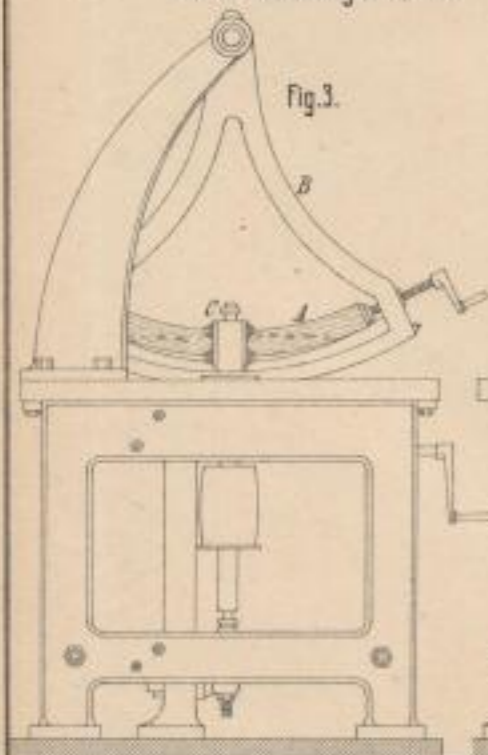

Fig. 3.

Stemmen der Felgen. (5u6)

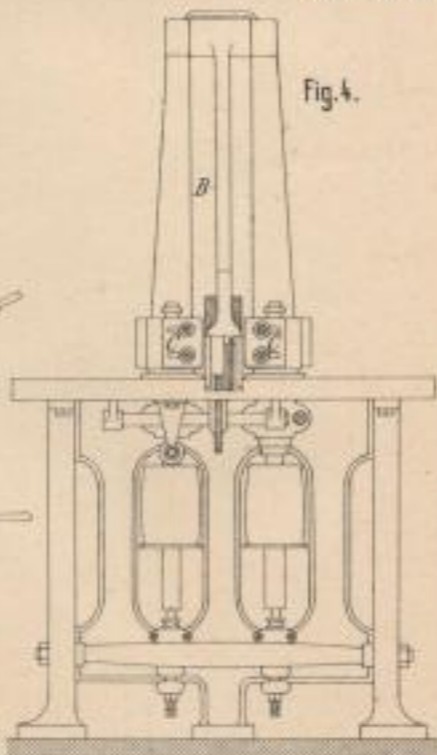

Fig. 4.

Einsetzen der Radbüchsen. (7u8)

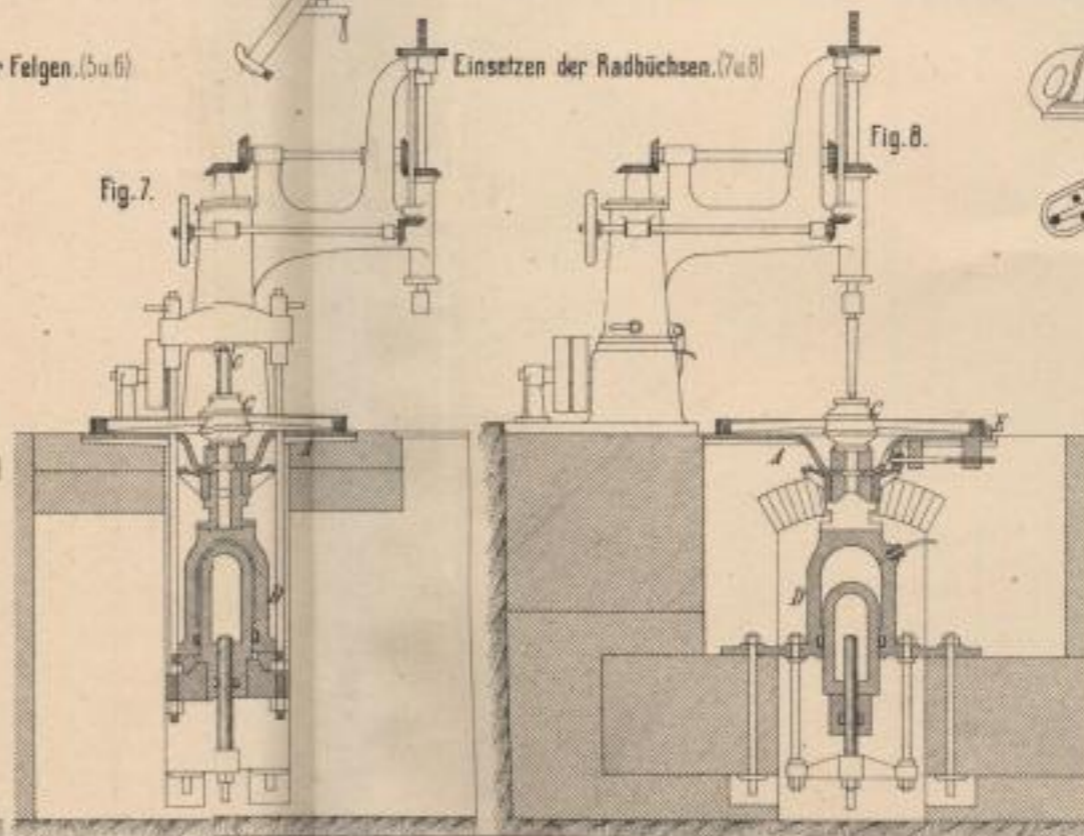

Fig. 7.

Fig. 8.

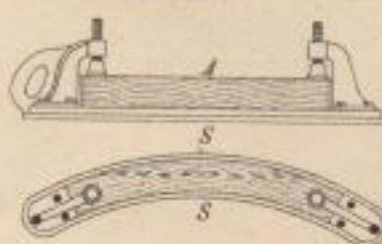
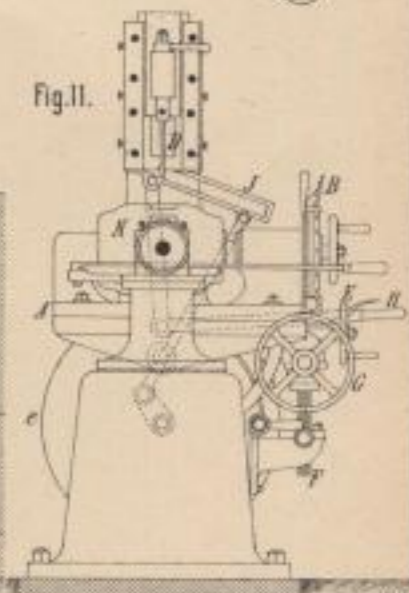
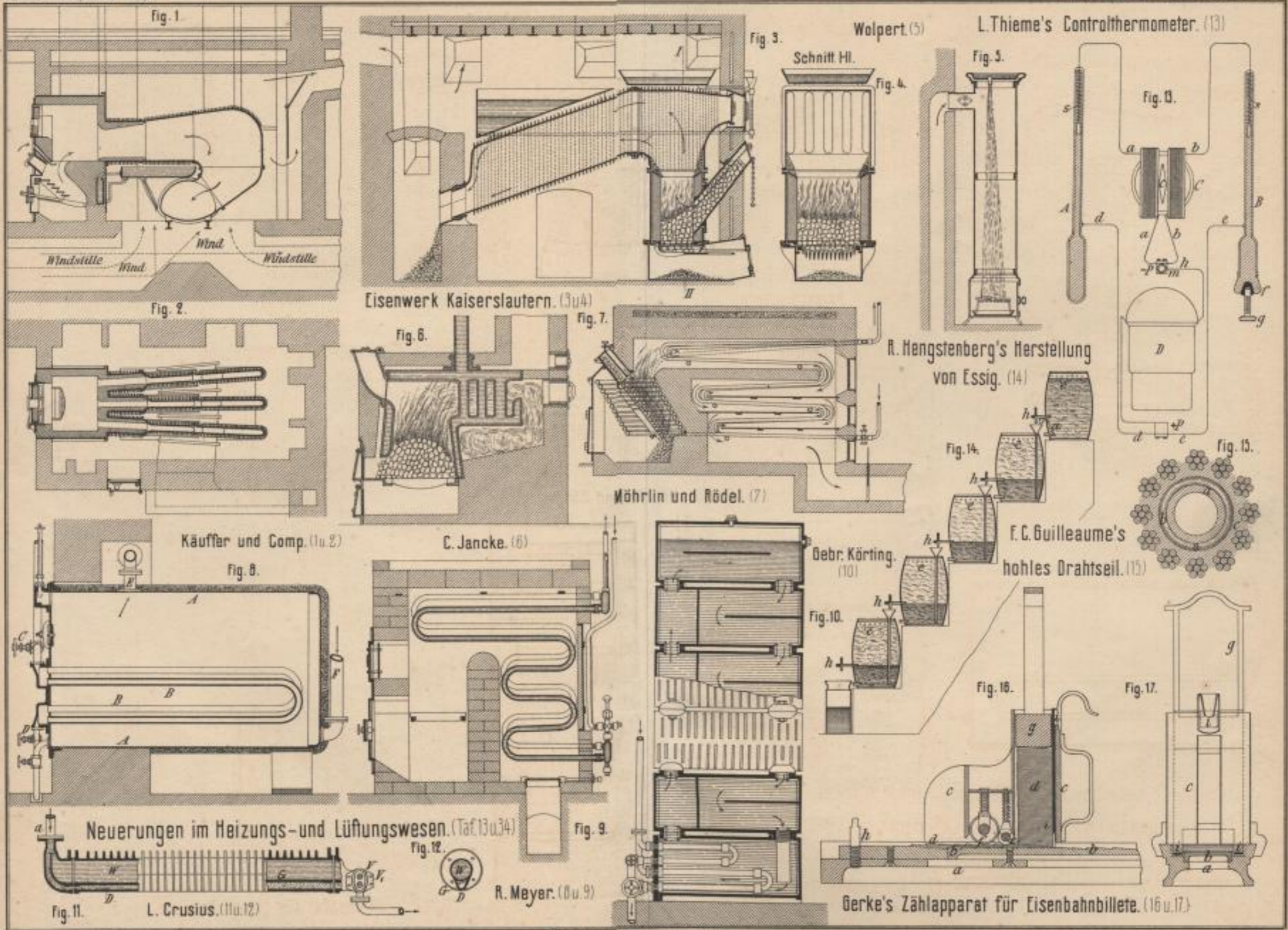

Fig. 12.

Fig. 11.



Loth. Aus v. P. Rev. Journ. 1871.



Lith. Anst. v. F. Wirtz, Darmstadt.

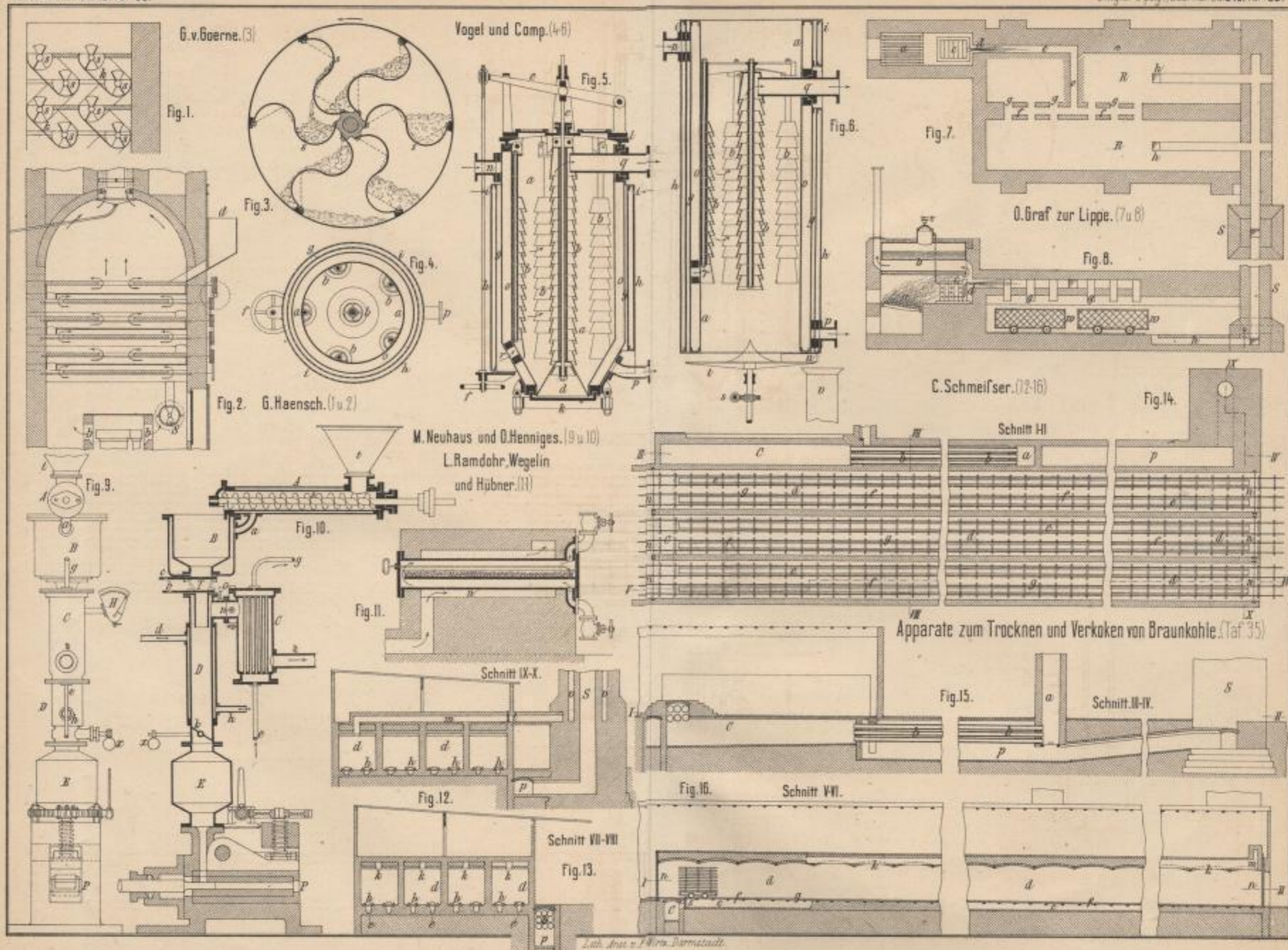

Lith. Anst. v. J. W. Neumann.

Sächs.
Landes-
Bibl



Kanzlei
Bücherei
DRESDEN



Technol. A. 264

SLUB DRESDEN



3 2422829