

03333

Atlas

zu

Dingler's polytechnischem Journal.

Band 247.

(Vierundsechzigster Jahrgang.)

Jahrgang 1883.

Enthaltend 38 lithographirte Tafeln.



Stuttgart.

Verlag der J. G. COTTA'schen Buchhandlung.

02121

1881

Journal der Naturforschenden Gesellschaft

Band 21

Verlagsgesellschaft für Naturwissenschaften

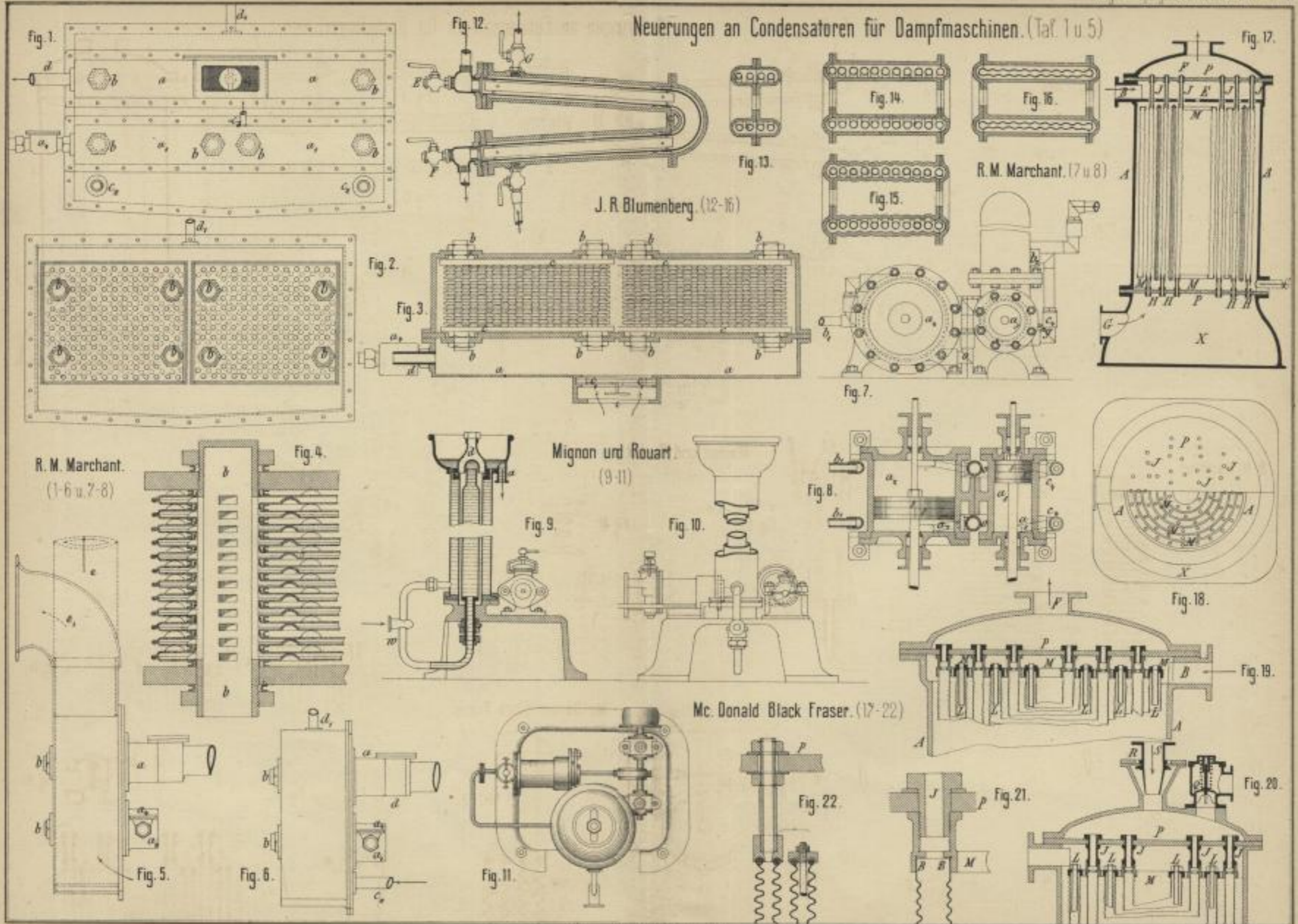
Leipzig 1881

Verlagsgesellschaft für Naturwissenschaften



Sächs.
Landesbibl.
Dresden

Neuerungen an Condensatoren für Dampfmaschinen. (Taf. 1 u 5)



J. R. Blumenberg. (12-16)

R. M. Marchant. (7 u 8)

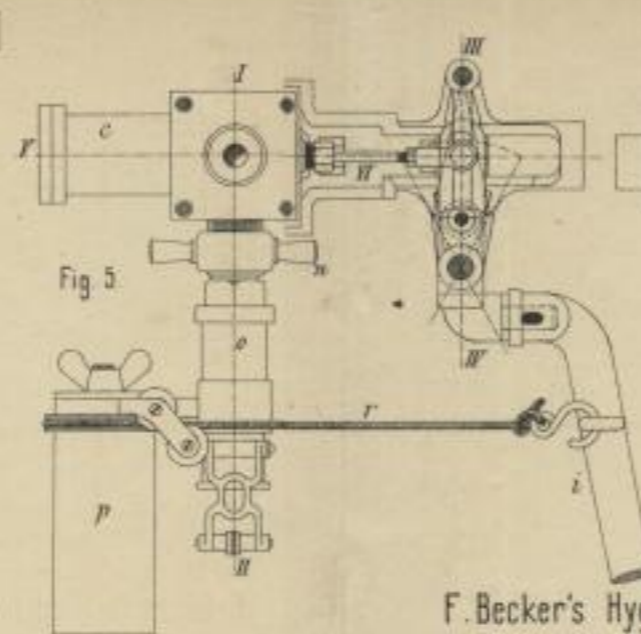
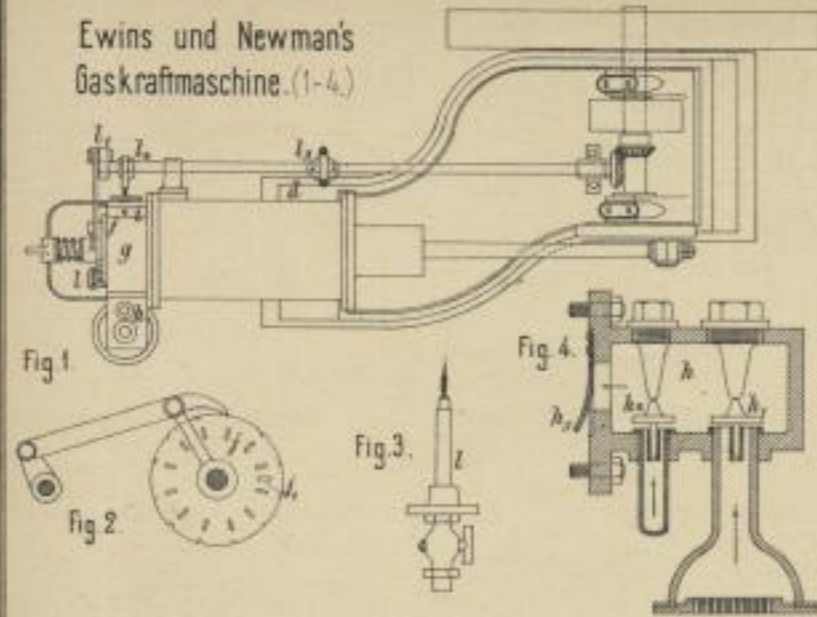
Mignon und Rouart. (9-11)

Mc. Donald Black Fraser. (17-22)

R. M. Marchant. (1-6 u 7-8)

Leit. Anst. v. F. Wirtz, Darmstadt.

Ewins und Newman's Gaskraftmaschine. (1-4.)



F. Becker's Hygro-Indicator. (5-8.)

Schnitt III-IV.

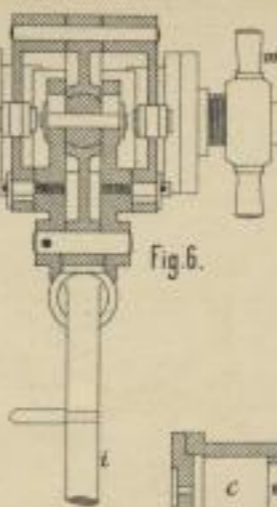


Fig. 6.

Schnitt I-II.

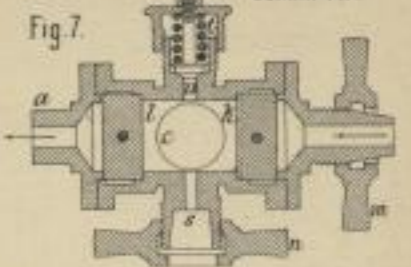


Fig. 7.

Schnitt V-VI.

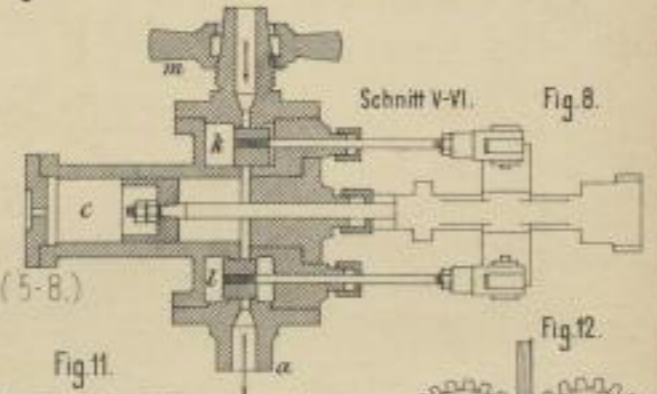
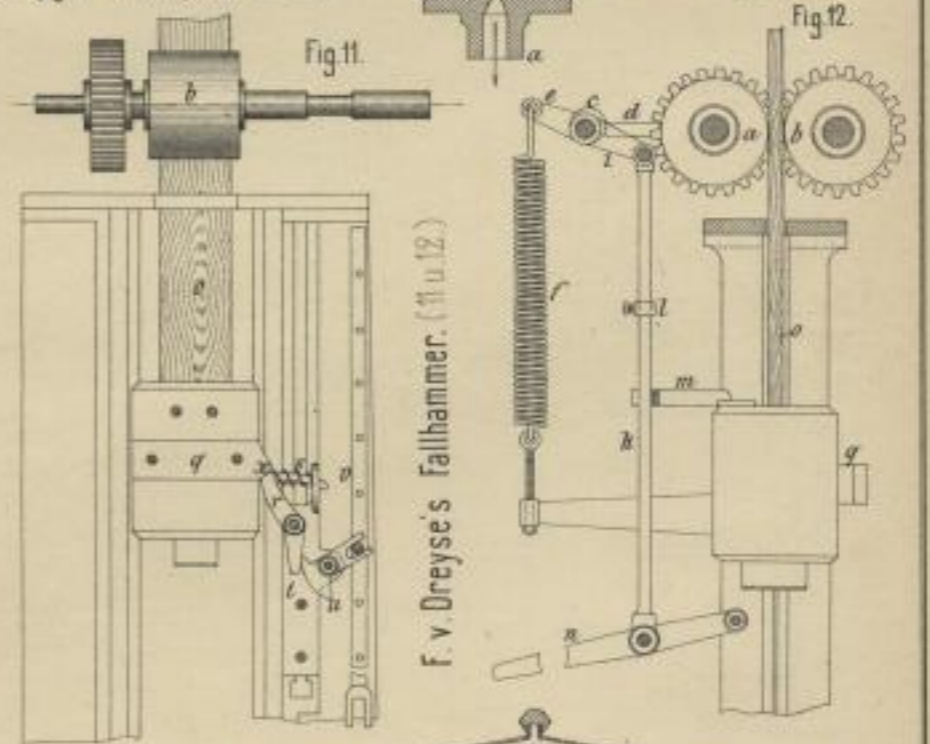


Fig. 8.

Fig. 11.



F. v. Dreyse's Fallhammer. (11 u. 12.)

J. N. Smith's Räder-Fräsdrehbank. (9 u. 10.)

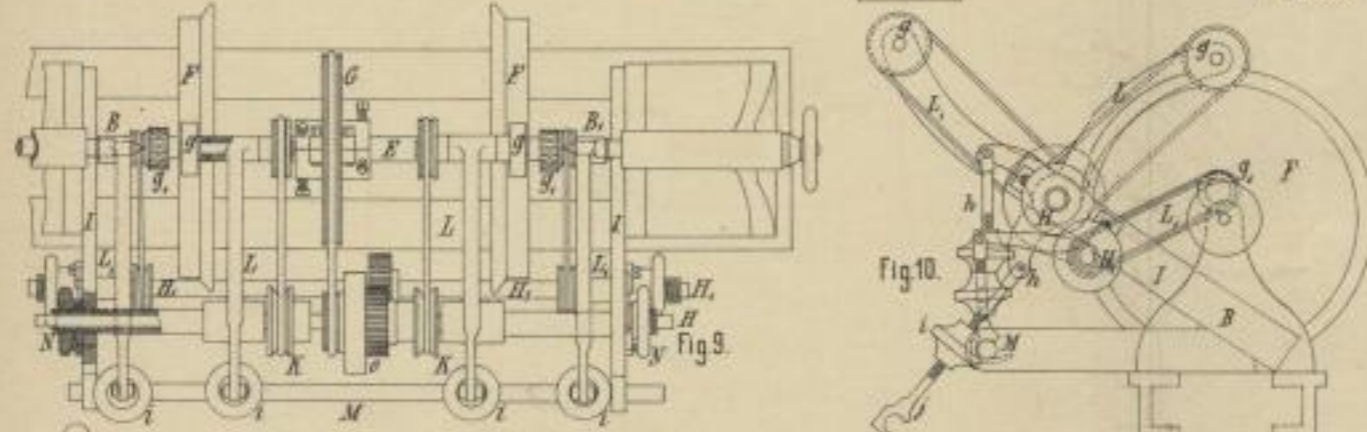


Fig. 10.

Fig. 13.

E. Hoyer's Papierzerreißapparat. (13 u. 14.)

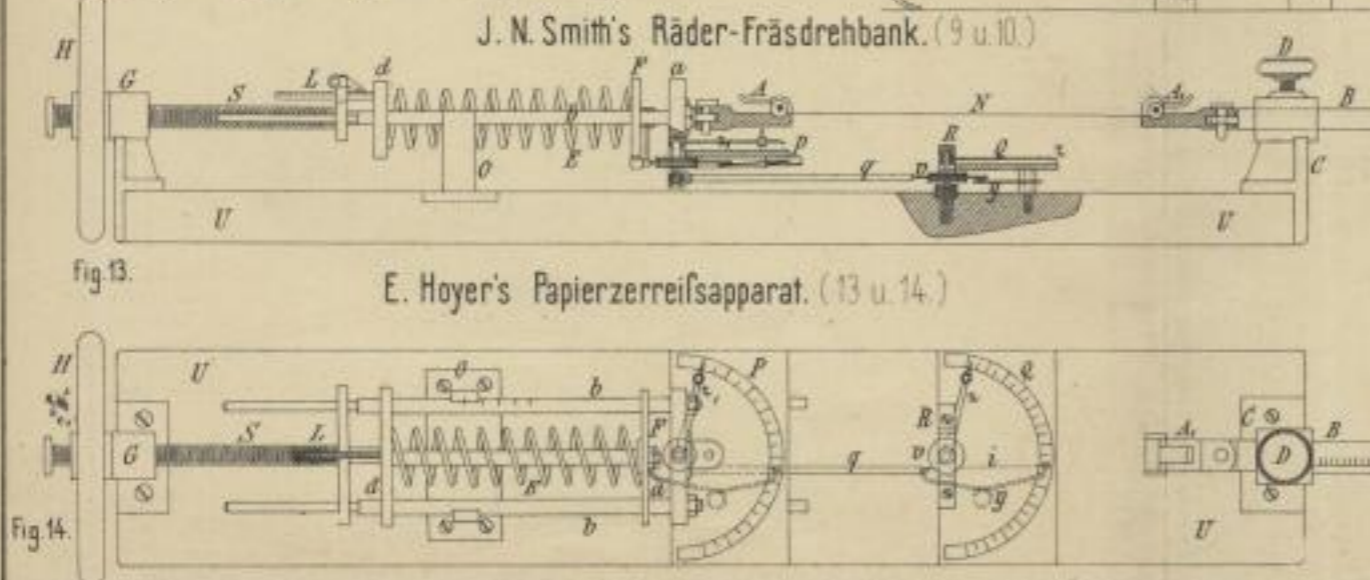


Fig. 14.

E. Grüneberg's Taschen-Kanalwaage. (15.)

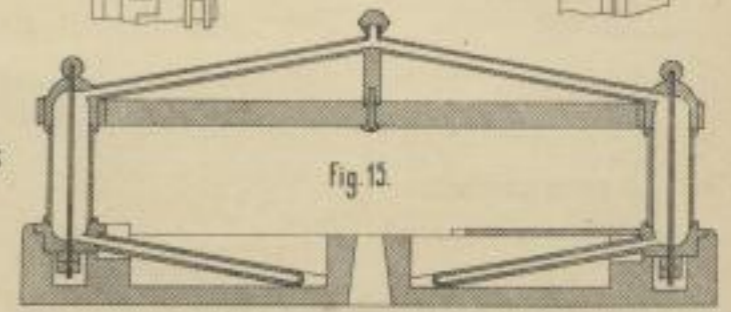


Fig. 15.

Lith. Anst. v. F. Witz. Darmstadt.

Gebr. Buderus. (1 u. 2.)

C. Geiseler. (3.)

F. Knupfer. (4.)

Neuerungen im Heizungs- und Lüftungswesen. (1-11.)

O. Braun's bez. Stoddard's Erdölprüfer. (14 u. 15, 16.)

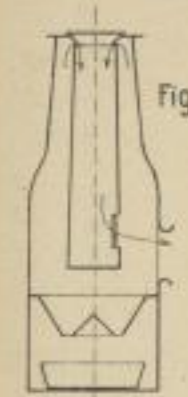


Fig. 1.

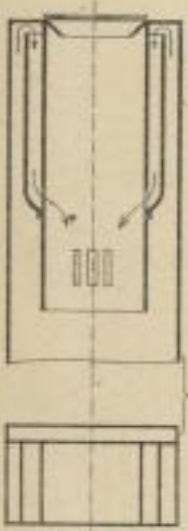


Fig. 2.

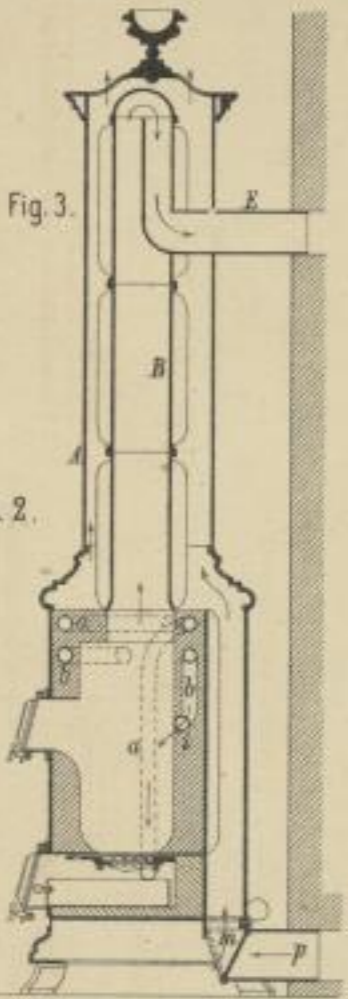


Fig. 3.

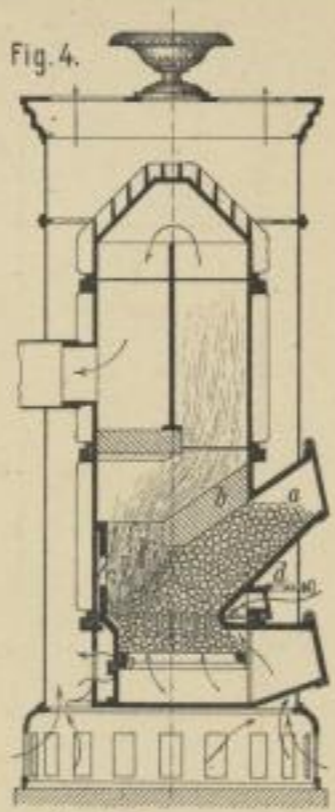


Fig. 4.

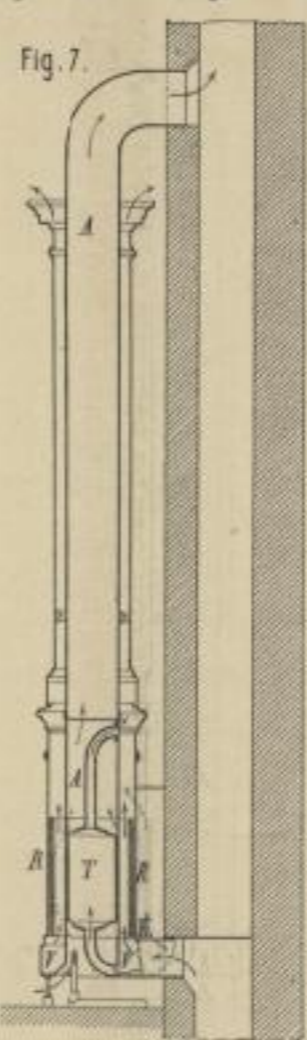


Fig. 7.

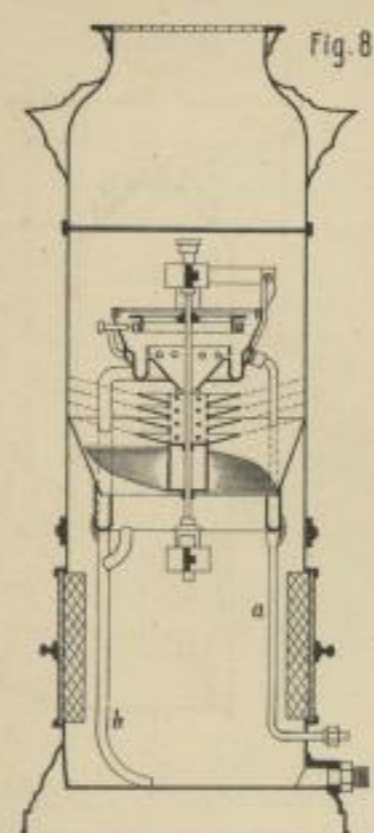
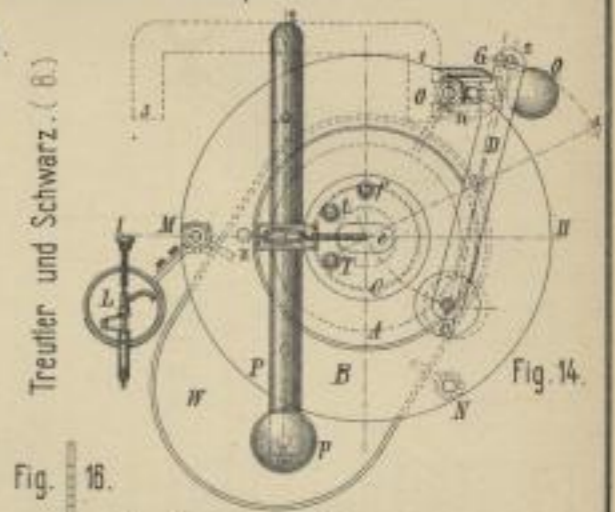


Fig. 8.



Treutter und Schwarz. (8.)

Fig. 14.

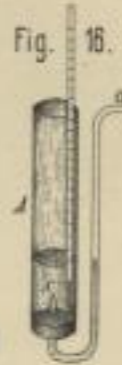


Fig. 16.

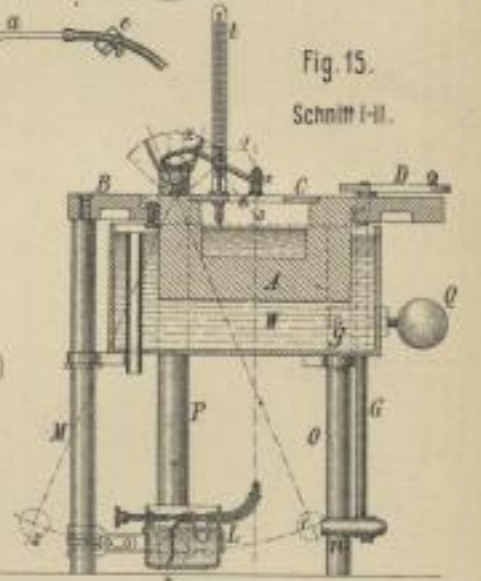


Fig. 15.

Schnitt I-II.

Jablochkoff's Elektrometer. (12 u. 13.)

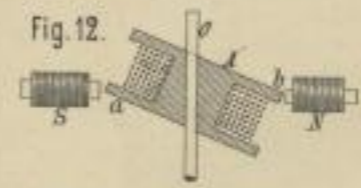


Fig. 12.

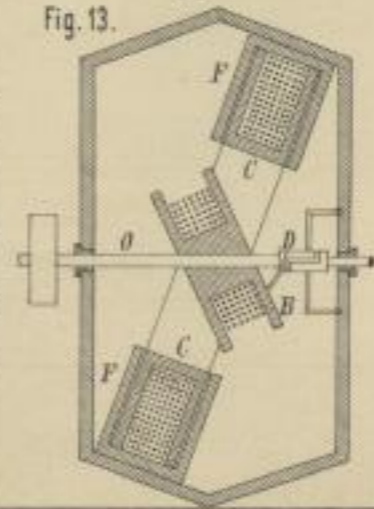


Fig. 13.

Ruchholz's Manometerprüfer. (17.)

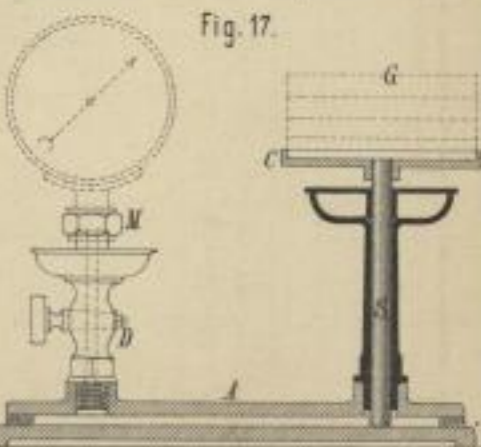


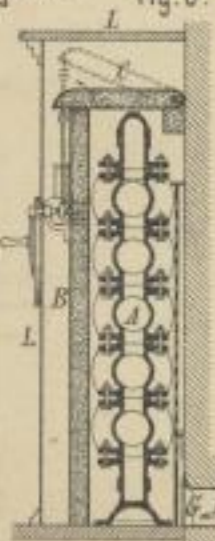
Fig. 17.

Th. Seeberger. (5.)

Fig. 5.

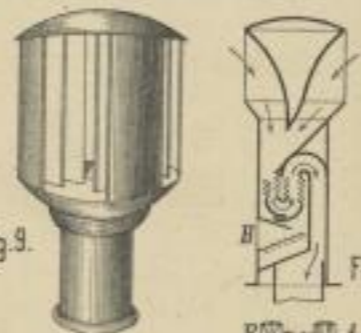


Fig. 6.



A. Bechem. (6.)

Fig. 9.



R. Boyle. (9-11.)

Fig. 10.

P. Käuffer. (7.)

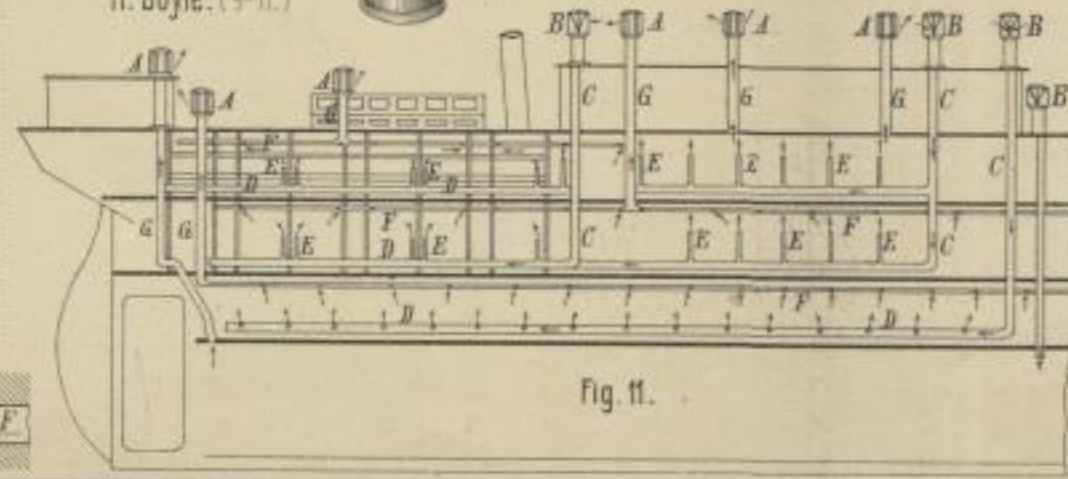
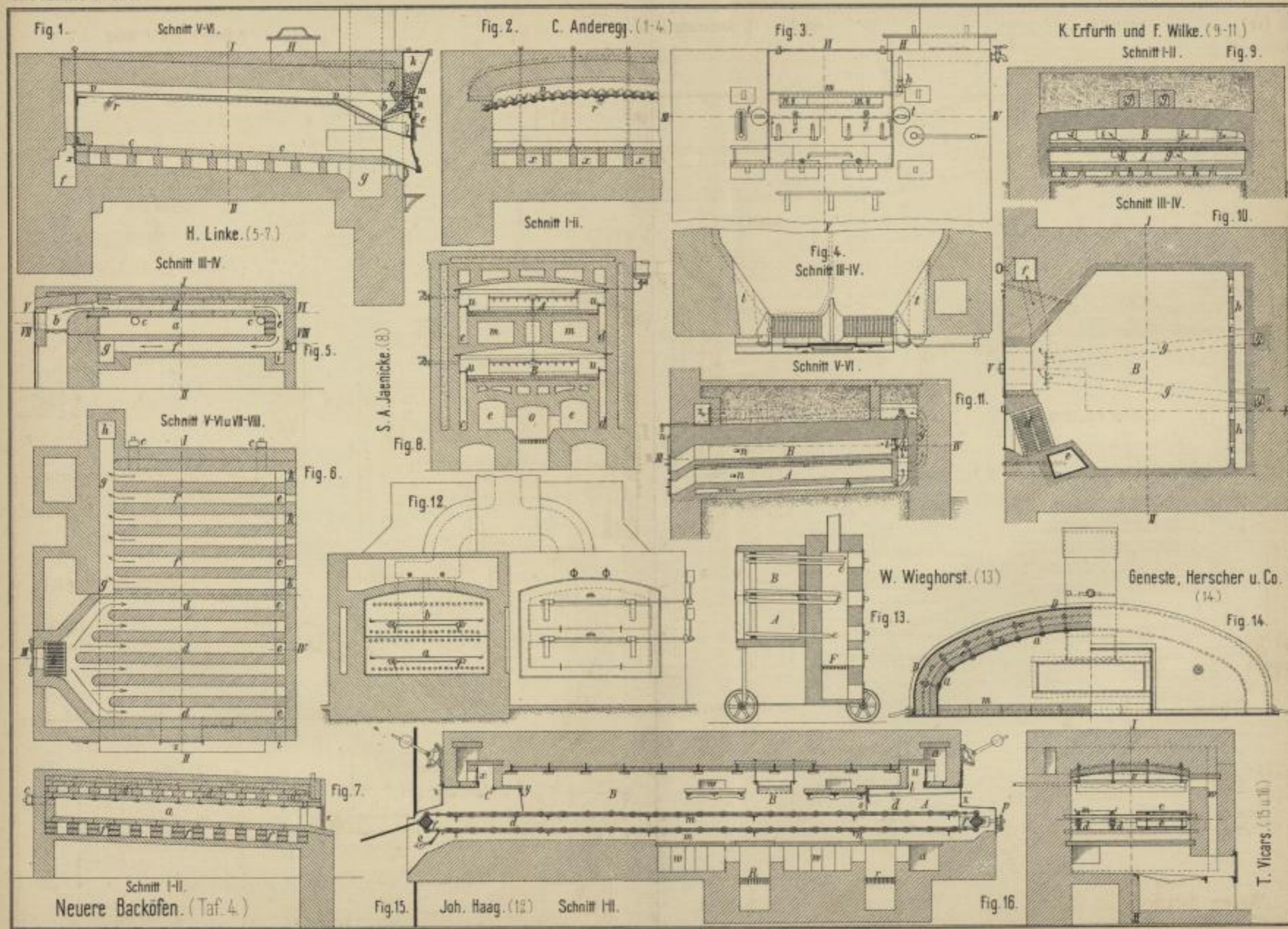


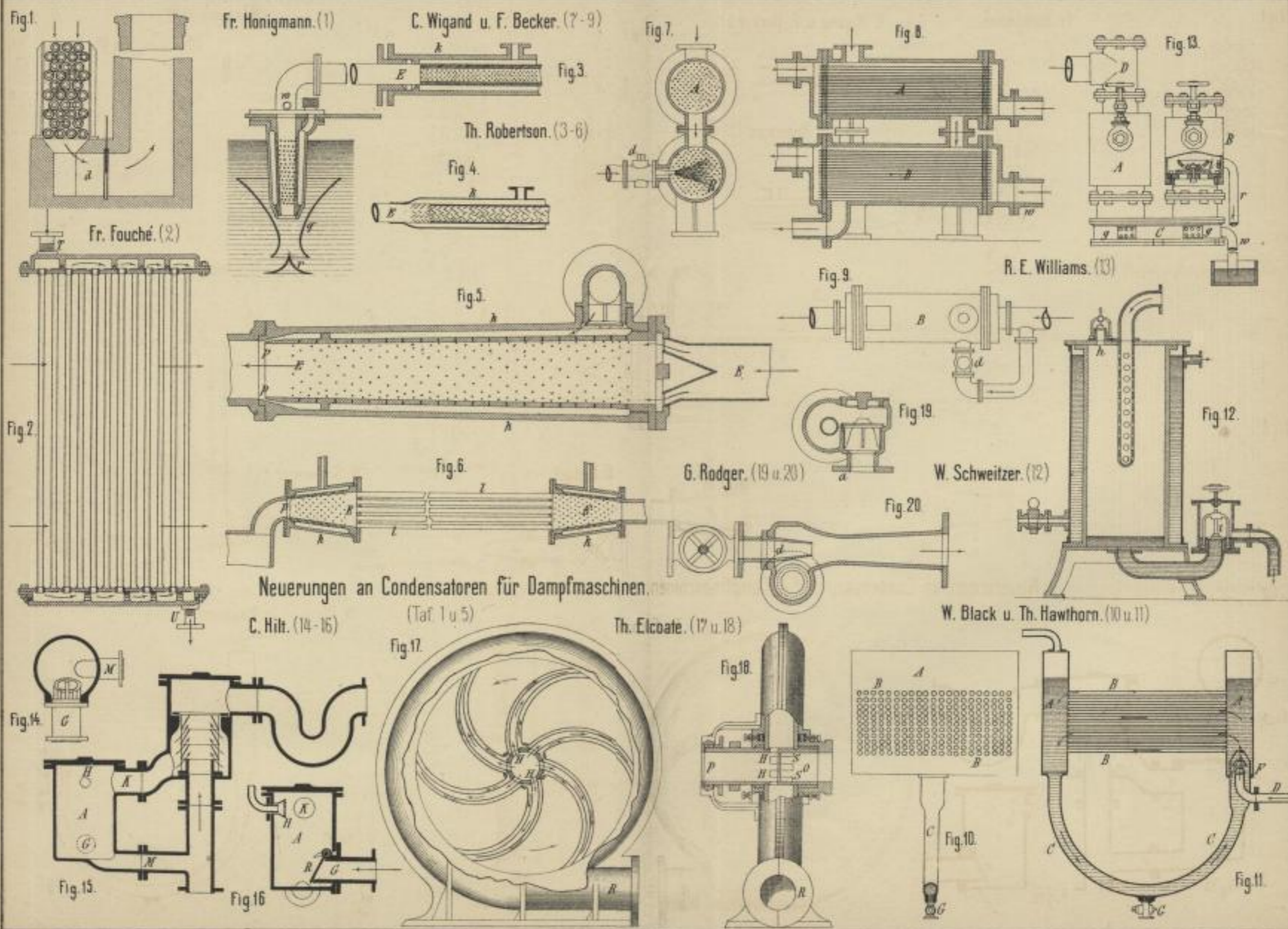
Fig. 11.

Lith. Anst. v. P. Witz, Darmstadt.

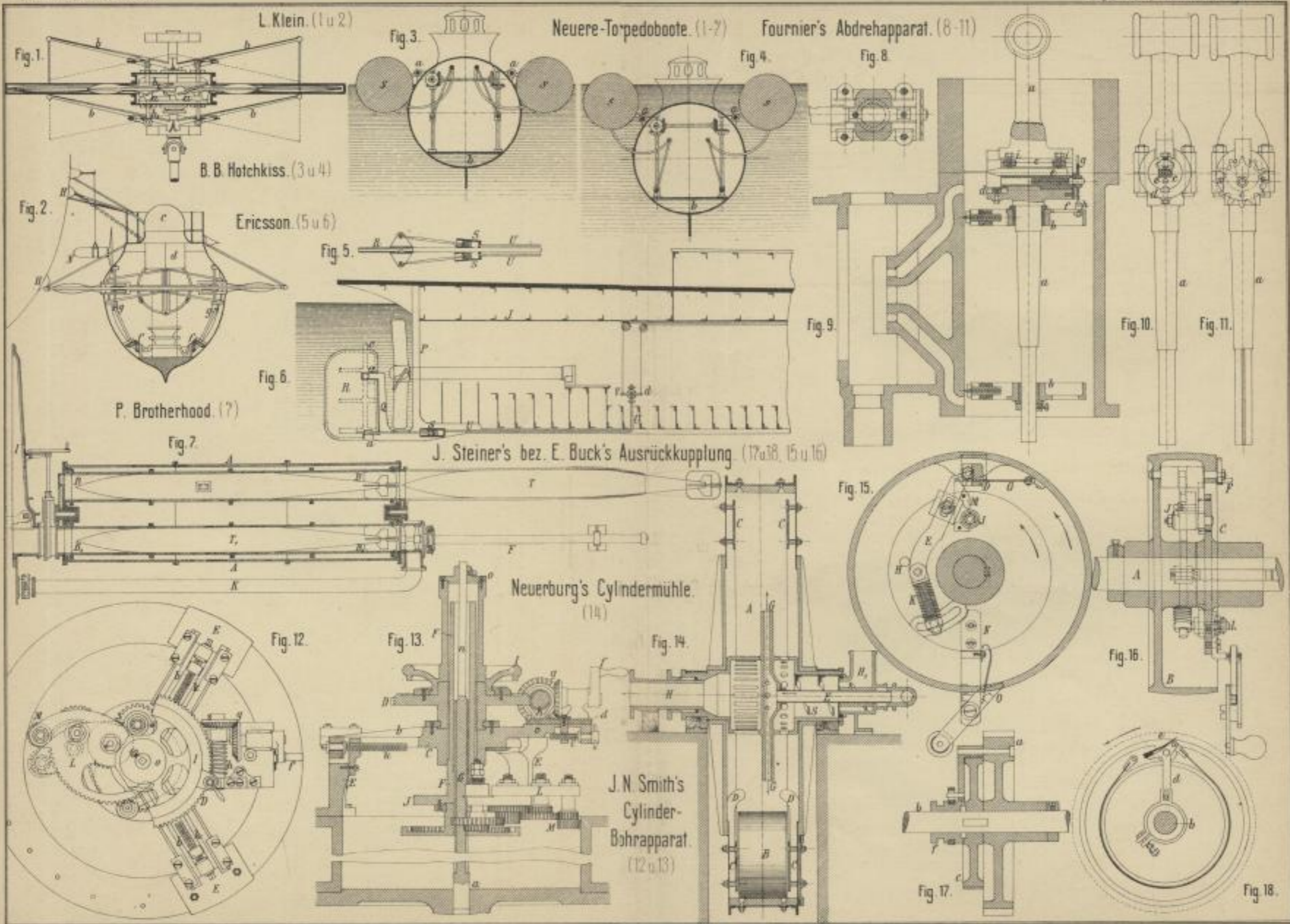




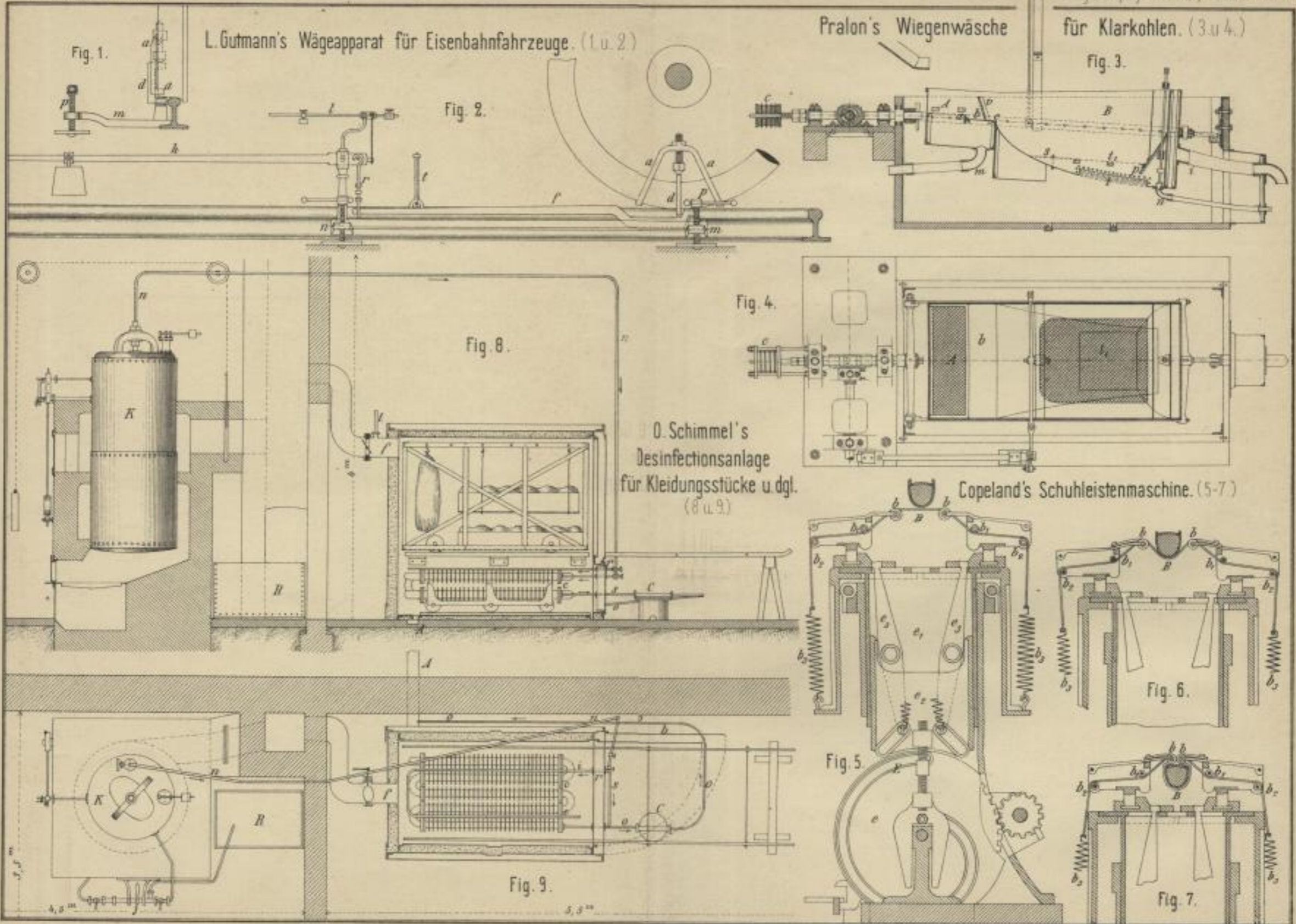
Leh. Abt. v. F. W. v. Dornstadt



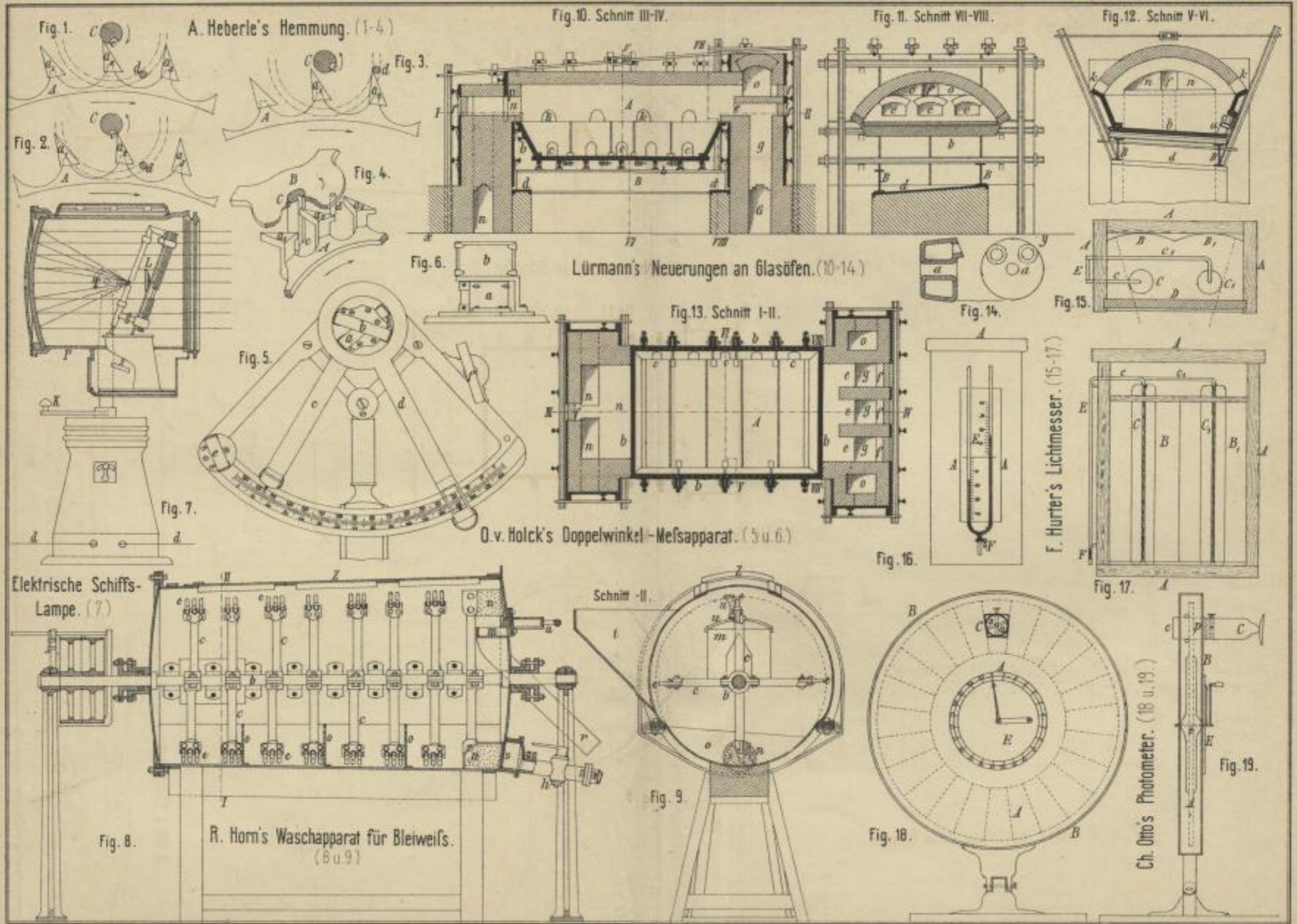
Lith. Anst. v. F. W. W. Darmstadt



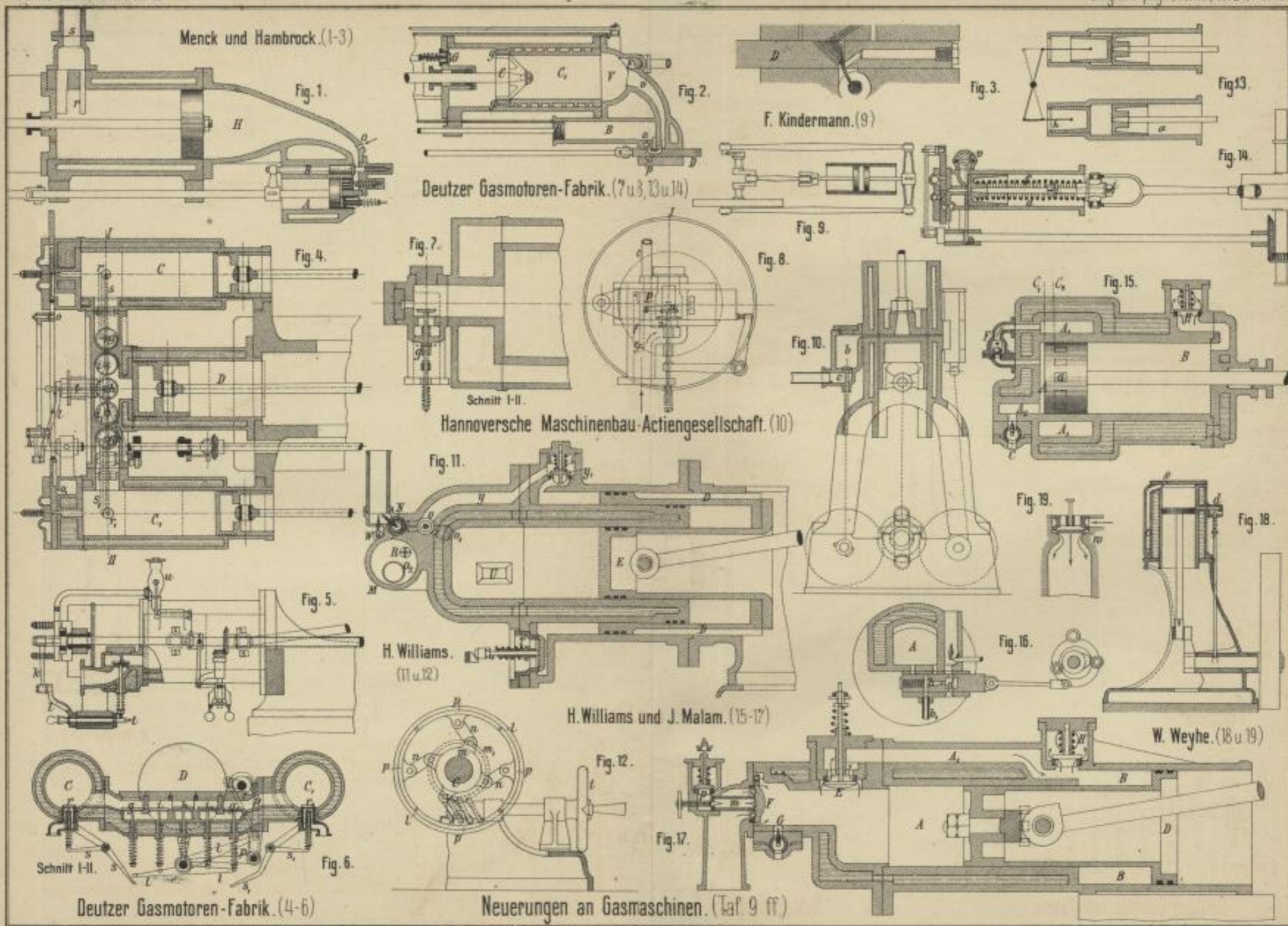
Lith. Anst. v. F. Witz, Darmstadt.



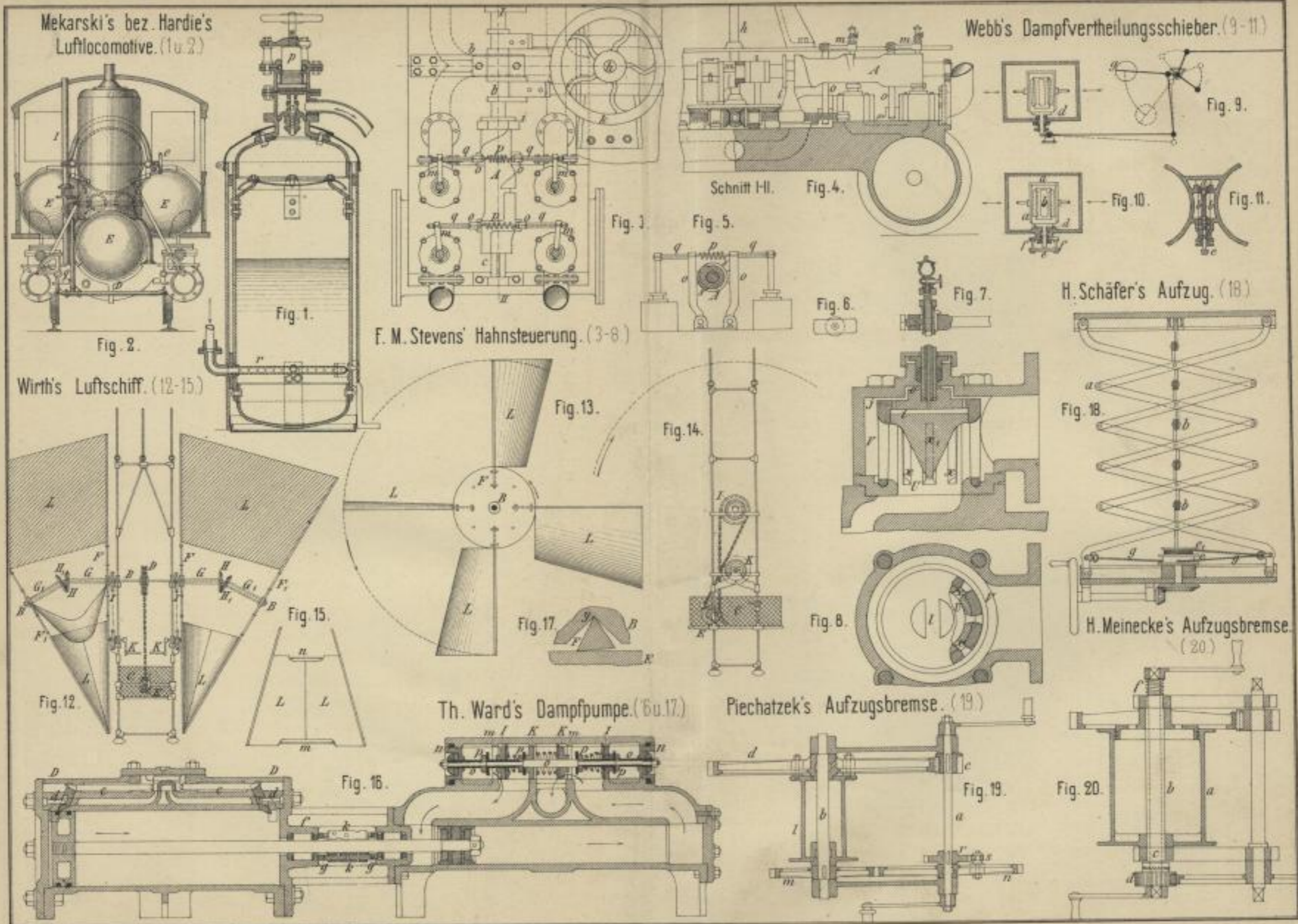
Lith. Anst. v. F. Wirtz, Darmstadt.



205. - Phot. v. J. W. v. Dornier

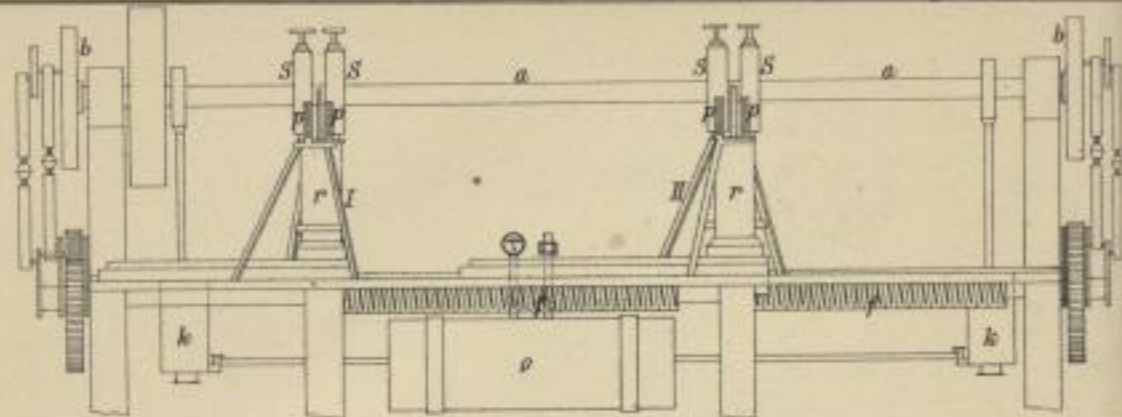


Lith. Anst. v. F. Wirtz, Darmstadt.

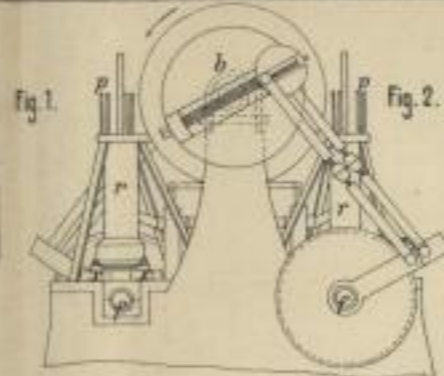


Lith. Anst. v. F. Wenz, Darmstadt.

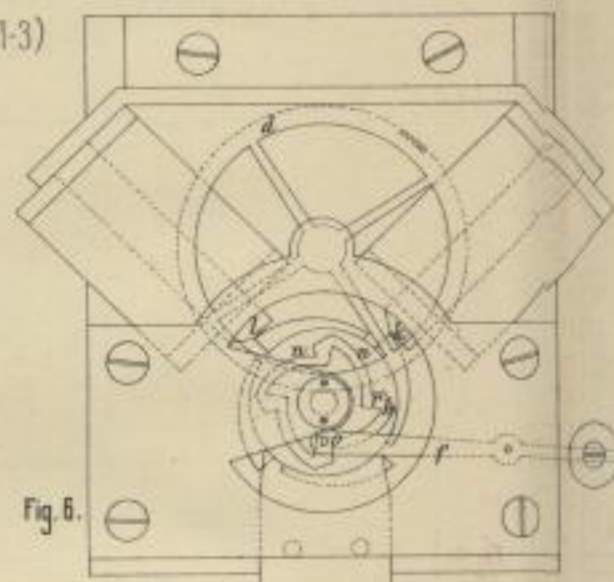
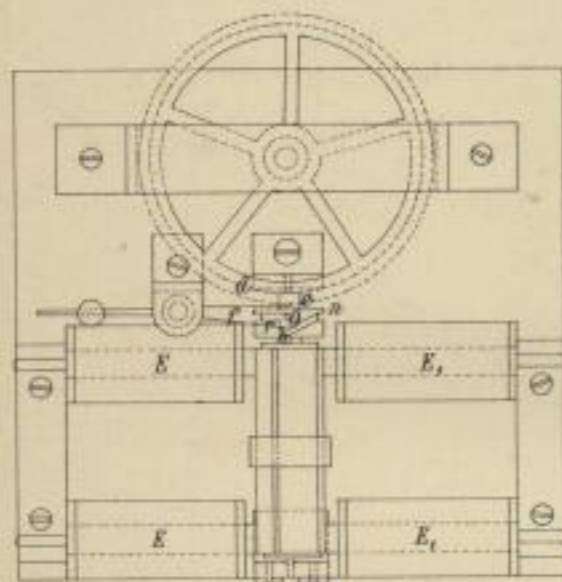
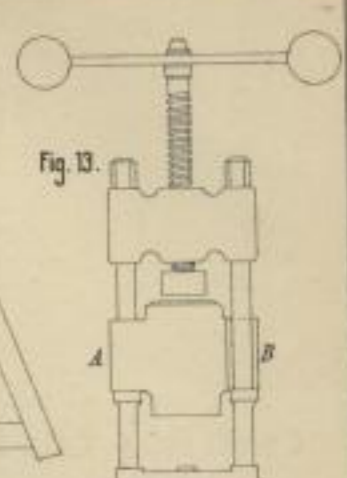
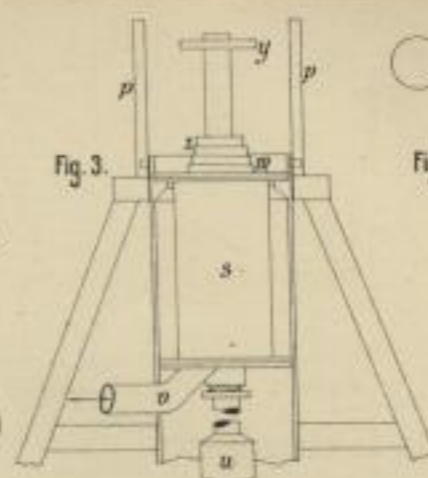




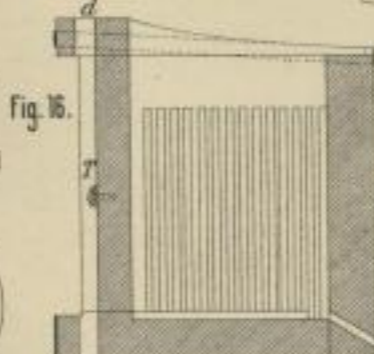
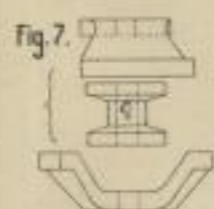
A. Groth und W. Rath's Feilenhaumaschine. (1-3)



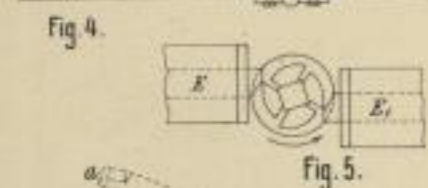
W. Lederle. (13-15)



Grau's elektrische Uhr. (4-8)

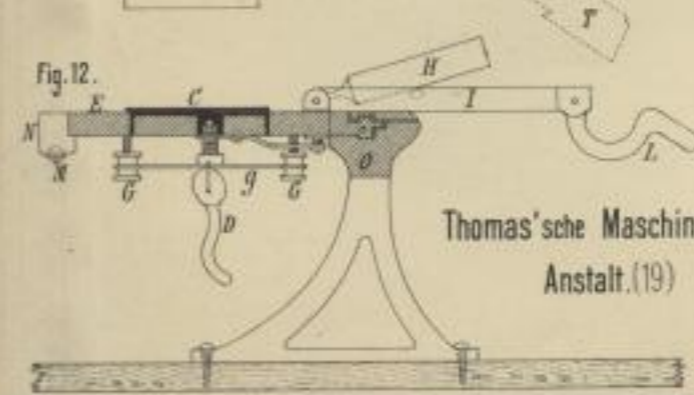
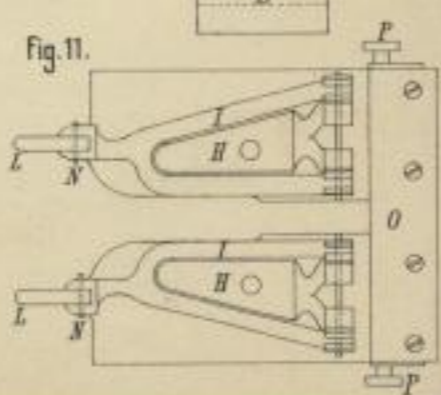
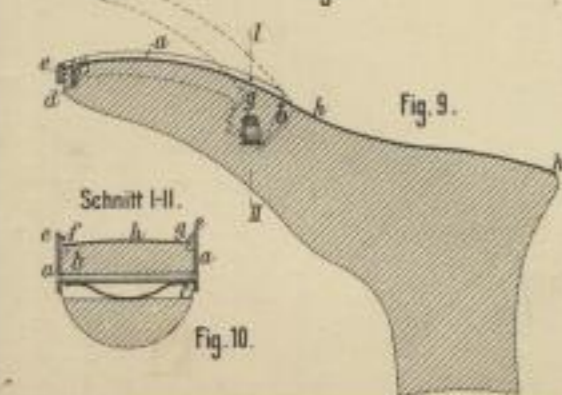


Neuerungen an Pressen. (13-15, 16-18, 19)

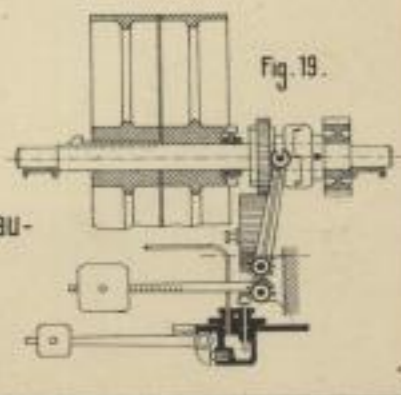


S. Wolf's Apparat zum Aufkleben von Einlegsohlen. (9 u 10)

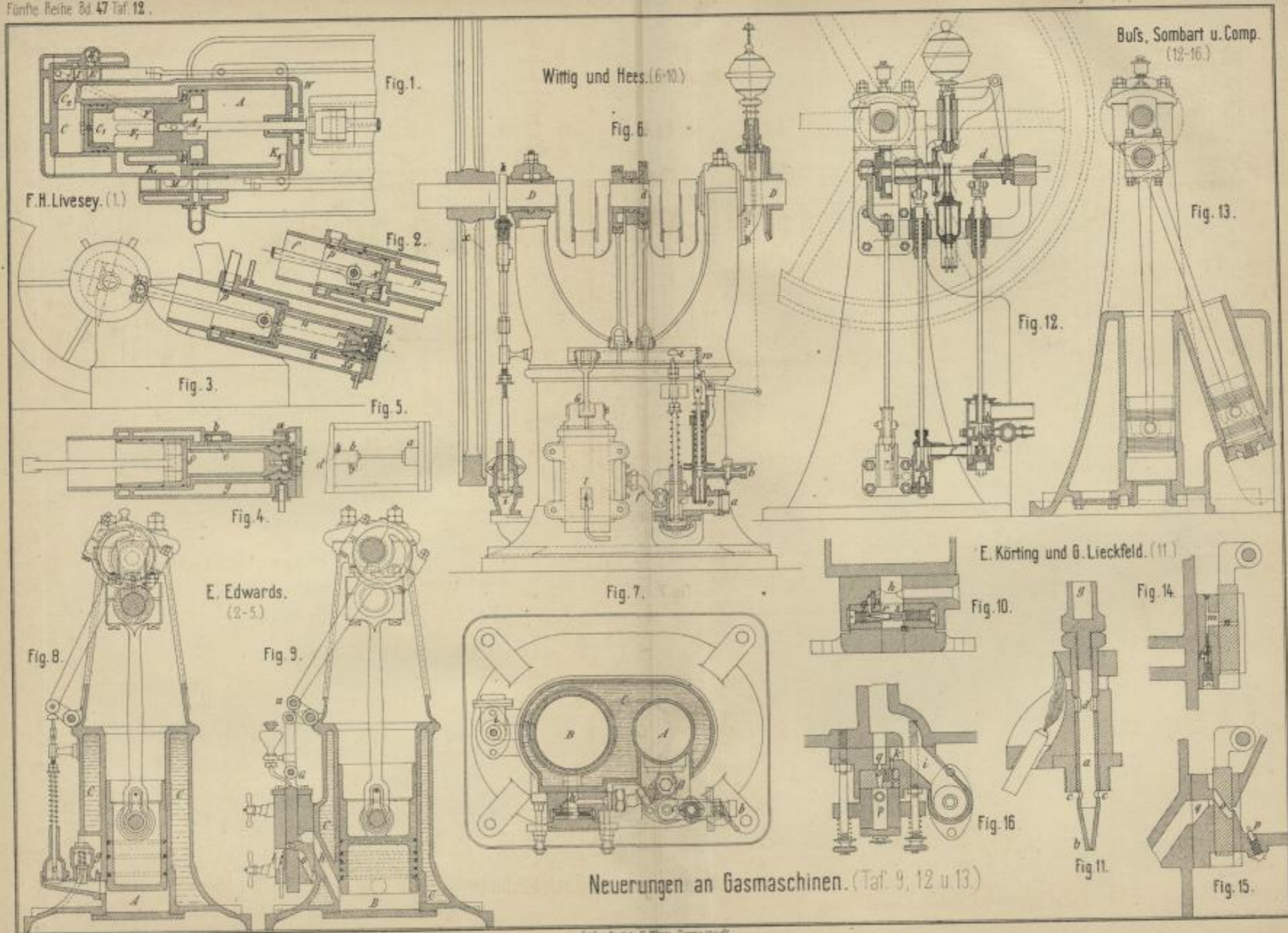
E. Hackin's Apparat zum Aufkleben v. Gummeinsätzen. (11 u 12)



Thomas'sche Maschinenbau-Anstalt. (19)



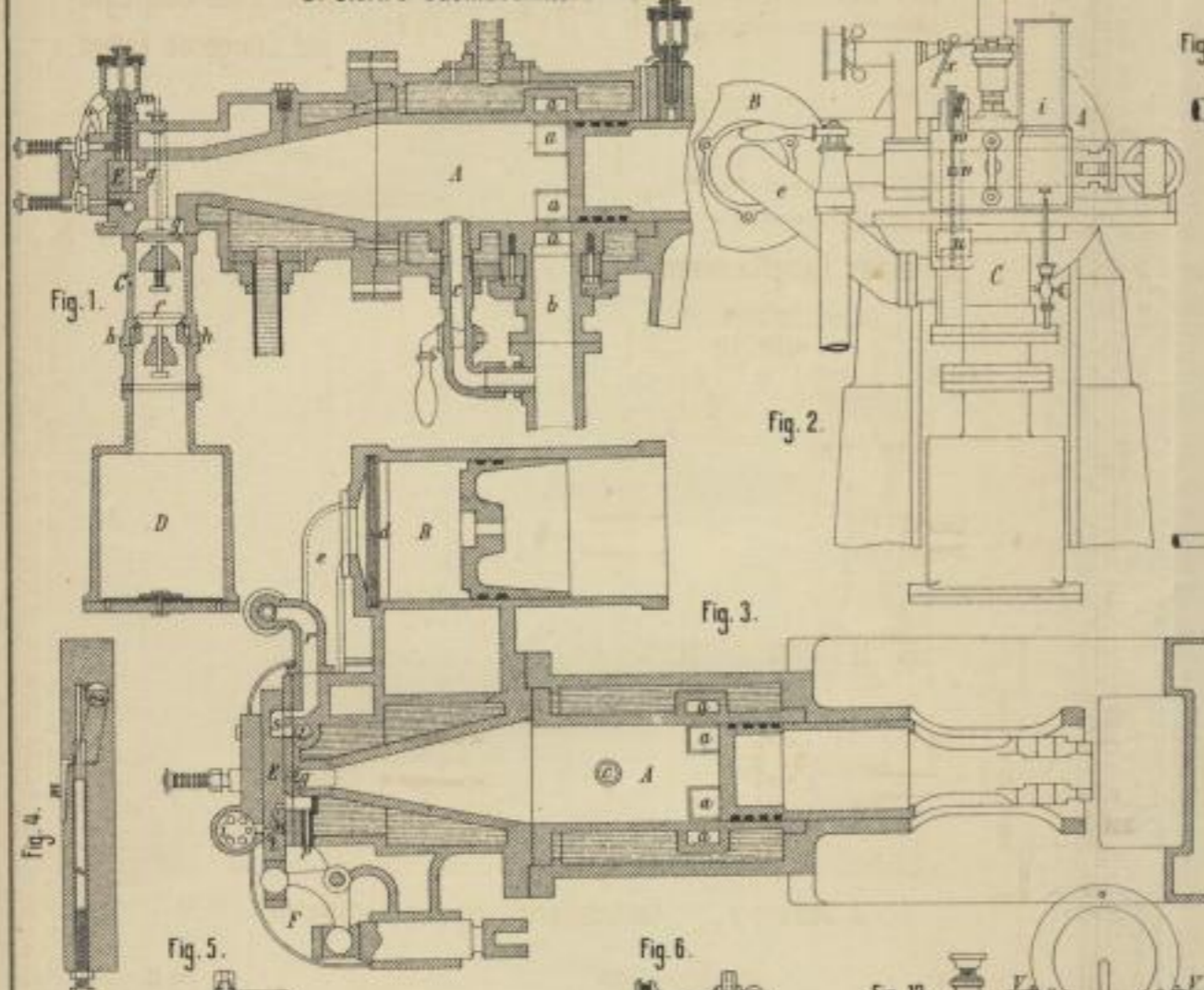
Lith. Anst. v. F. Wirtz, Darmstadt.



Zeich. von J. W. W. W. W. W.

Neuerungen an Gasmaschinen. (Taf. 9, 12 u 13.)

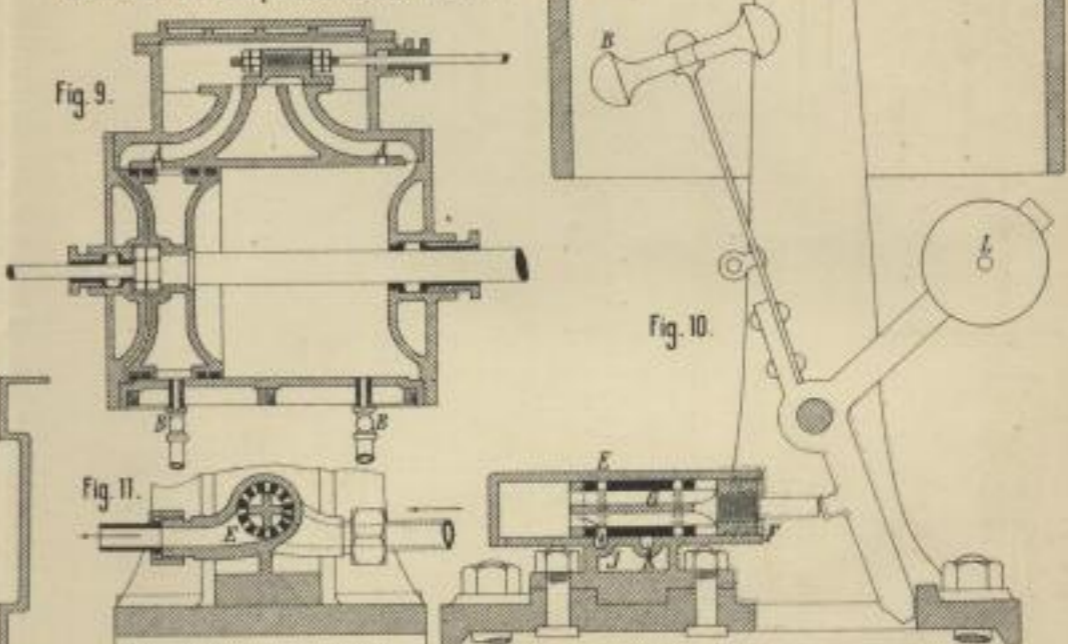
D. Clerk's Gasmaschine. (1-4)



Bolton's bez. Geoghegan und Sturgeon's Kolben. (7-8,9)



Schichau's Dampfbläutwerk. (10 u 11)



J. Johann's Kesselausrüstung für Locomotiven. (12-17)

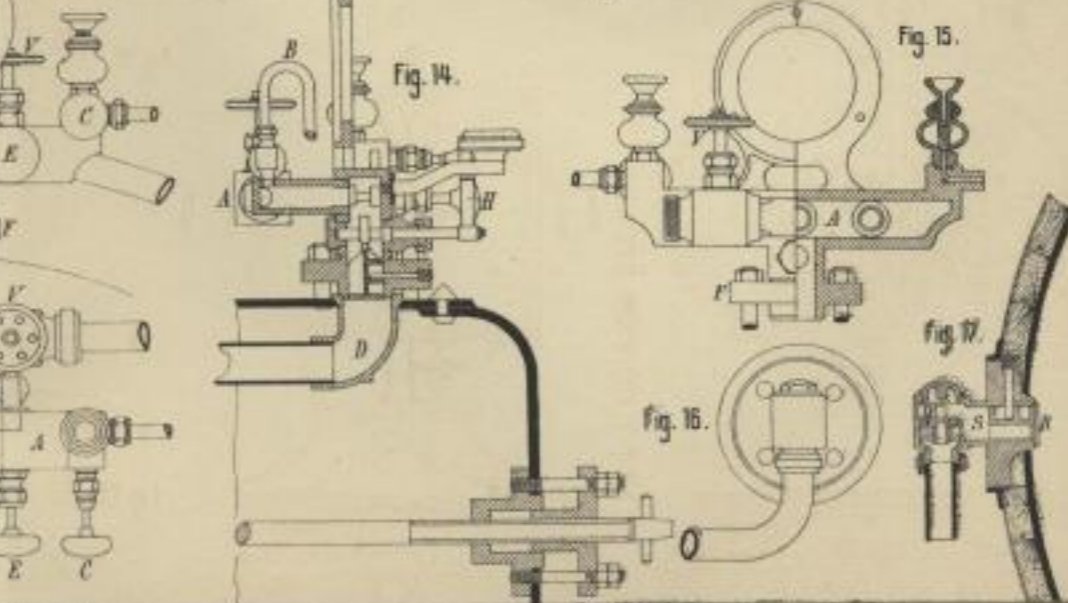
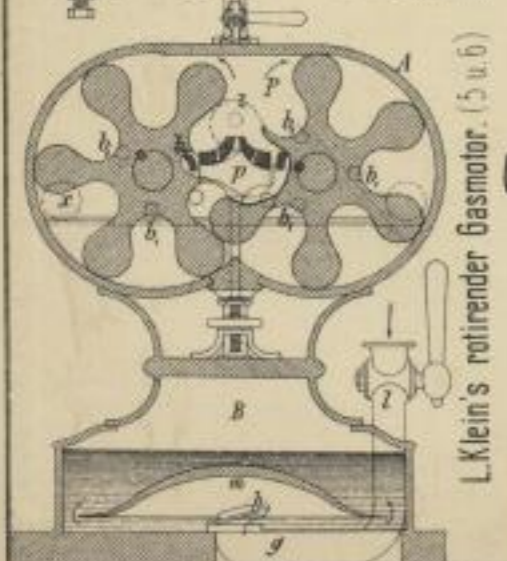
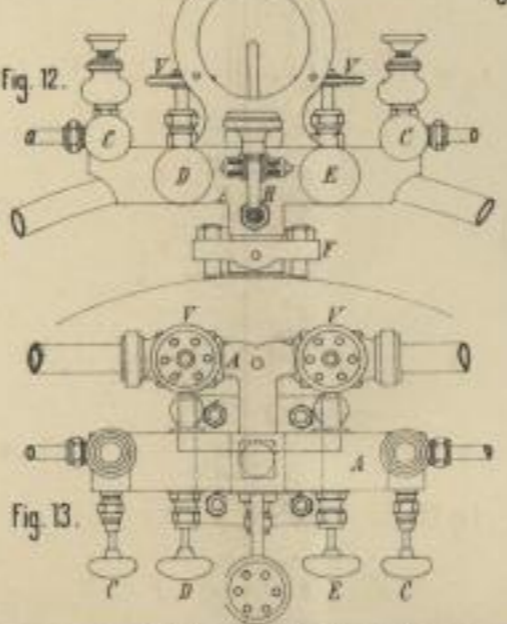
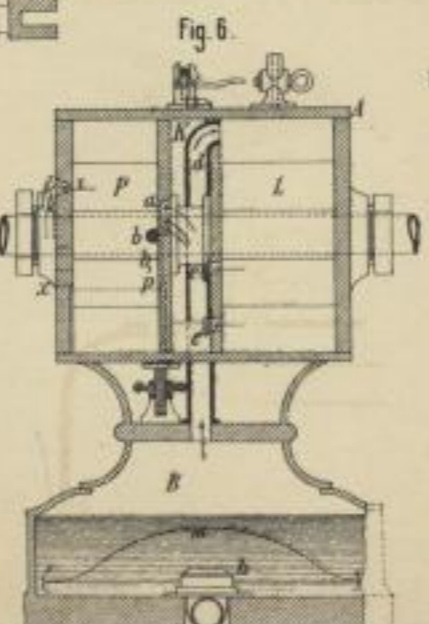


Fig. 5.

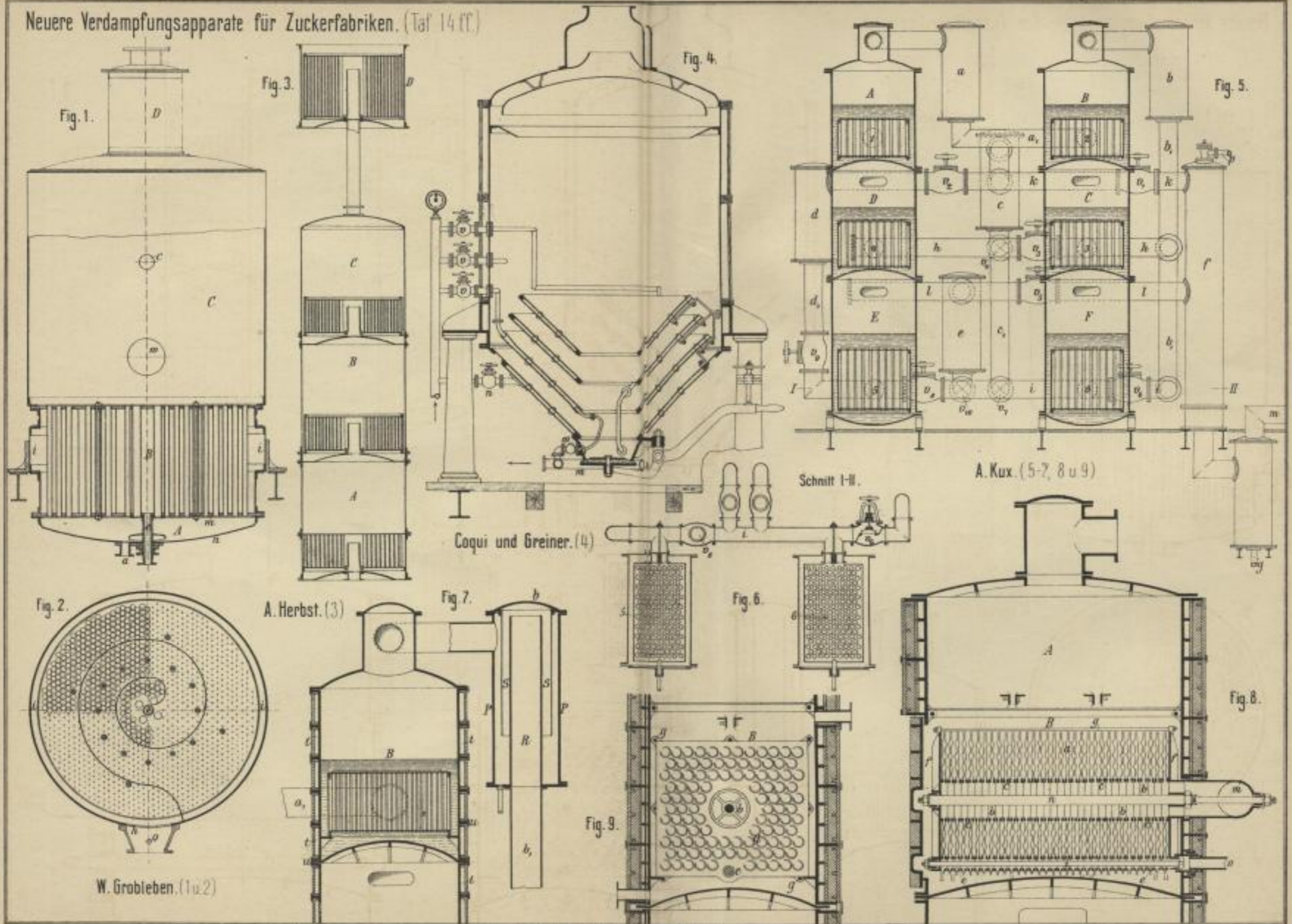


L. Klein's rotirender Gasmotor. (5 u. 6)

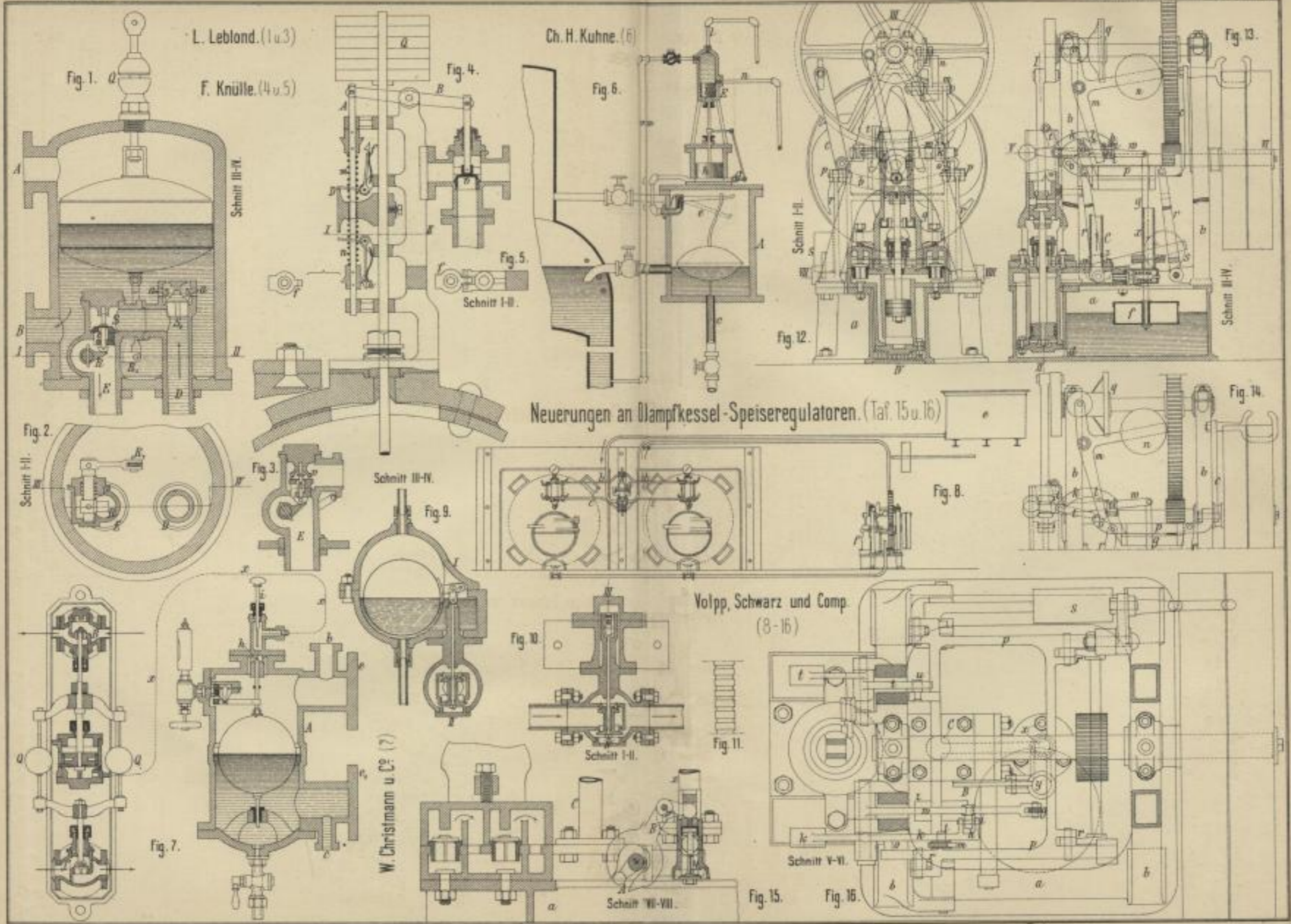


Lith. Anst. v. F. Metz, Darmstadt.

Neuere Verdampfungsapparate für Zuckerfabriken. (Taf. 14 ff.)



Lith. Anst. v. F. Moriz, Darmstadt



Neuerungen an Dampfkessel-Speiseregulatoren. (Taf. 15 u. 16)

Volpp, Schwarz und Comp. (8-16)

W. Christmann u. Co. (?)

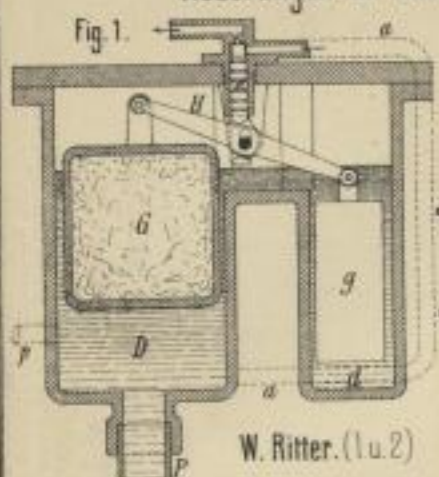
Lebh. Anst. v. F. Wirtz, Darmstadt

Neuerungen an Dampfkessel-Speiseregulatoren. (Taf. 15 u. 16)

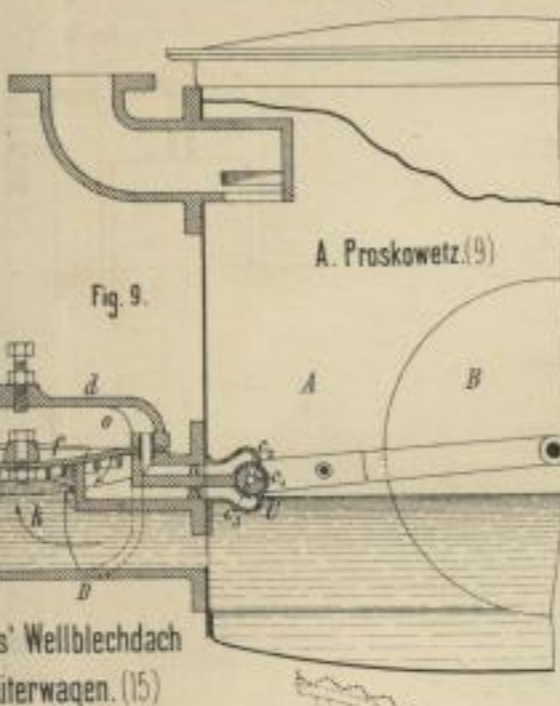
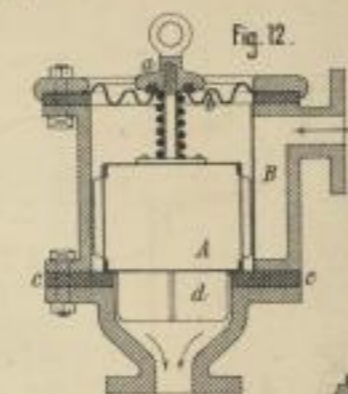
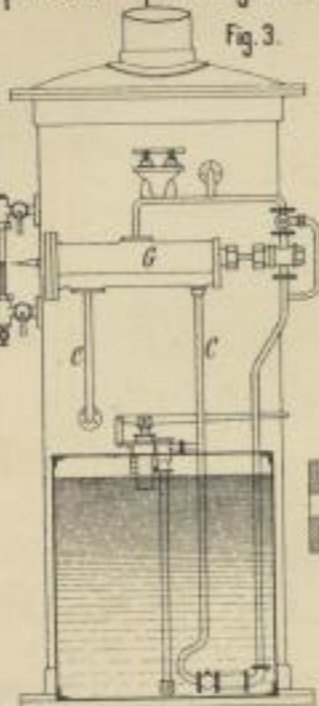
C. Chuwab. (12)

Neuerungen an Condensationswasser-Ableitern (8-13)

D. Edwards. (10 u. 11)



W. Ritter. (1 u. 2)



A. Proskowetz. (9)

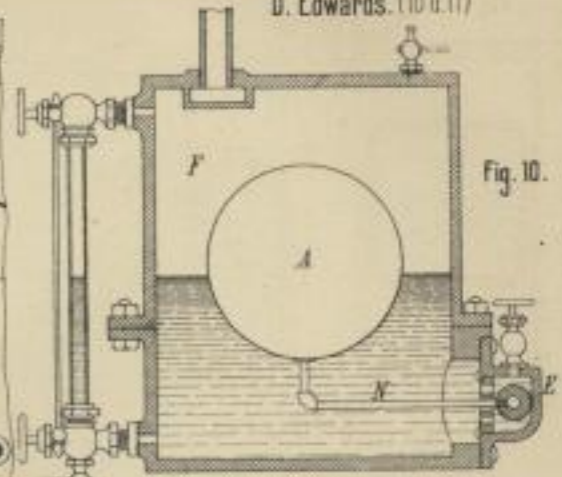


Fig. 10.

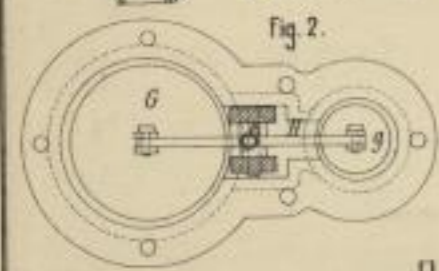


Fig. 2.

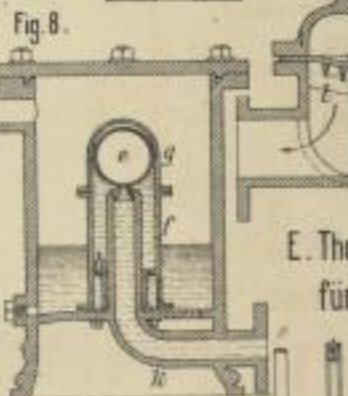


Fig. 8.

E. Thomas' Wellblechdach für Güterwagen. (15)

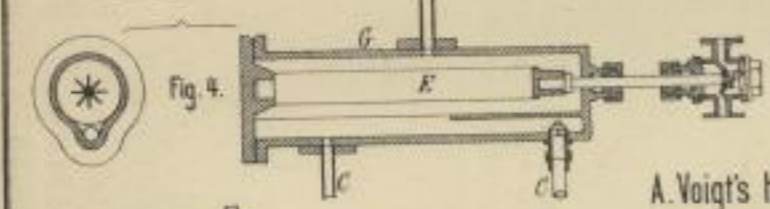
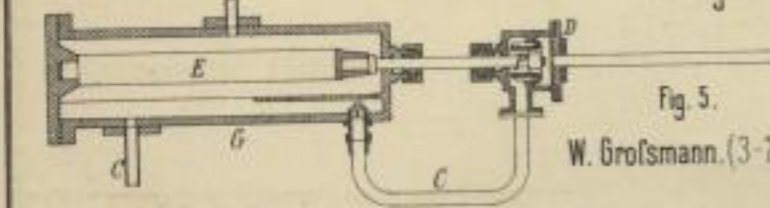


Fig. 4.

H. Meyer. (8)



W. Großmann. (3-7)

Fig. 14.

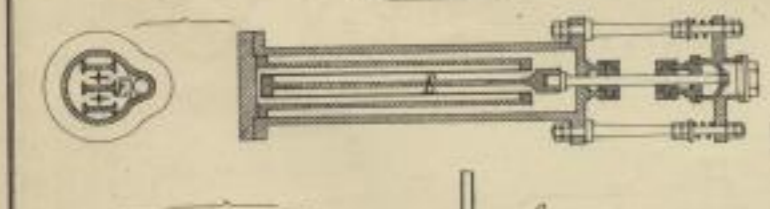


Fig. 6.

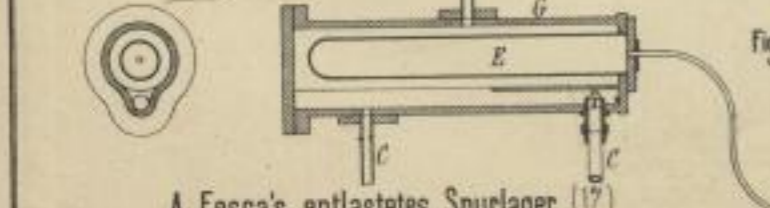


Fig. 7.

A. Fesca's entlastetes Spurlager. (17)

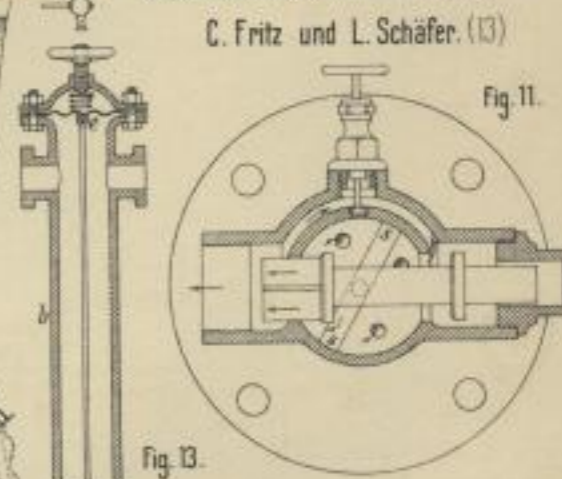
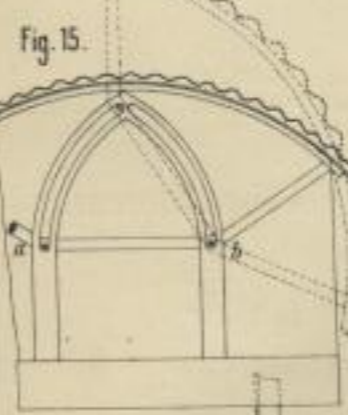
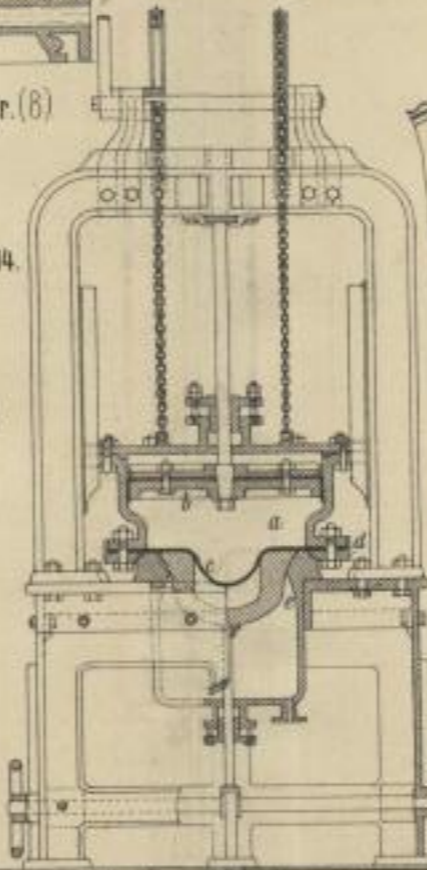


Fig. 11.

C. Fritz und L. Schäfer. (13)

Randall's Saugkasten. (16)

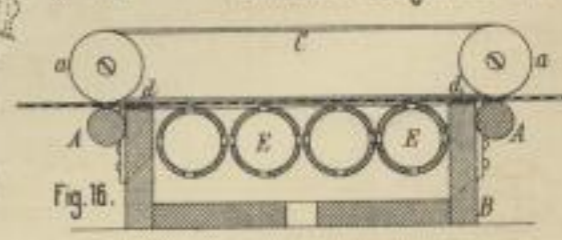


Fig. 16.

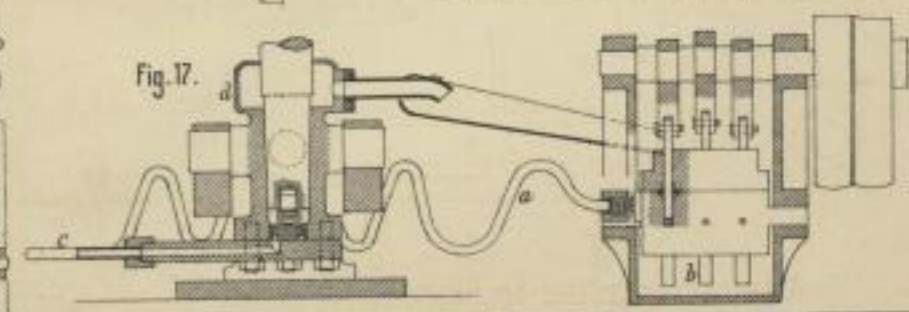
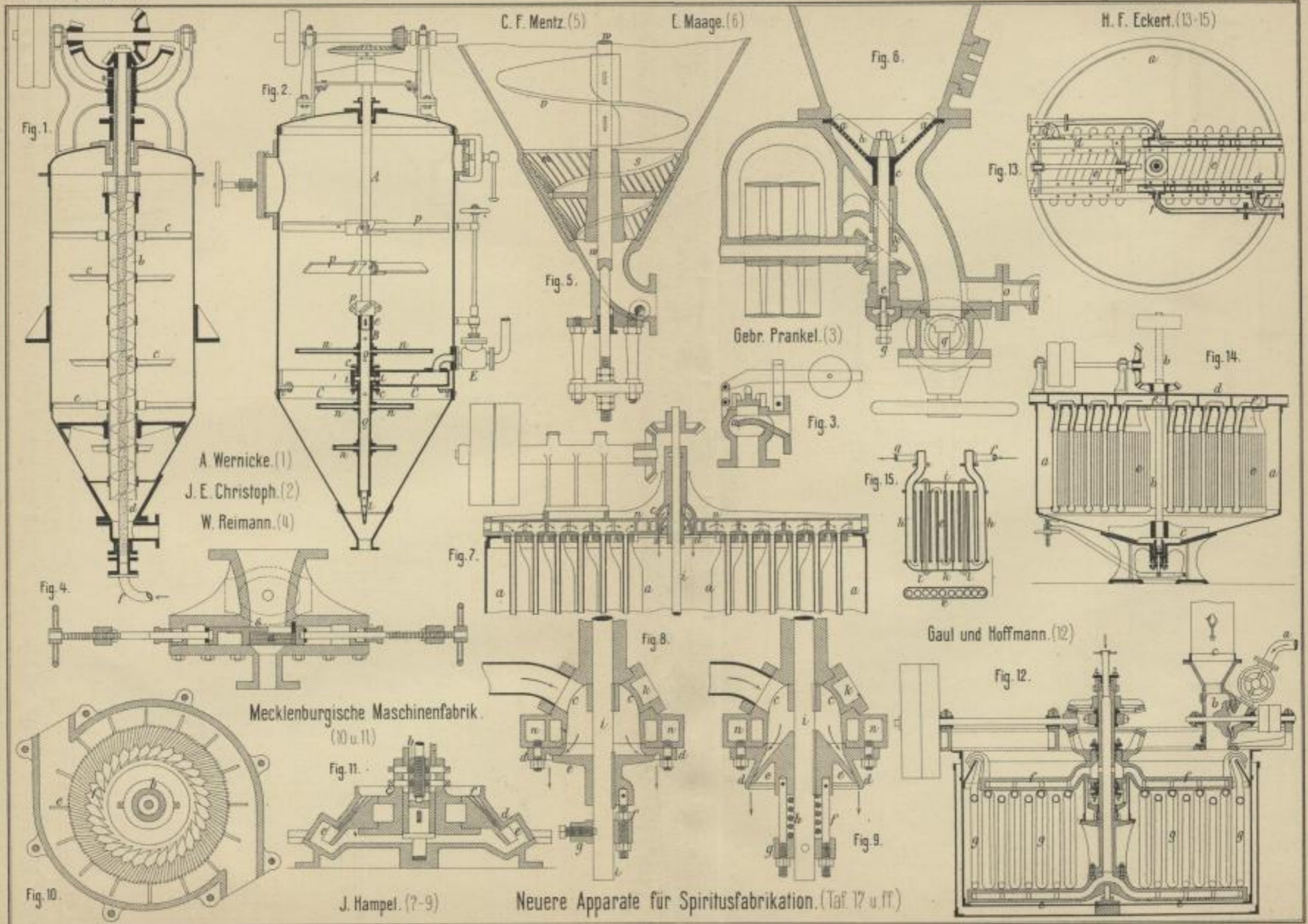


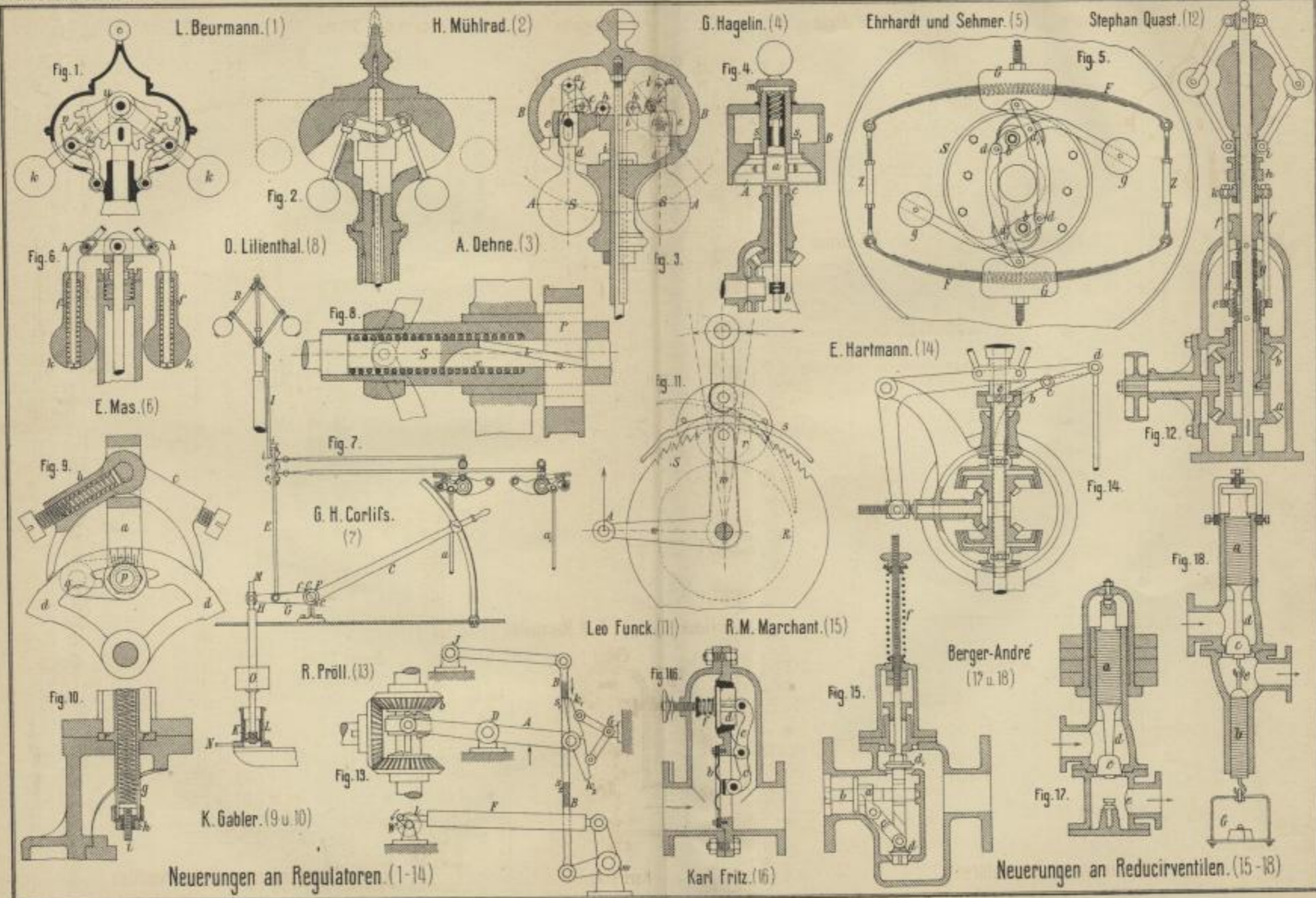
Fig. 17.

Lith. Anst. v. F. Witz, Darmstadt.



Neuere Apparate für Spiritusfabrikation. (Taf. 17 u. 18.)

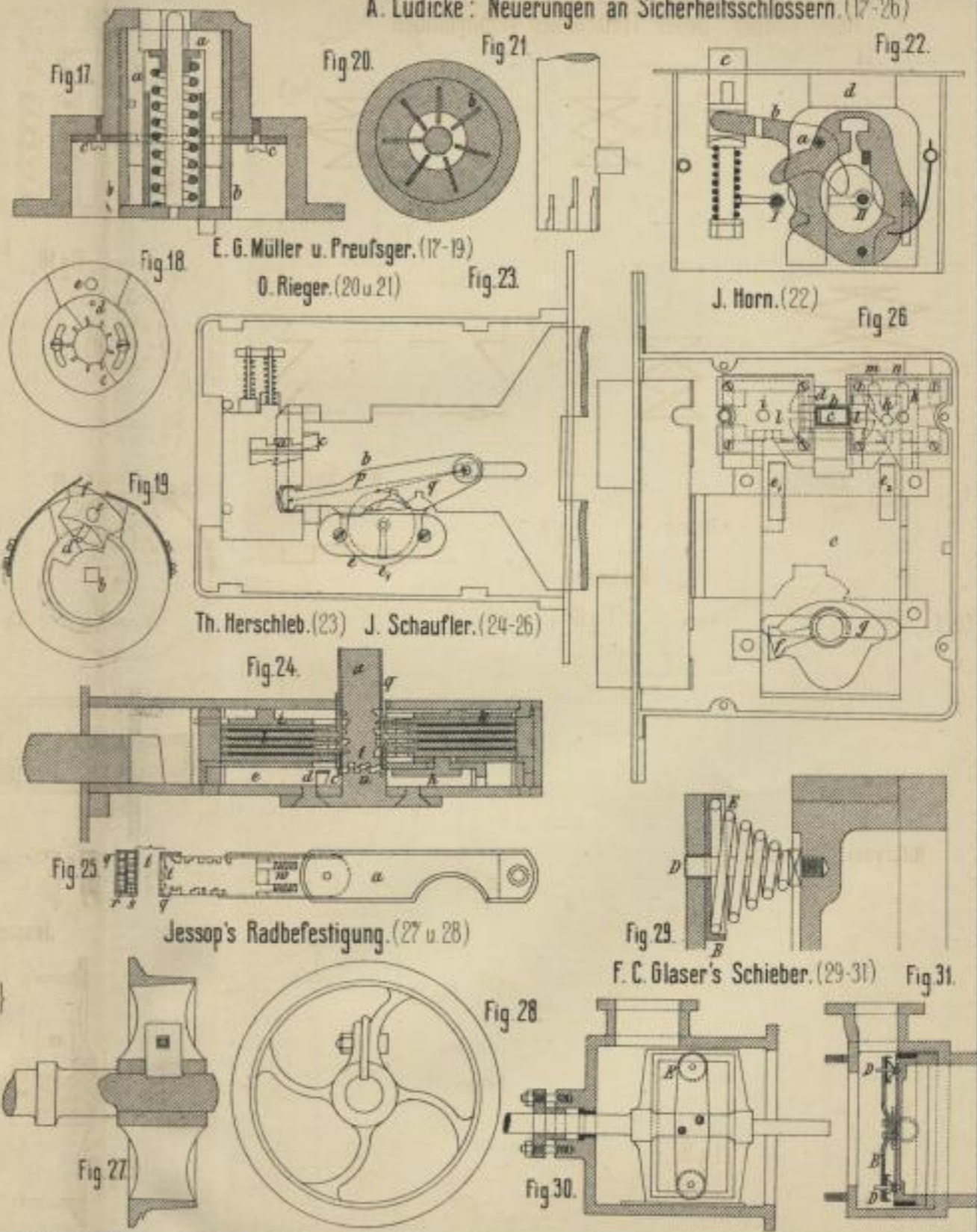
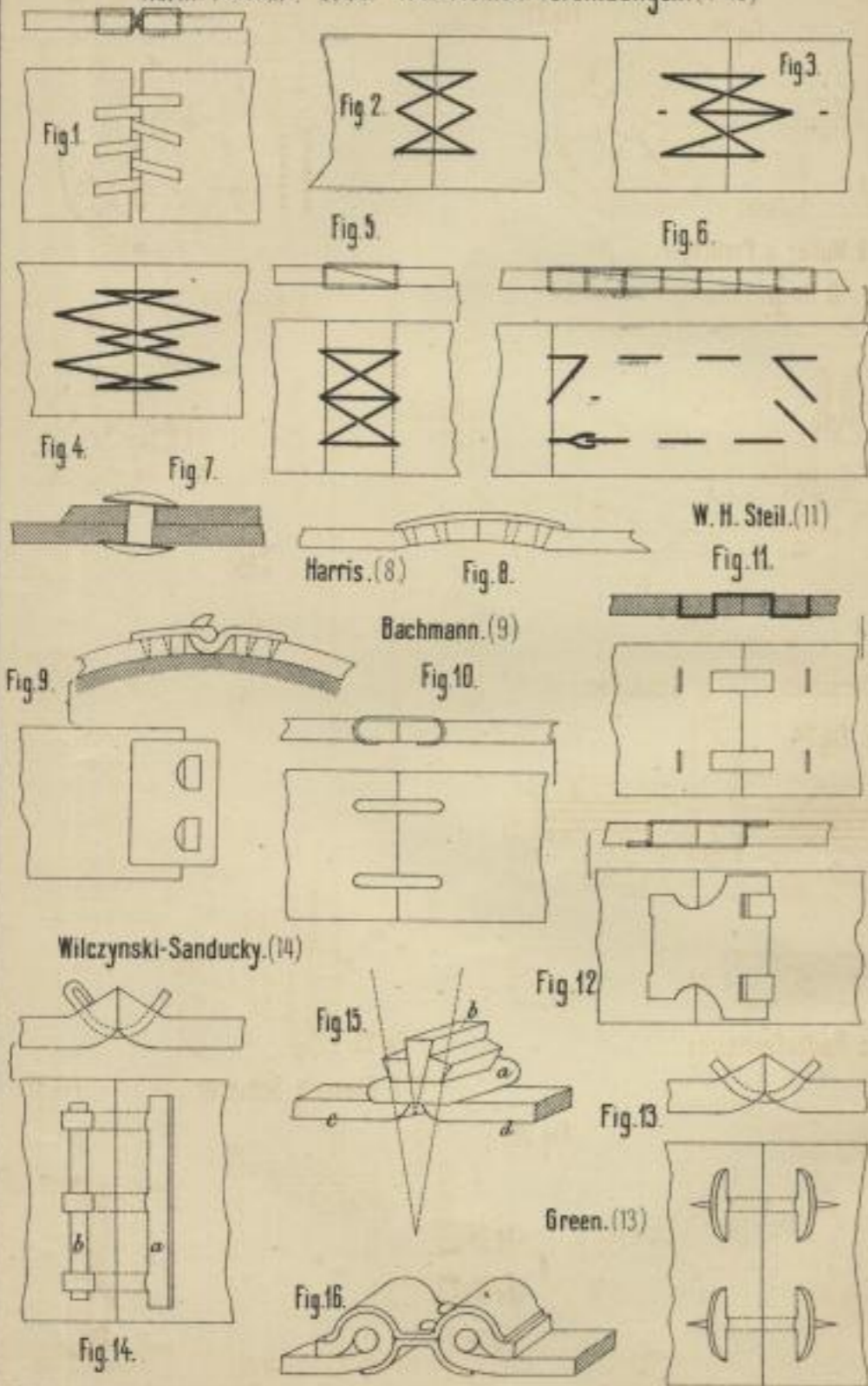
lith. Anst. v. F. Witz, Darmstadt



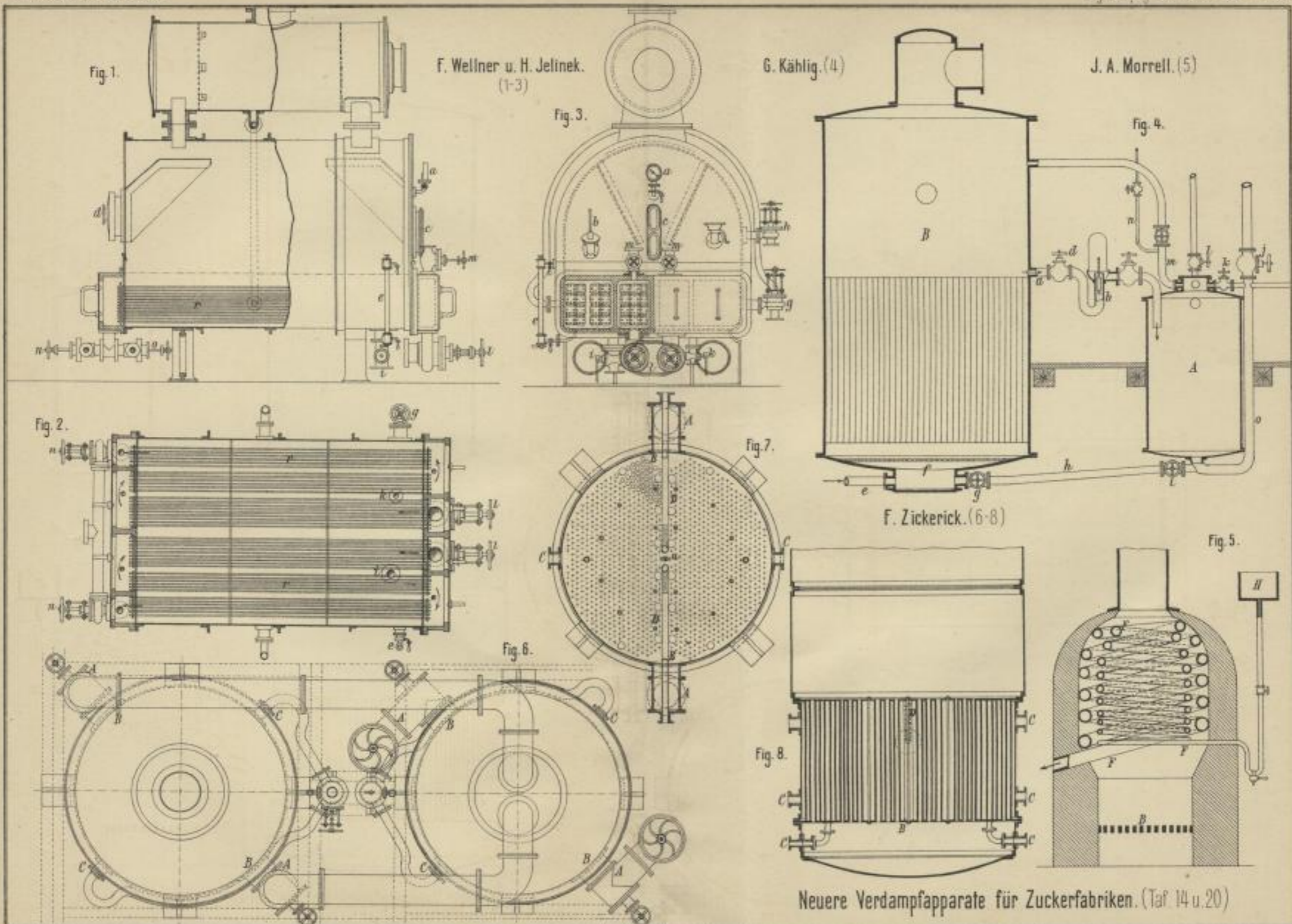
Lith. Anst. v. F. Werra, Jena

Herm. Fischer: Ueber Treibriemen-Verbindungen. (1-16)

A. Lüdicke: Neuerungen an Sicherheitsschlössern. (17-26)



Lith. Anst. v. P. Wirtz, Darmstadt.



Lith. Anst. v. F. Wirtz, Darmstadt.

Dampfmaschinen-Steuerungen mit zwei einfachen Muschelschiebern. (Taf. 21 u. 24.)

H. Lehmann. (1-3.)

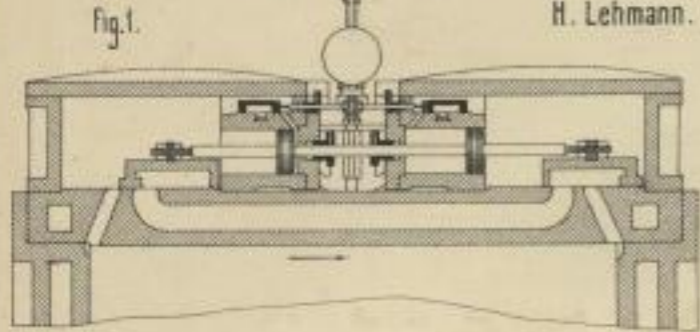


Fig. 1.

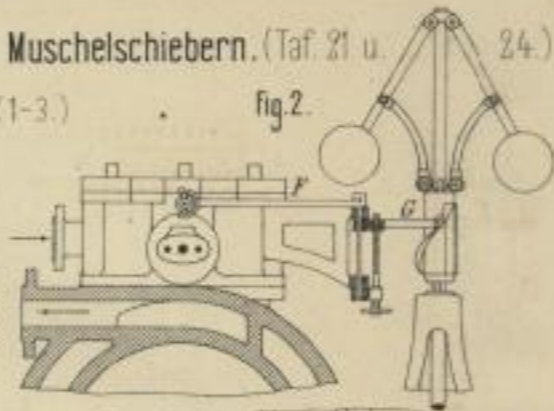


Fig. 2.

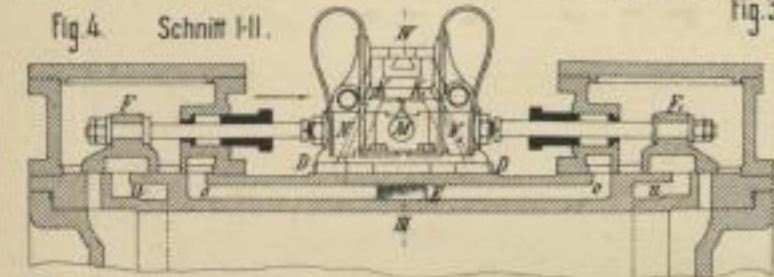


Fig. 4. Schnitt III.

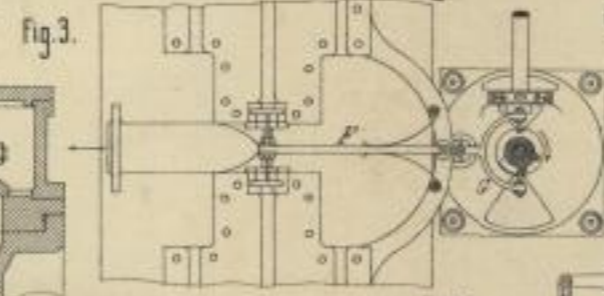


Fig. 3.

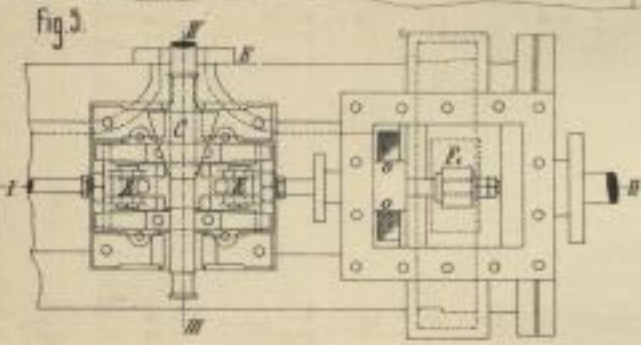


Fig. 5.

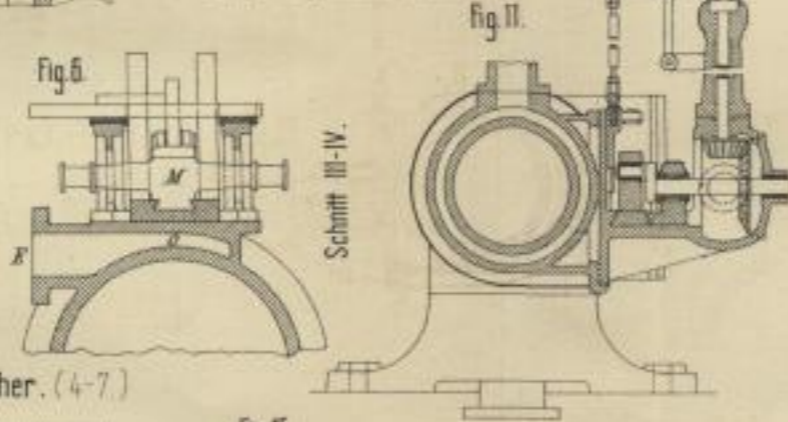


Fig. 6.

Schnitt III-IV.

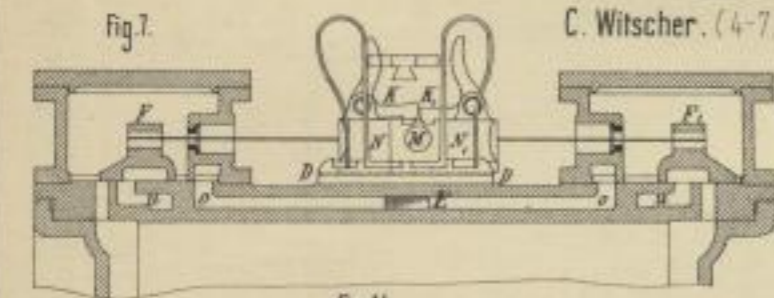


Fig. 7.

C. Witscher. (4-7.)



Fig. 13.

Fig. 14.

C. Gamper's Flammrohrkessel. (13-17.)

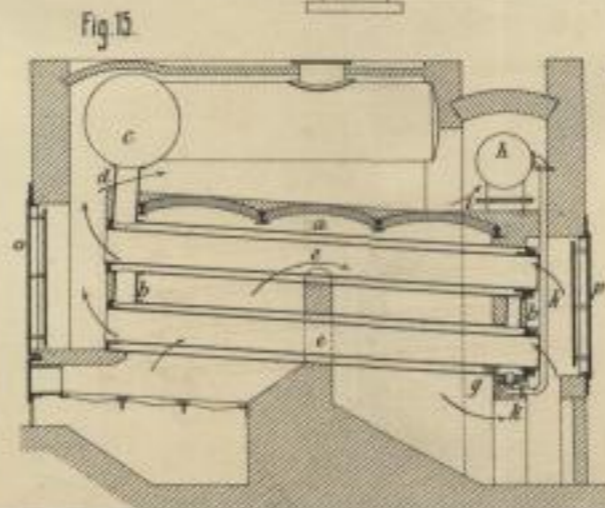


Fig. 15.

Fig. 16.

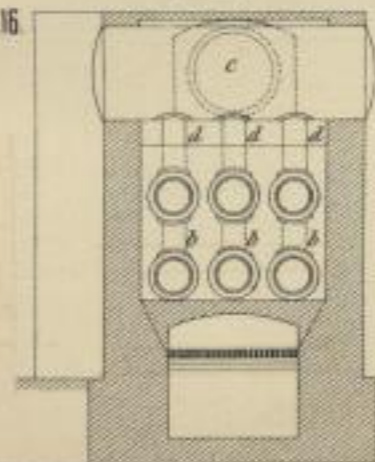


Fig. 17.

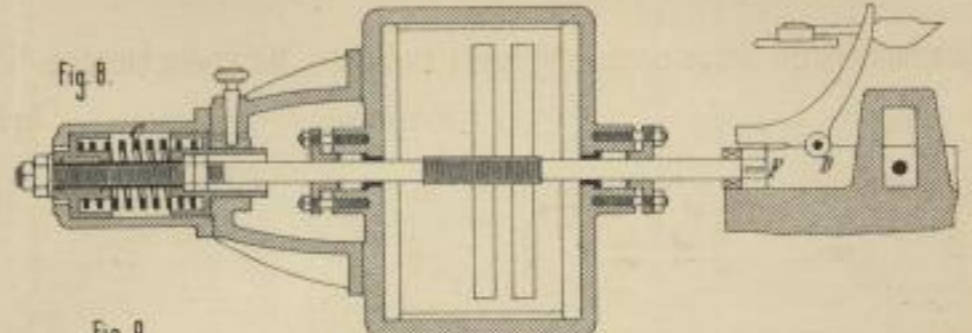
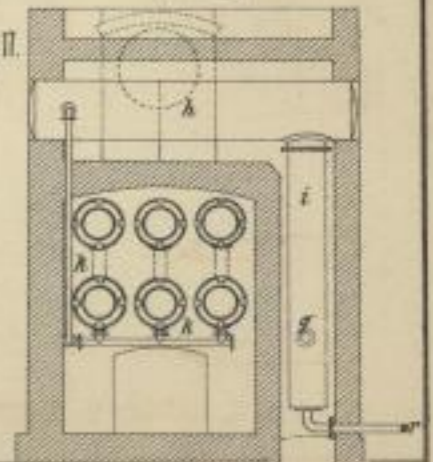


Fig. 8.

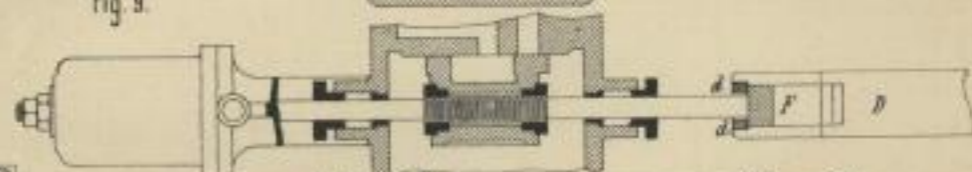


Fig. 9.

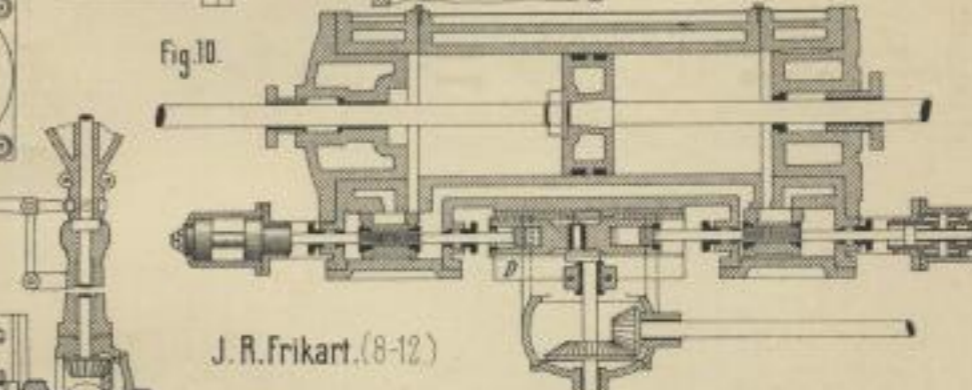


Fig. 10.

J. R. Frikart. (8-12.)

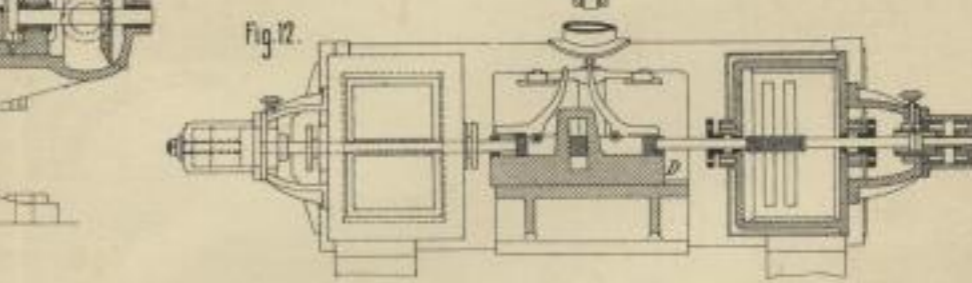
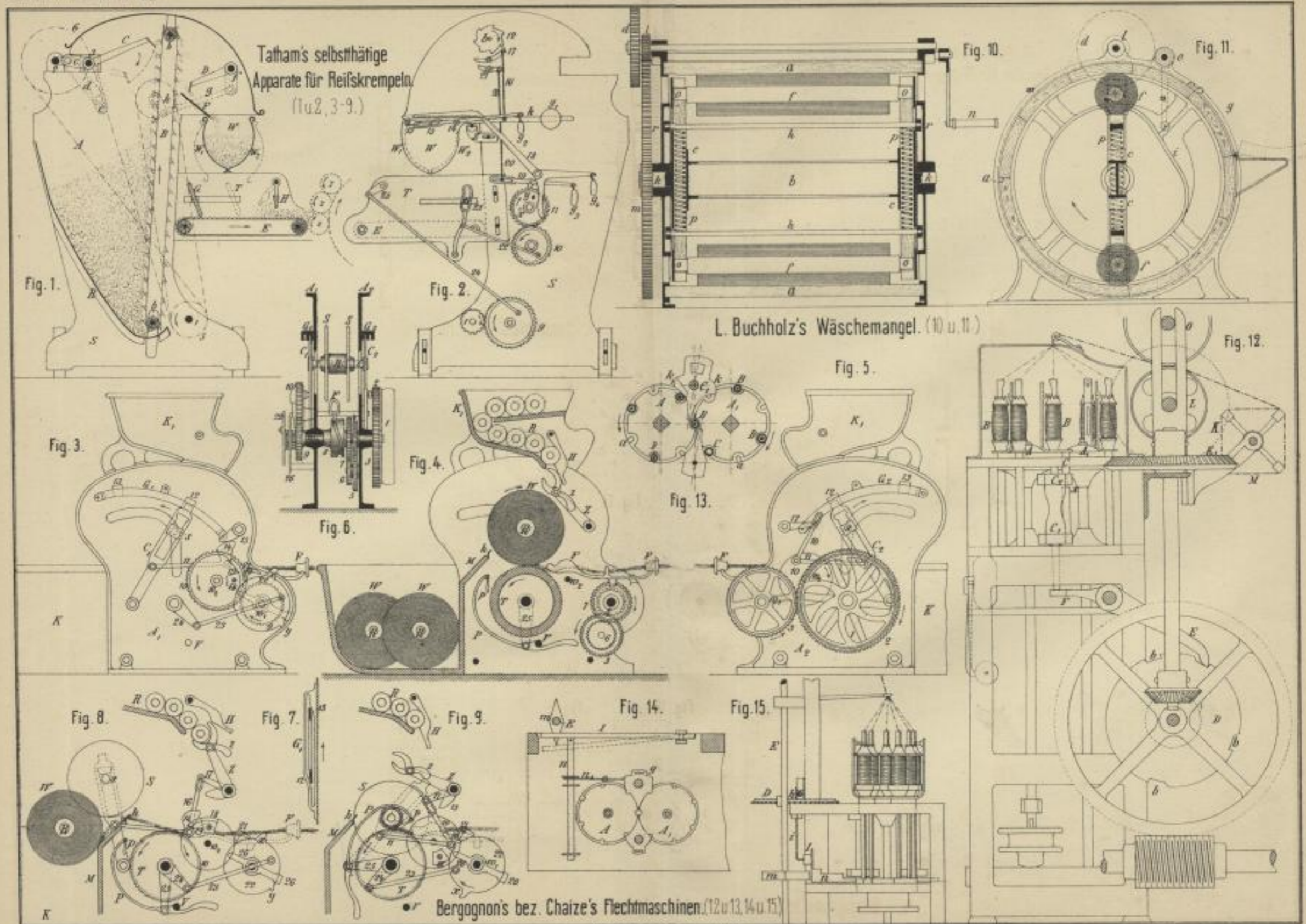


Fig. 12.

Lith. Anst. v. F. W. Metz, Bamberg.



Lib. Aut. v. J. Wirs, Darmstadt

Fig. 1.

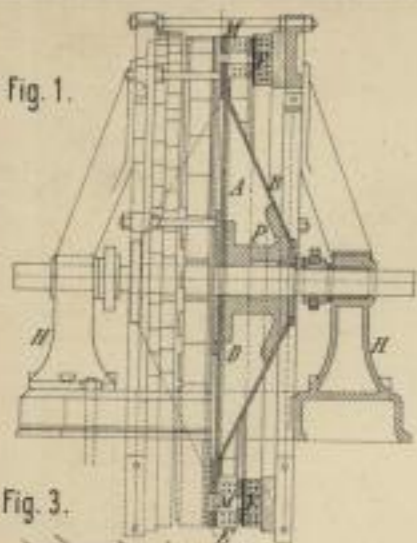


Fig. 2.

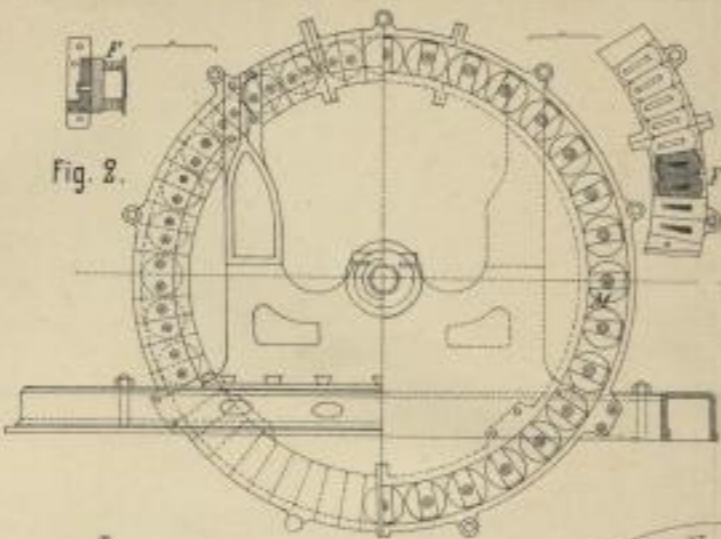


Fig. 4.

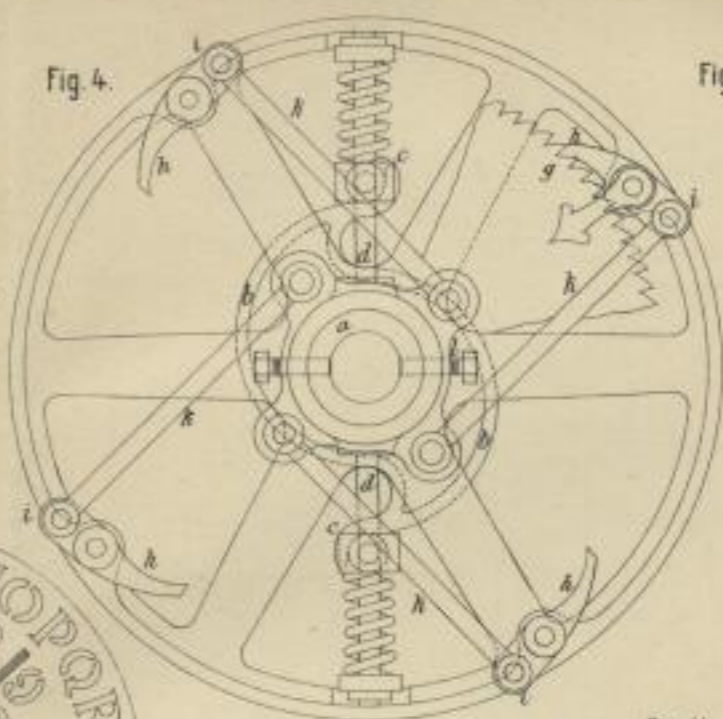


Fig. 5.

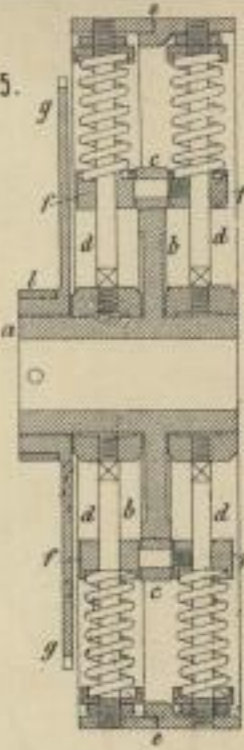
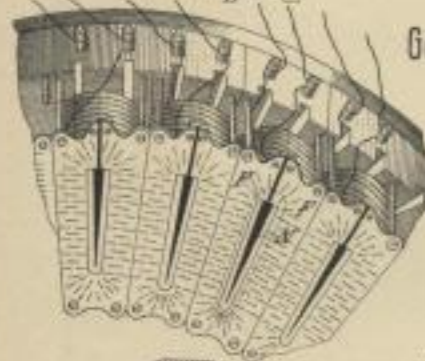


Fig. 3.



Gordon's magnetelektrische Maschine. (1-3)

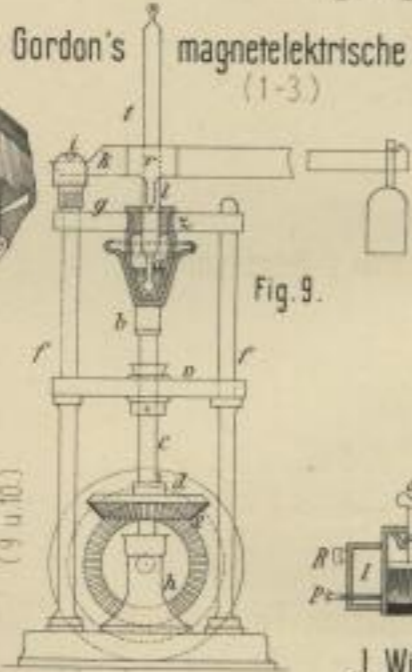
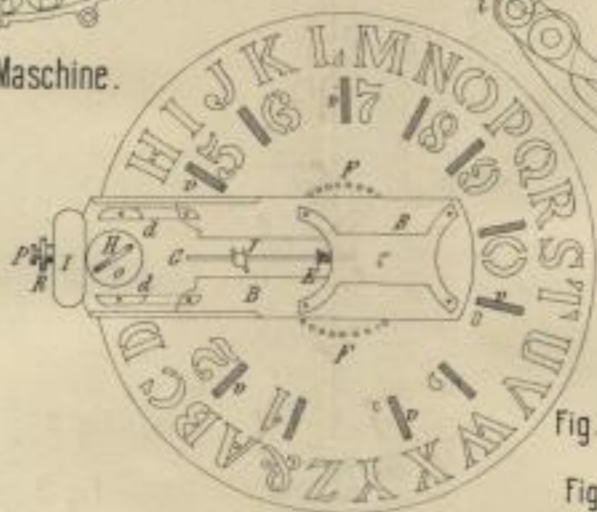


Fig. 9.



J. Williamson's Schablonenplatte. (11 u. 12.)



Fig. 12.

Klumak's Repetiruhr. (13 u. 14.)

Fig. 11.

Fig. 13.

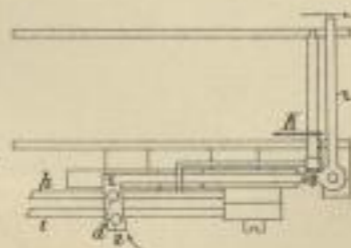
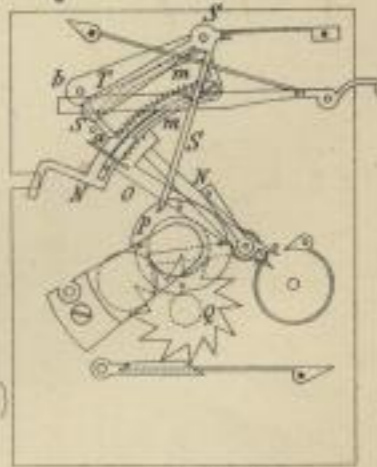


Fig. 14.

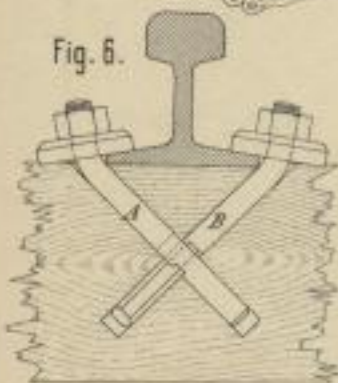


C. Schäfer's Braupfannen-Einmauerung. (15-17)

Schnitt III-IV.

Schnitt V-VI.

Fig. 6.



E. Willigk's Prüfung von Schmiermitteln. (9 u. 10.)



Fig. 10.

Fig. 15.

Fig. 16.

Fig. 17.

Fig. 7.

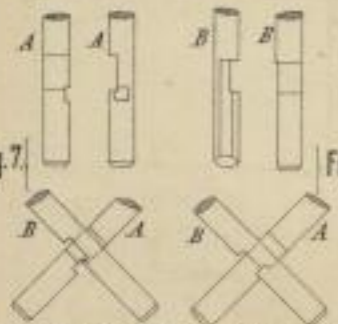


Fig. 8.

Th. J. Bush's Schienenbolzen. (6-8)

Verf. durch F. Witzmann, Berlin.

Dampfmaschinen-Steuerungen mit zwei

einfachen Muschelschiebern.

(Taf. 21 u. 24.)

M. A. Starke. (1-10.)

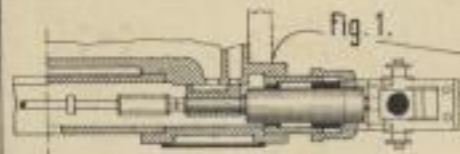


Fig. 1.

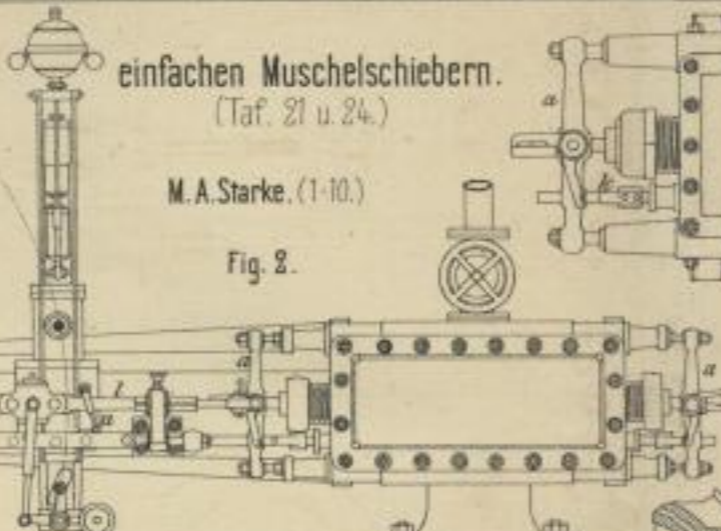


Fig. 2.

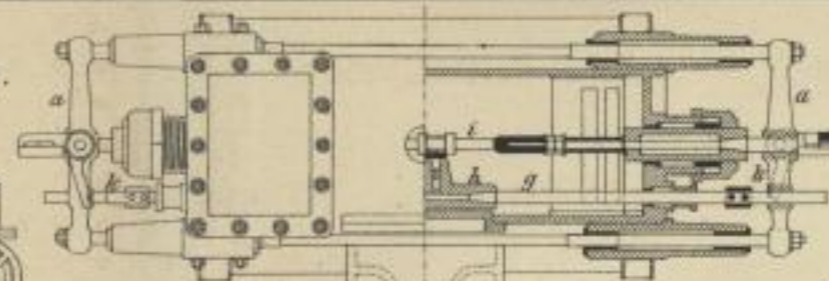


Fig. 4.

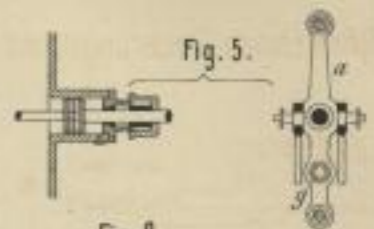


Fig. 5.

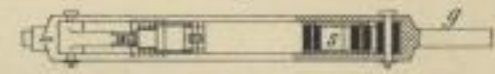


Fig. 8.



Fig. 9.



Fig. 10.

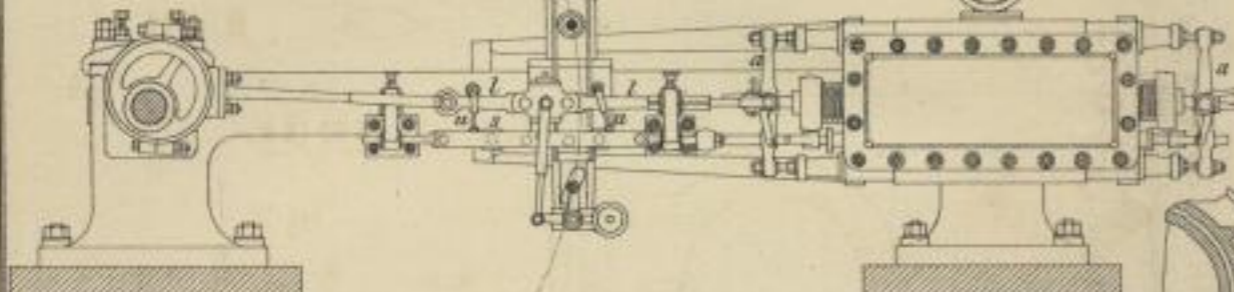


Fig. 3.

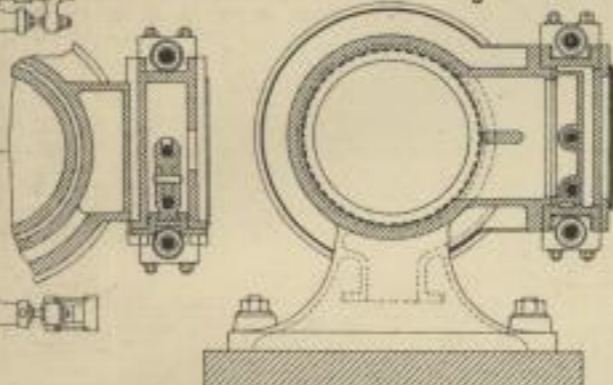


Fig. 6.

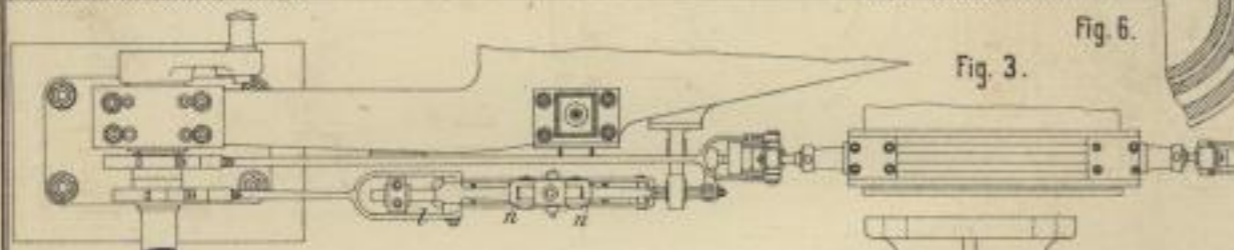


Fig. 11.

K. Chainoux. (13.)

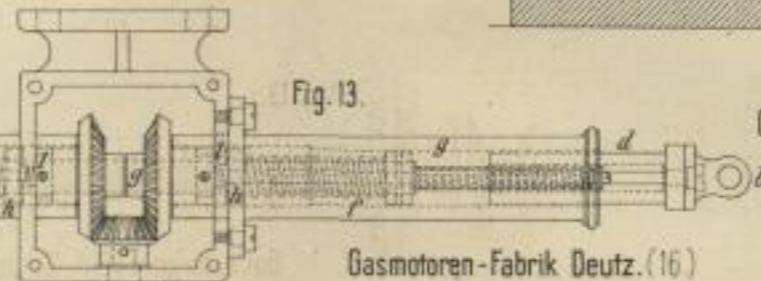


Fig. 13.

G. Pottle. (14.)

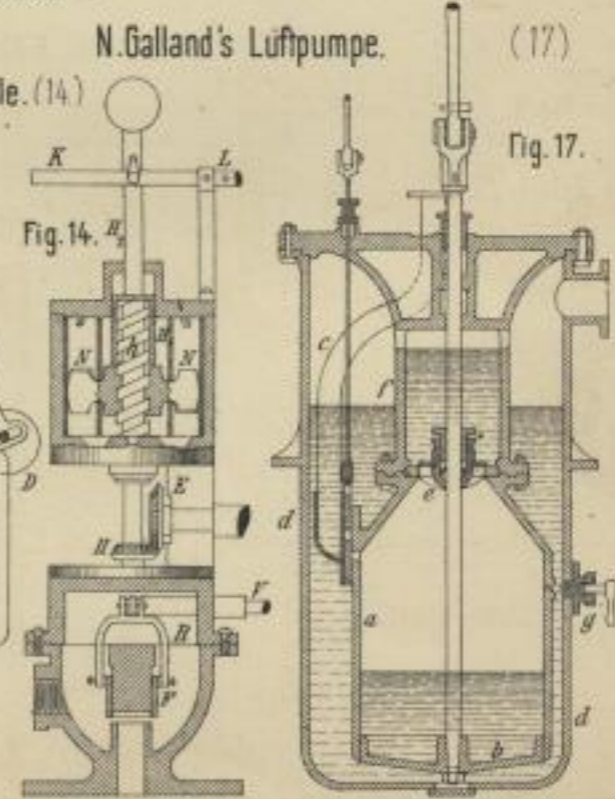


Fig. 14.

N. Galland's Luftpumpe. (17.)

Fig. 17.

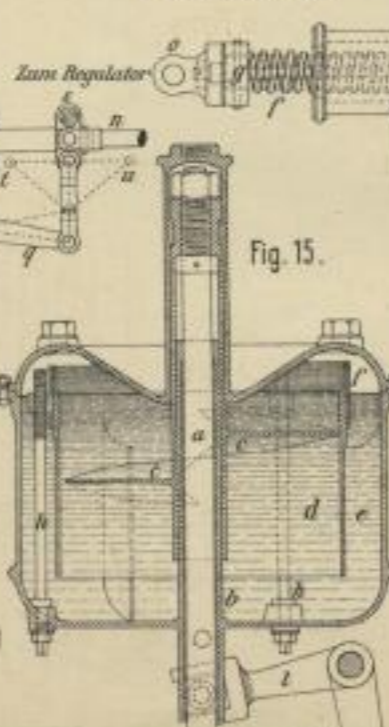


Fig. 15.

Gasmotoren-Fabrik Deutz. (16.)

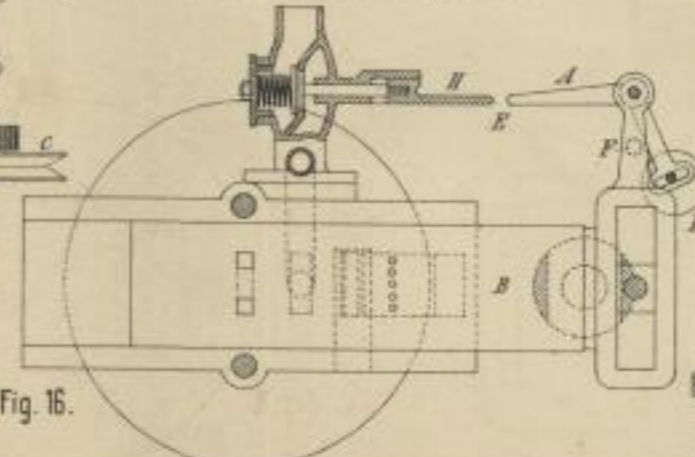


Fig. 16.

Neuerungen an Regulatoren. (Taf. 18 u. 24.)

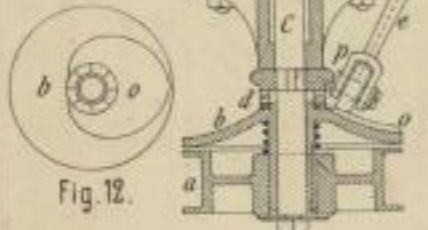


Fig. 12.

Steph. Quast. (11 u. 12.)

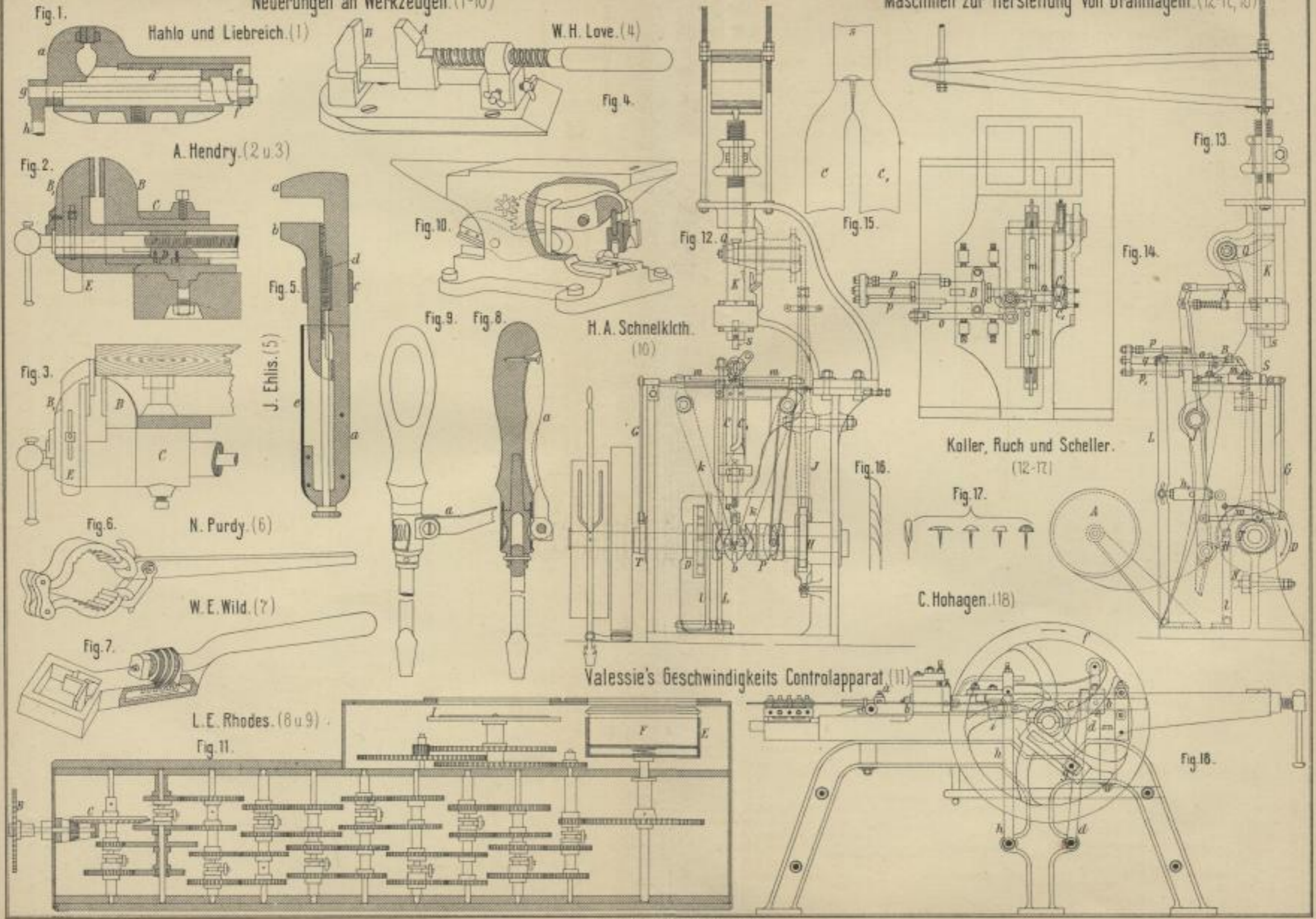
Eug. Schleh. (15.)

Lab. Inst. v. F. Wirtz, Darmstadt.

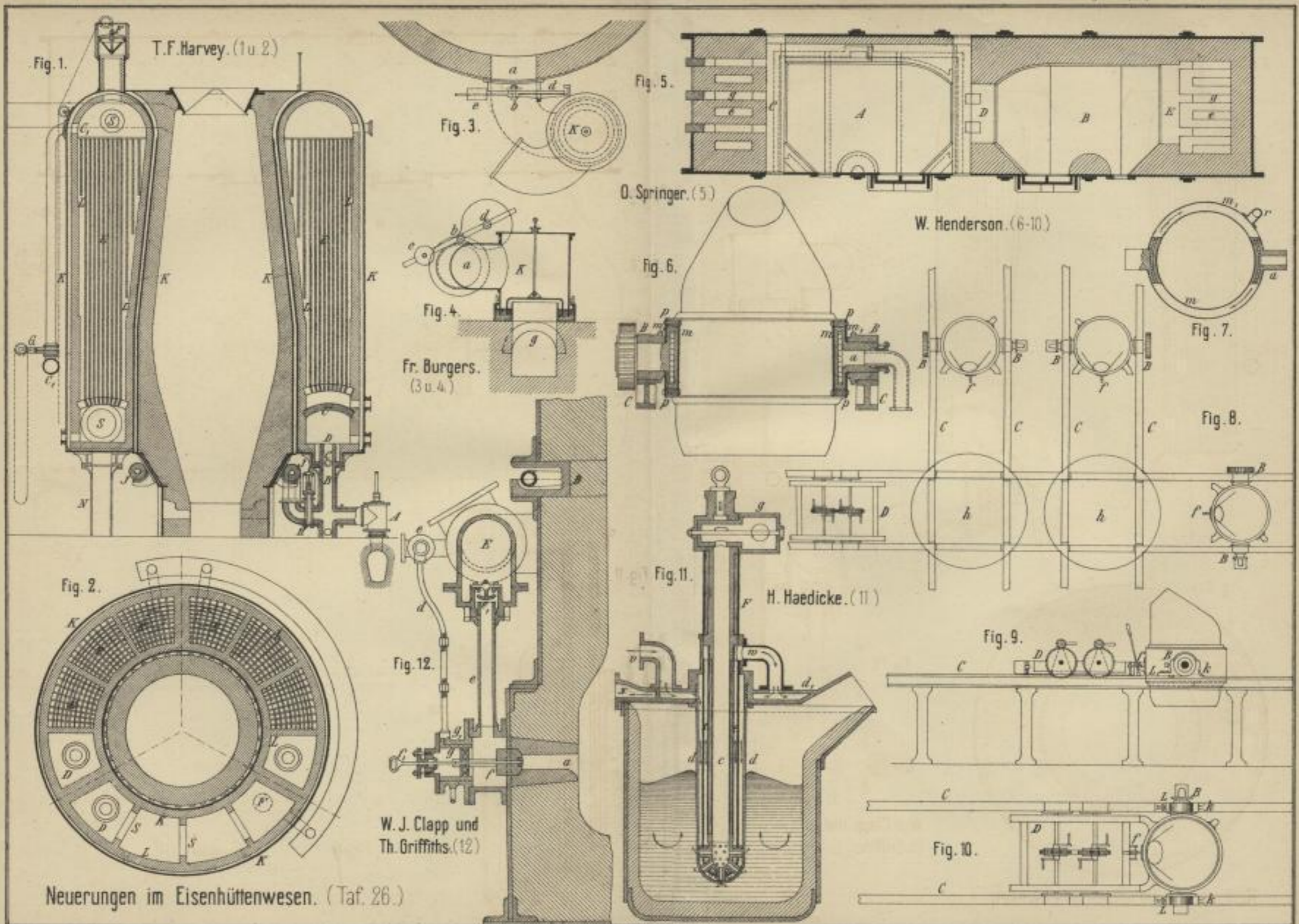


Neuerungen an Werkzeugen. (1-10)

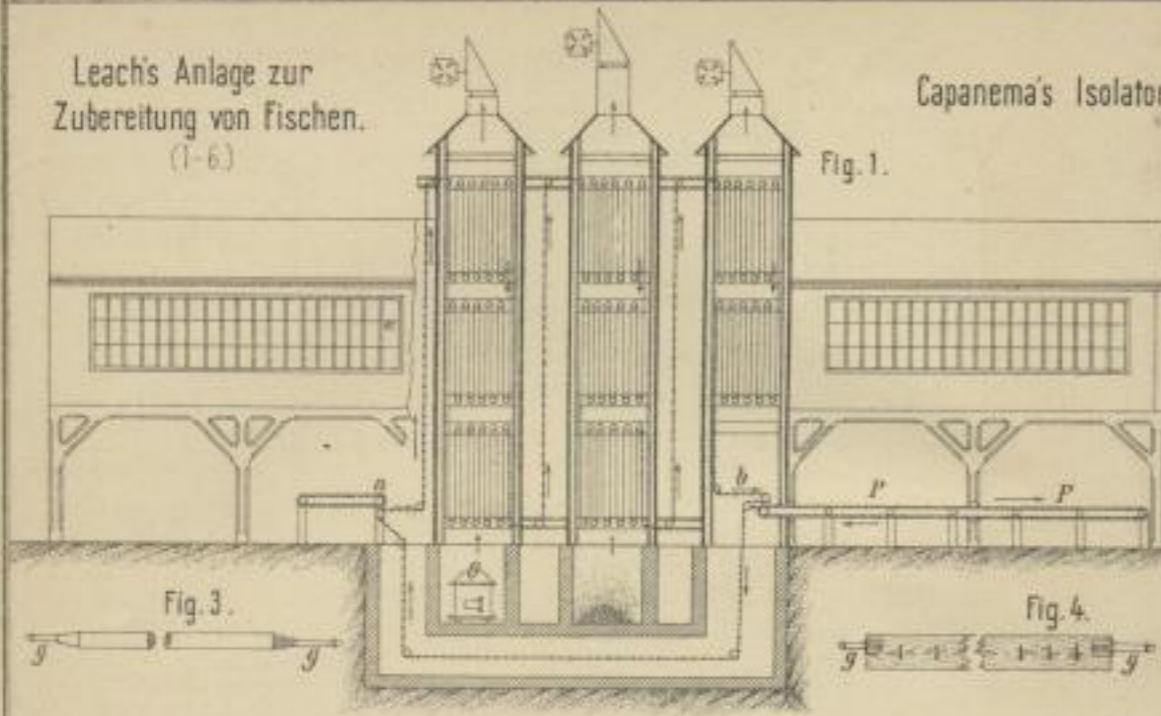
Maschinen zur Herstellung von Drahtnägeln. (12-17, 18)



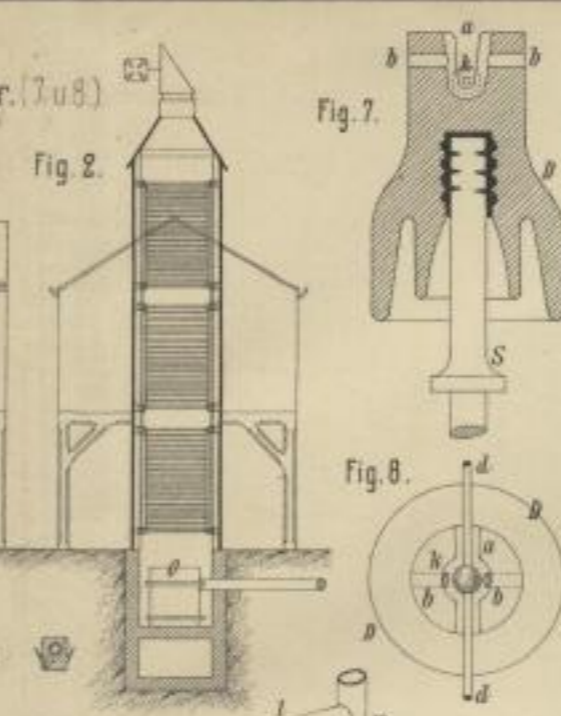
Arch. Anst. u. F. Wiese, Darmstadt.



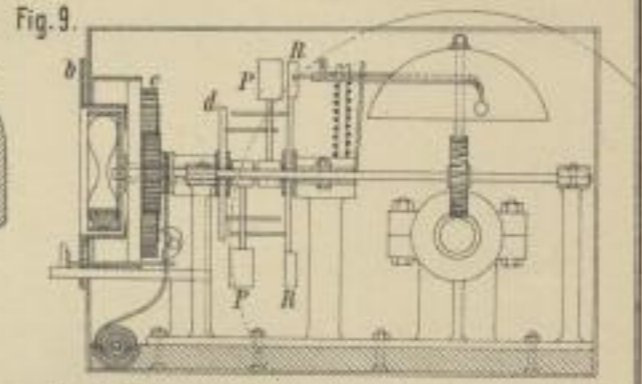
Leach's Anlage zur Zubereitung von Fischen. (1-6)



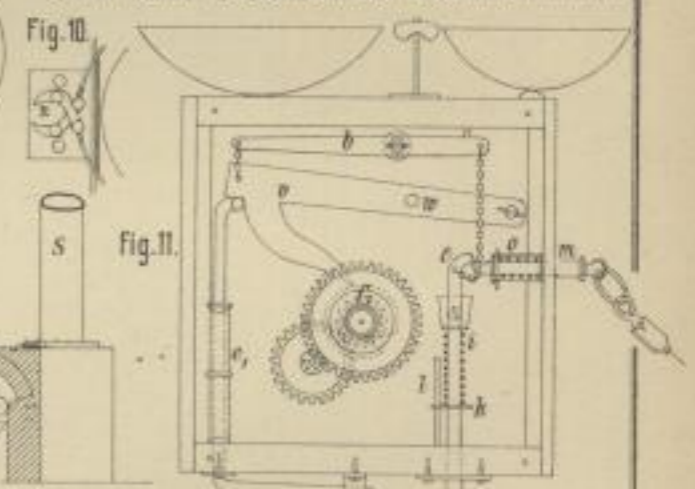
Capanema's Isolator. (7 u 8)



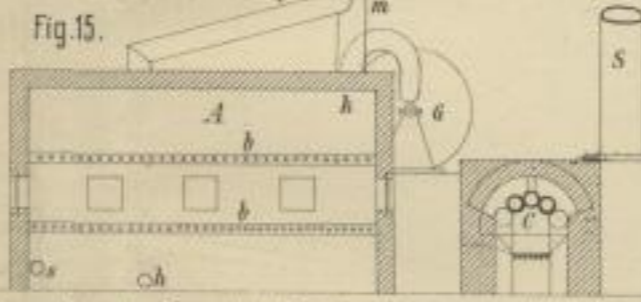
Hilden's Geschwindigkeitsmesser. (9 u 10)



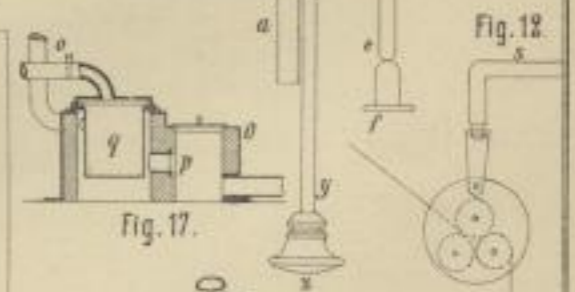
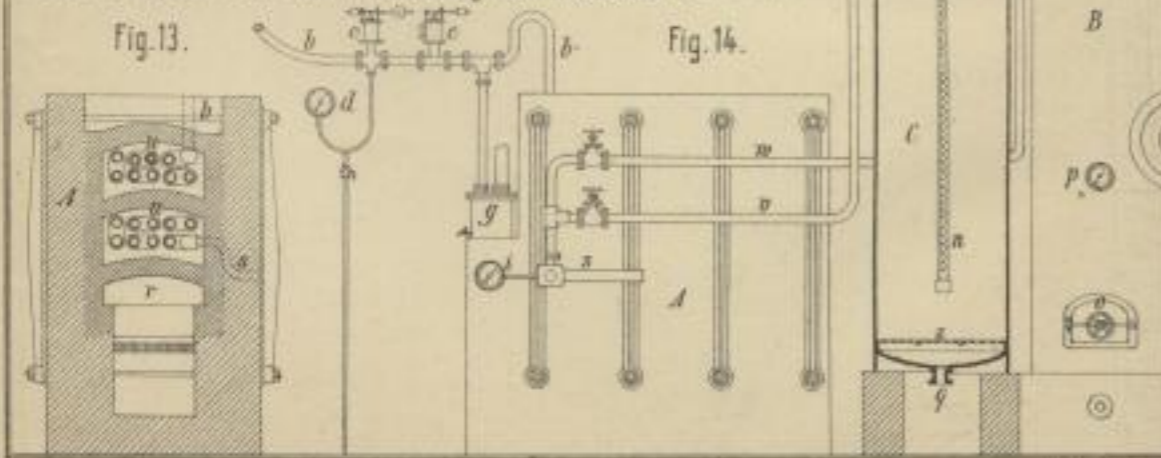
Oust. Fischer's Sicherheits-Weckeruhr. (11 u 12)



Kreusch und Emonds' Carbonisirapparat. (15-18)

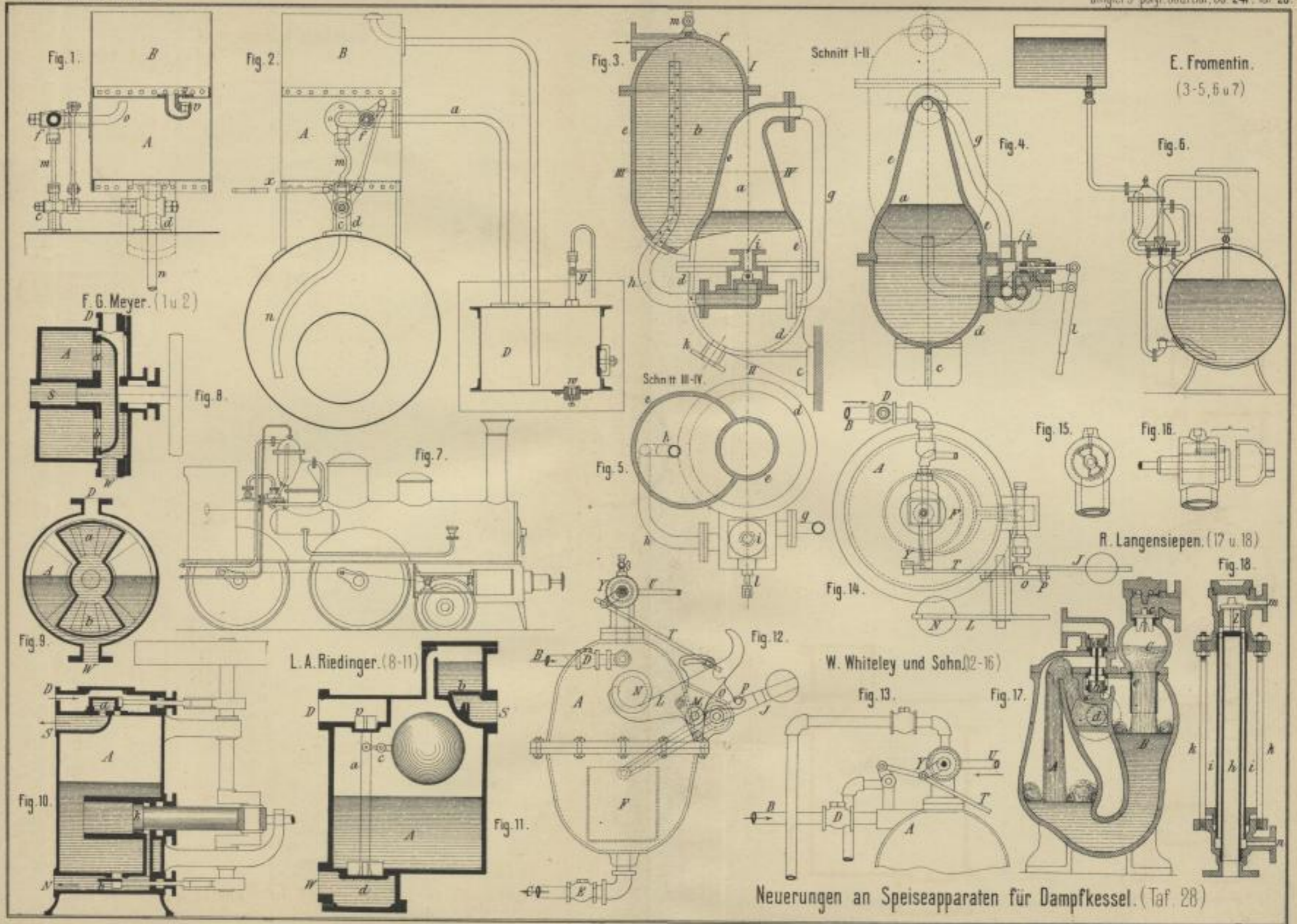


Höper's Apparat zur Wiederbelebung von Holzkohle. (13 u 14)



Lith. Anst. v. F. Wirtz, Darmstadt





Neuerungen an Speiseapparaten für Dampfkessel. (Taf. 28)

Lith. Anst. v. F. Wris, Darmstadt.

Neuere Wirkereimaschinen. (1-15)

Fig. 1.



Fig. 2.



Hauswirth u. A. Johann. (1-3)

Fig. 3.

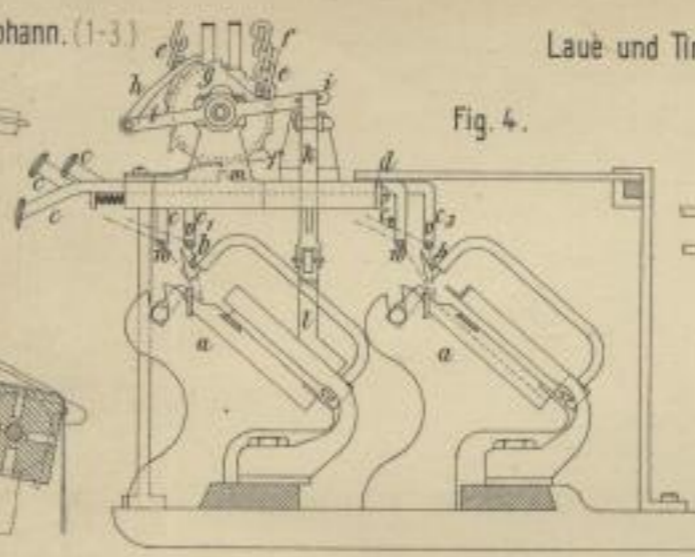
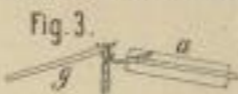


Fig. 4.

Laué und Timäus. (6 u. 7)

Fig. 5.

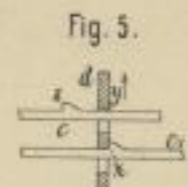
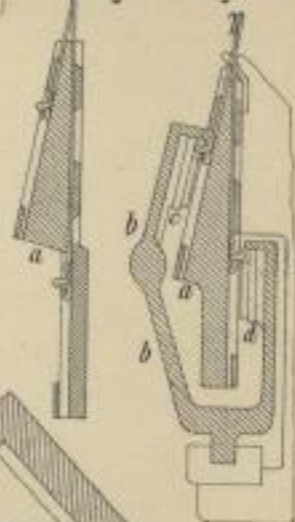
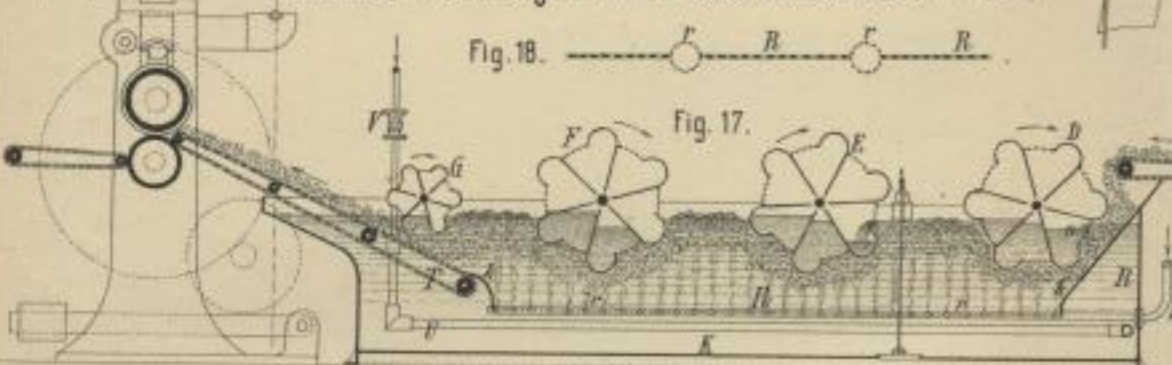


Fig. 6. Fig. 7.



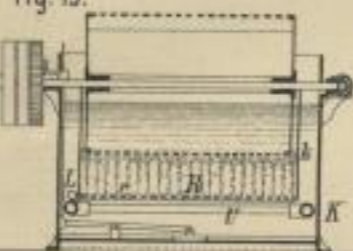
E. Mehl's Neuerungen an Wollwaschmaschinen. (17-20)

Fig. 18. — R — R —



H. Schürer. (4 u. 5)

Fig. 19.



G. F. Großser. (8 u. 9)

Fig. 9.

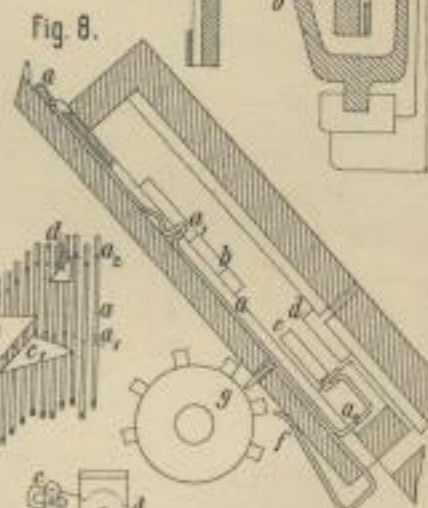
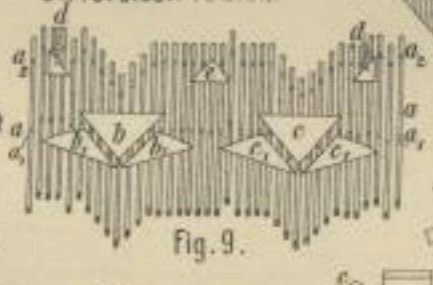
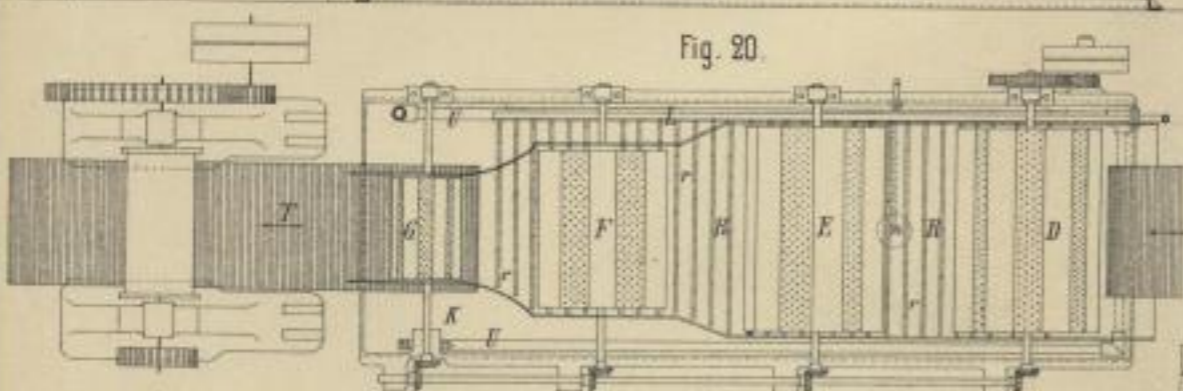


Fig. 20.



C. Terrot. (14 u. 15)

Fig. 14.

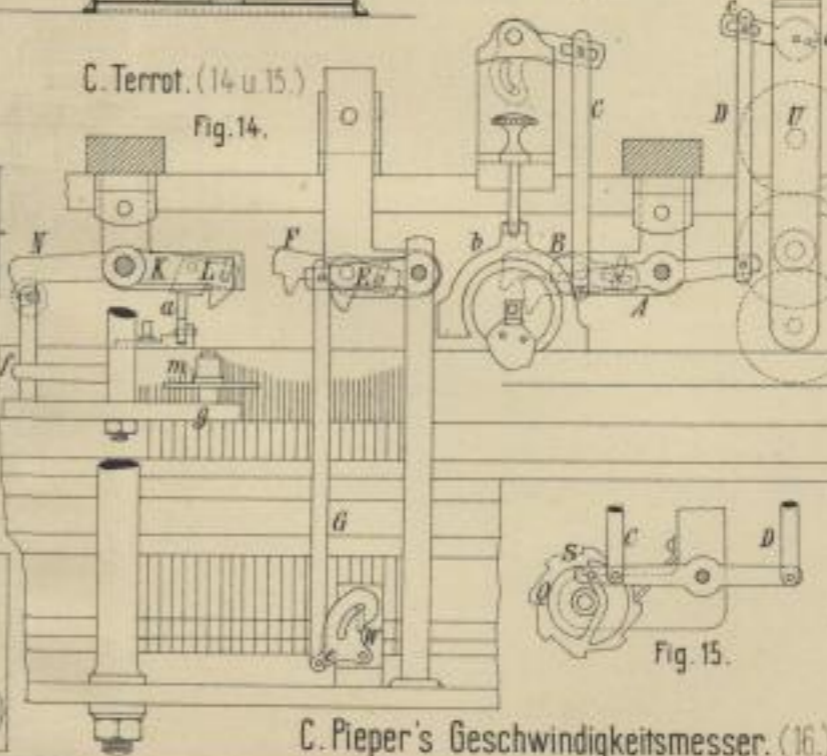


Fig. 15.

C. Pieper's Geschwindigkeitsmesser. (16.)

Fig. 16.

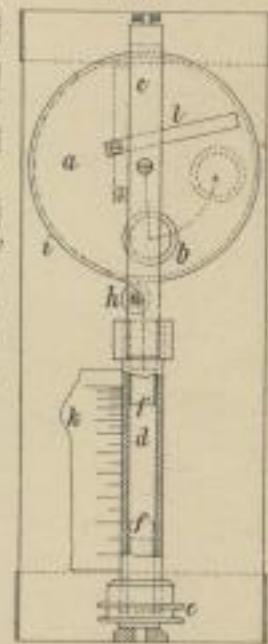


Fig. 10.

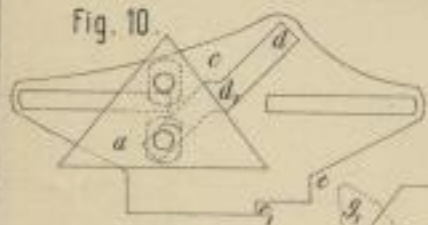


Fig. 11.

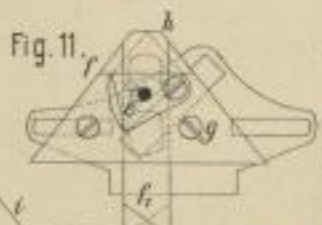


Fig. 13.

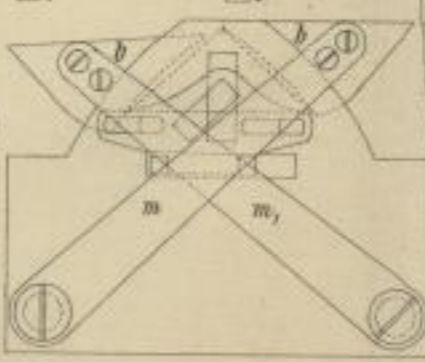


Fig. 12.

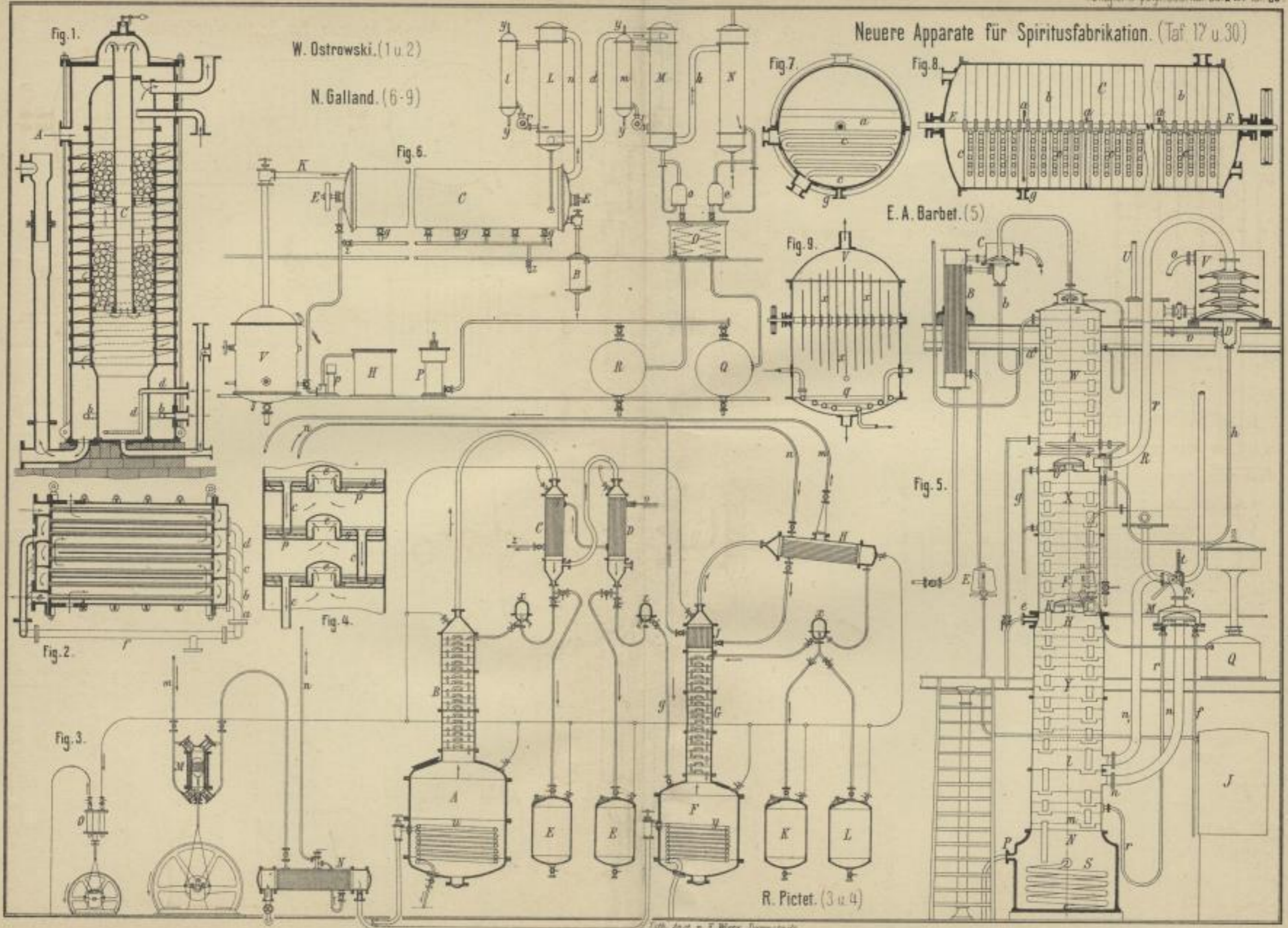


G. L. Oemler. (10-13)

Lith. Anst. v. F. Wirtz, Darmstadt



Neuere Apparate für Spiritusfabrikation. (Taf. 17 u. 30)



W. Ostrowski. (1 u. 2)
N. Galland. (6-9)

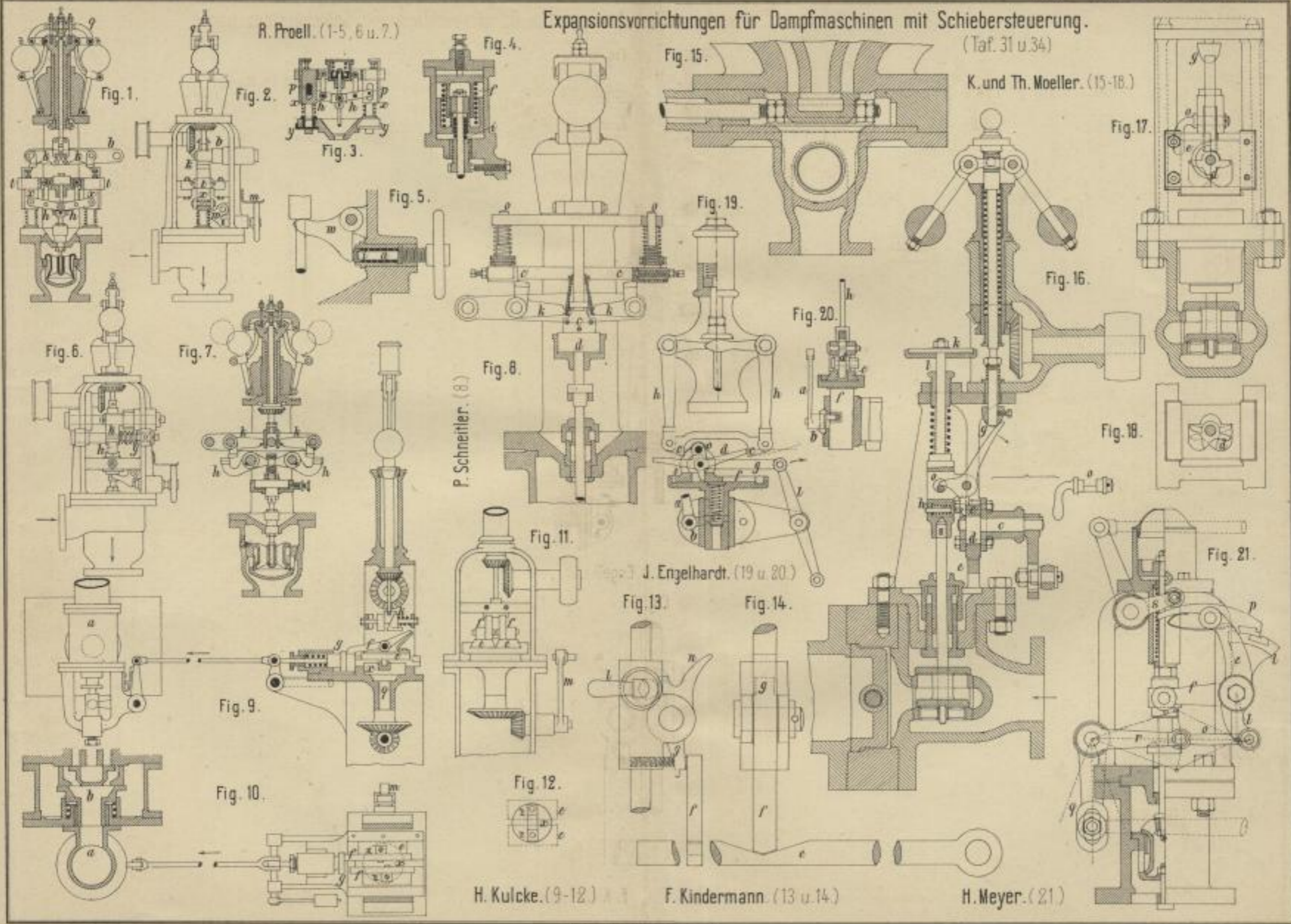
E. A. Barbet. (5)

R. Pictet. (3 u. 4)

Lith. Anst. v. F. Weyx, Darmstadt

Expansionsvorrichtungen für Dampfmaschinen mit Schiebersteuerung.

(Taf. 31 u. 34)



R. Proell. (1-5, 6 u. 7.)

K. und Th. Moeller. (15-18.)

P. Schnettler. (8.)

J. Engelhardt. (19 u. 20.)

H. Kulcke. (9-12.)

F. Kindermann. (13 u. 14.)

H. Meyer. (21.)

Lith. Anst. v. F. W. G. Neumann

Neuerungen in der Herstellung von Holzschliff. (1-11)

Krahnwagen. (12-16)

A. Deser. (1)

F. Dopp. (12 u 13)

Fig. 1.

Fig. 2.

Fig. 12.

Goetjes und Schulze. (2 u 3)

Fig. 3.

G. Werner und F. Voith. (8 u 9)

Fig. 8.

H. Ward. (14-16)

Fig. 14.

Fig. 13.

P. Büttner und E. Paschke. (4 u 5)

Fig. 4.

Fig. 5.

Fig. 9.

Fig. 11.

Fig. 15.

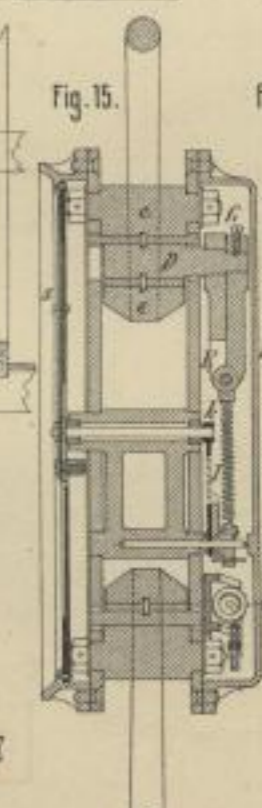
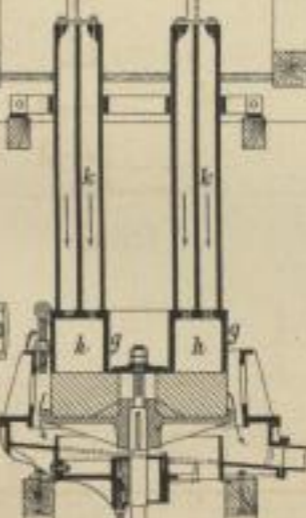
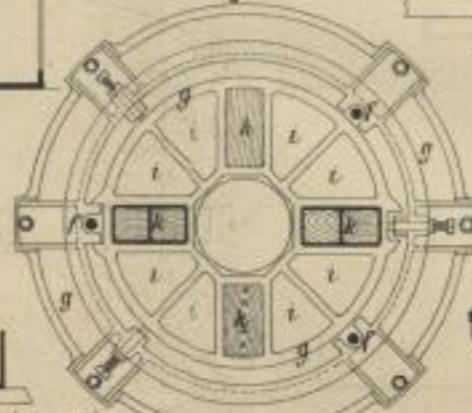
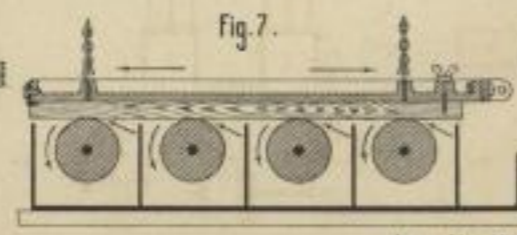
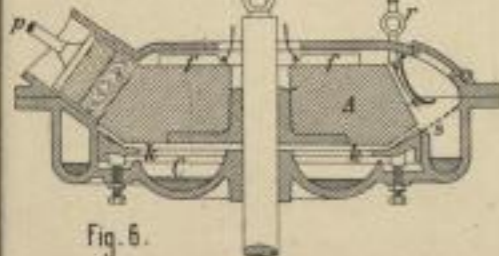
Fig. 16.

A. Polster. (6)

C. Freitag. (7)

Fig. 7.

Fig. 10.

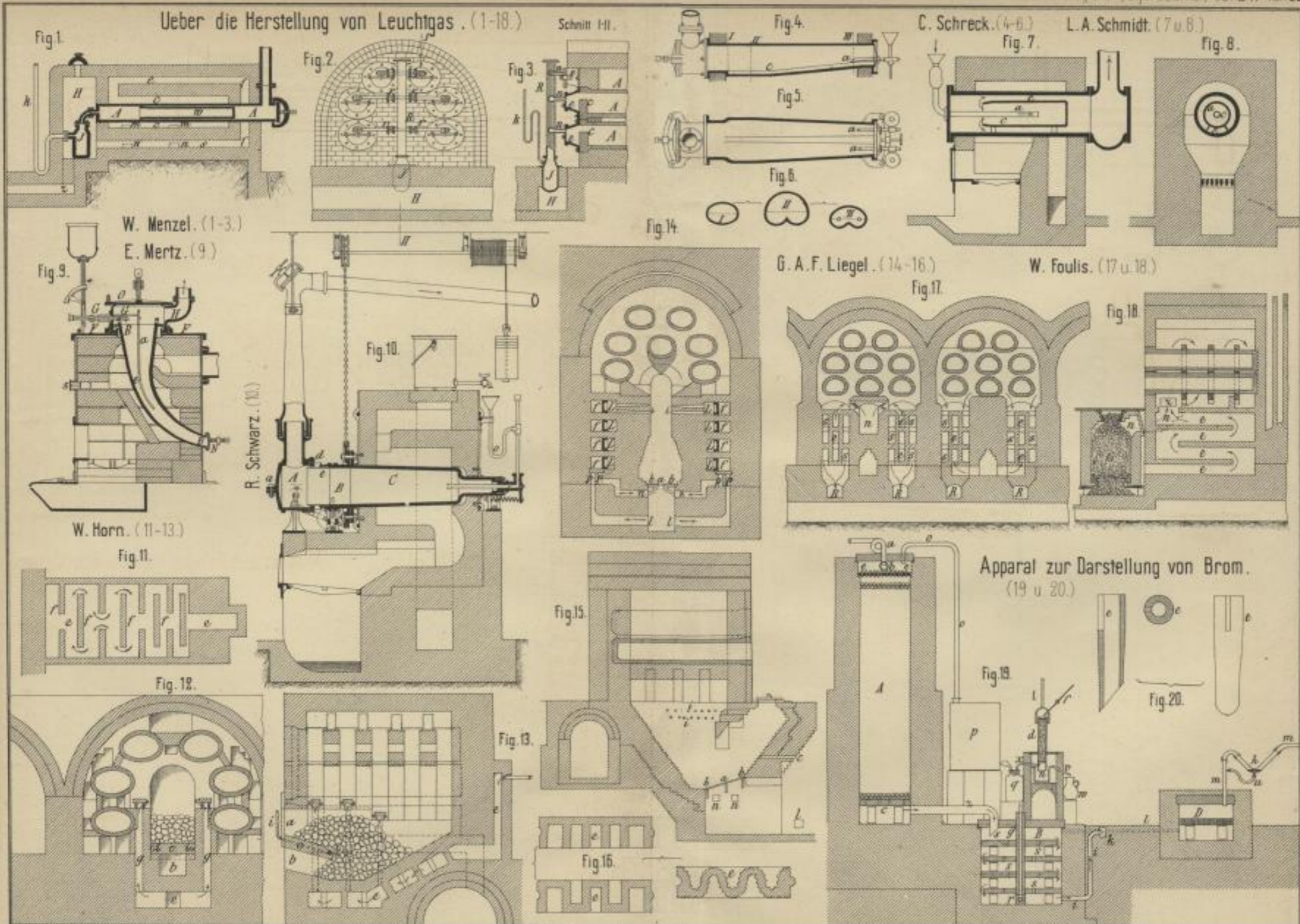


Aug. Abadie. (10 u 11)

Lith. Anst. v. F. Witz, Darmstadt

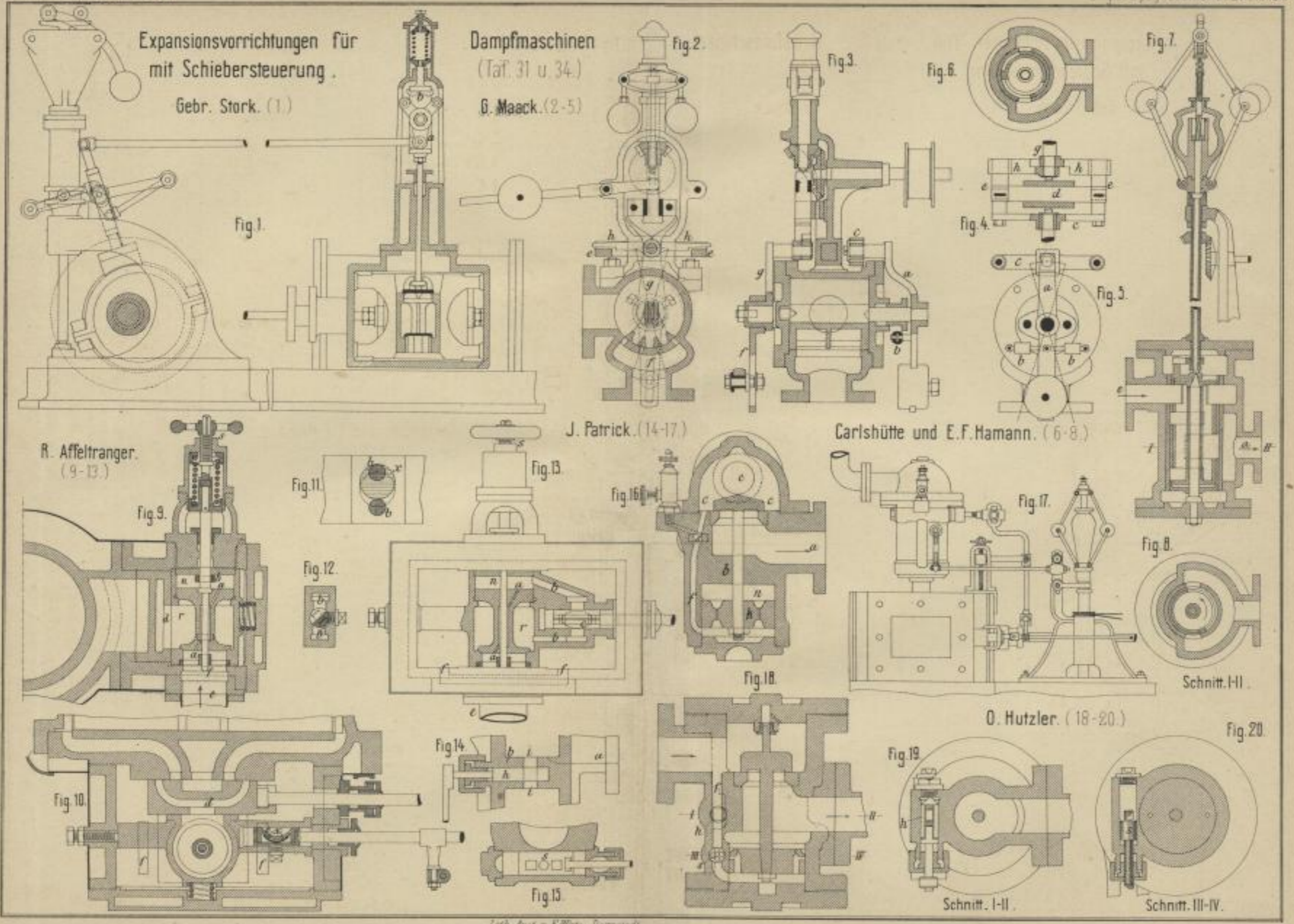
Ueber die Herstellung von Leuchtgas. (1-18.)

Schnitt III.



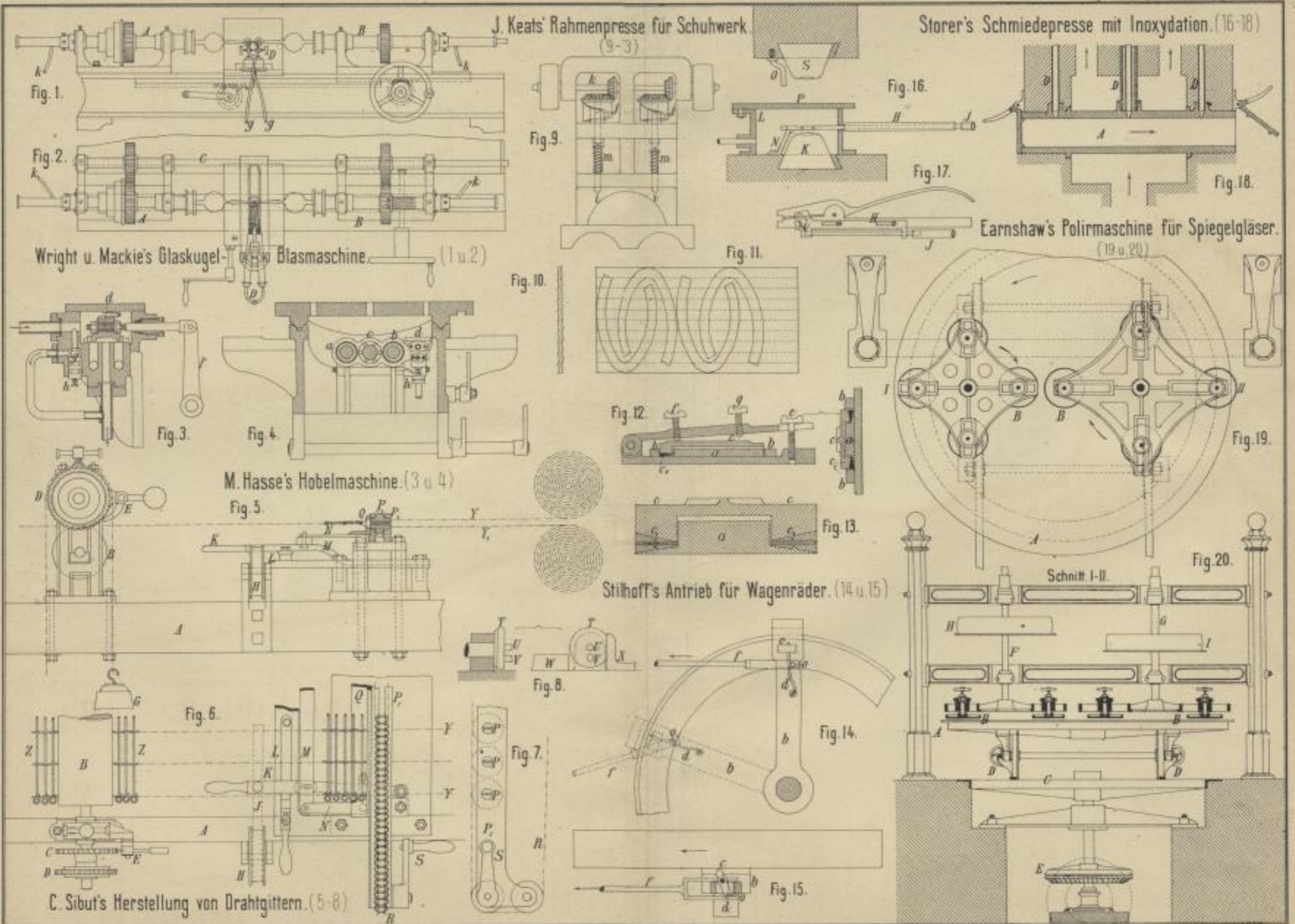
Lith. Anst. v. F. Wirtz Darmstadt





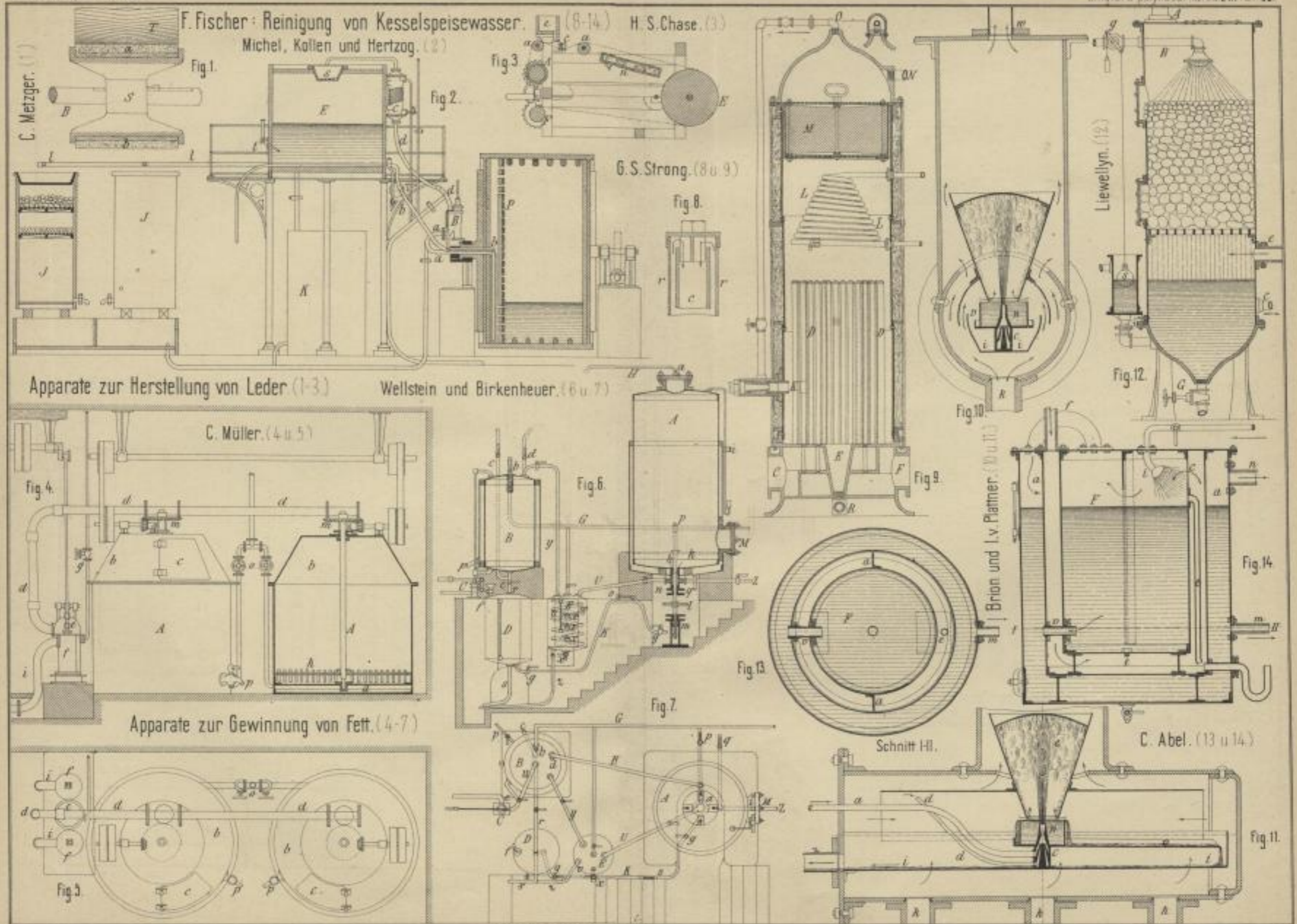
Lith. Anst. v. F. Wirtz, Darmstadt.



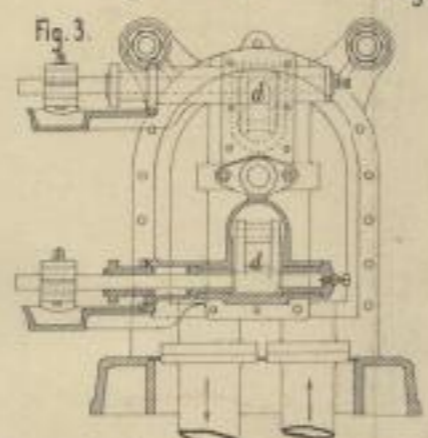
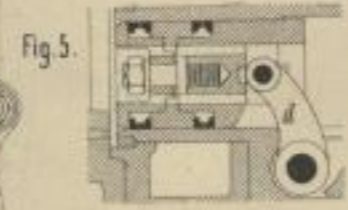
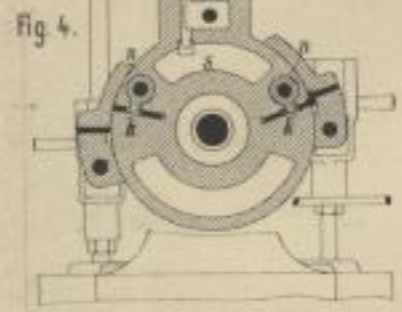
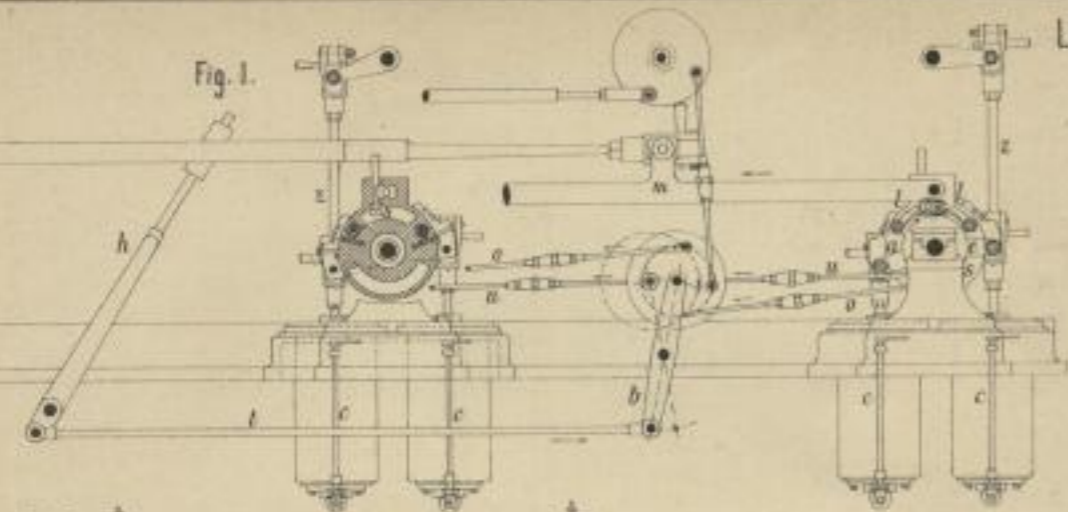


Lith. Anst. v. F. Wirtz Darmstadt

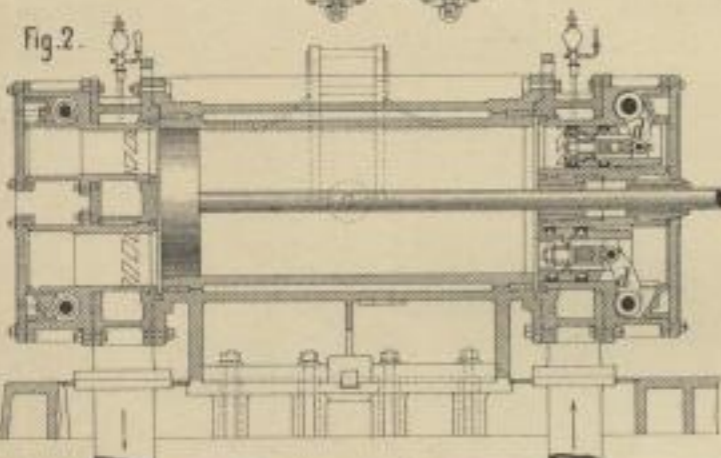
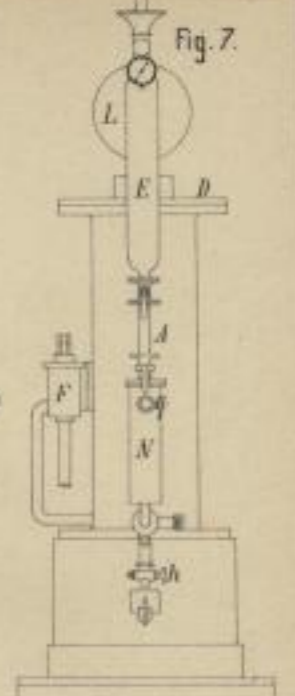
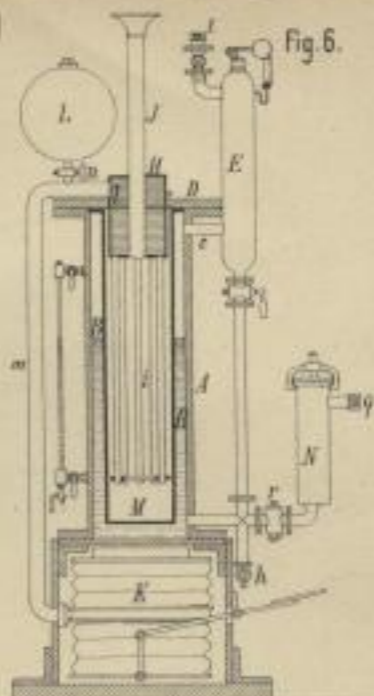




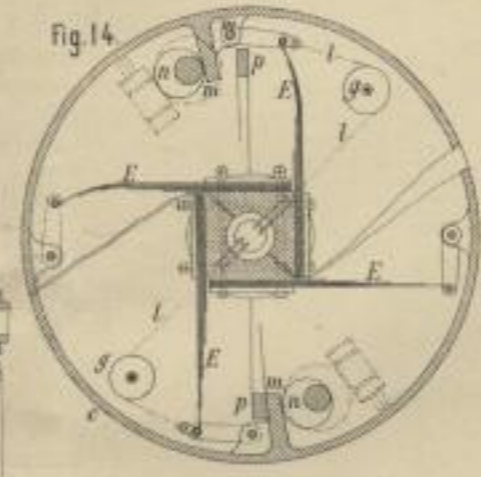
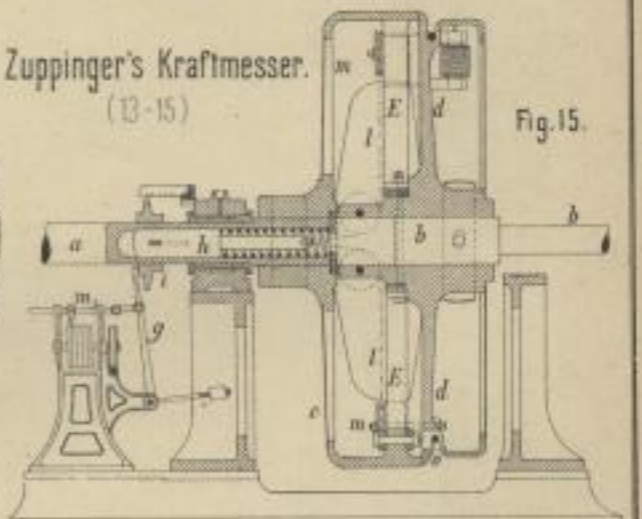
Lambert's auslösende Kolbensteuerung. (1-5)



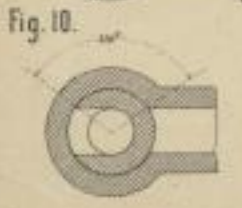
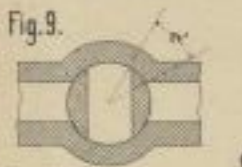
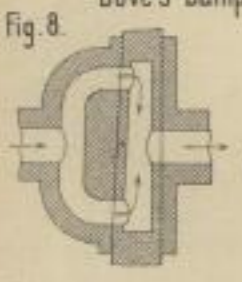
Spiel's Kleindampfkessel. (6 u 7)



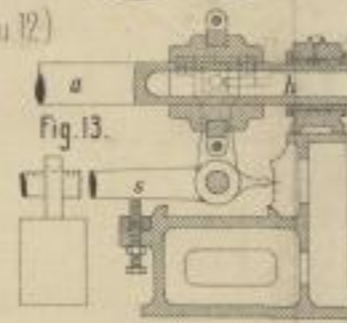
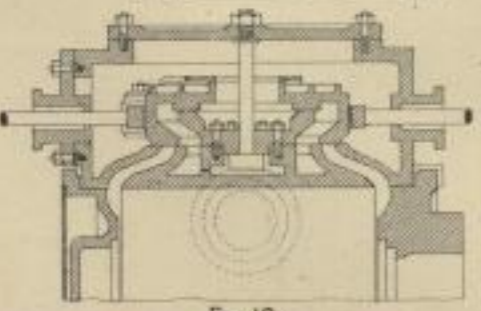
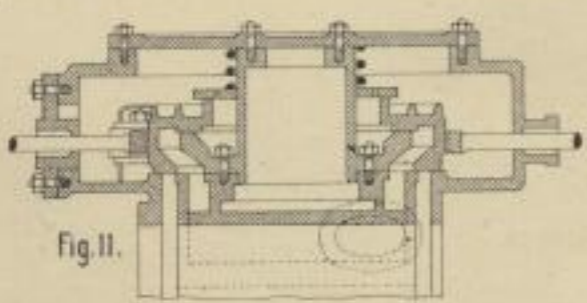
Zuppinger's Kraftmesser. (13-15)



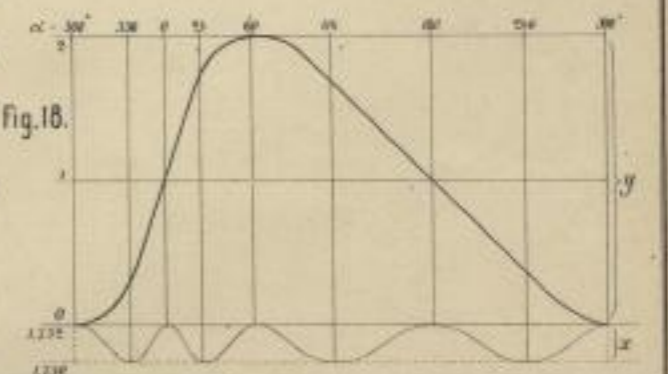
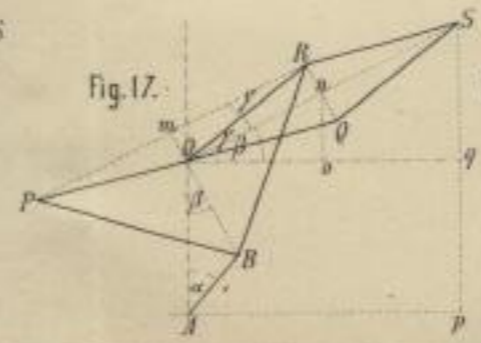
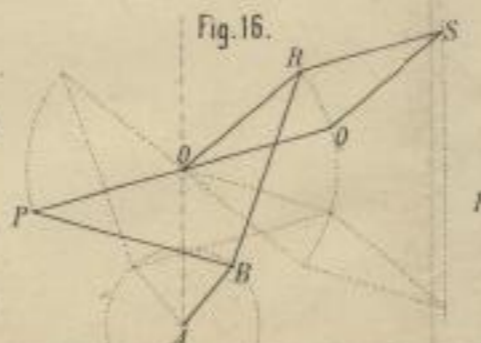
Dove's Dampfahh. (8-10)



Church's entlasteter Schieber. (11 u 12)

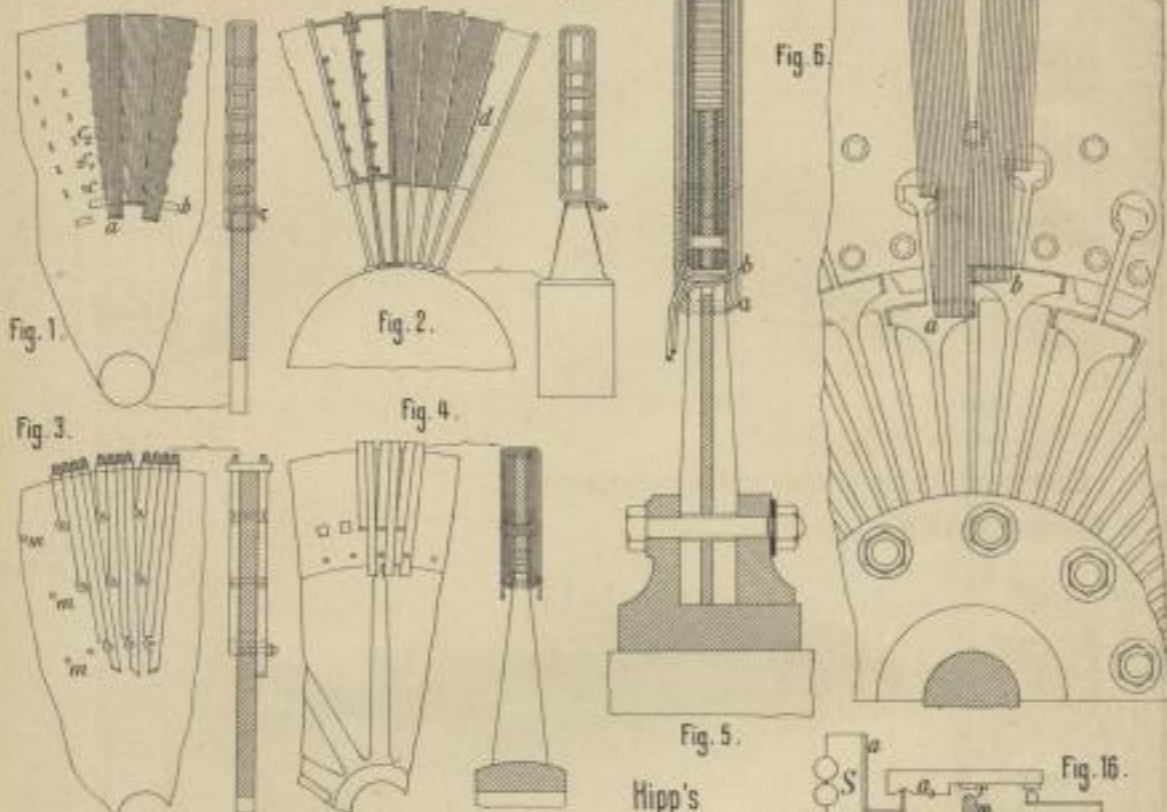


Jarolimek's Geradföhrung. (16-18)



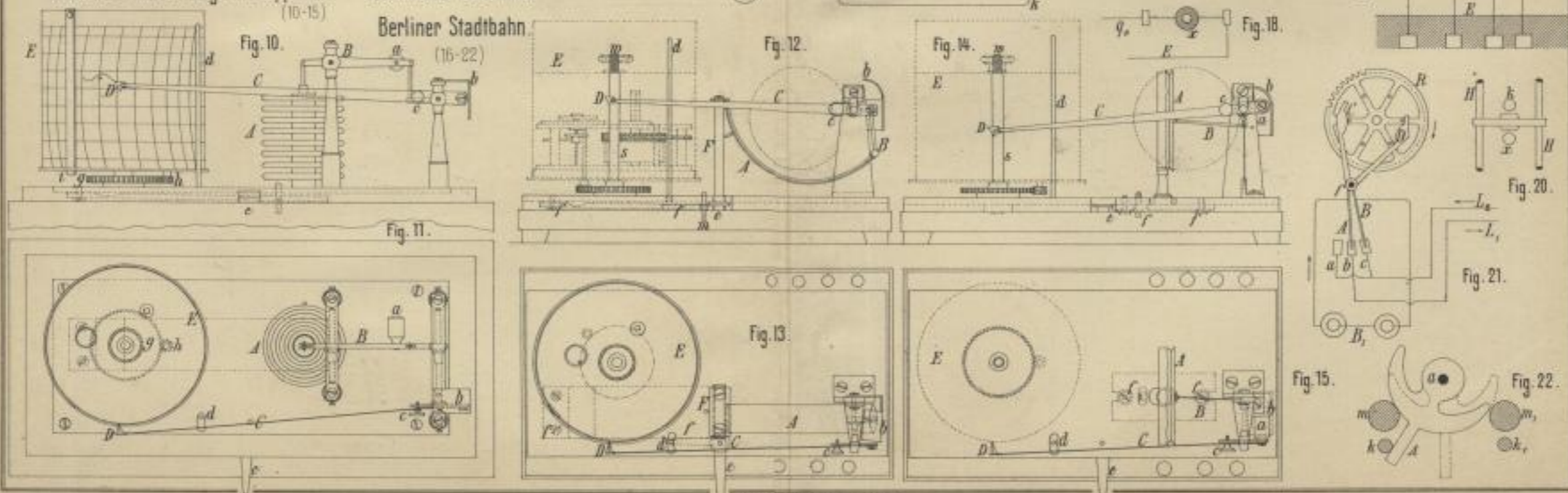
Lith. Anst. v. Witz Darmstadt.

Crompton's Staffelförmige Bewickelung. (1-6)

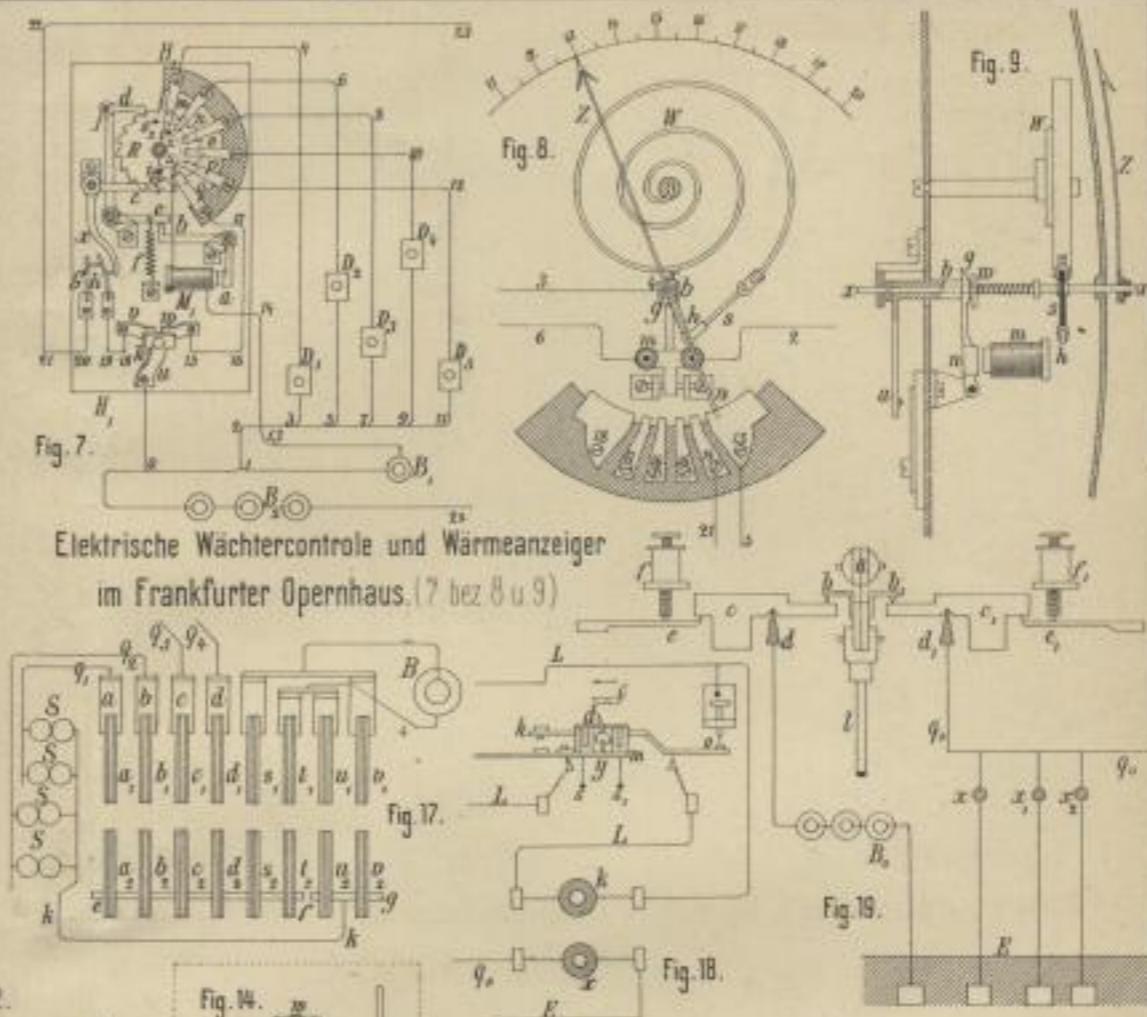


Richard's meteorologische Apparate. (10-15)

Hipp's Elektrische Uhren der Berliner Stadtbahn. (16-22)



Elektrische Wächtercontrole und Wärmeanzeiger im Frankfurter Opernhaus. (7 bez 8 u 9)



Lith. Anst. v. E. Wirtz, Darmstadt.



X

Technol. A. 264.

SLUB DRESDEN



3 2422831