

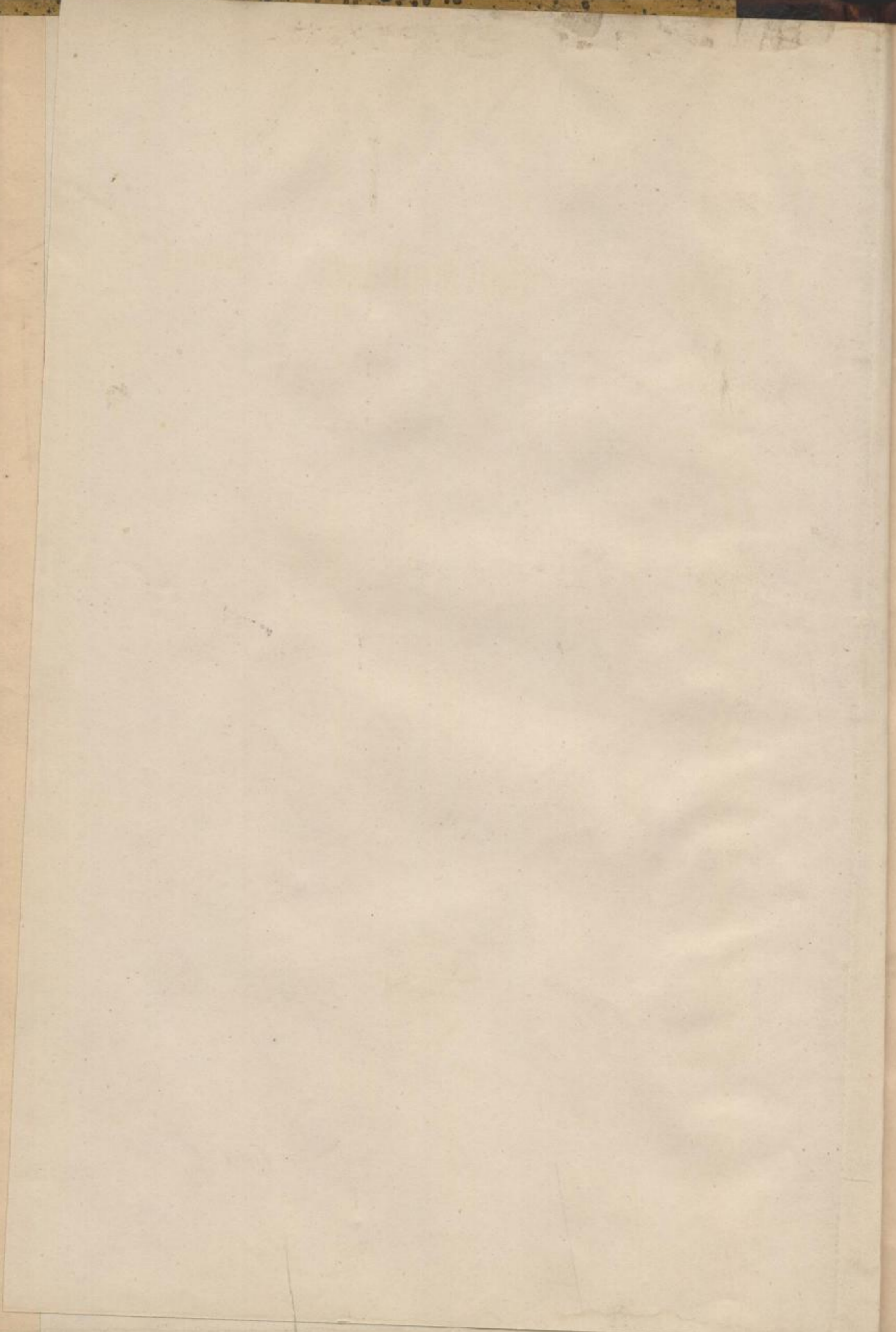

Handwritten text, likely a title or chapter heading, appearing as a faint watermark or bleed-through from the reverse side of the page.

Handwritten text, possibly a page number or a specific section identifier, appearing as a faint watermark or bleed-through from the reverse side of the page.



Atlas

zu

Dingler's polytechnischem Journal.

Band 246.

(Dreiundsechzigster Jahrgang.)

Jahrgang 1882.

Enthaltend 40 lithographirte Tafeln.



Stuttgart.

Verlag der J. G. COTTA'schen Buchhandlung.

00831

Atlas

Journal des voyageurs en Sibirie

Band 246

(Beschreibung der Provinz Irkutsk)

Stuttgart 1822

Verlag des Buchhändlers J. Neumann, Neudamm

Sächsische Landesbibliothek
Dresden



Sächs.
Landes-
Bibl

Neuerungen an Gliederkesseln. (Taf. 1 u 4)

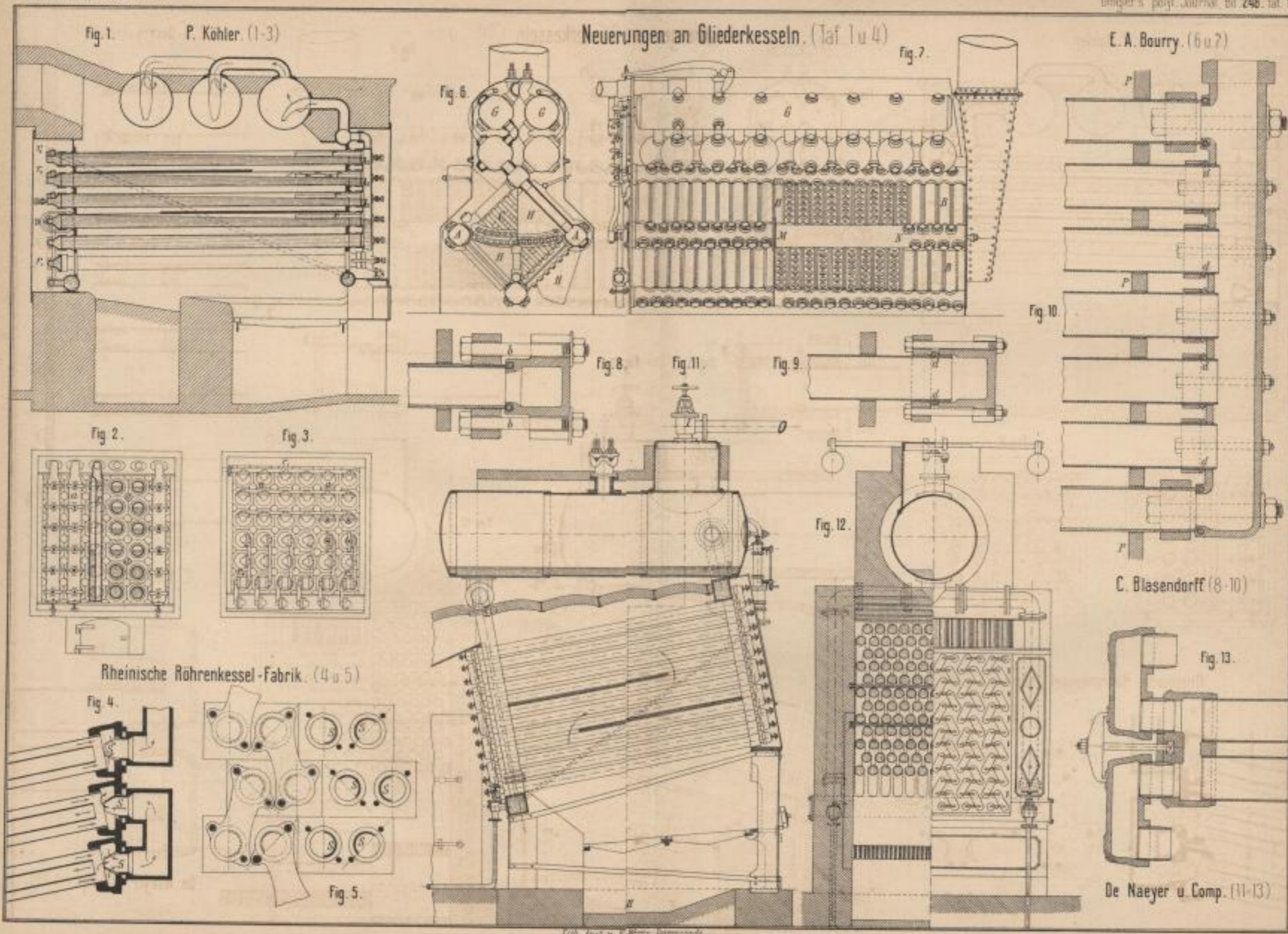

Fig. 1. P. Köhler. (1-3)

Fig. 6.

Fig. 7.

E. A. Bourry. (6 u 7)

Fig. 2.

Fig. 3.

Fig. 8.

Fig. 11.

Fig. 9.

Fig. 10.

Rheinische Röhrenkessel-Fabrik. (4 u 5)

Fig. 4.

Fig. 5.

Fig. 12.

Fig. 13.

C. Blasendorff (8-10)

De Naeyer u. Comp. (11-13)

Loth. Anst. u. P. Wirtz, Darmstadt.

Herm. Fischer: Ueber Herstellung der Sandgussformen mittels sogen. Formmaschinen. (1-14)

Level's hydraulischer Abtreibekeil. (15-18)

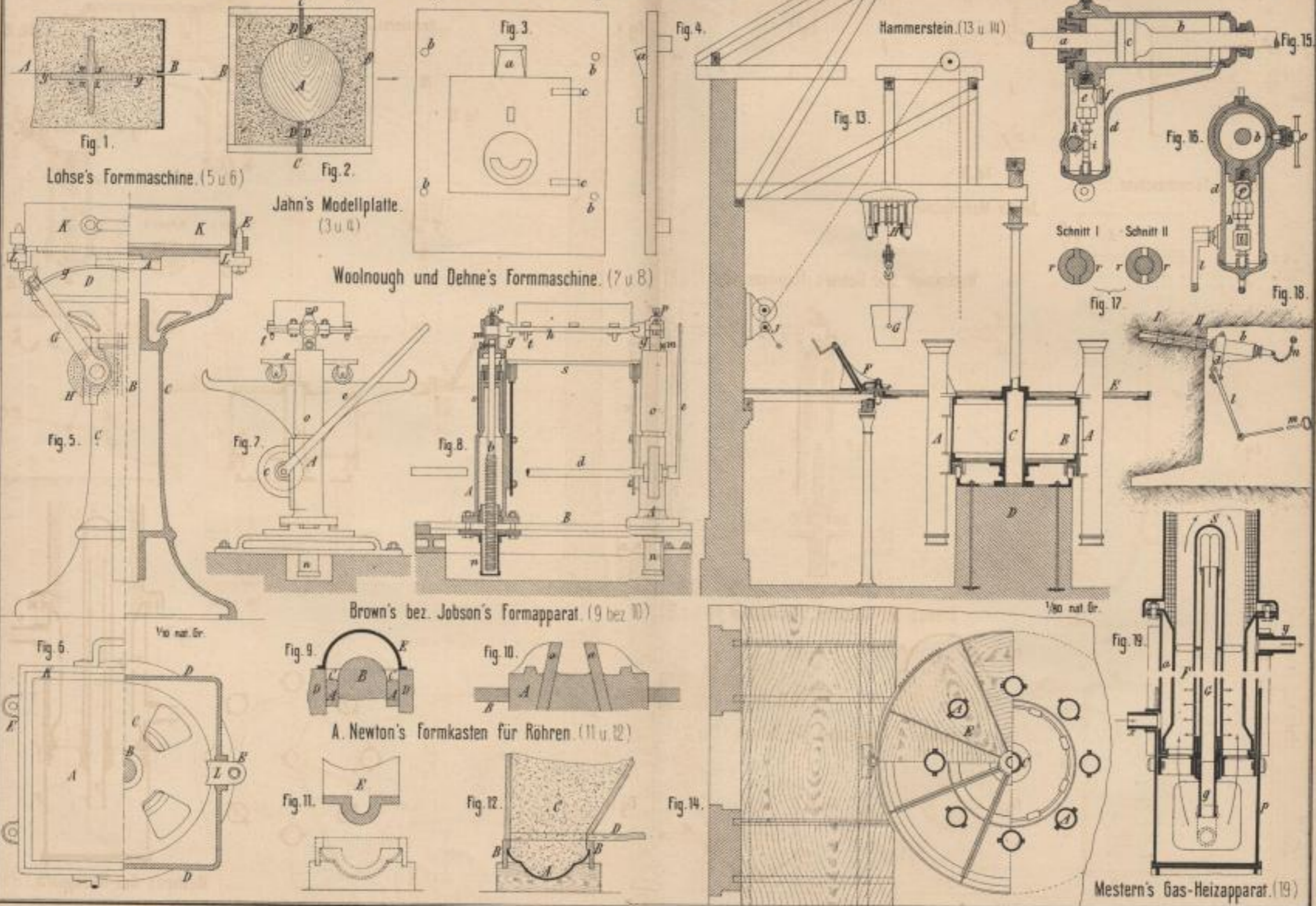

Lohse's Formmaschine. (5 u 6)

Jahn's Modellplatte. (3 u 4)

Woolnough und Dehne's Formmaschine. (7 u 8)

Brown's bez. Jobson's Formapparat. (9 bez 10)

A. Newton's formkasten für Röhren. (11 u 12)

Hammerstein. (13 u 14)

Schnitt I Schnitt II

1/80 nat Gr.

Mestern's Gas-Heizapparat. (19)

Lith. Anst. v. F. Witz, Darmstadt.

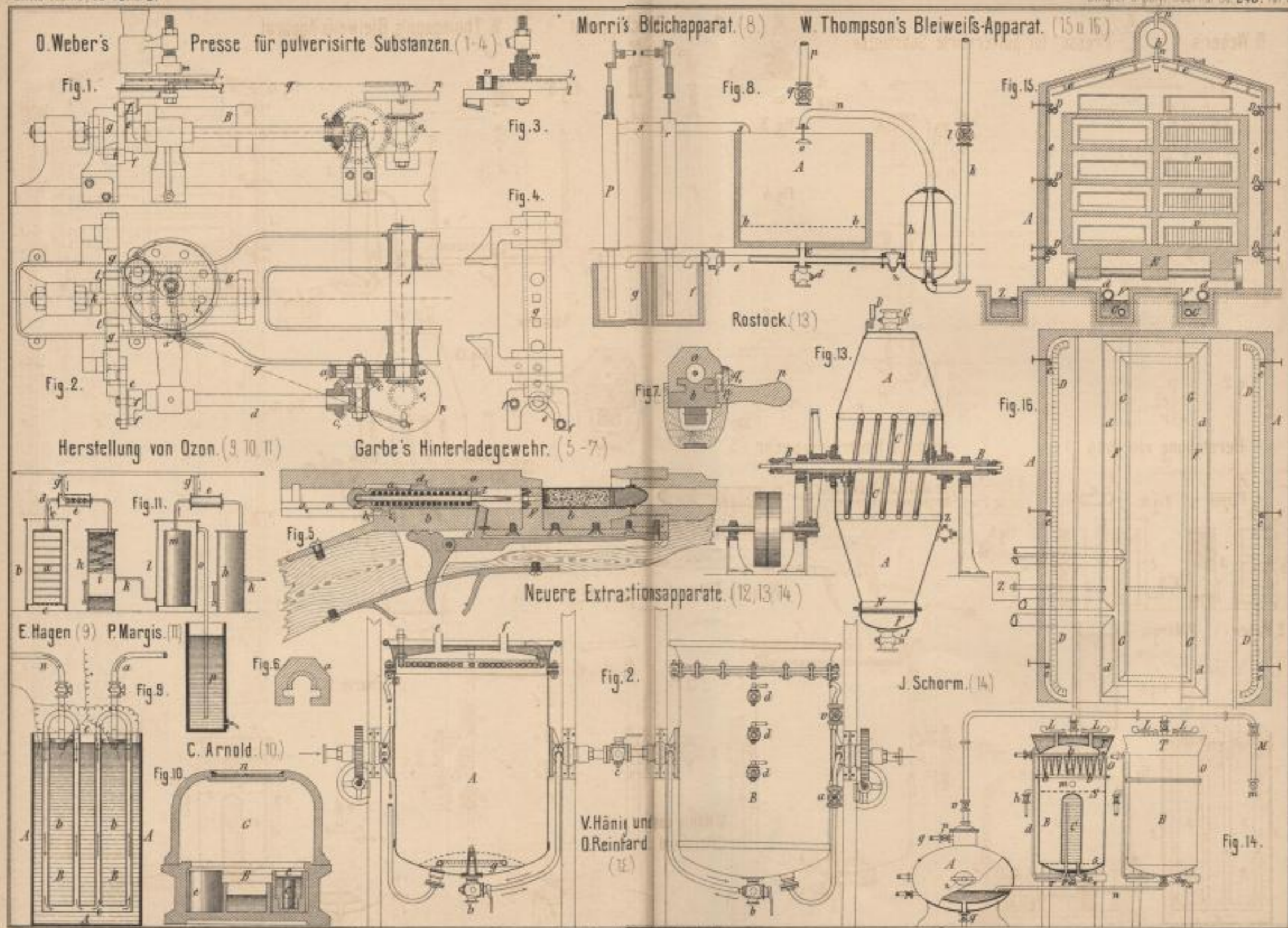

Lith. Anstalt v. F. W. Schmidt, Darmstadt.

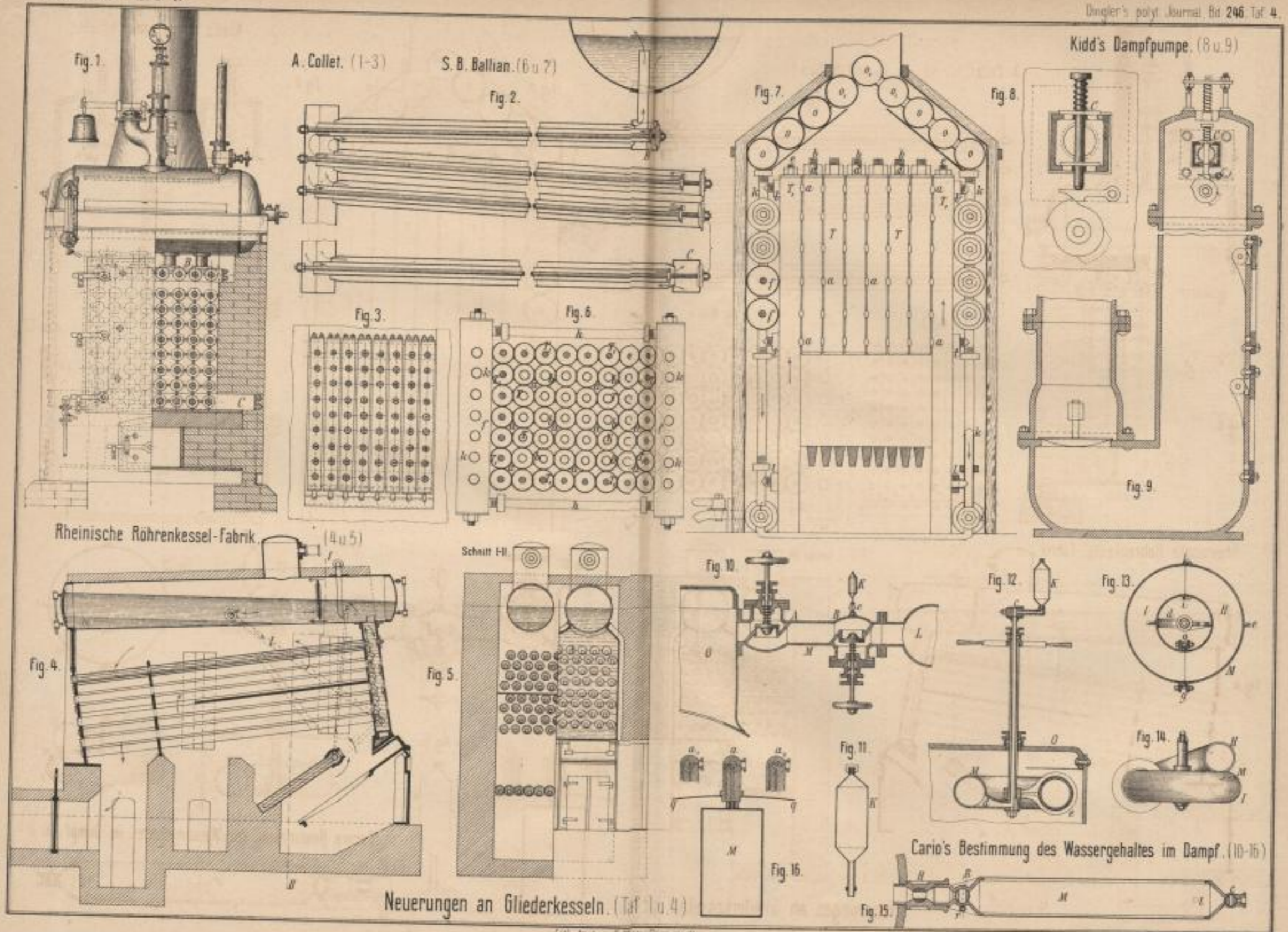

Lith. Anst. v. F. W. G. D. W. G.

C. Jamnig. (1 u. 2)

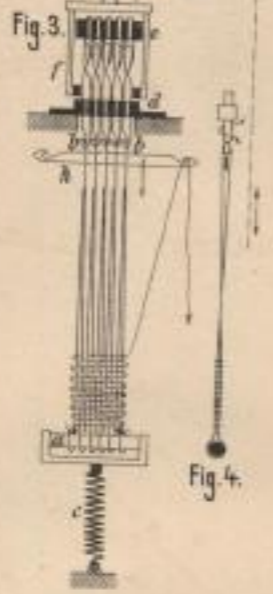
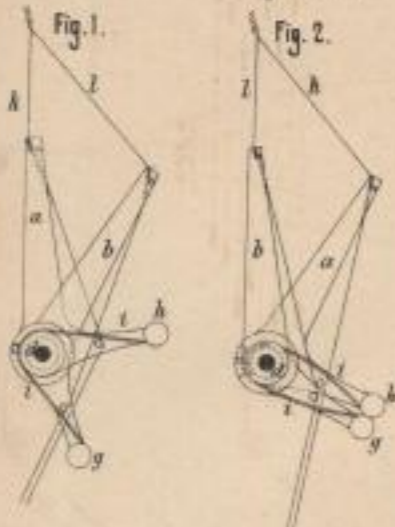

W. O. Lies. (5)



Vorwerk. (6, 7 u. 9)

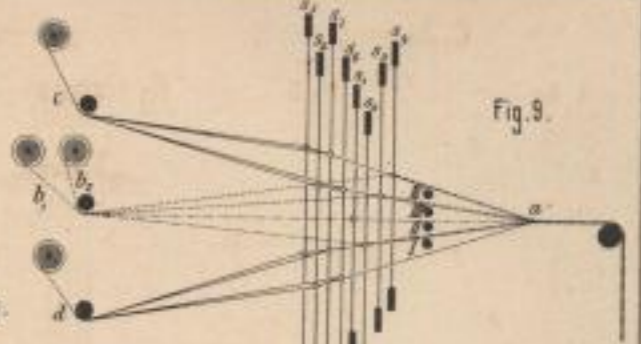
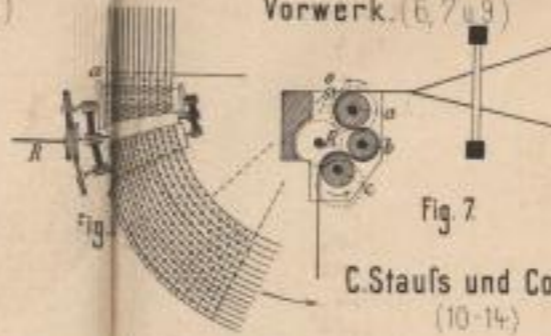

C. Staufs und Comp. (10-14)

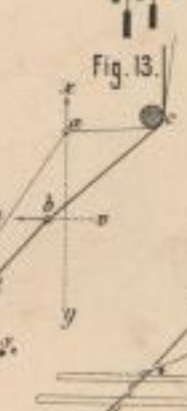

Aug. Philipp. (3 u. 4)

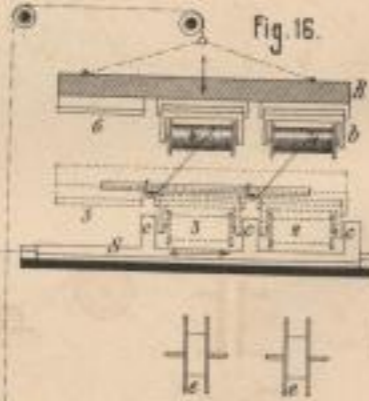
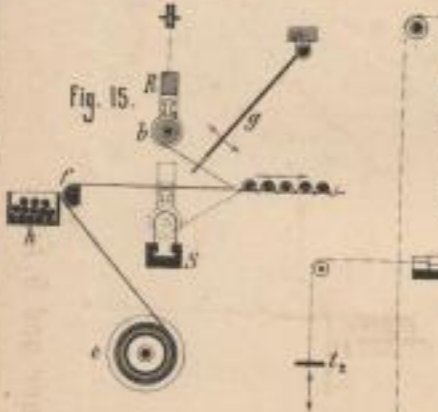

Neuerungen in der Gewebefabrikation. (Taf. 5)

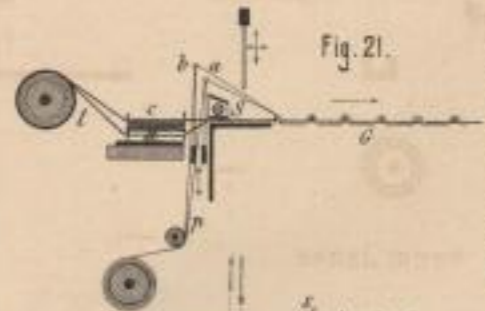
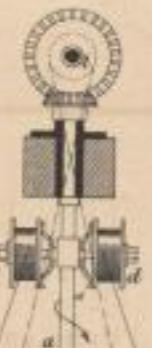
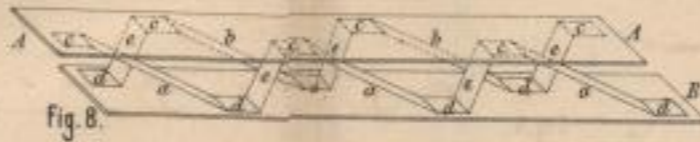

Knorr und G. Arndt. (21-24)

Herm. Janke. (15 u. 16)

J. Mahn und C. Kuhlmann. (19)

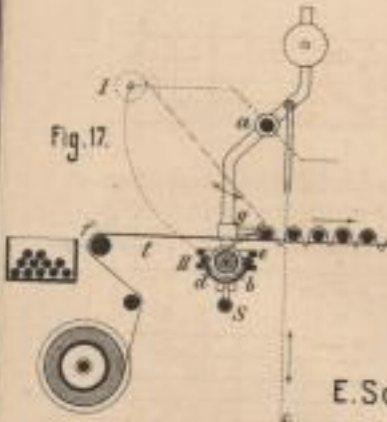

G. Boden. (8)

Scherrbacher und Buchheim. (20)

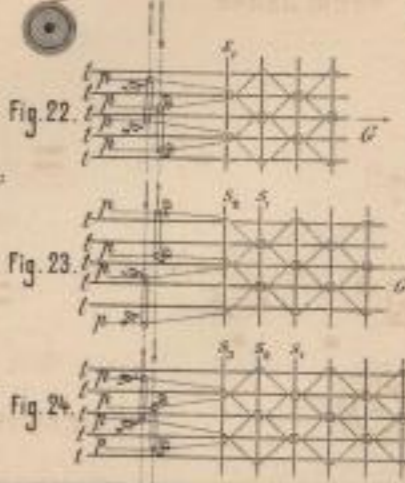
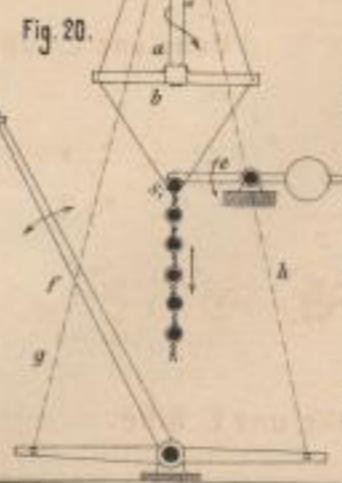
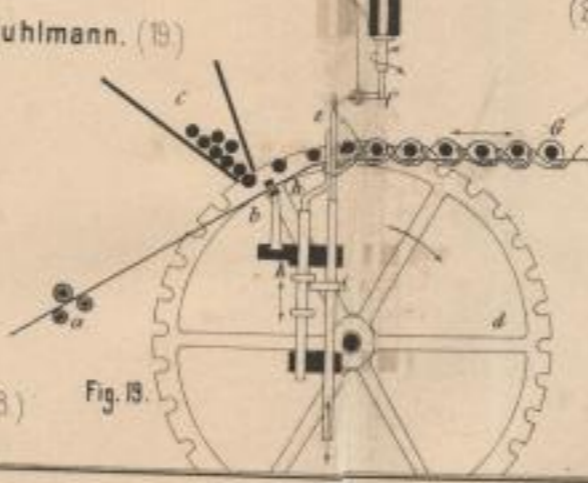

E. Schentke und E. Hille. (17 u. 18)

Taf. 5, Blatt 1 u. 2, 3, 4, 5, 6, 7, 8, 9, 10, 11, 12, 13, 14, 15, 16, 17, 18, 19, 20, 21, 22, 23, 24.

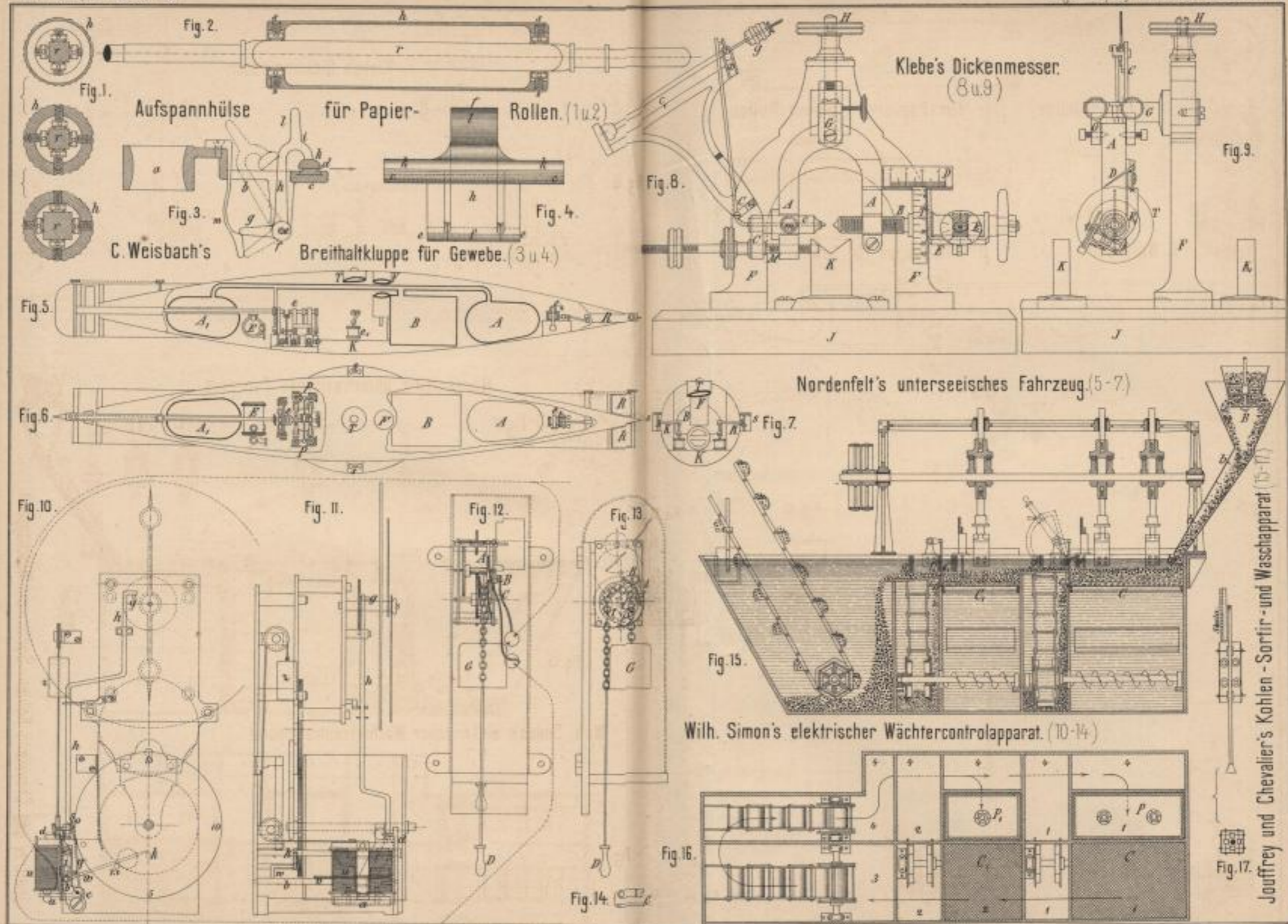

Lith. Anstalt v. F. W. W. Darmstadt.

Neuerungen an Steuerapparaten. (1-11.)

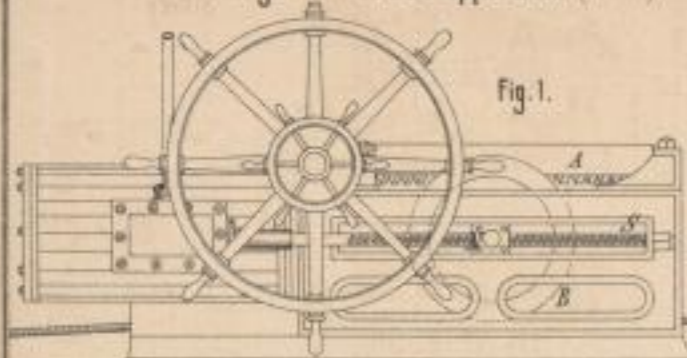

Fig. 1.

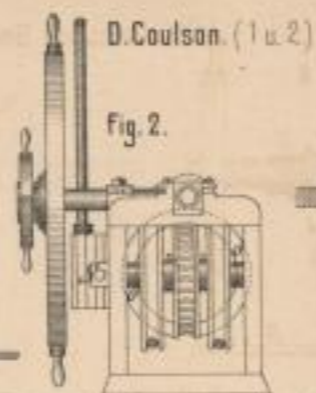

Fig. 2.

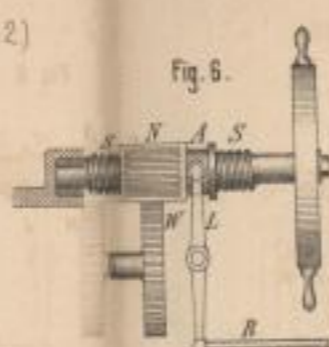

Fig. 6.

Amos und Smith. (6 u. 7)

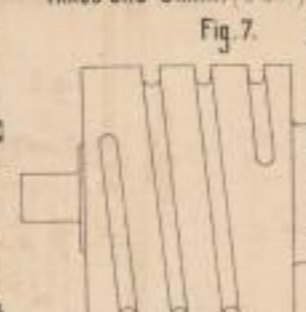
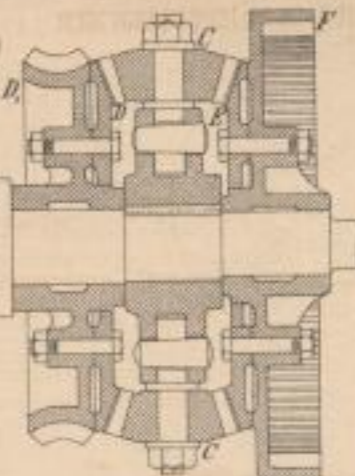

Fig. 7.



Simey (8)



Fig. 8.

E. E. Wigzell. (9-11)

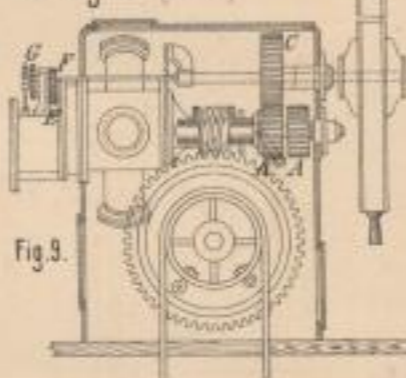

Fig. 9.

Bergmann und Hüttenmeier's Reibrädergetriebe. (15 u. 16)

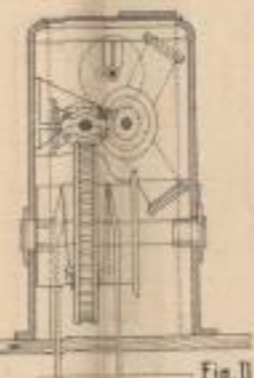
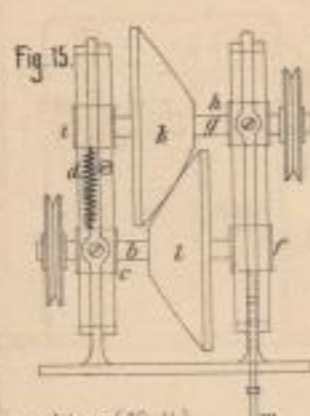

Fig. 11.



Kernaul's Dampfschieber. (17 u. 18)

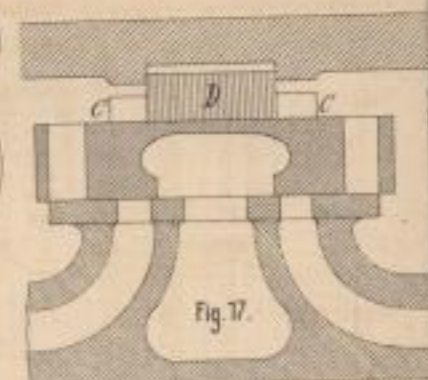

Fig. 17.

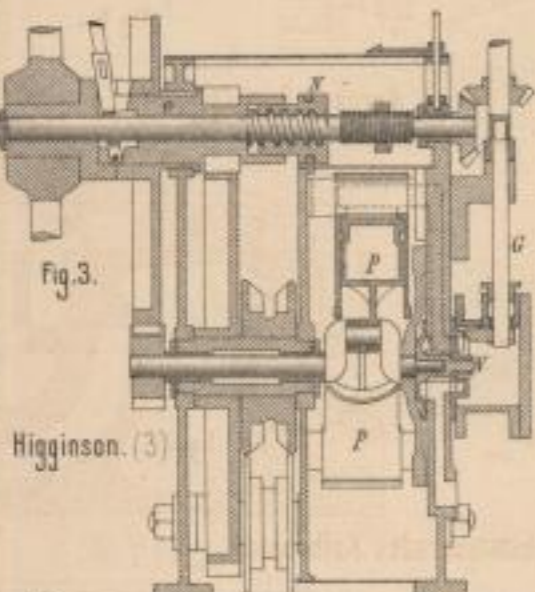

Fig. 3.

Higginson. (3)

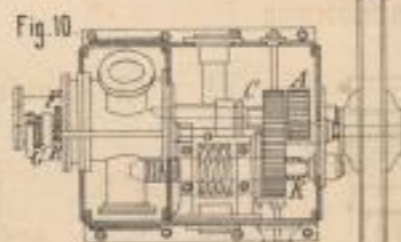

Fig. 10.

Musmann's Kleindampfmaschine. (12-14)

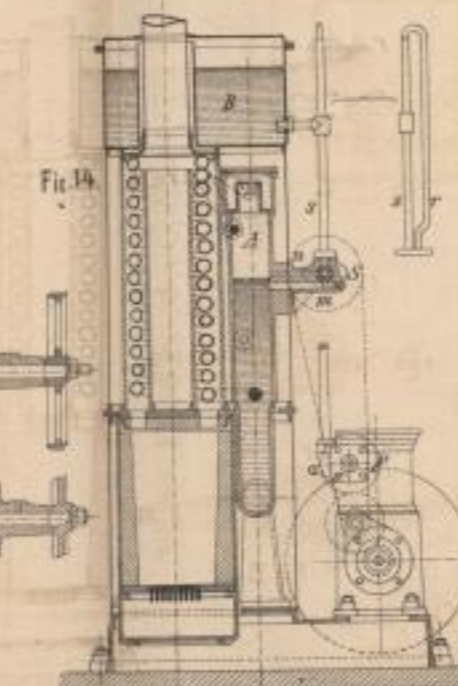

Fig. 14.

A. Schmid's selbststeuerndes Kolbenpaar. (19-22.)

Fig. 20.

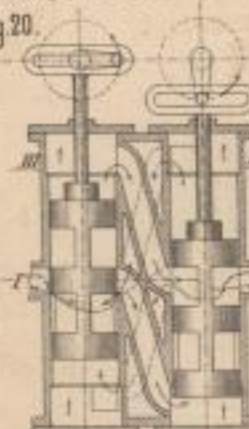

Fig. 19.

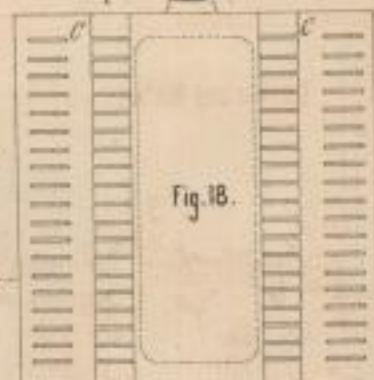

Fig. 18.

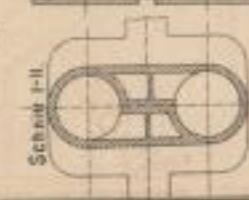

Fig. 21.

Schnitt II-III

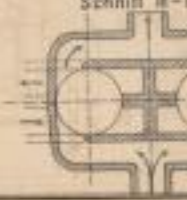
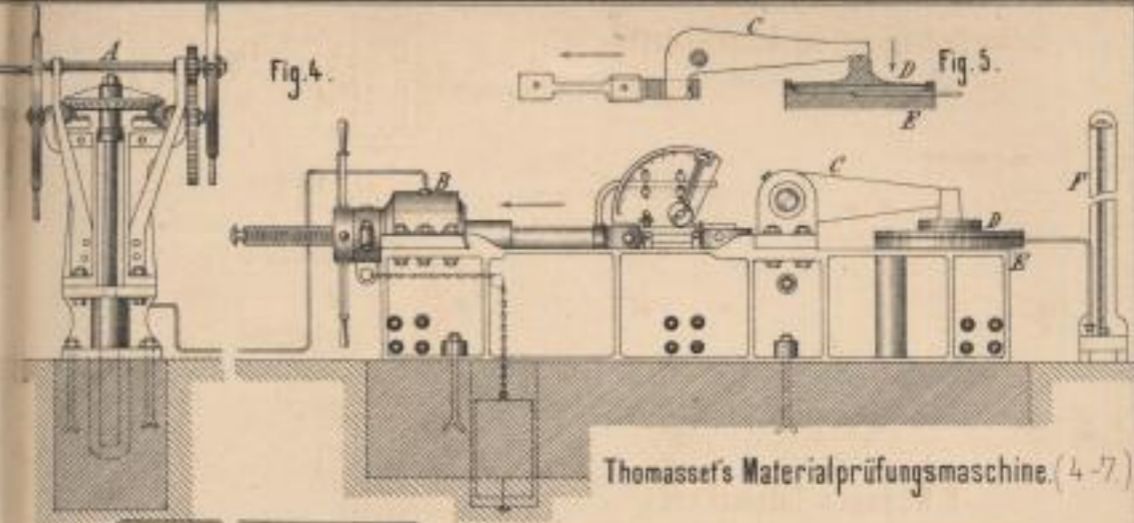
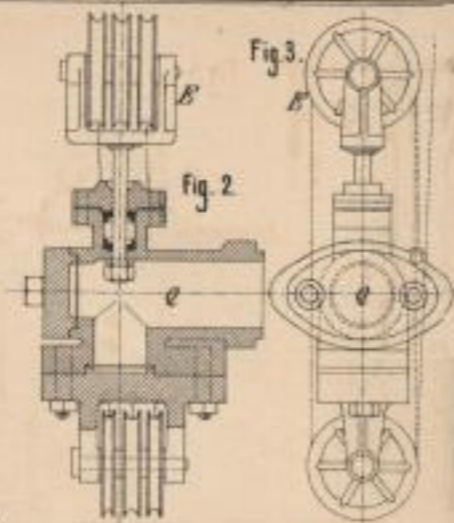
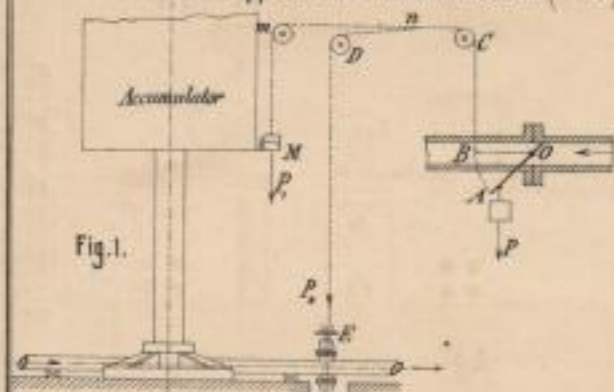

Fig. 22.

Lith. ausgef. v. F. W. B. in Darmstadt.

Sicherheitsapparat für Accumulatoren. (1-3.)



Thomasset's Materialprüfungsmaschine. (4-7.)

R. Wagner's Tafelschere. (8 u. 9.)

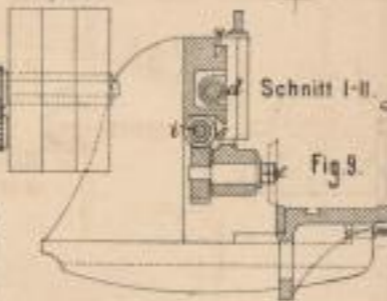
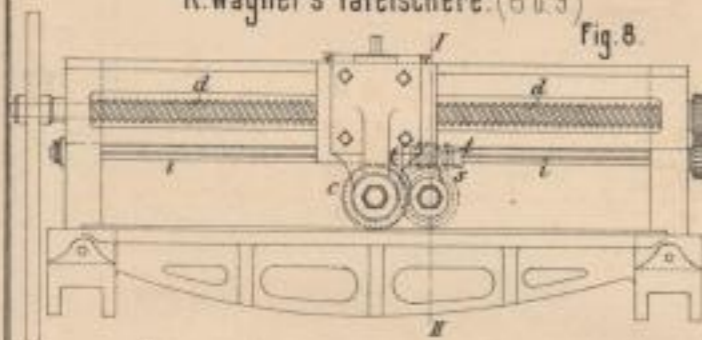

J. Thomson's Schraubstock (13 u. 14.)

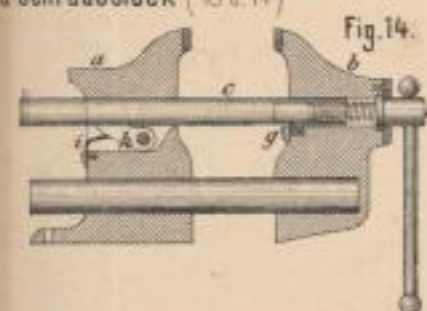

Laute's Seilfangvorrichtung (10-12.)

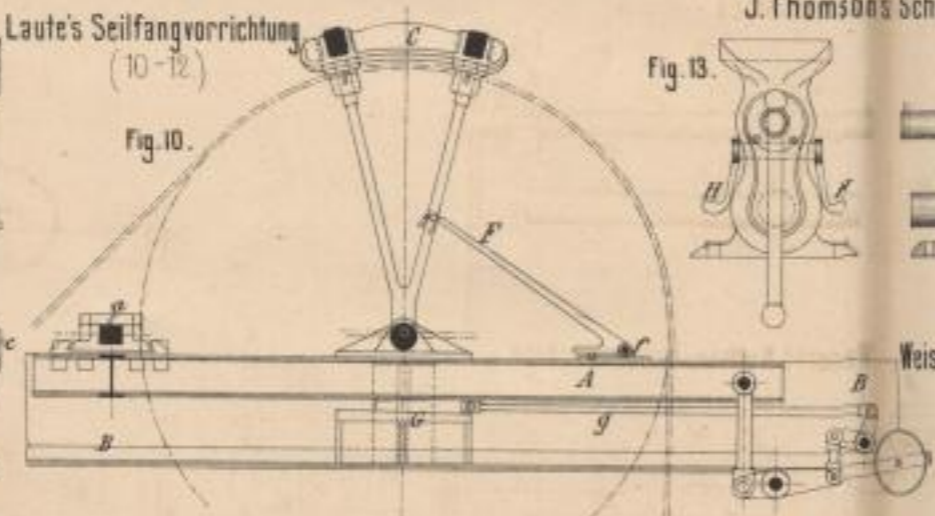
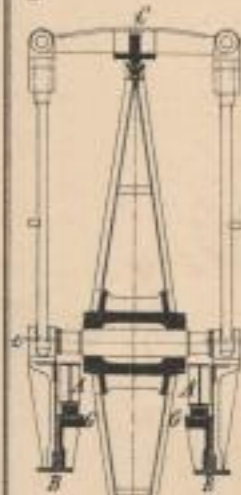

Weisert's Nuthen-Fräsmaschine. (15 u. 16.)

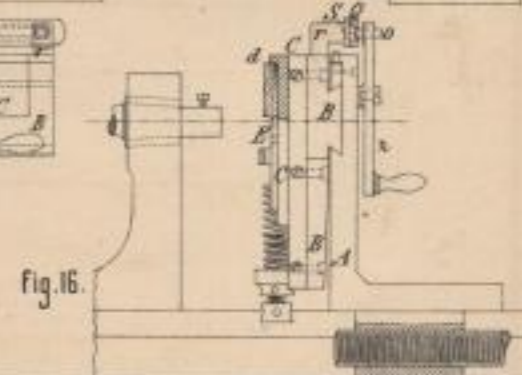
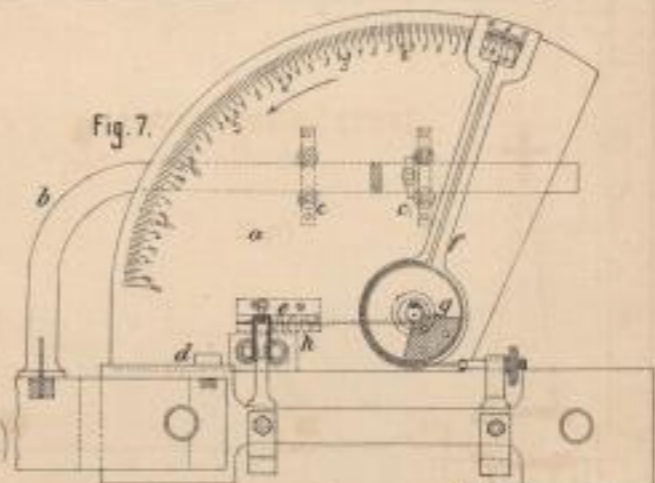
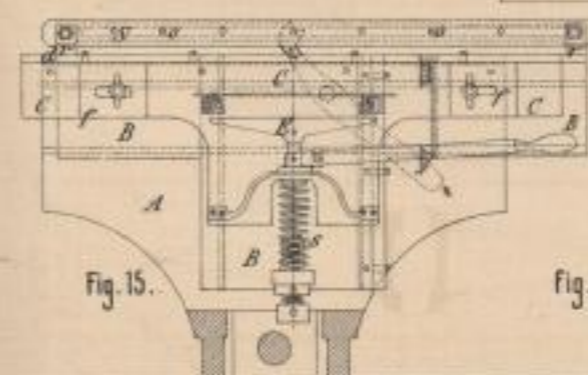

Lith. Anstalt v. F. W. v. Dornstadt

R. M. Daelen's Gießpfannenwagen zum Absetzen und mit Kippvorrichtung

Schlink's Gichtverschlufs für Hochofen. (9 u. 10)

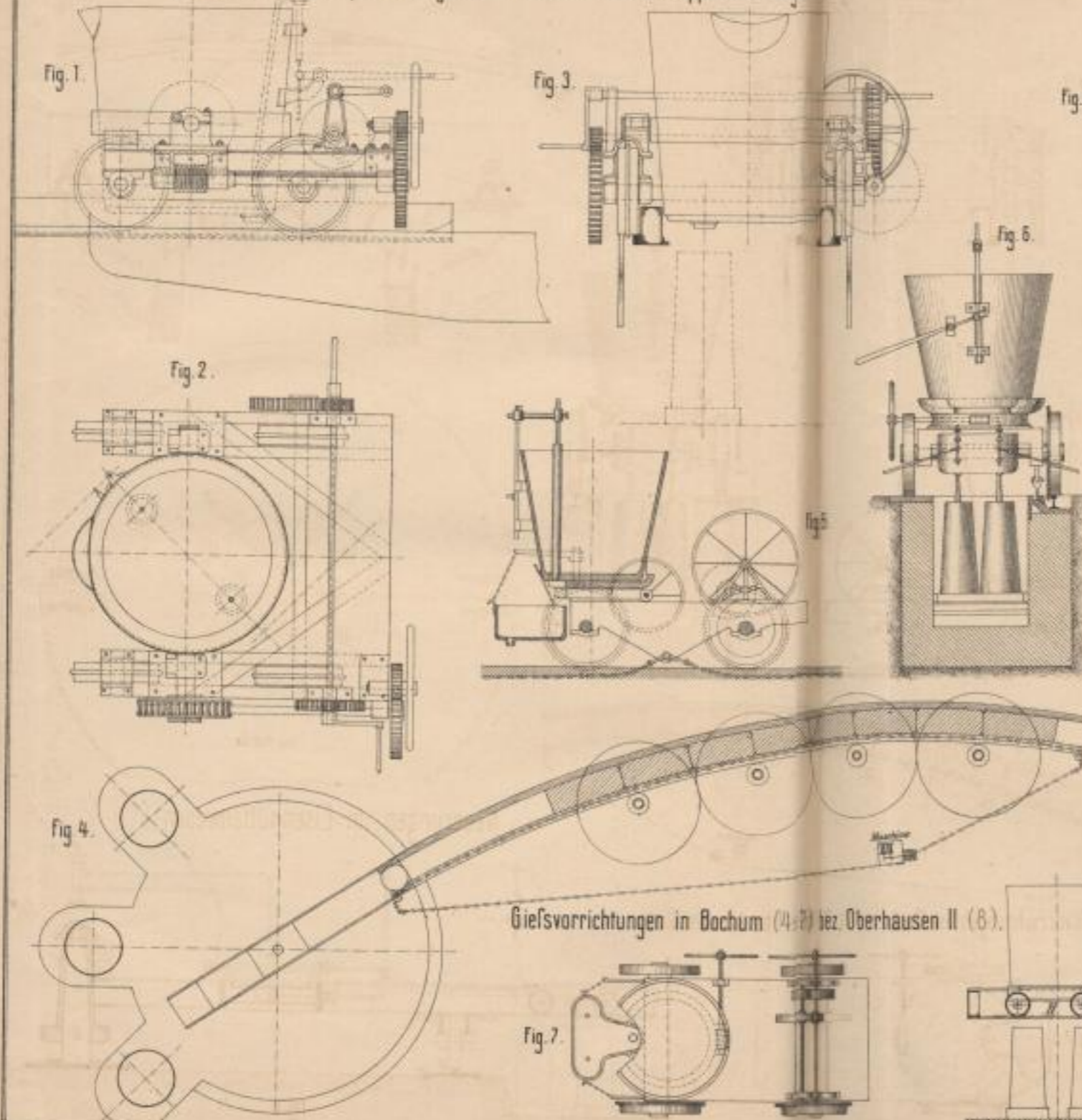

Gießvorrichtungen in Bochum (4-7) bez. Oberhausen II (8).

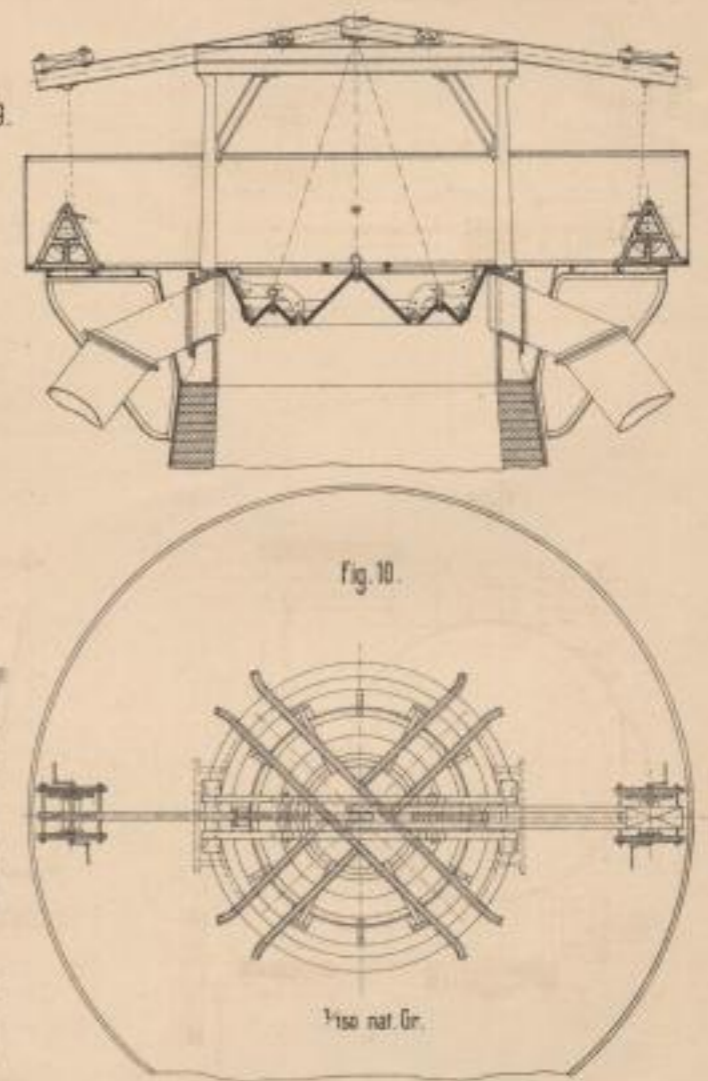

Neuerungen im Eisenhüttenwesen. (Taf 9)

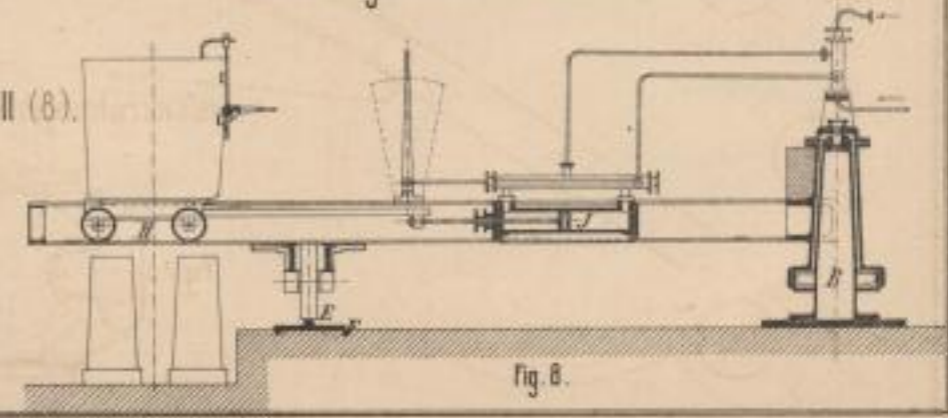

Lith. Anstalt v. F. W. Barmstedt

Neuerungen an Abstellvorrichtungen für Dampfmaschinen.

(Taf. 10)

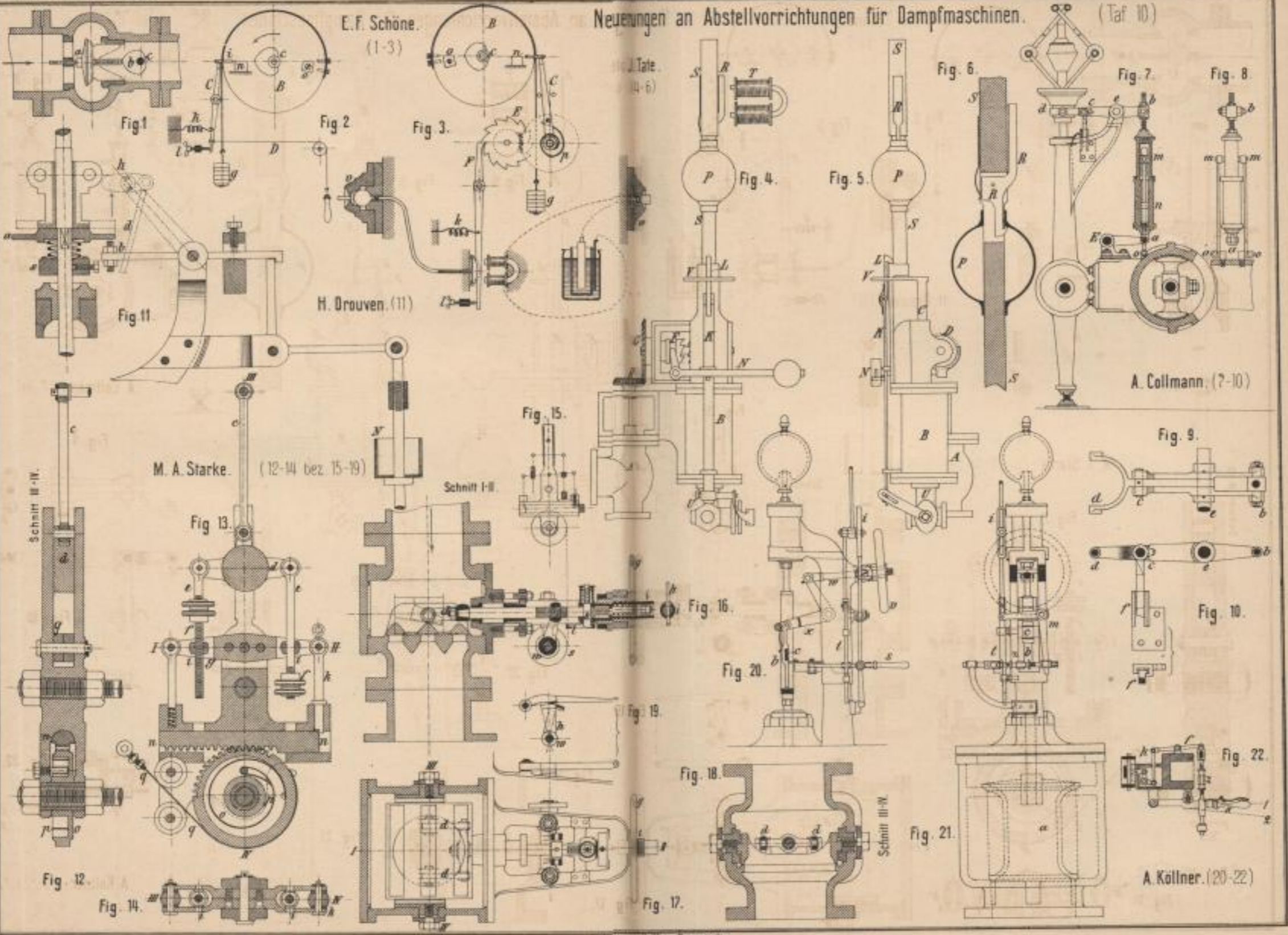

E. F. Schöne.
(1-3)

Taf.
10-6)

H. Drouven. (4)

A. Collmann. (7-10)

M. A. Starke. (12-14 bez. 15-19)

A. Köllner. (20-22)

Lith. Anst. v. W. Neumann, Neudamm.



Neuerungen an elektrischen Lampen u. a. (11)

Fr. Million. (1)

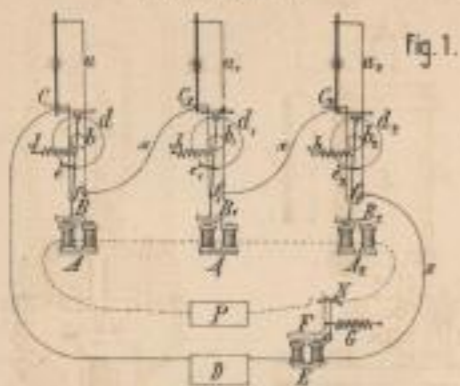

Fig. 1.

Otto Schulze. (2 u. 3)

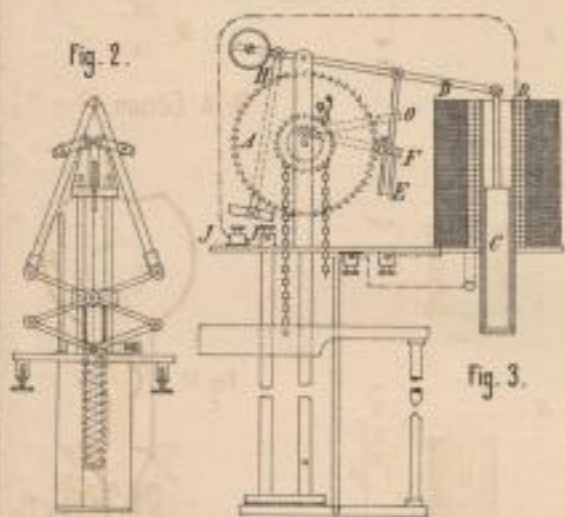

Fig. 2.

Fig. 3.

J. H. Guest. (8)

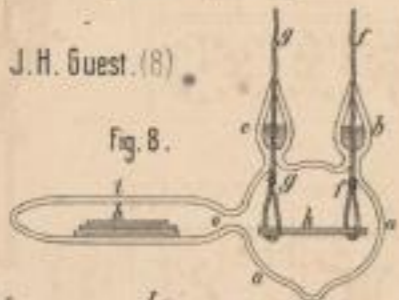

Fig. 8.

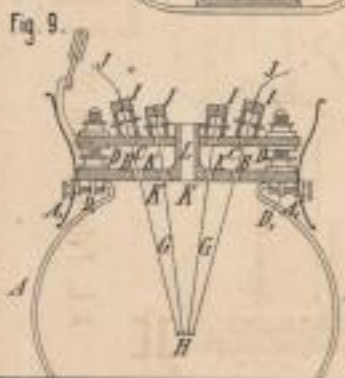

Fig. 9.

J. E. H. Gordon. (9)

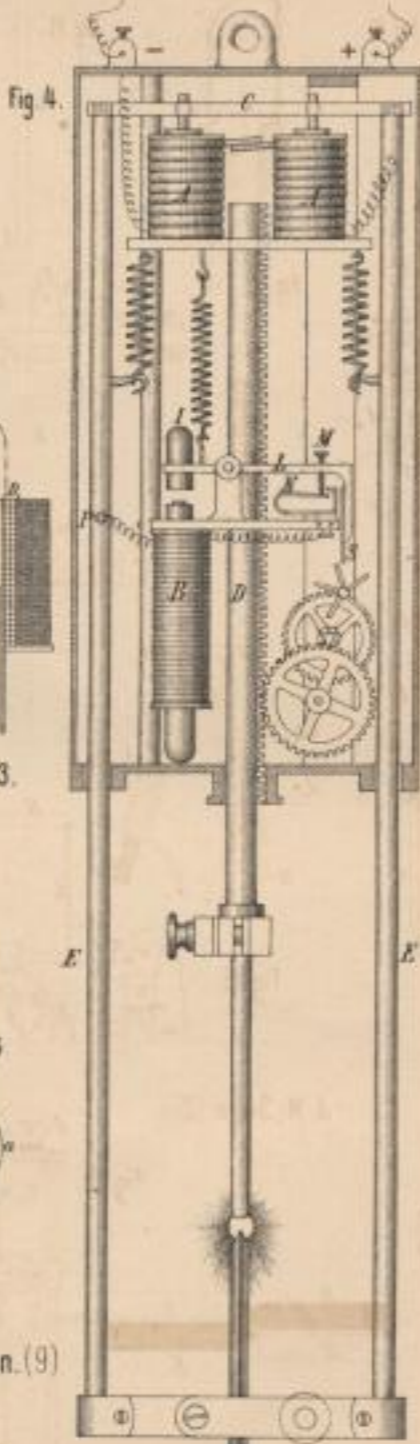

Fig. 4.

Gramme. (4)

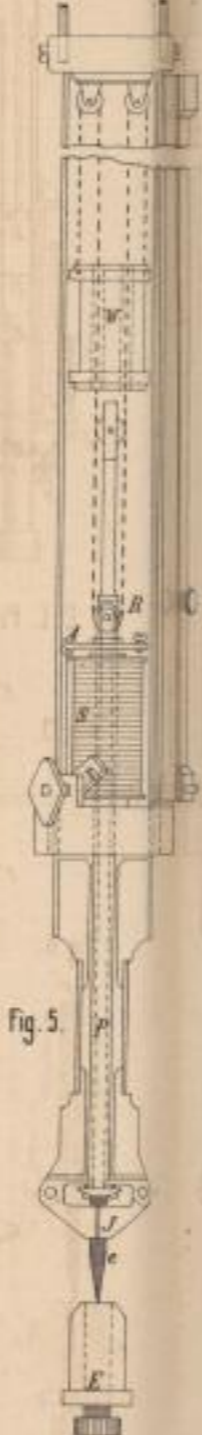

Fig. 5.

Joel. (5 u. 6)

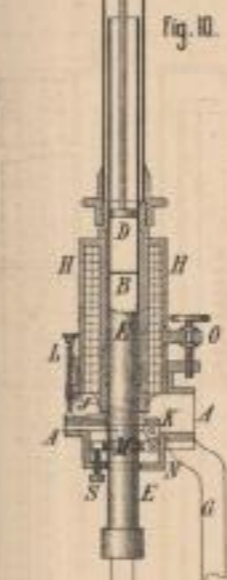

Fig. 10.

C. L. Pilleux. (13 u. 14)



Fig. 13.

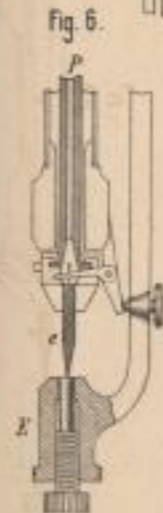

Fig. 6.



Fig. 12.

J. V. Nichols. (12)

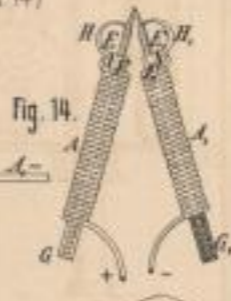

Fig. 14.

J. W. Swan. (15)



Fig. 7.

Delaye. (?)

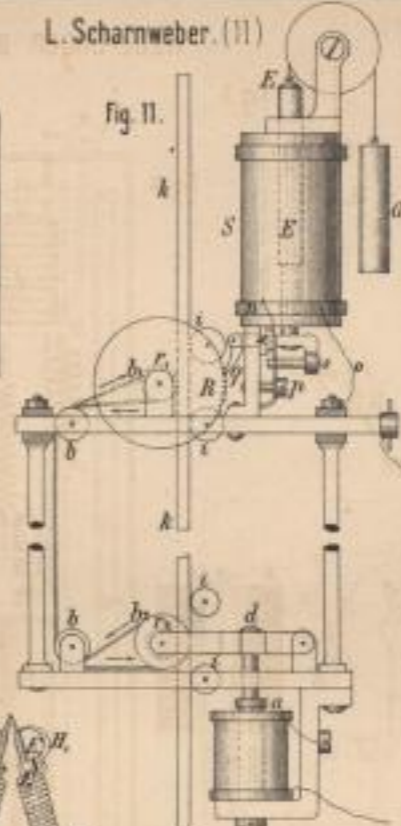

Fig. 11.

L. Scharnweber. (11)

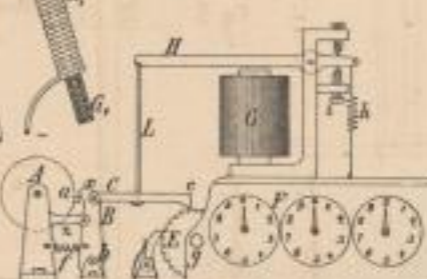

Fig. 15.

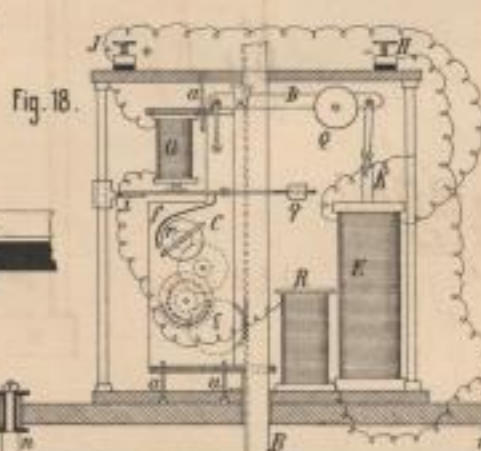

Fig. 18.

Fig. 16.

Th. A. Edison. (16 u. 17)

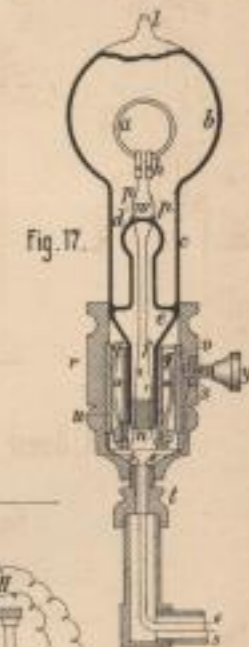
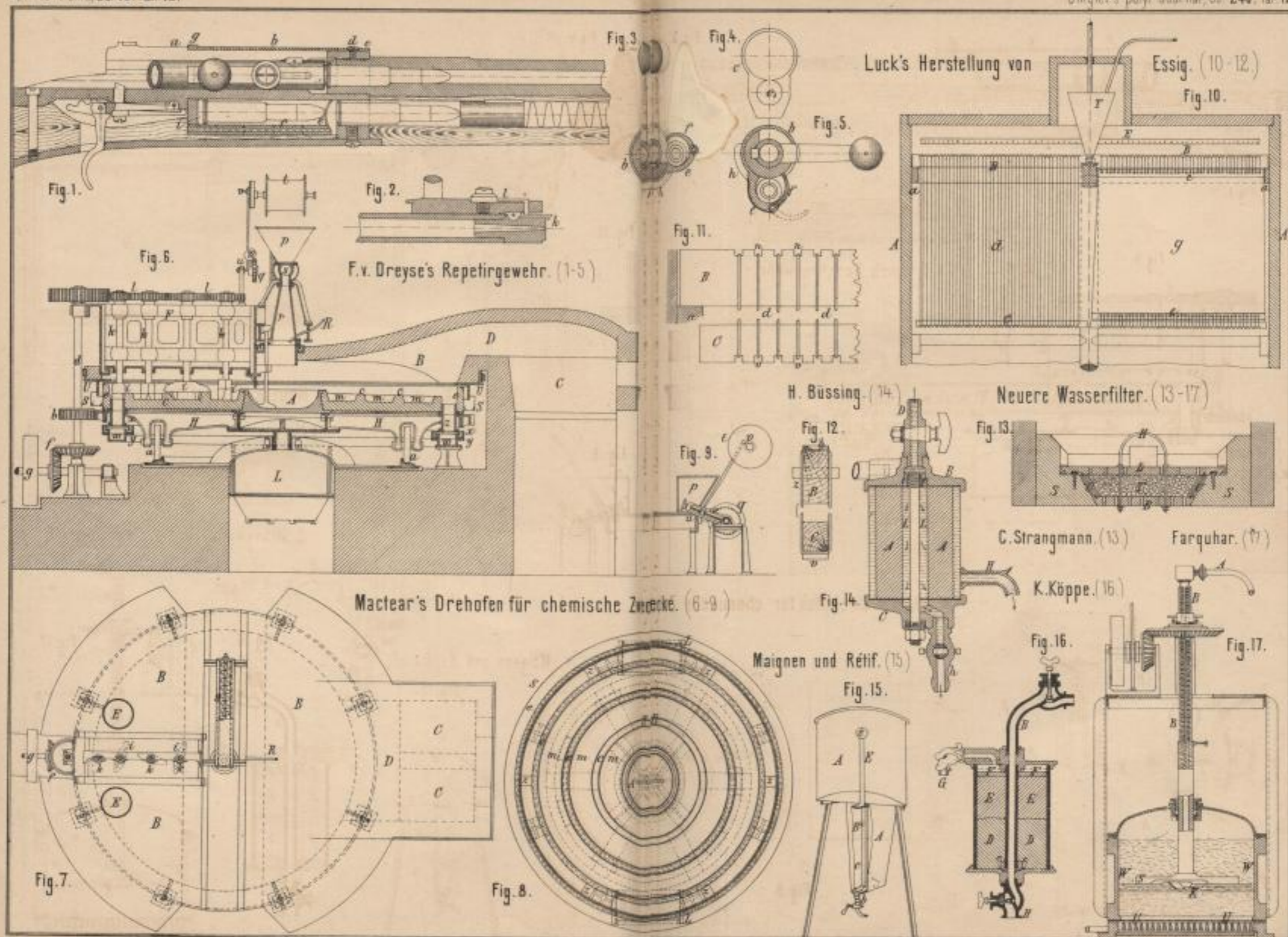

Fig. 17.

A. L. Fyfe u. J. Main. (18)

Lith. Anst. v. T. & W. Bernhardt.



F. v. Dreyse's Repetirgewehr. (1-5)

Mactear's Drehofen für chemische Zwecke. (6-9)

Luck's Herstellung von Essig. (10-12.) Fig. 10.

Neuere Wasserfilter. (13-17)

Maignen und Rétif. (15)

C. Strangmann. (13)

Farquhar. (17)

K. Köppe. (16)

Lith. Anstalt P. P. P. Darmstadt



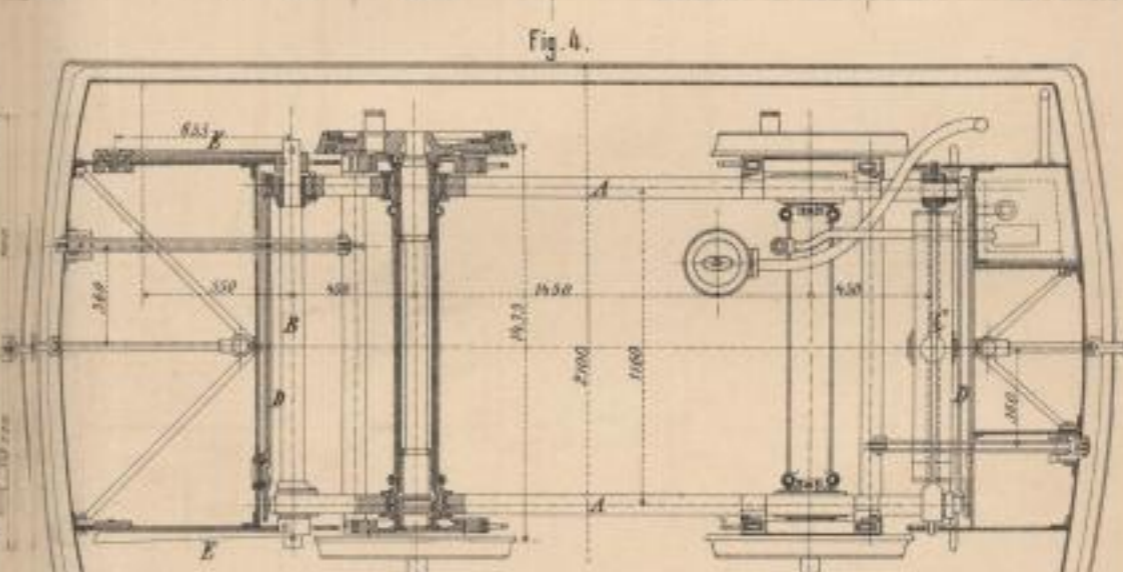
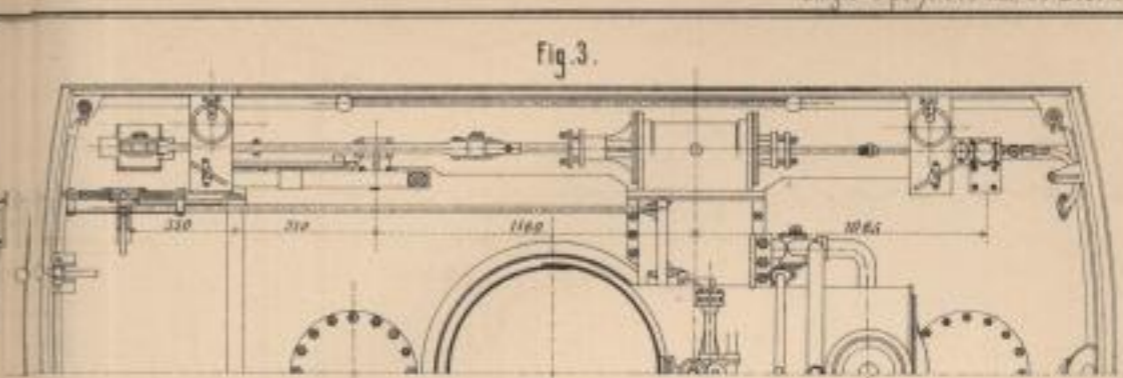
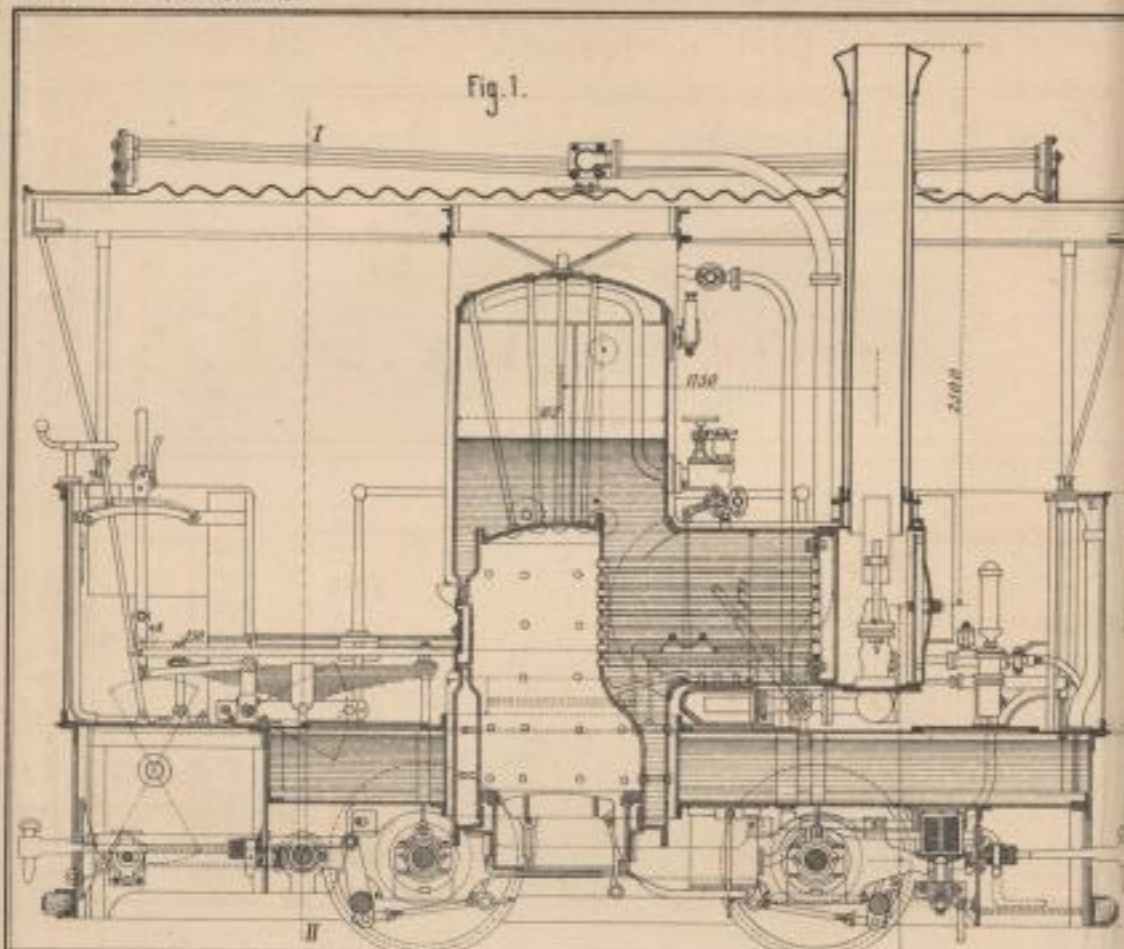

Ch. Brown's Strafsenbahn- Locomotive der Schweizerischen Locomotiv- und Maschinenfabrik. (Taf. 13)

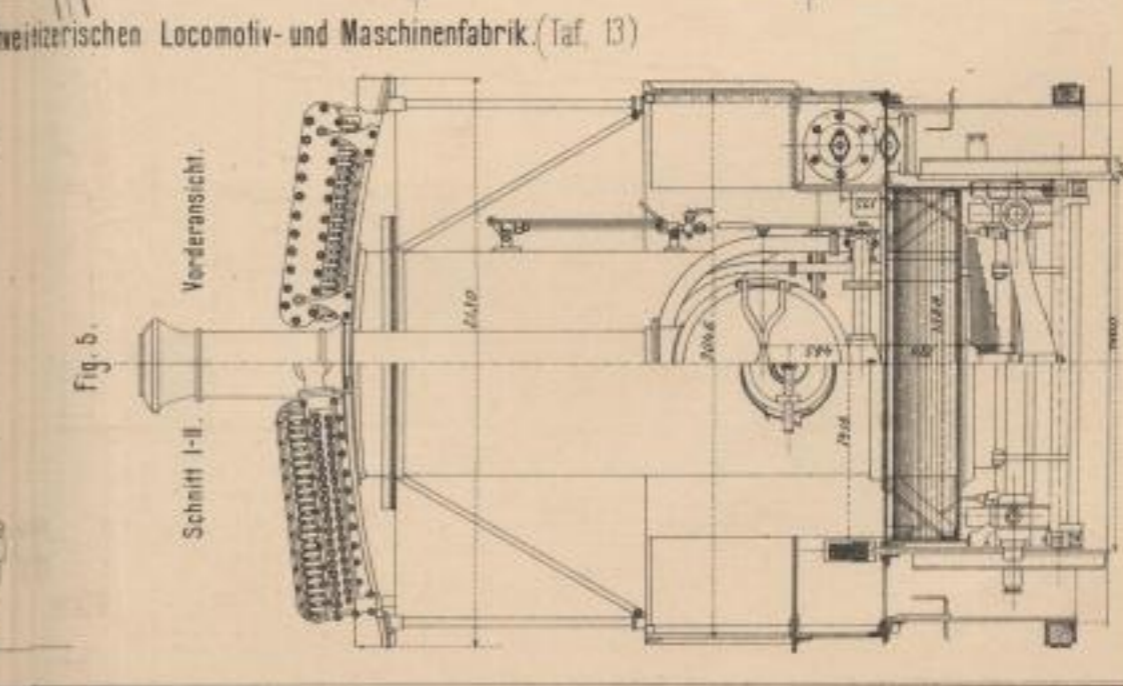
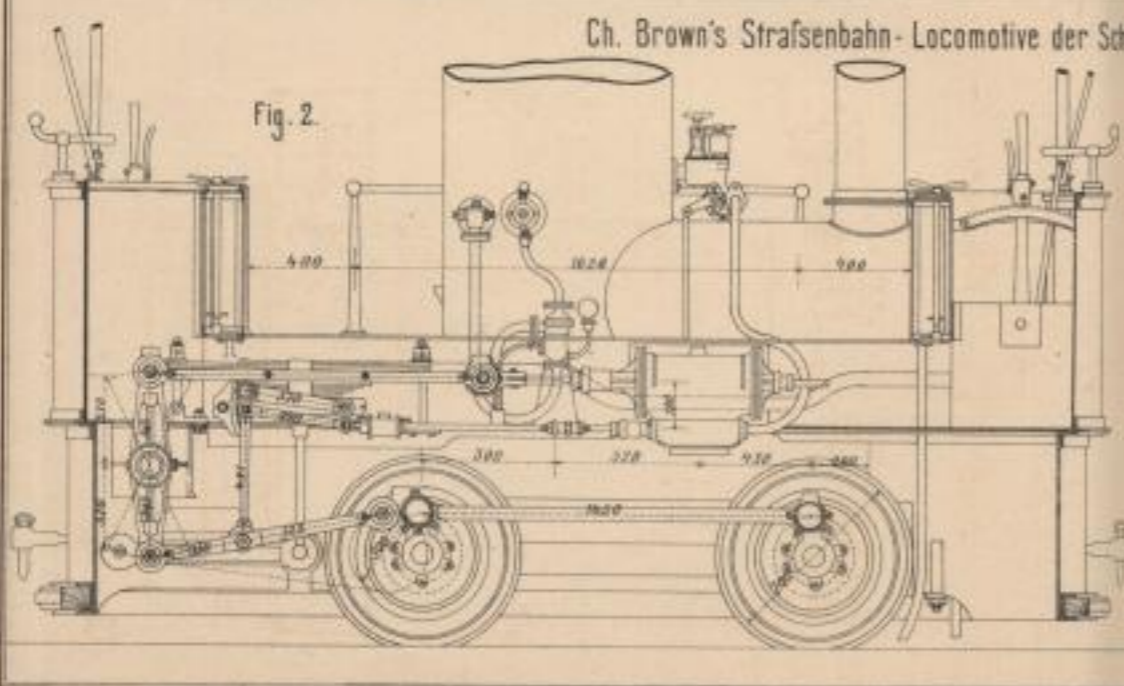

Lith. Anstalt v. K. & W. v. Metz, Darmstadt.

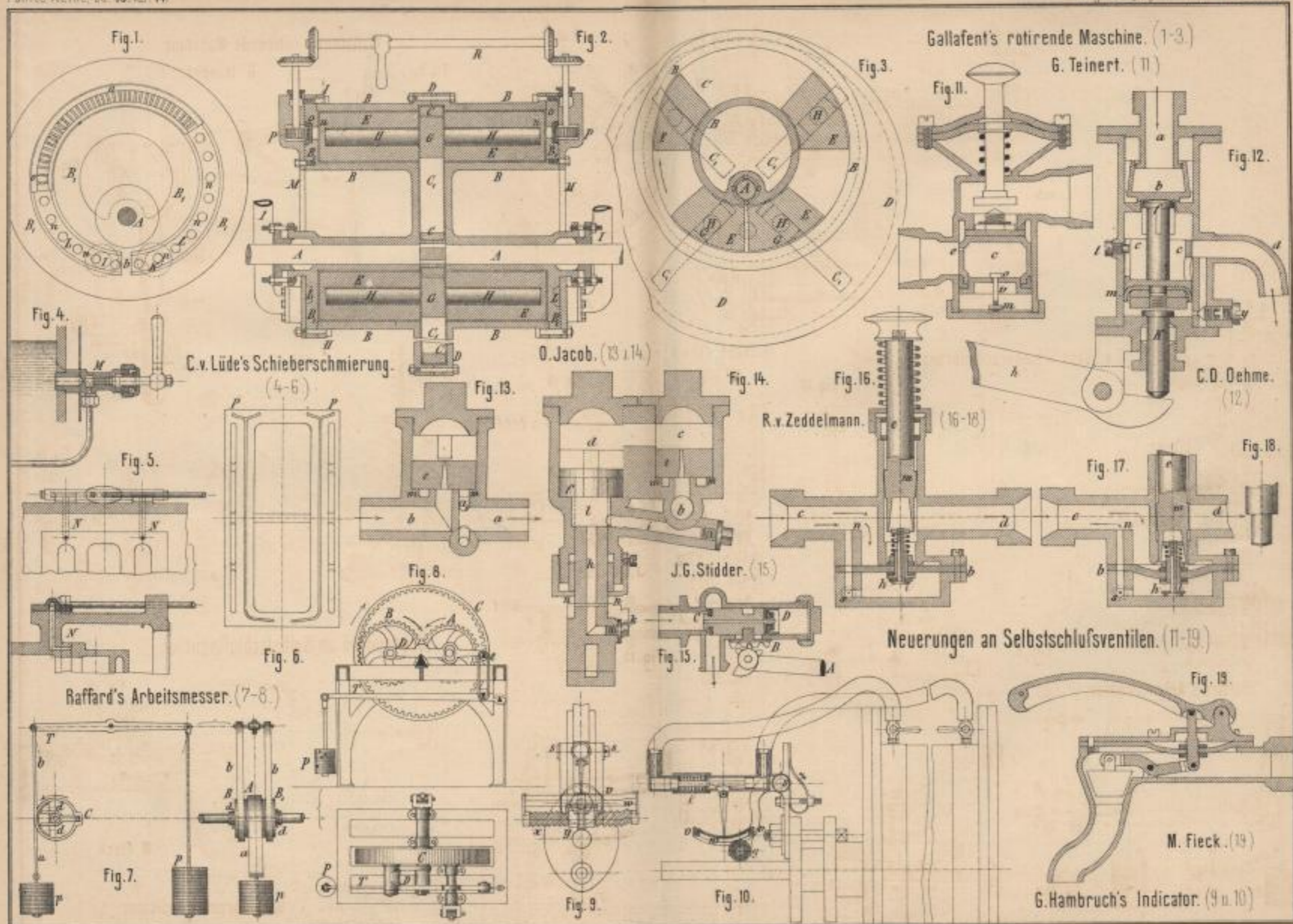

Lith. Anstalt v. P. W. W. Darmstadt.

Neuerungen an Wirkereimaschinen. (Taf. 15)

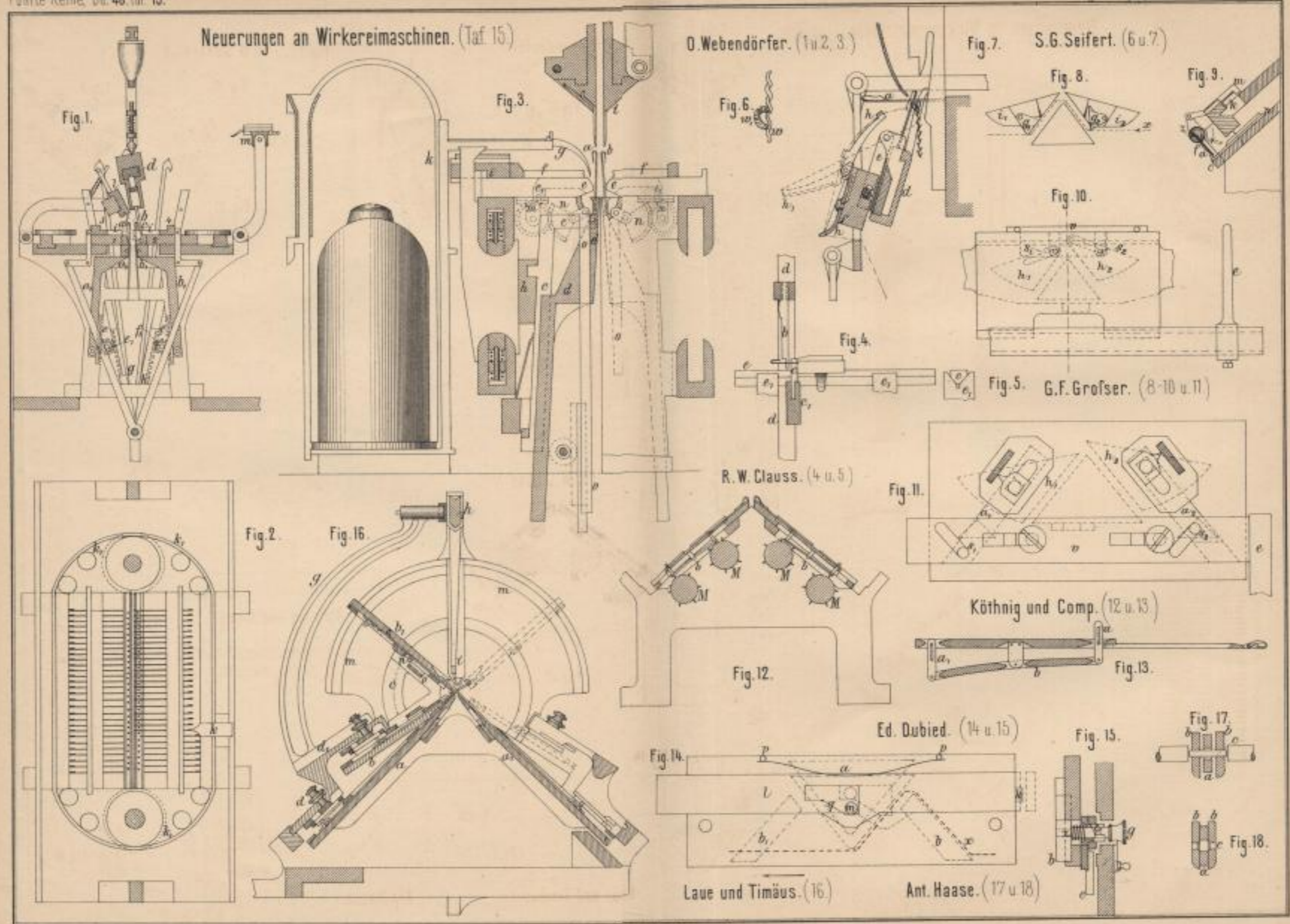

Lith. Anstalt v. F. W. G. Darmstadt

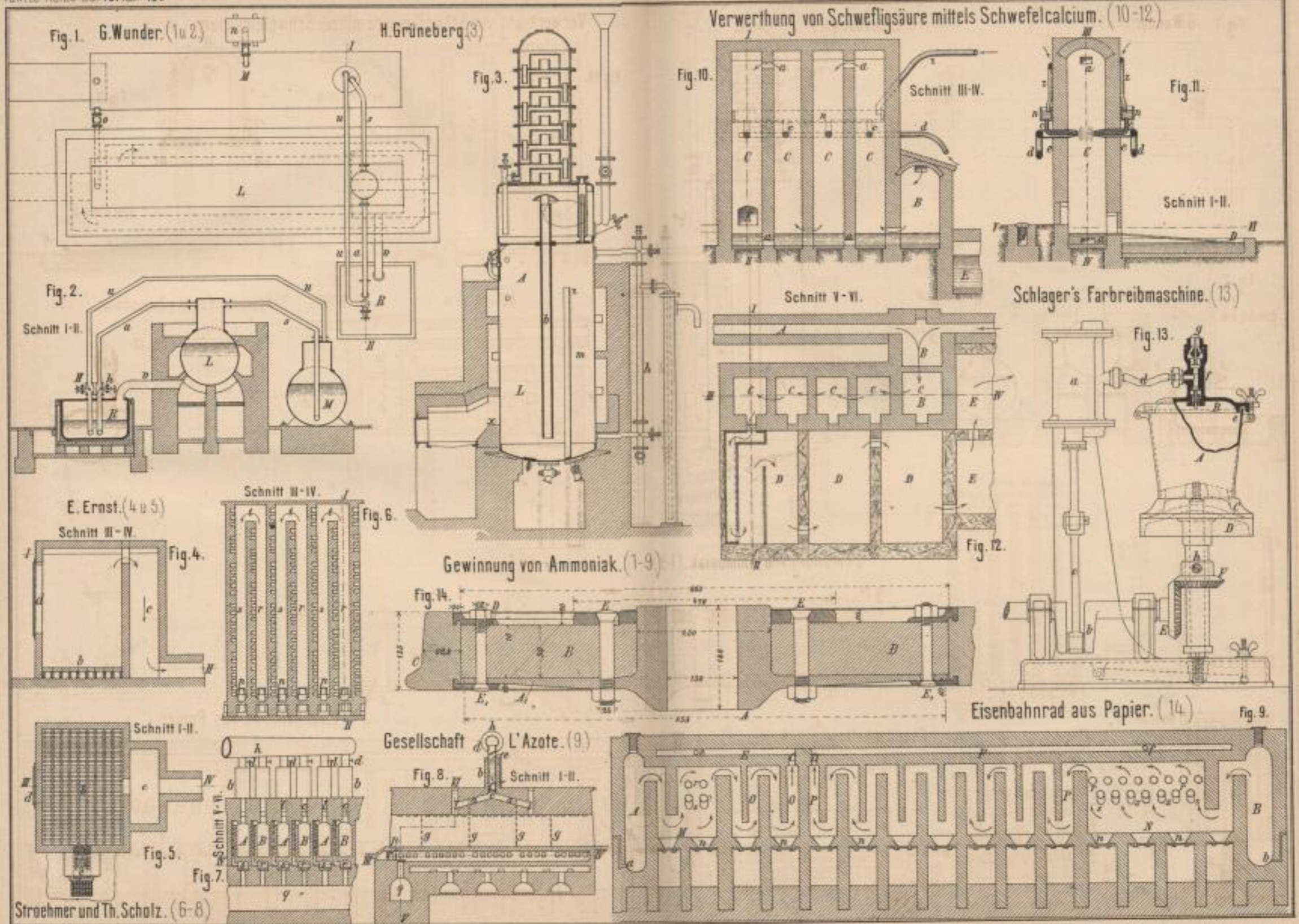

Lith. Anst. v. H. v. Dornsch.

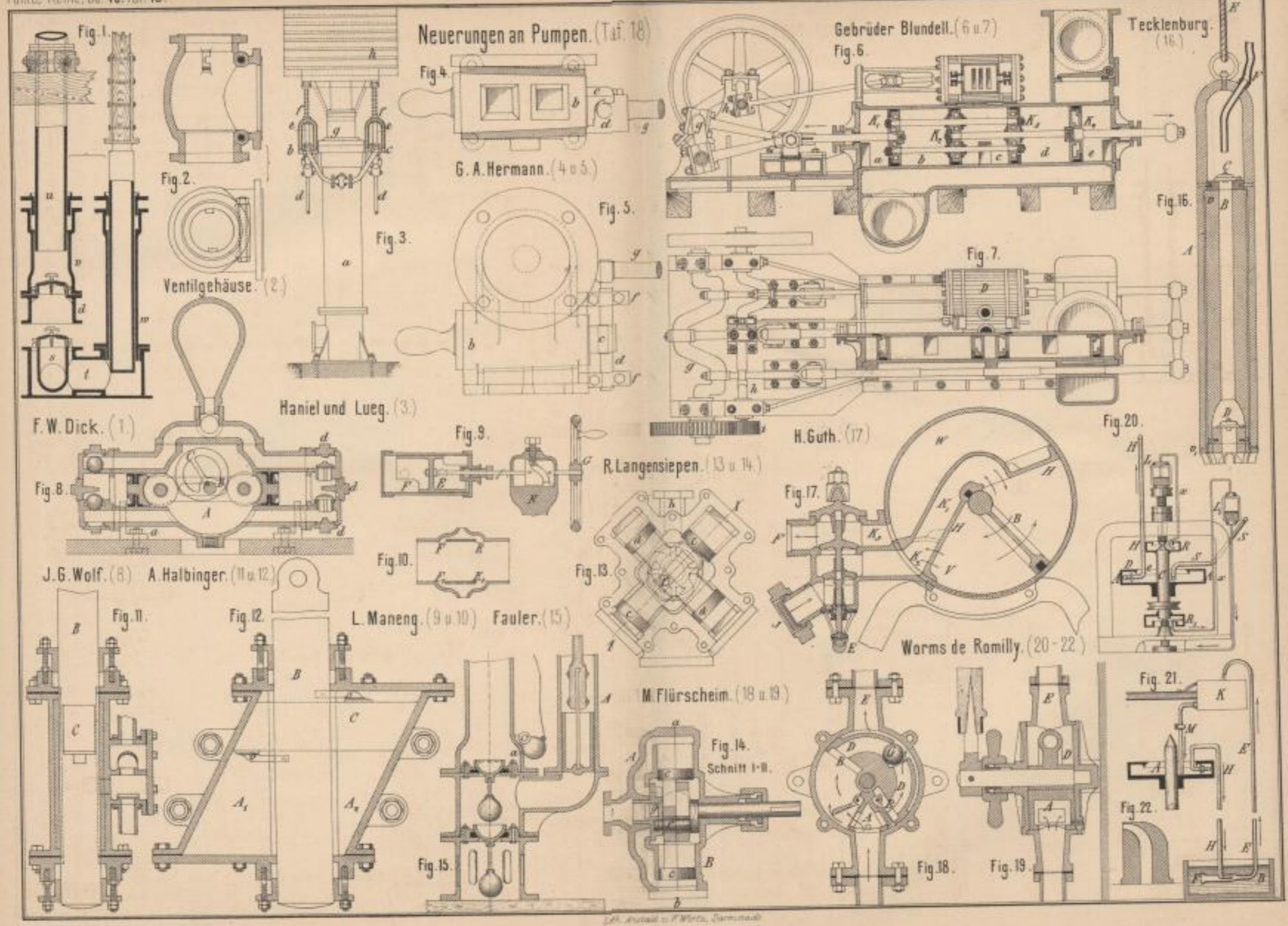

Warrall, Elwell und Middleton's Schienensäge. (1 u. 2)

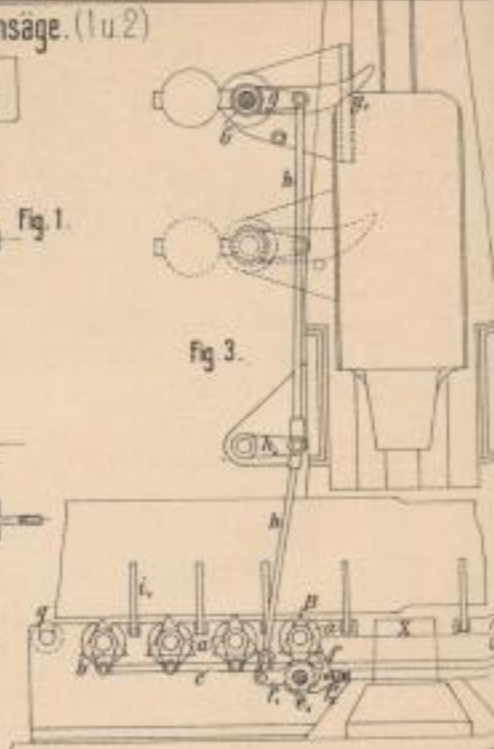
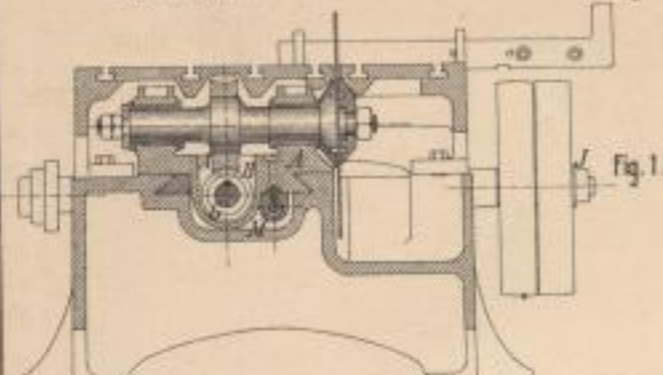

Mure's Schmiedemaschine. (3-6)

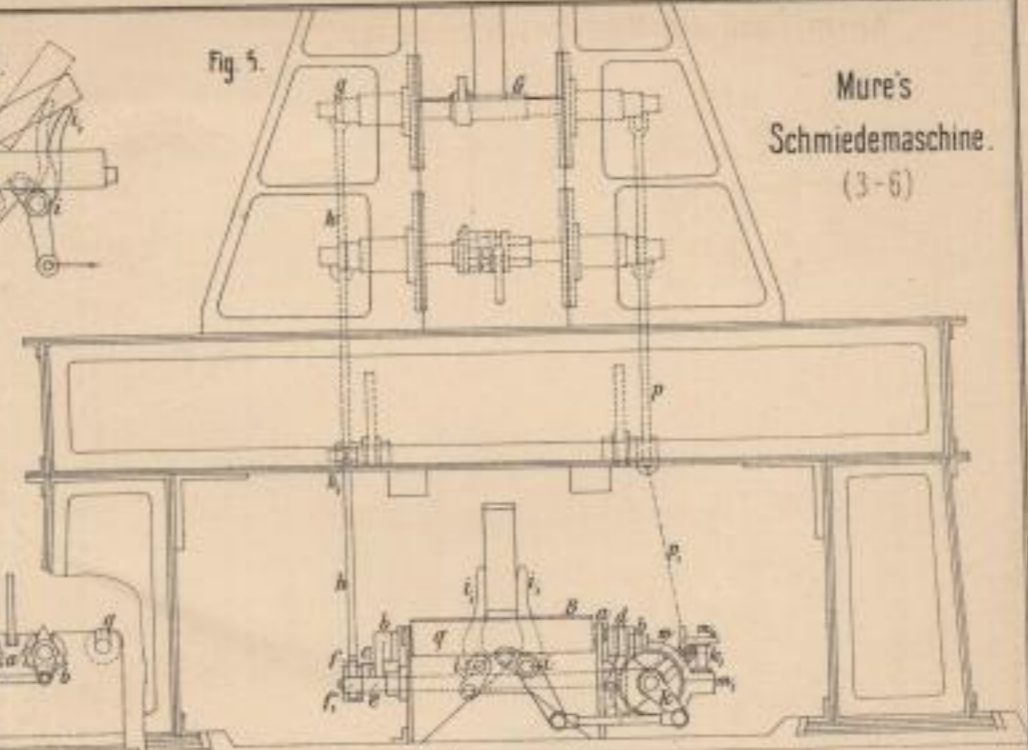

Stellwag's Gasverdichtungsapparat. (10)

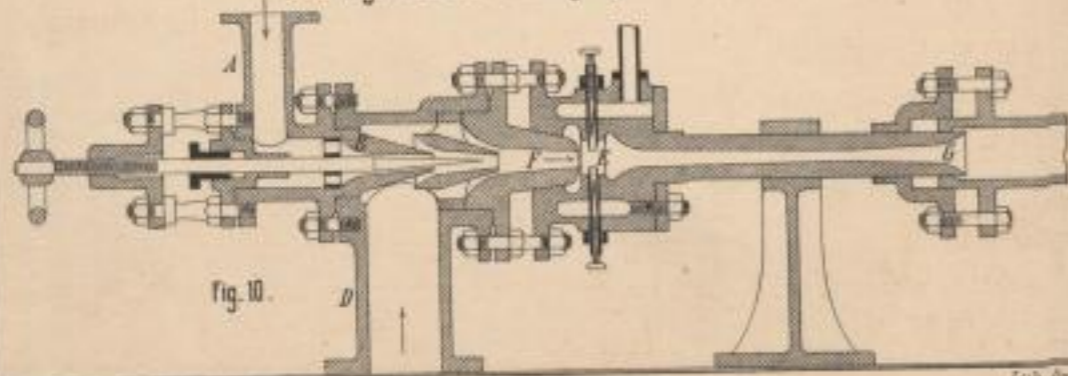

Fig. 6.

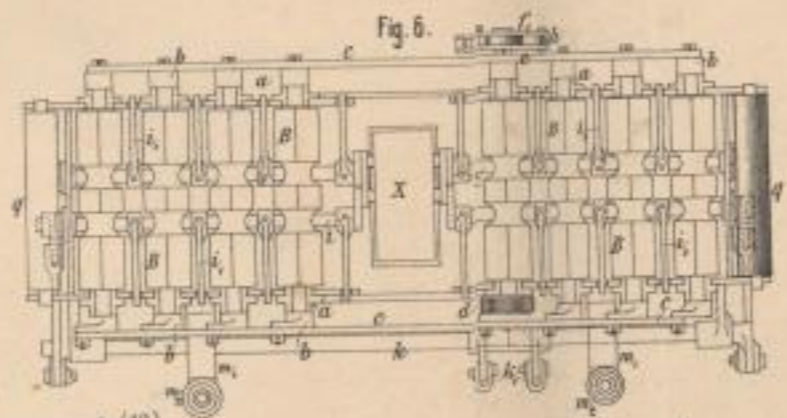
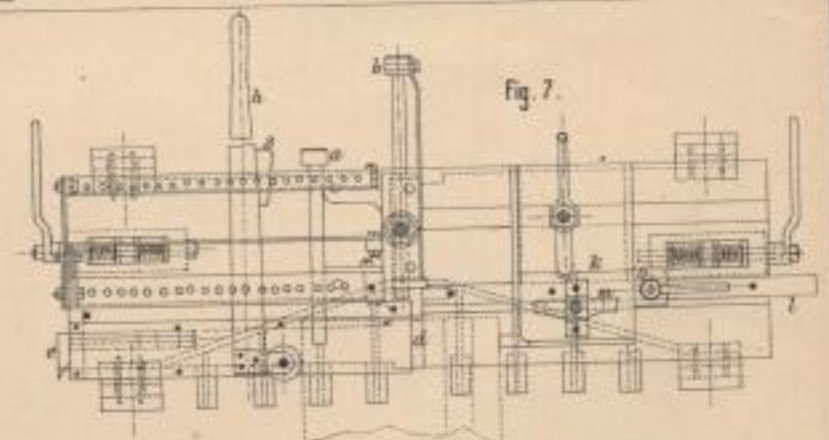
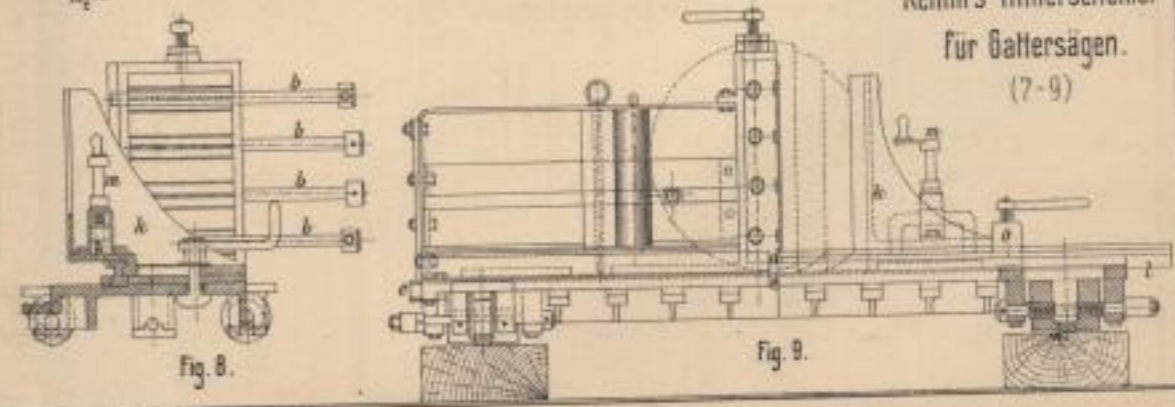

Fig. 7.



Kemm's Hinterschemel für Gattersägen. (7-9)



Lehr. Inst. v. F. Wörstl, Darmstadt.

Salinen mit Gasfeuerung für Torf und Braunkohle.
(Taf. 20)

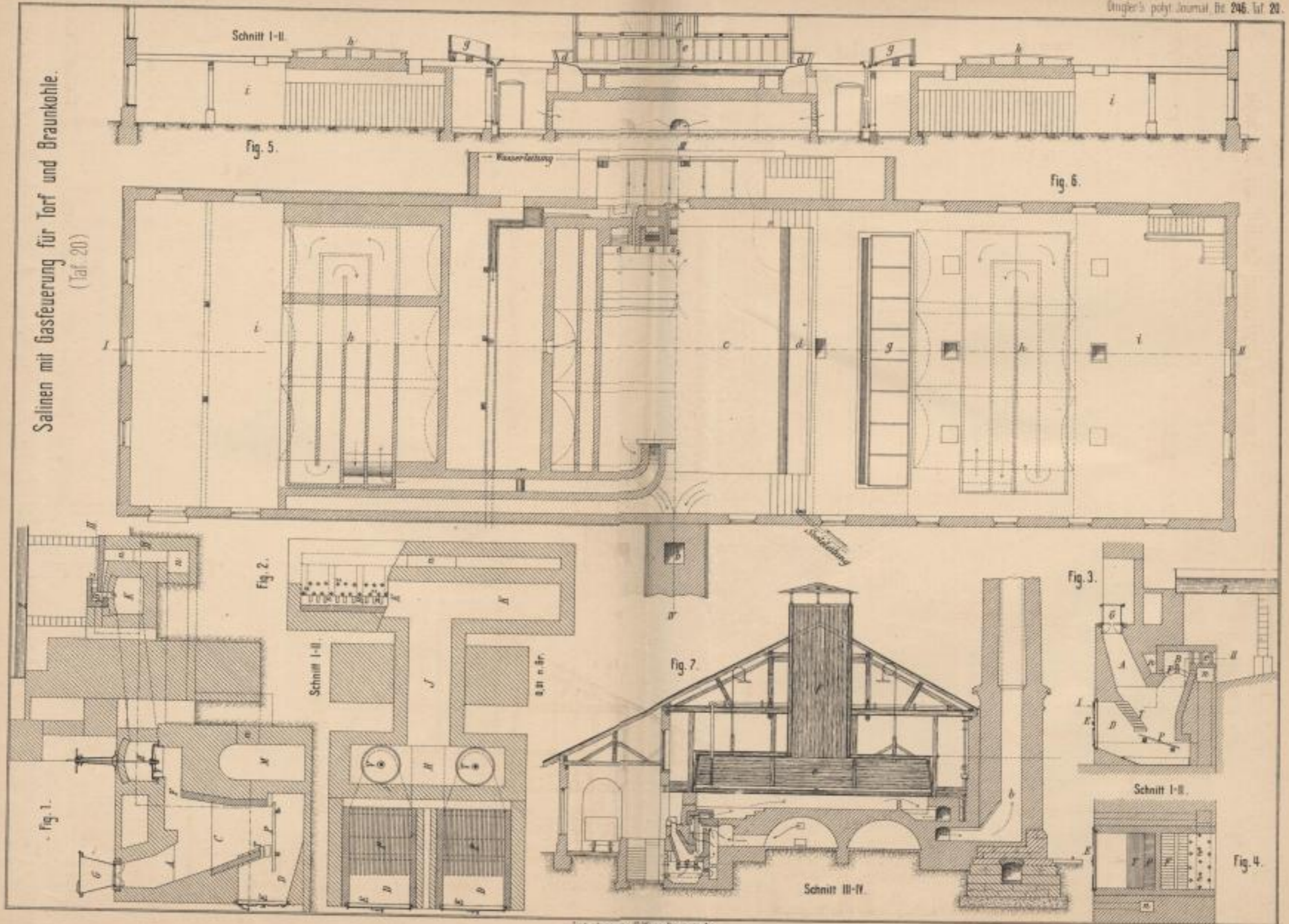

Arch. Anst. v. P. Witt, Darmstadt.

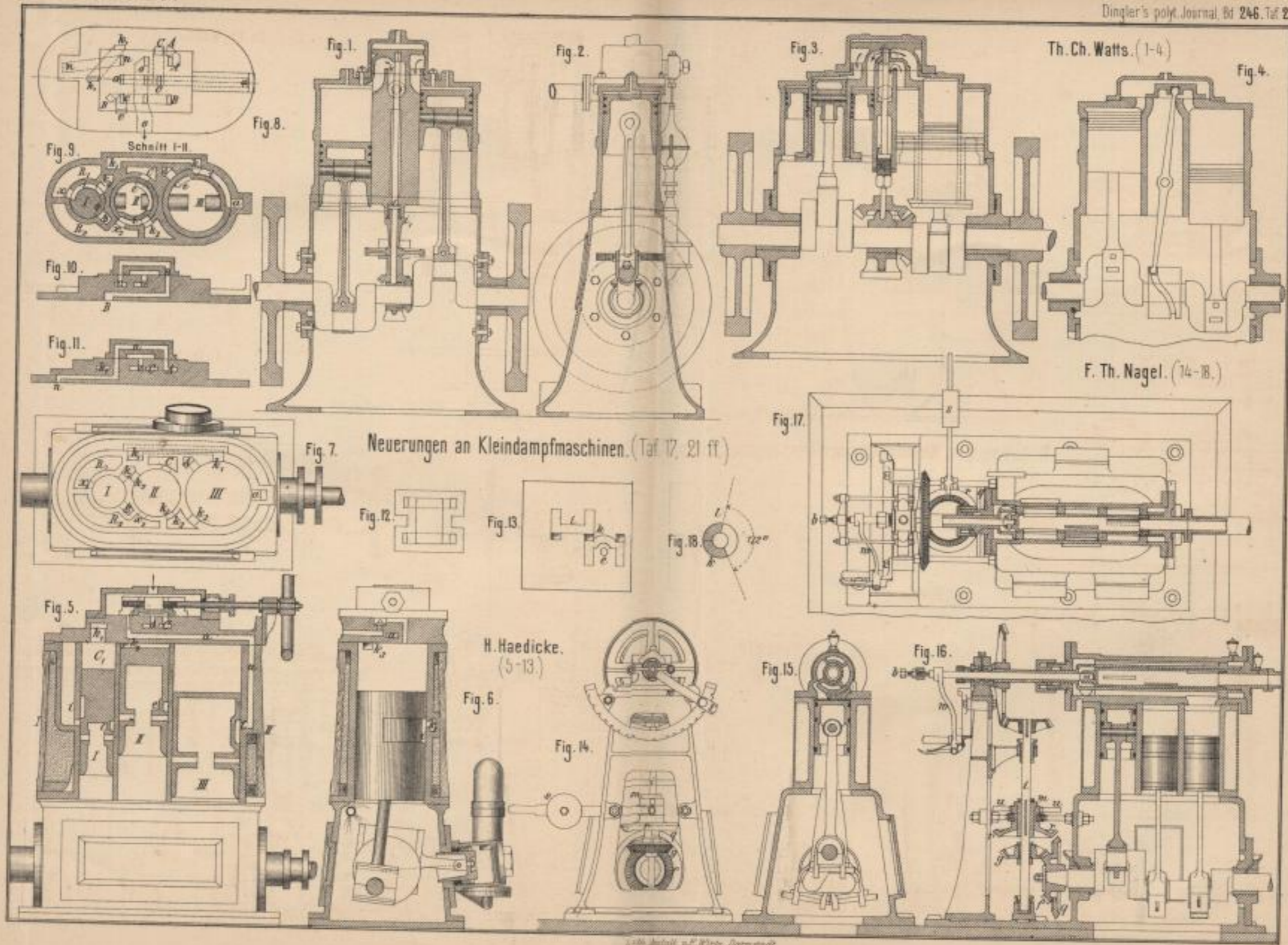

Lehrstuhl v. P. W. v. D. v. M.

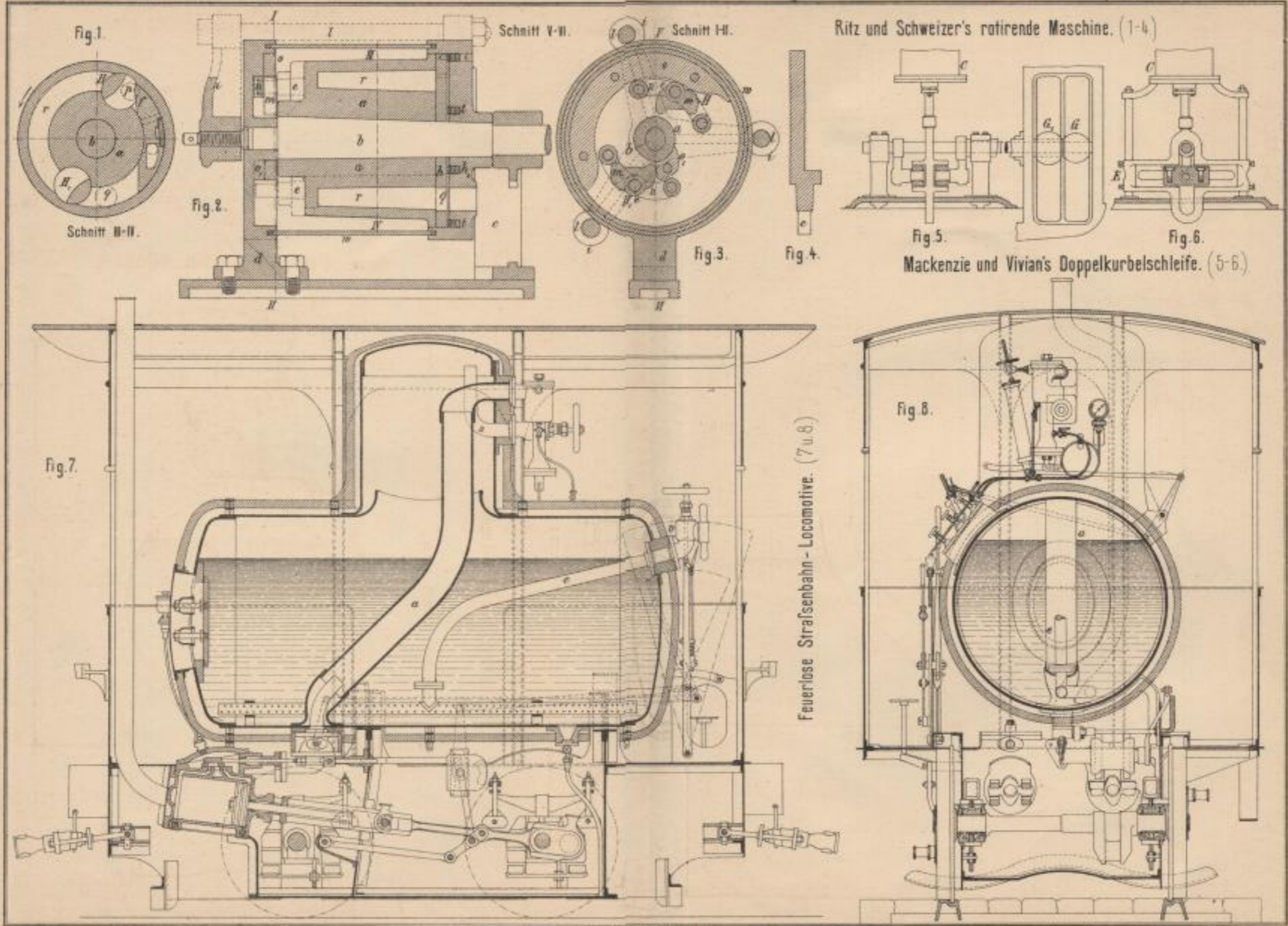

Fig. 1.

Fig. 2.

Fig. 3.

Fig. 4.

Fig. 5.

Fig. 6.

Fig. 8.

Fig. 7.

Schnitt V-II.

Schnitt III.

Schnitt III-II.

Ritz und Schweizer's rotirende Maschine. (1-4)

Mackenzie und Vivian's Doppelkurbelschleife. (5-6)

Feuerlose Strafsenbahn - Locomotive. (7 u. 8)

Leib. Anstalt v. P. W. v. Dornwaldt.



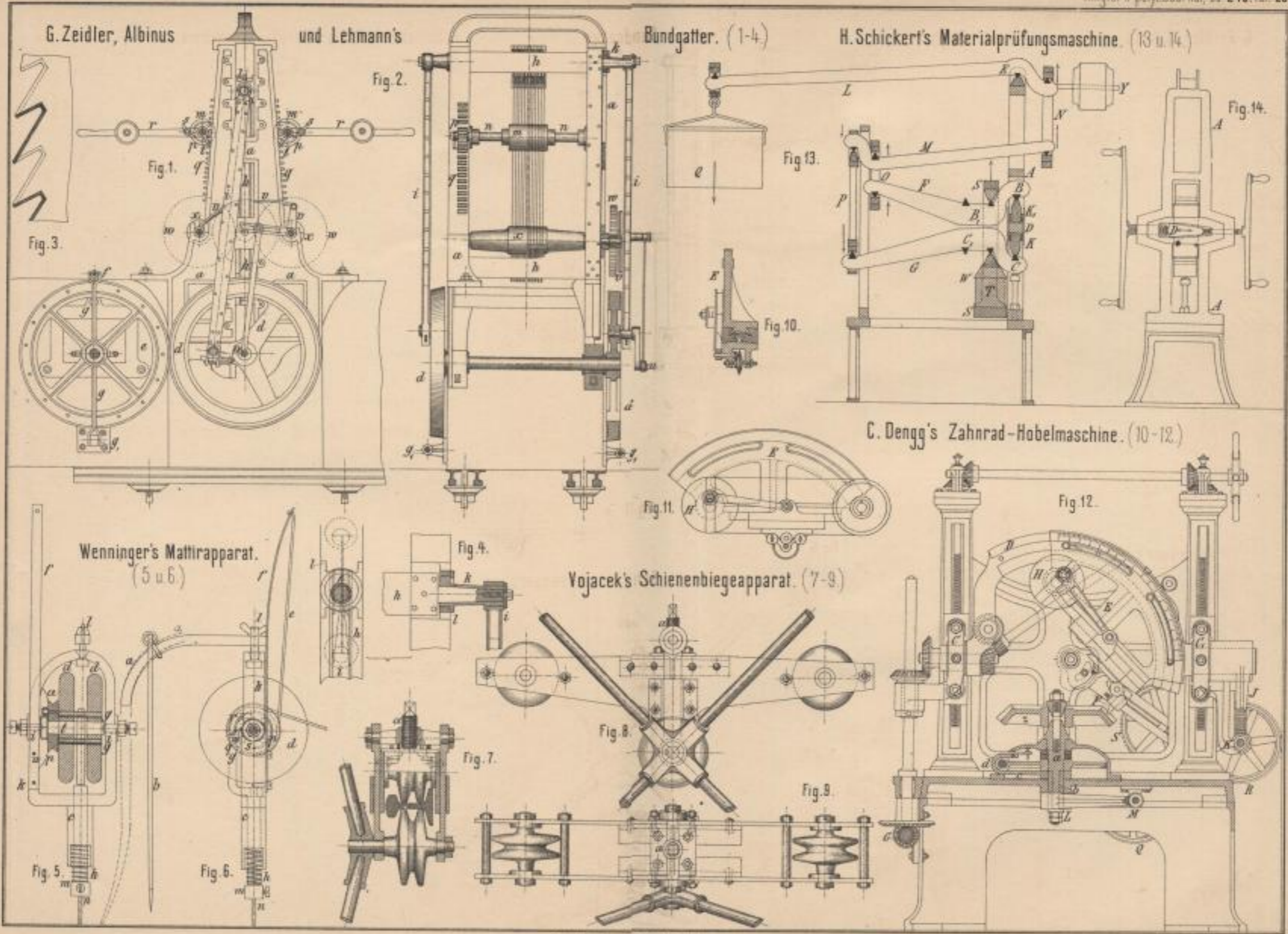

Lith. Anstalt v. F. Fricke, Darmstadt.

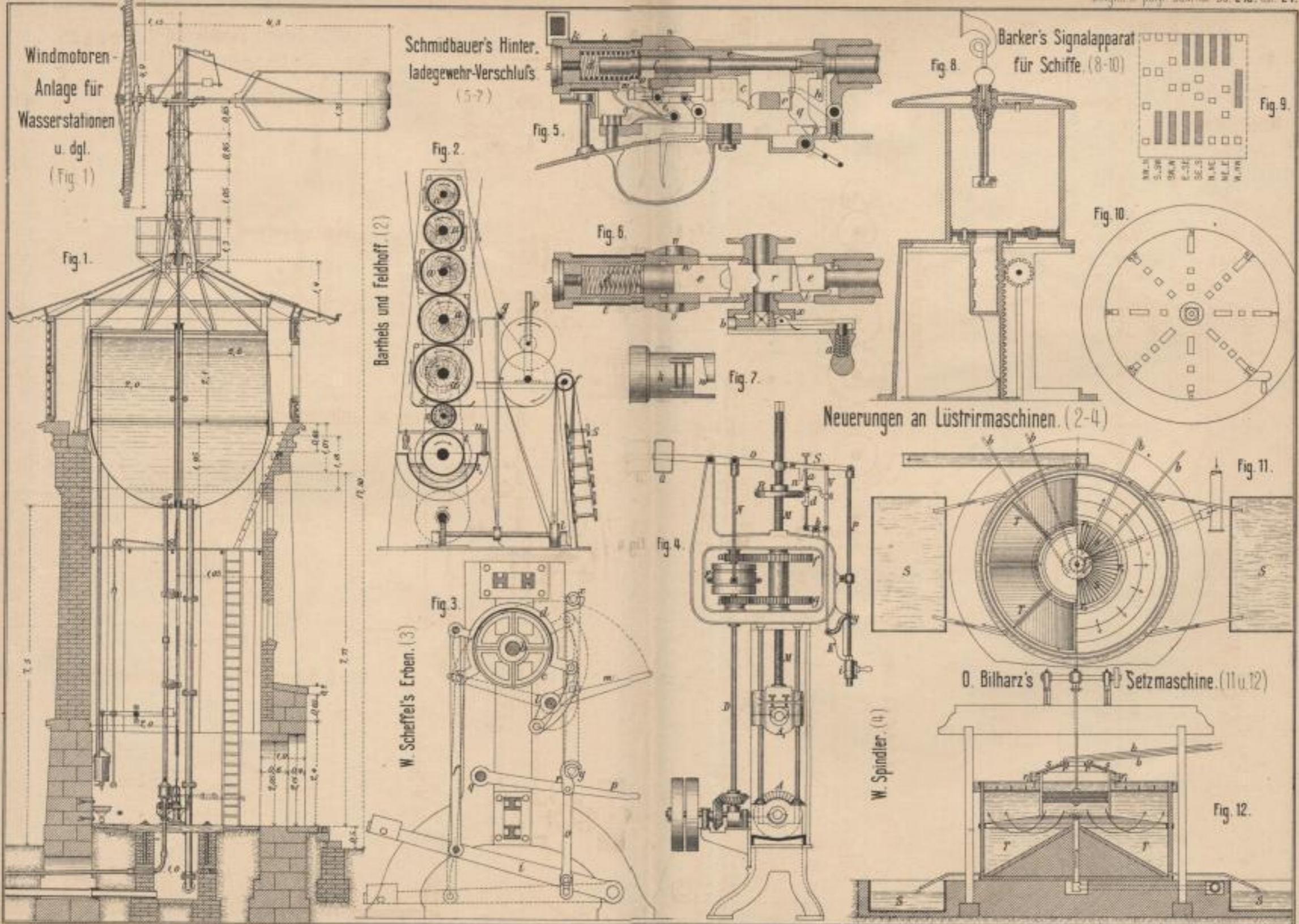

Lith. Anst. v. P. Nees, Darmstadt.

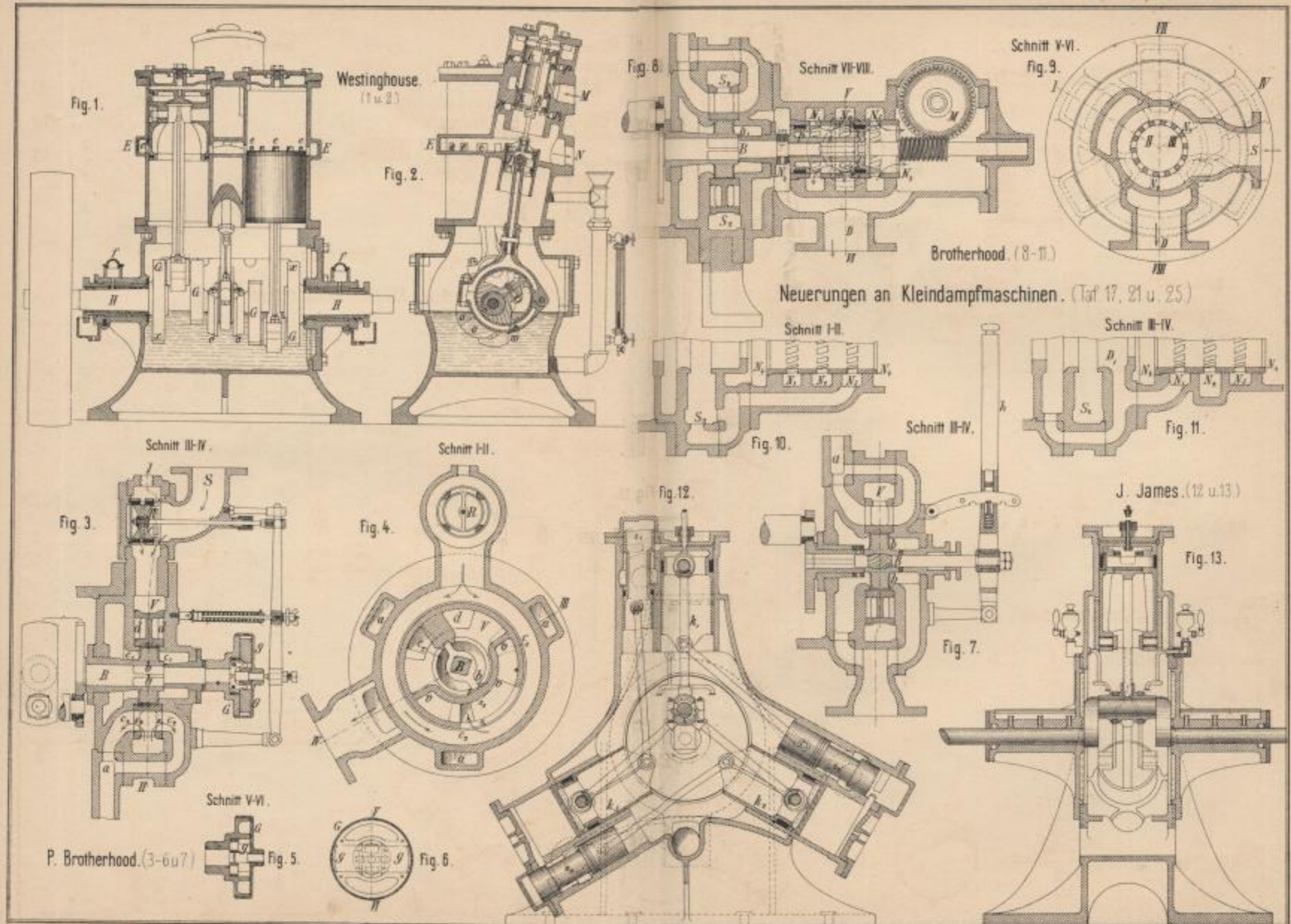

Lith. Anst. v. P. Wirtz, Darmstadt

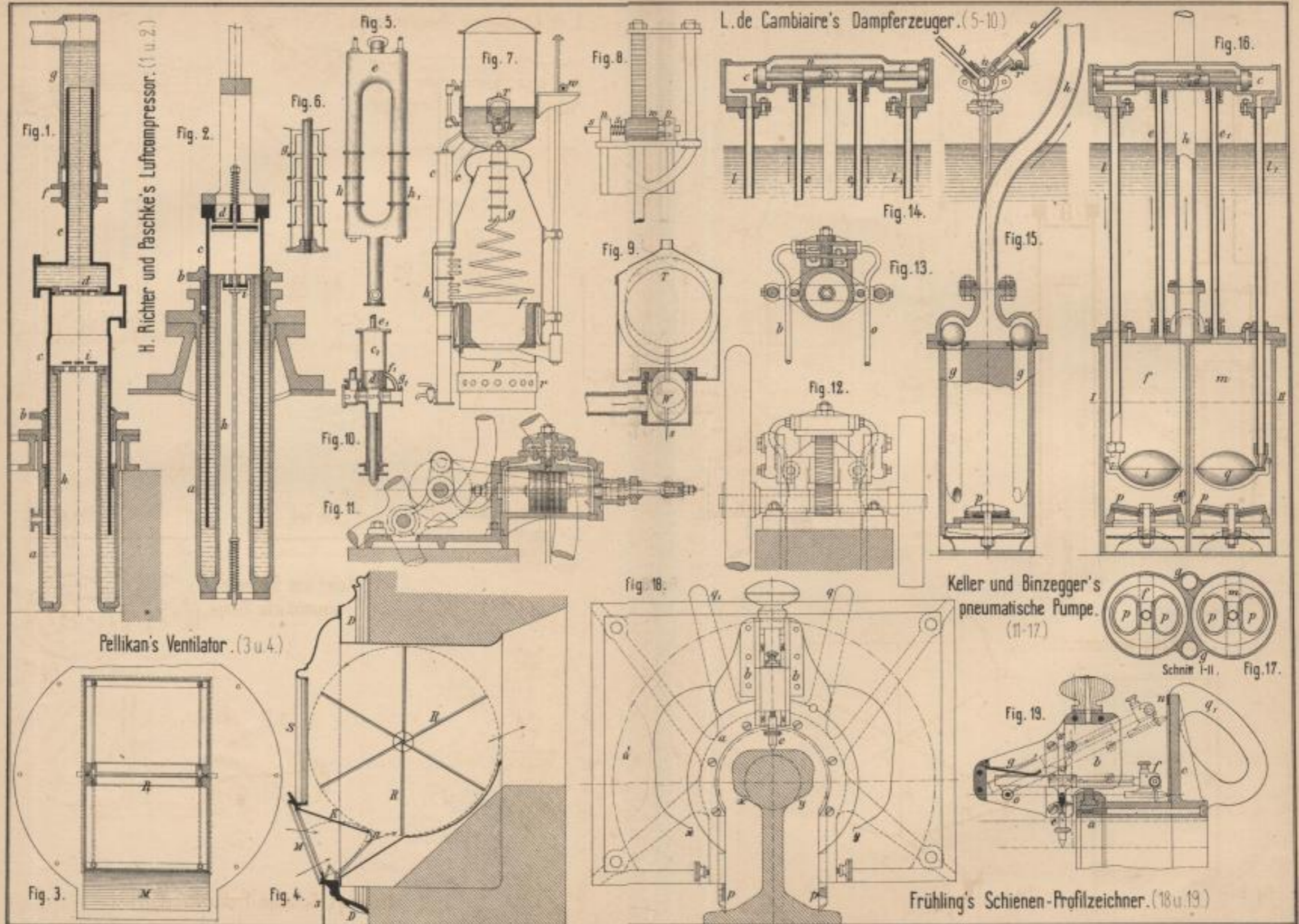

Lith. Anst. v. P. J. Neumann

C. Sachs' hydraulische Druckregulirung für Walzwerke. (1-10)

Fielding und Platt's Aufbiegpressen. (11 u. 12.)

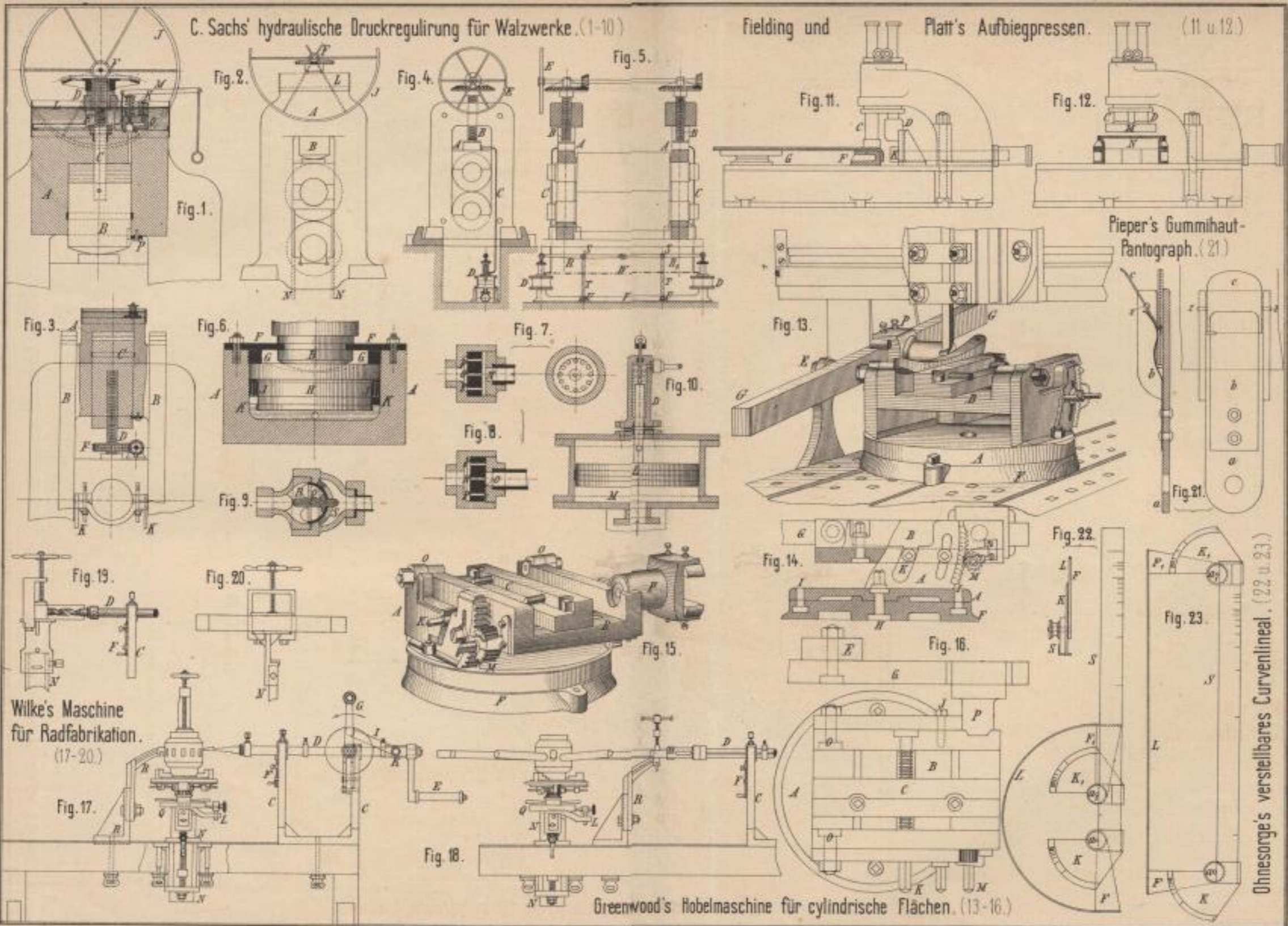

Lith. Anst. v. F. W. Neumann



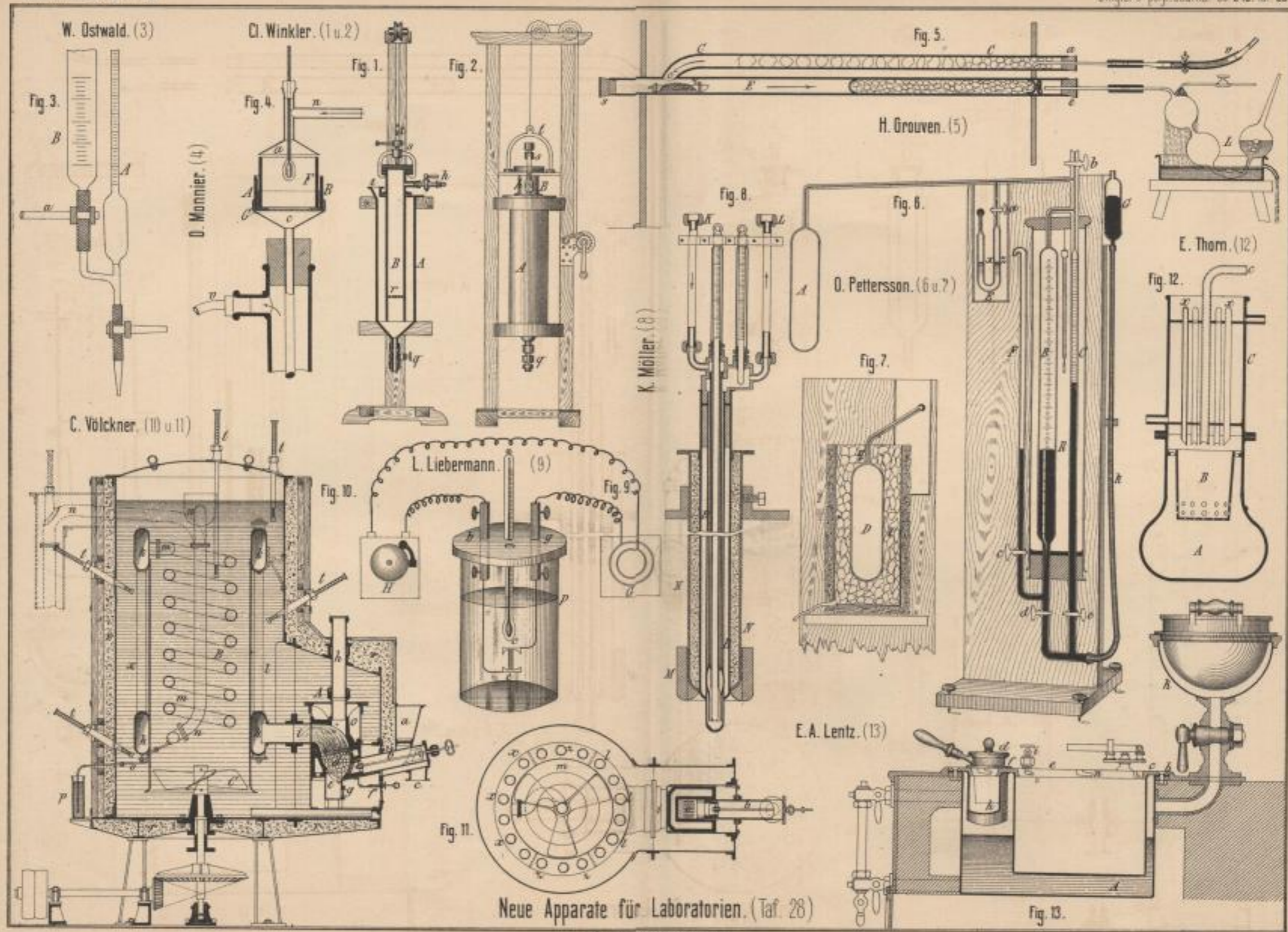

Neue Apparate für Laboratorien. (Taf. 28)

Lith. Anst. v. F. Wirtz, Darmstadt.

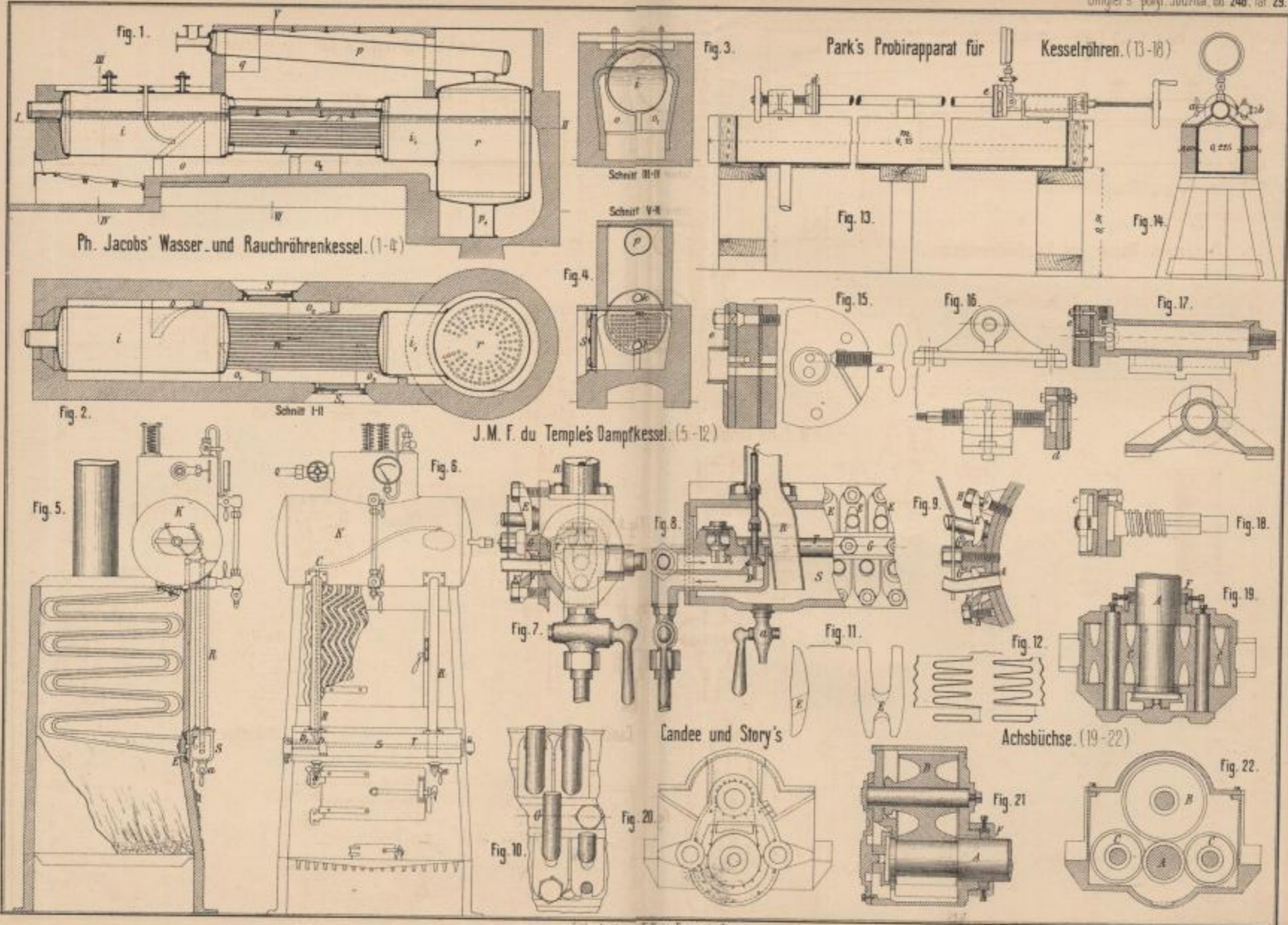

Ph. Jacobs' Wasser- und Rauchröhrenkessel. (1-4)

J. M. F. du Temple's Dampfessel. (5-12)

Park's Probirapparat für Kesselröhren. (13-18)

Candee und Story's

Achsbüchse. (19-22)

Lith. Anst. v. F. W. v. Dornstadt.

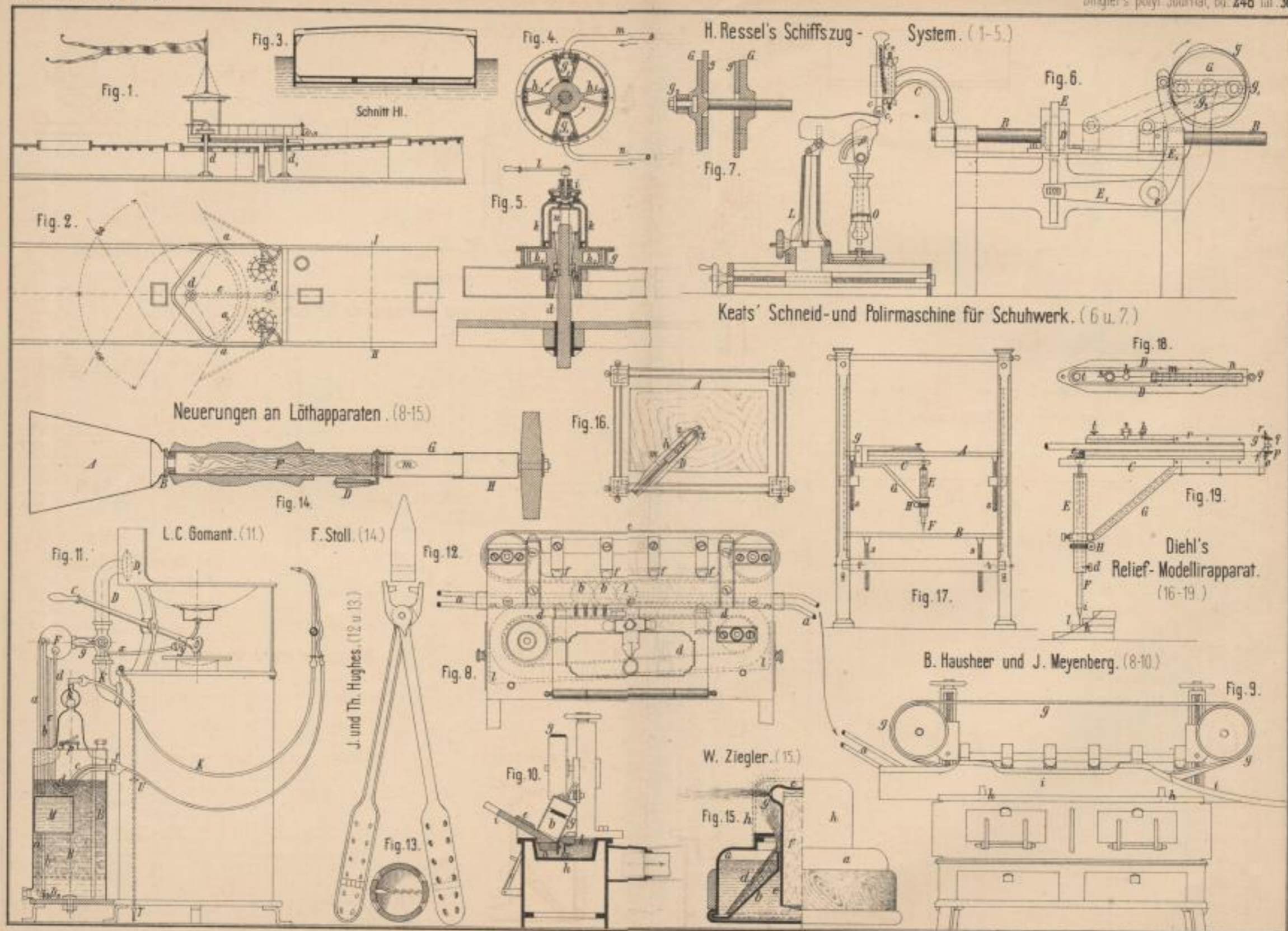

Tab. aus d. J. 1871, D. 1871, D. 1871.

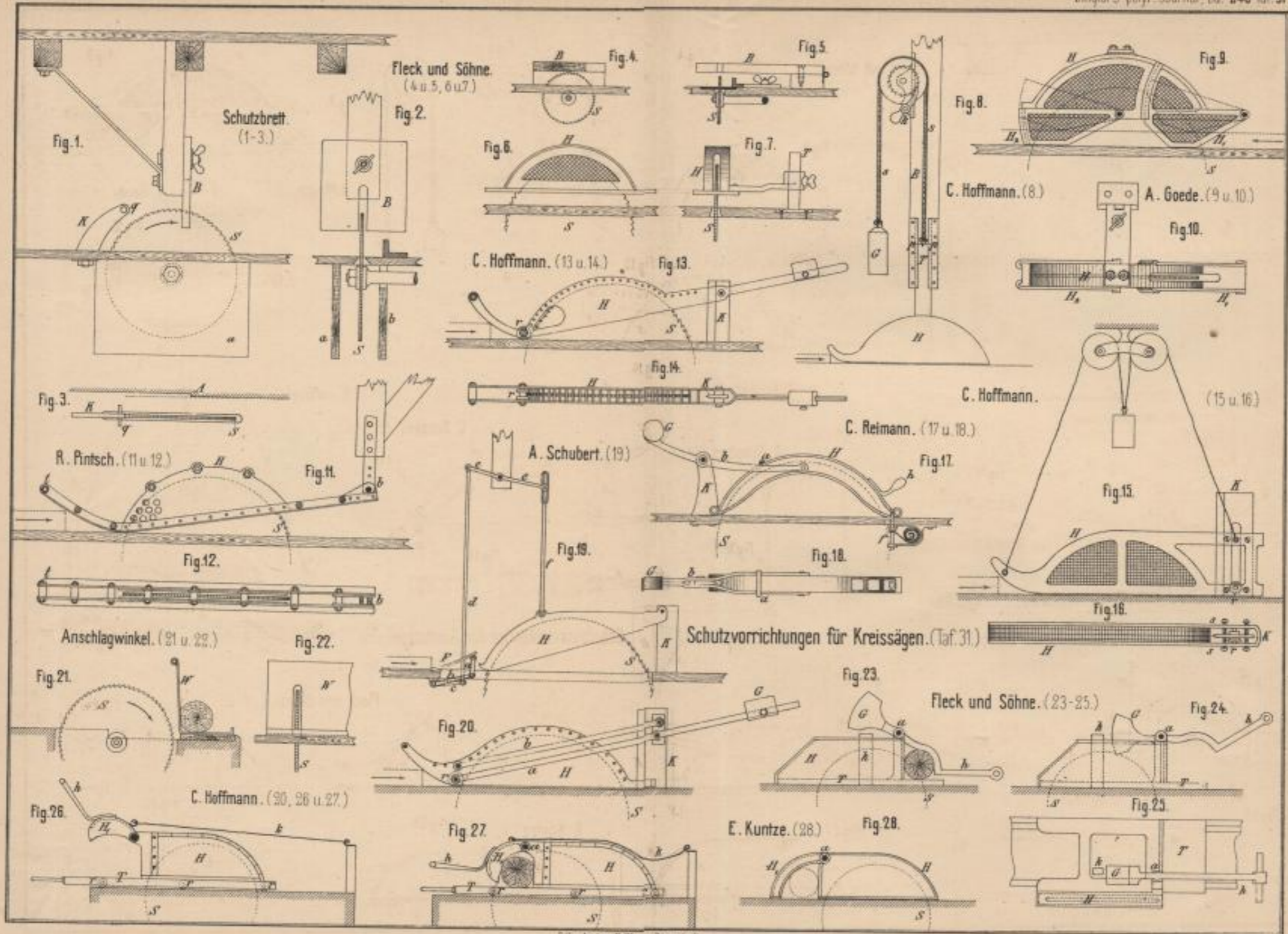

Lith. Anst. v. F. Wiese, Darmstadt.

A. Behne's Hahnsteuerung. (1-8)

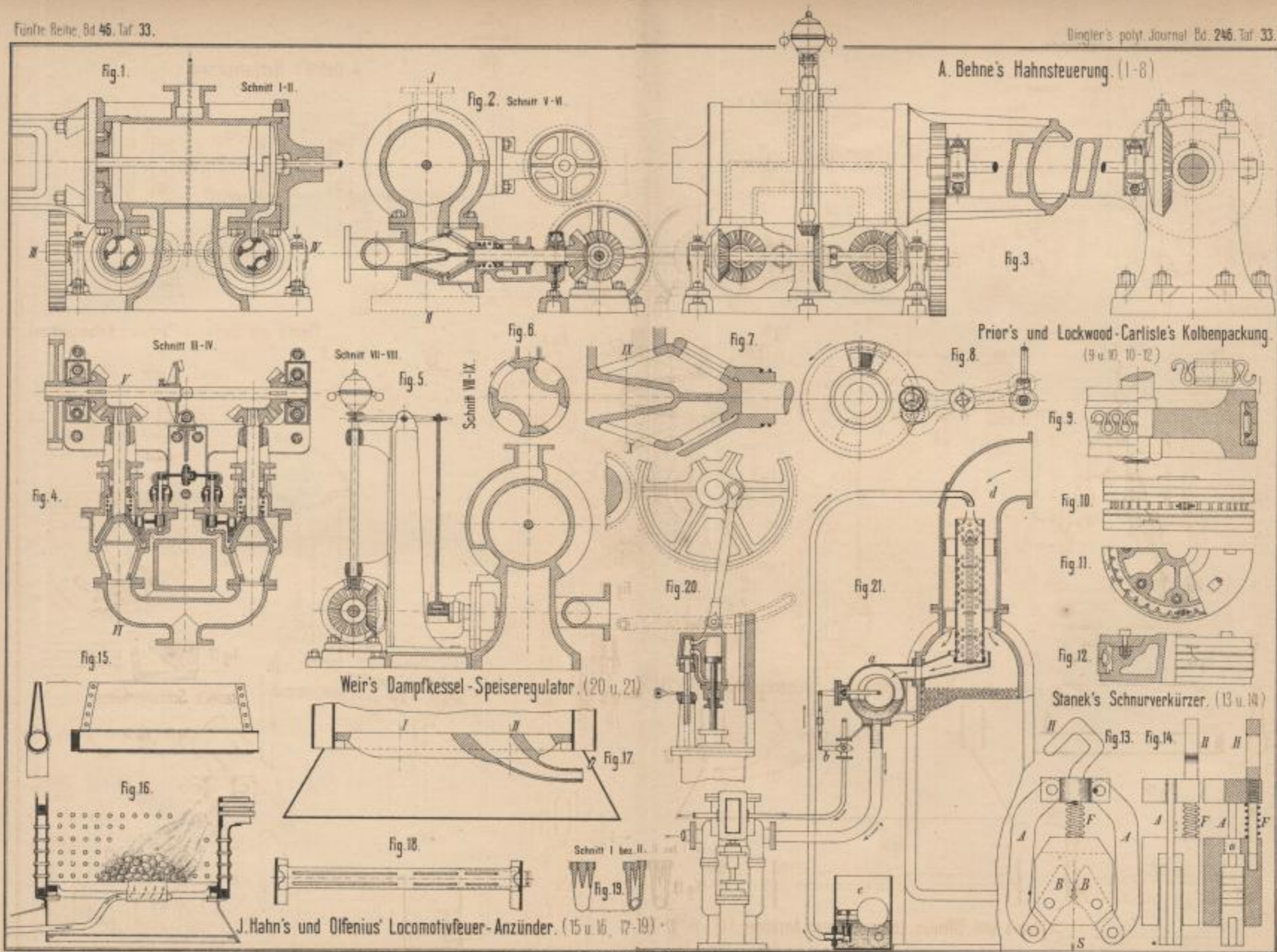

Prior's und Lockwood-Carlisle's Kolbenpackung. (9 u. 10, 11-12)

Weir's Dampfkessel-Speiseregulator. (20 u. 21)

J. Hahn's und Olfenius' Locomotivfeuer-Anzünder. (15 u. 16, 17-19)

Stanek's Schnurverkürzer. (13 u. 14)

Lith. Anst. v. P. Wirtz, Darmstadt

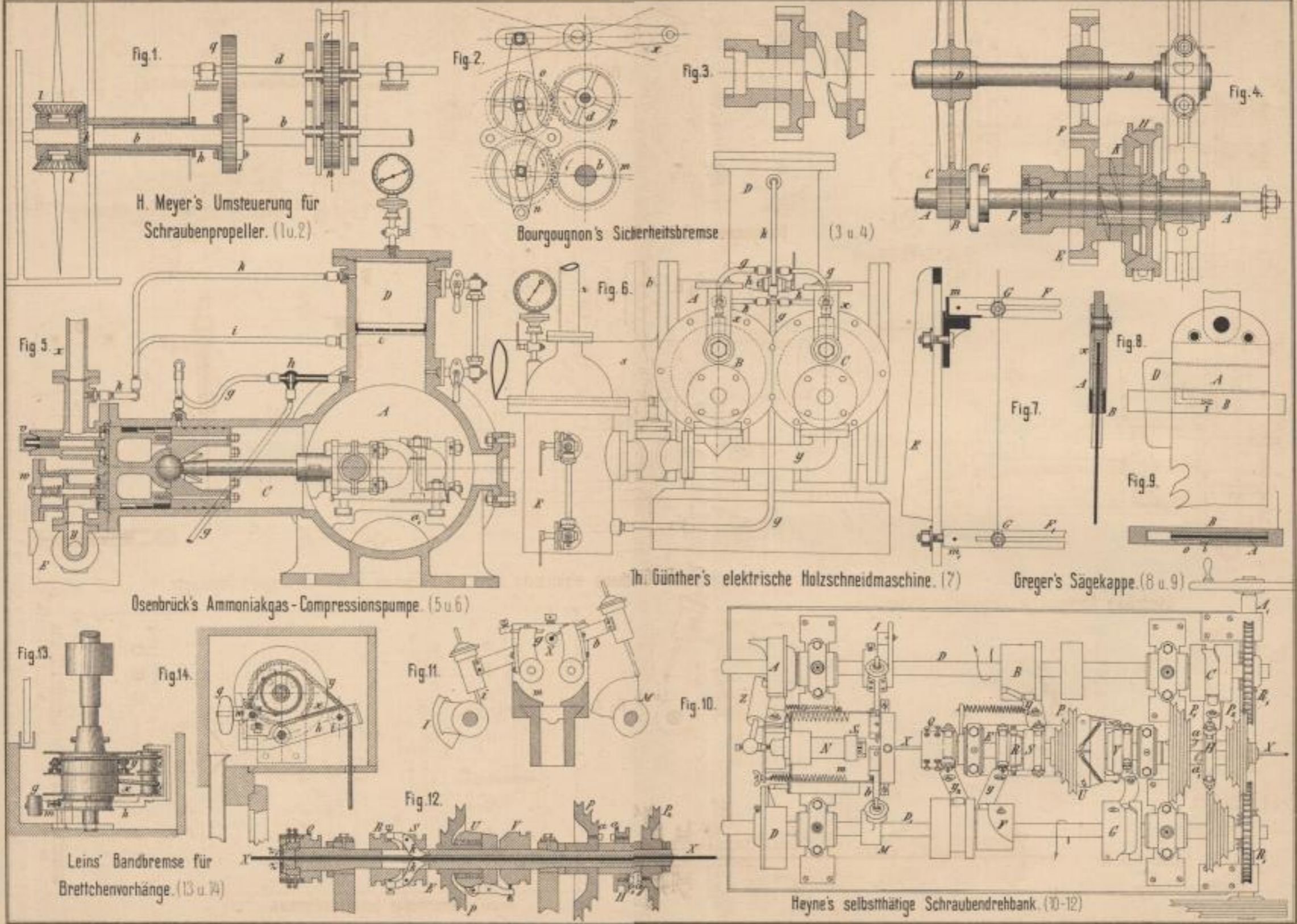

Lith. Anst. v. F. Wirtz, Darmstadt.

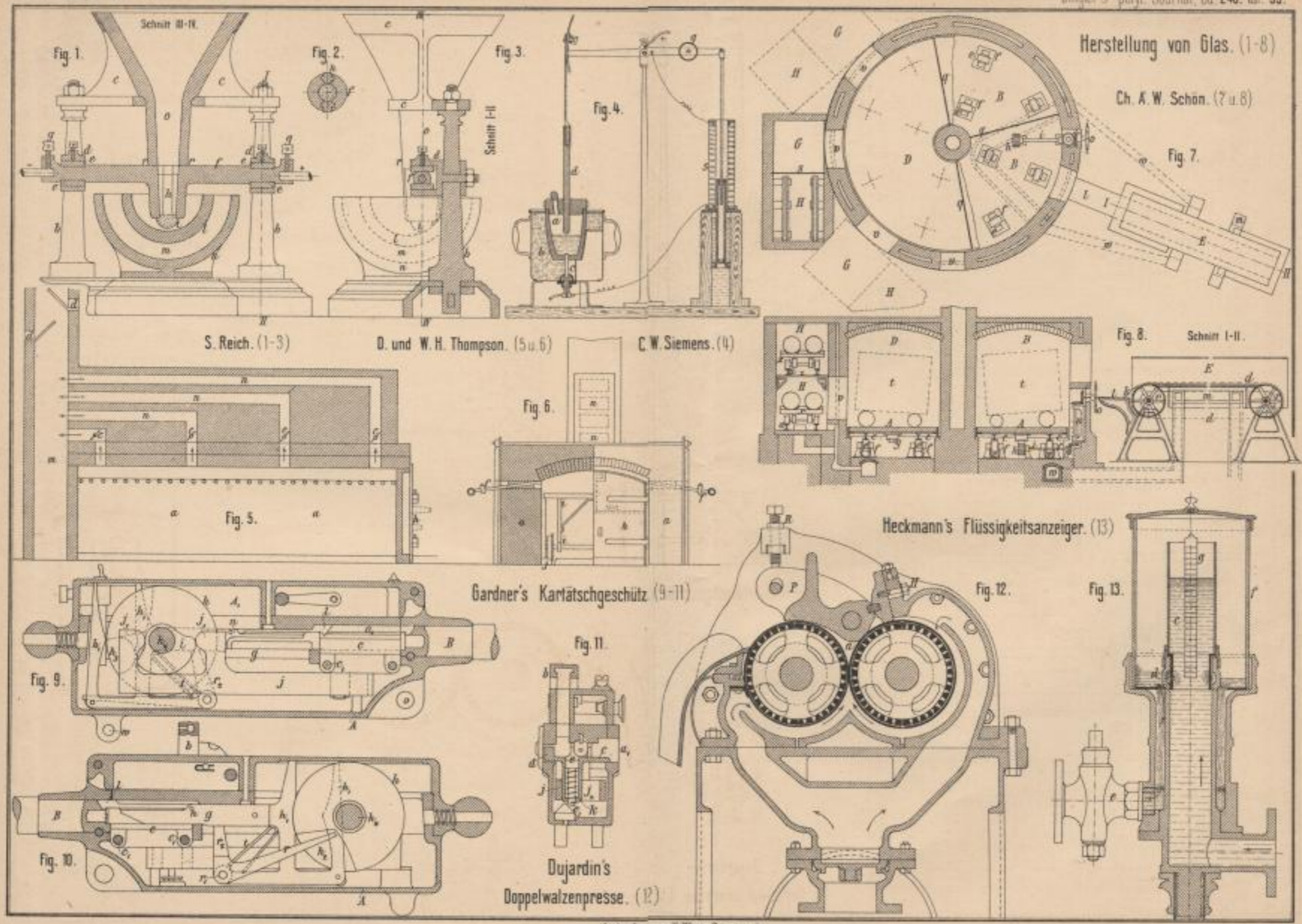

Lith. Anst. v. F. Wenz, Darmstadt.

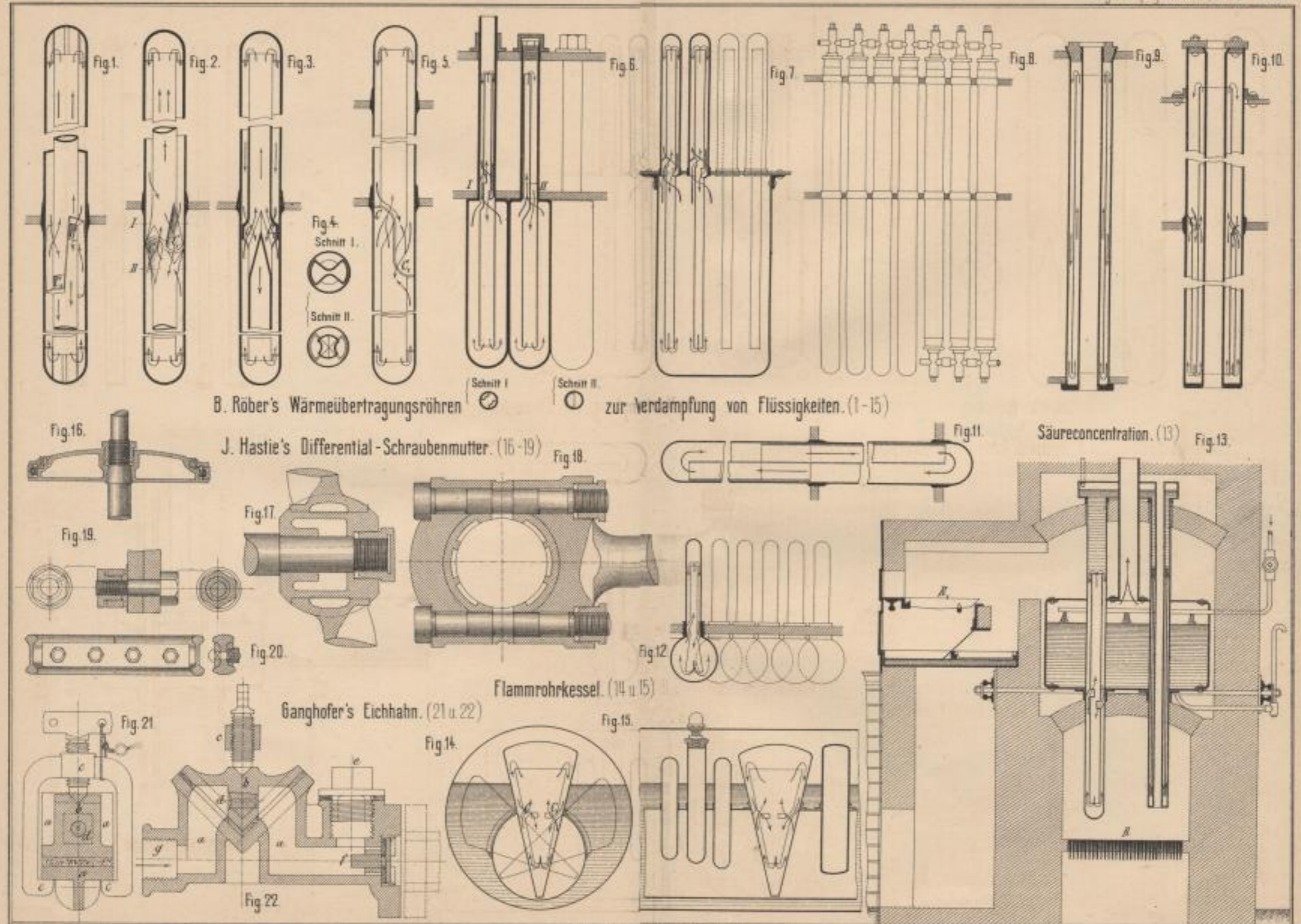

Lith. Anst. v. P. Wern, Darmstadt.

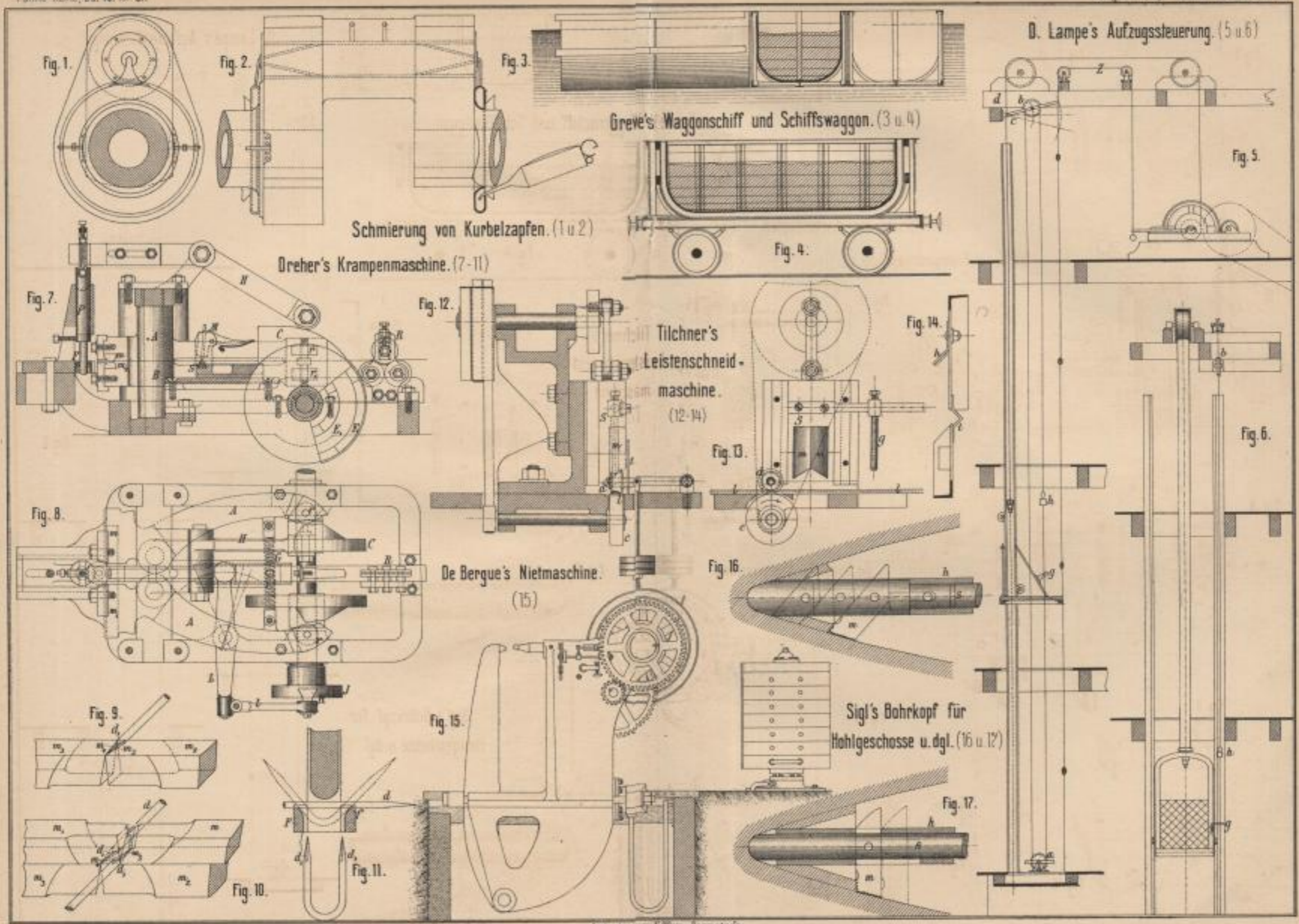

D. Lampe's Aufzugssteuerung. (5 u. 6)

Greve's Waggonschiff und Schiffswaggon. (3 u. 4)

Schmierung von Kurbelzapfen. (1 u. 2)

Dreher's Krampenmaschine. (7-11)

Tilchner's Leistschneidmaschine. (12-14)

De Bergue's Nietmaschine. (15)

Sigl's Bohrkopf für Hohlgeschosse u. dgl. (16 u. 17)

Ich. Anst. v. F. Witz, Darmstadt.

J. Gjers' Durchweichungs- oder Wärmeföfen für Flußeisenblöcke. (1-5)

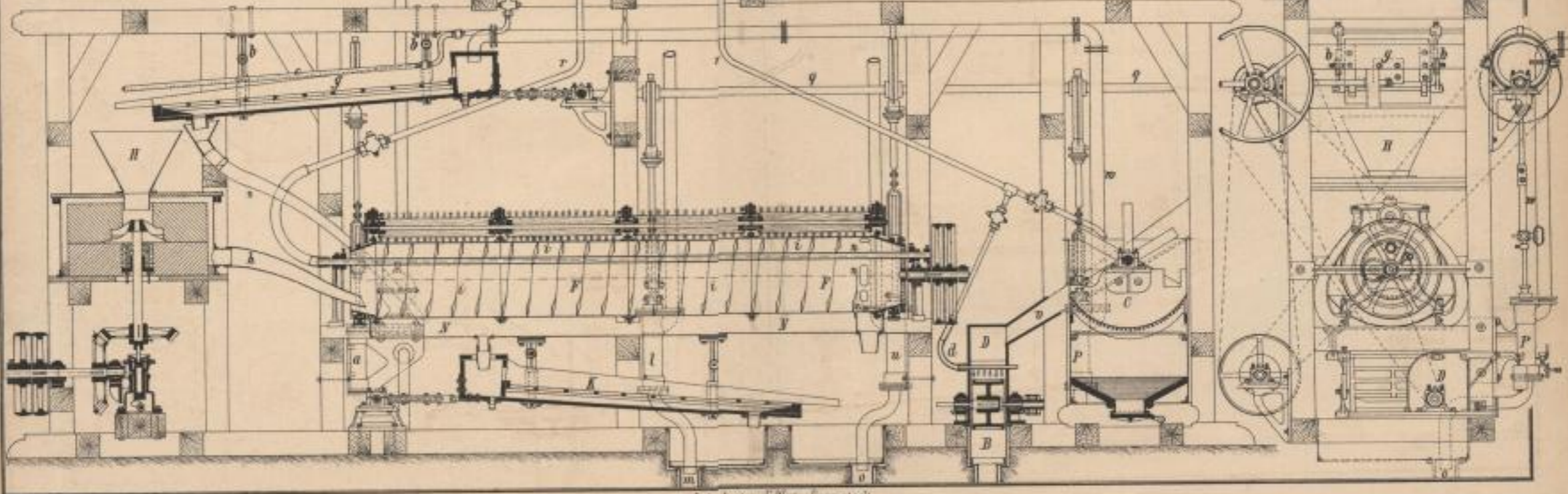
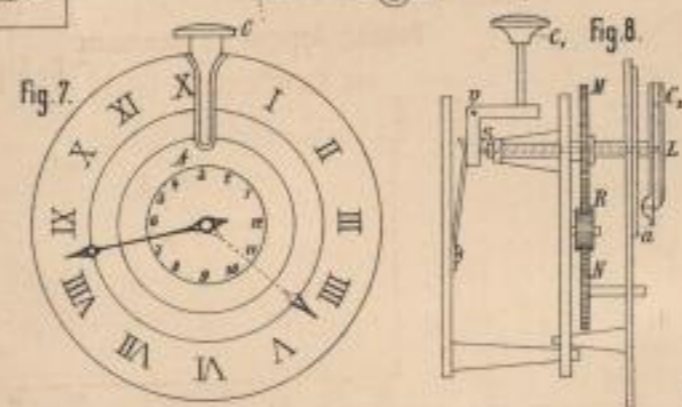
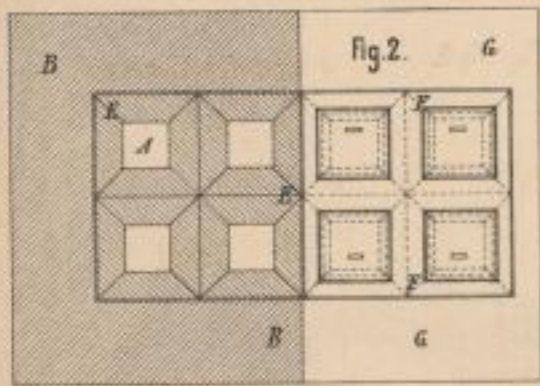
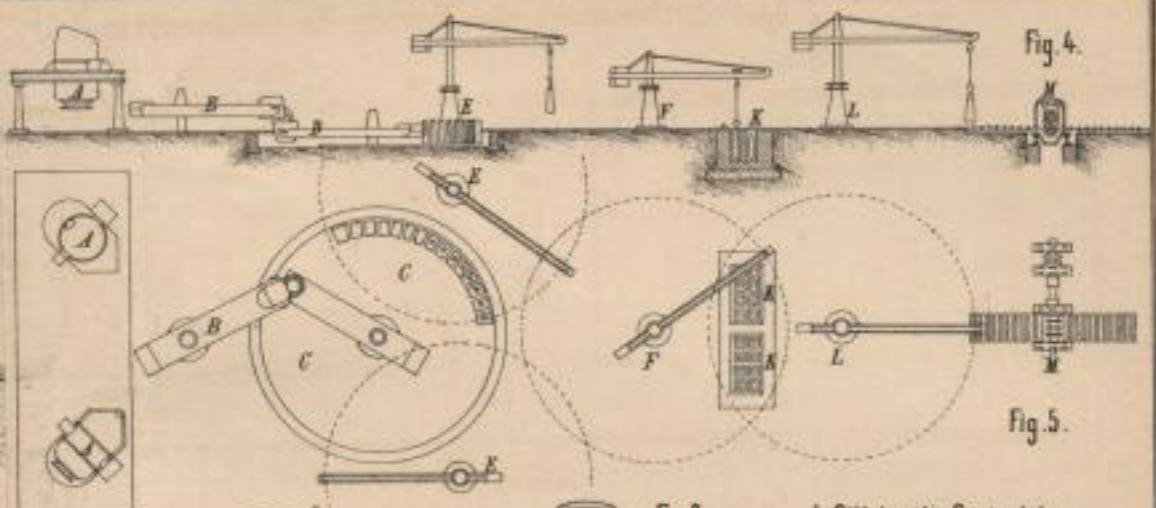
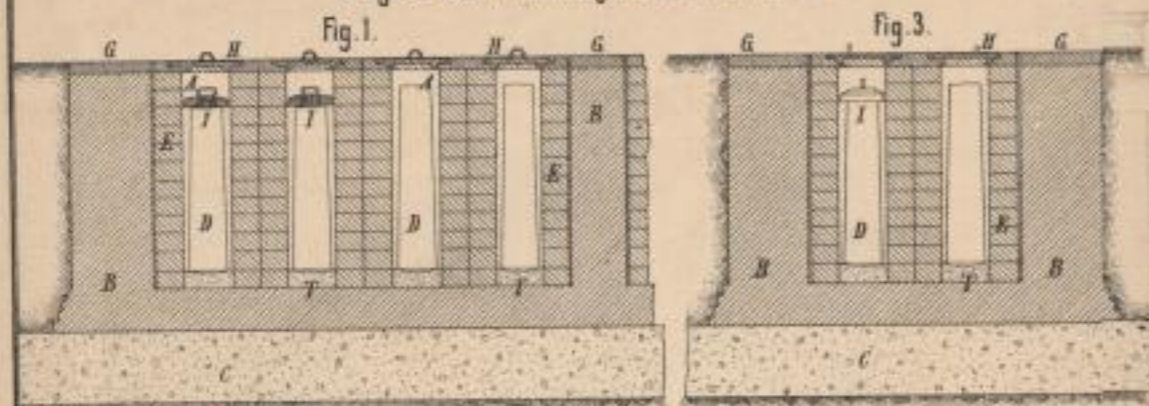

Lith. Anst. v. F. Wirtz, Darmstadt.

W. R. Eckart's Chronograph mit Hipp'schen Echappement für technische Zwecke (1 u. 2.)

Spellier's elektrische Uhr. (3)

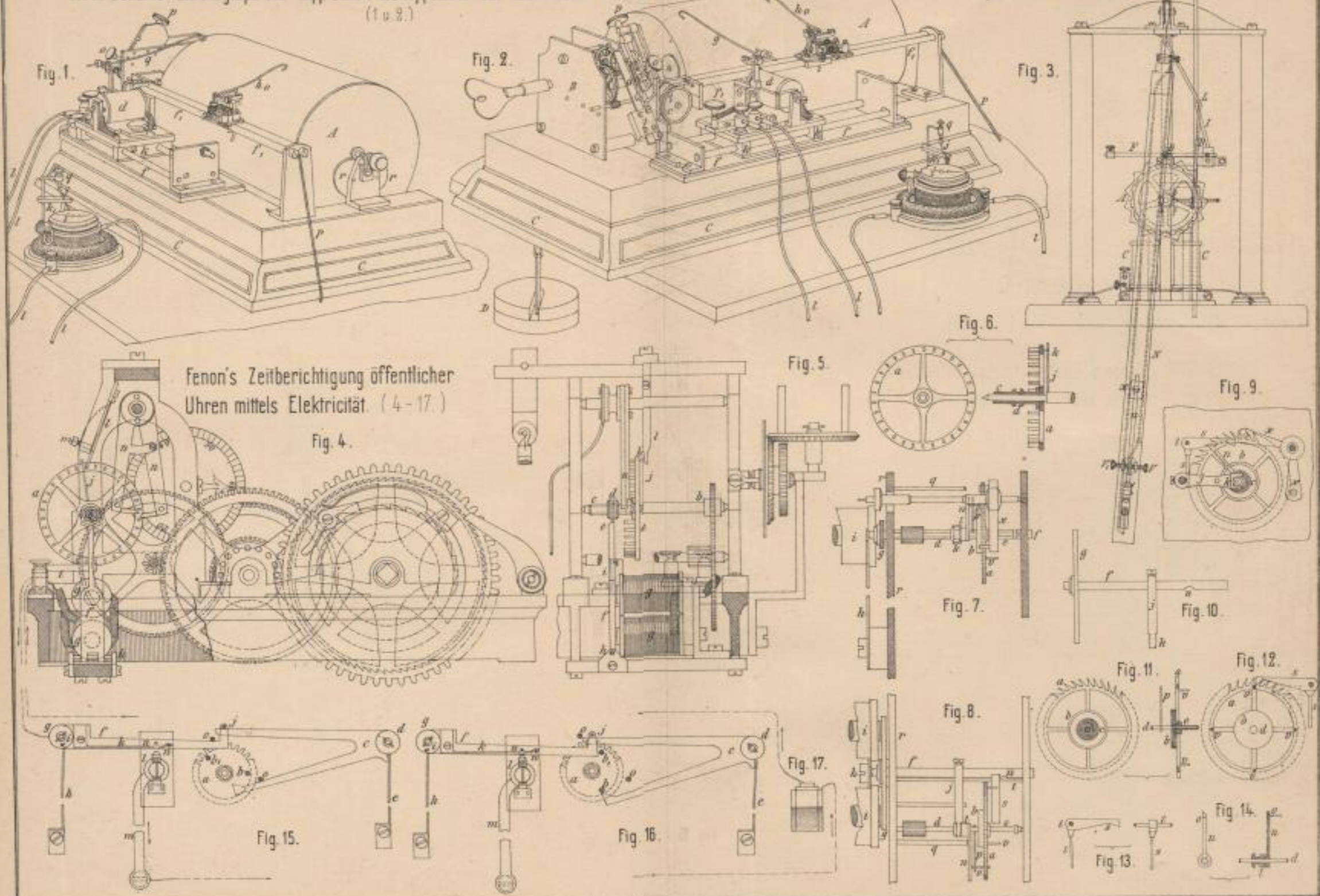

186. Anst. v. F. Wirtz, Darmstadt.

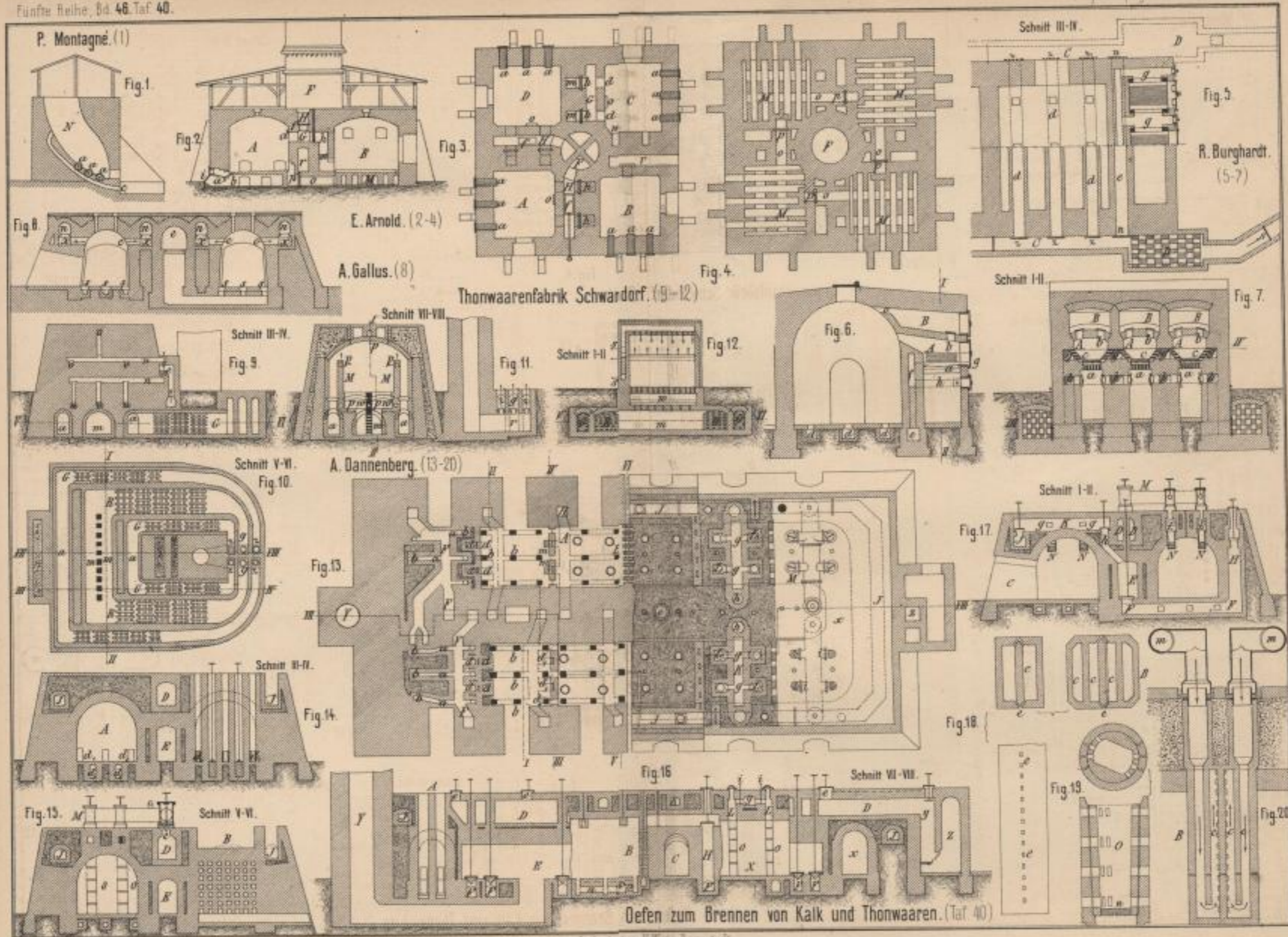

Oefen zum Brennen von Kalk und Thonwaren. (Taf. 40)

Lehr. Aut. v. P. Wirtz, Darmstadt.

Kainzelmaier
Buchbinder
DRF SOF

Technol. A 264

SLUB DRESDEN



3 2422832