

Blank rectangular label on a yellowish, speckled book cover.

A t l a s

zu

Dingler's polytechnischem Journal.

Band 243.

(Dreiundsechzigster Jahrgang.)

Jahrgang 1882.

Enthaltend 38 lithographirte Tafeln.



Augsburg.

Druck und Verlag der J. G. COTTA'schen Buchhandlung.

42520

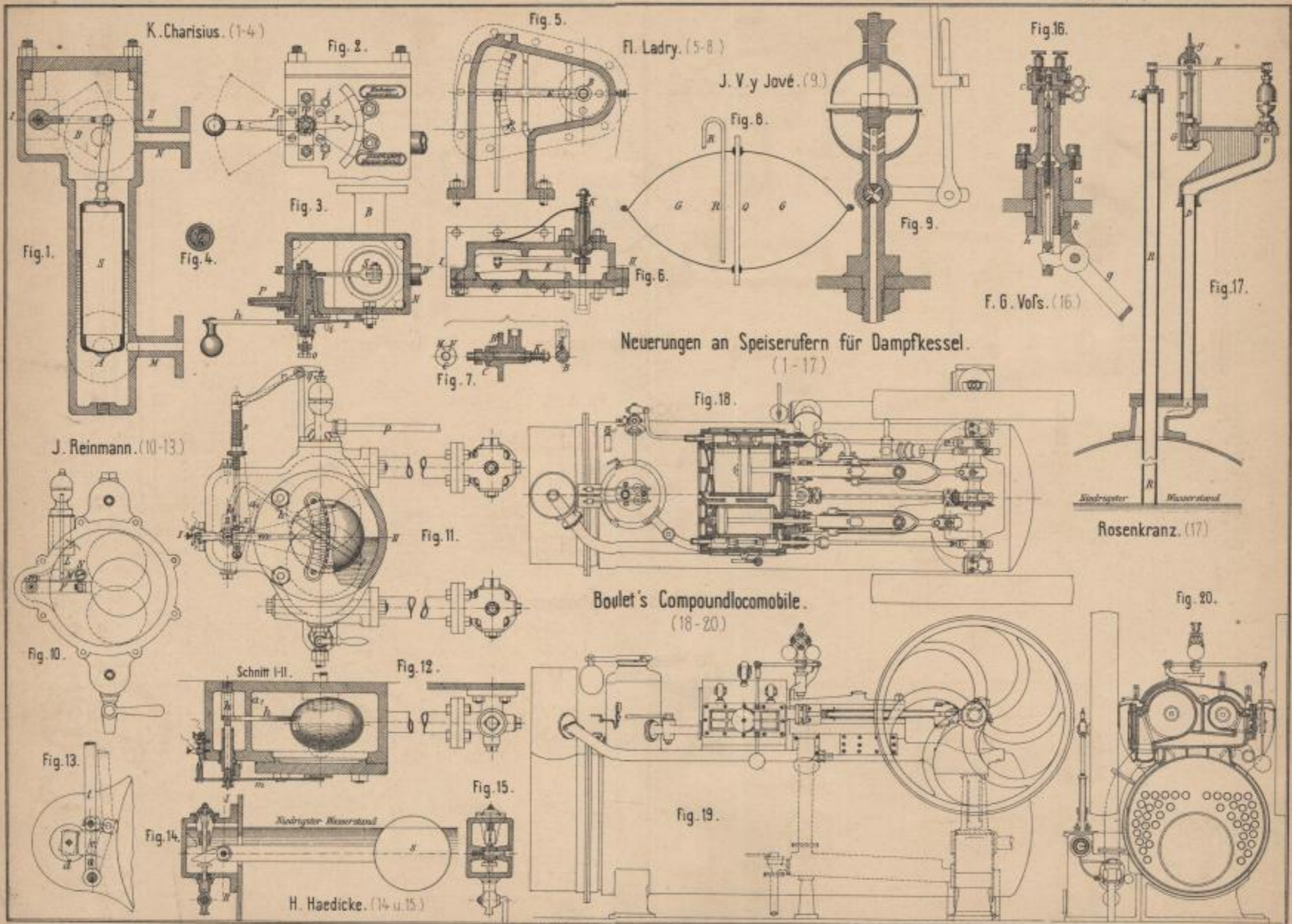

Neuerungen an Speiserufen für Dampfkessel. (1-17)

Boulet's Compoundlocomobile. (18-20)

Rosenkranz. (17)

H. Haedicke. (14 u. 15)

Lith. Anst. v. P. W. v. Dornstadt.

Latowski's Sicherheitsventil für Dampfzylinder (1-6)

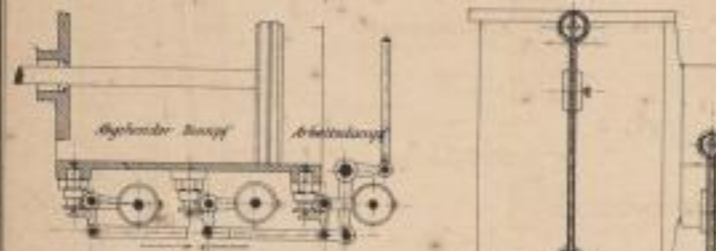
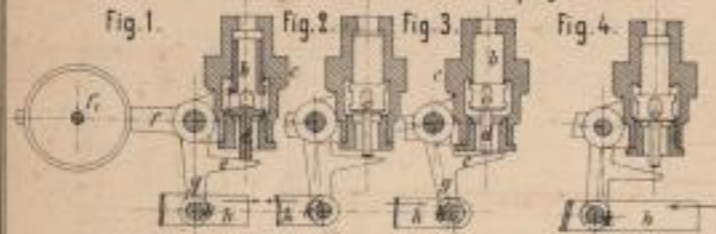

Kröber's Wassersäulenpumpe (16 u. 17)

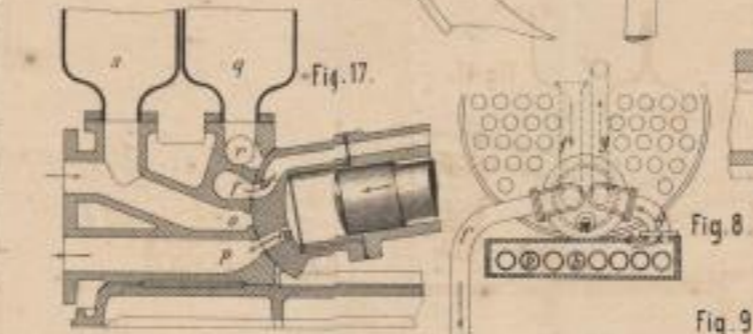
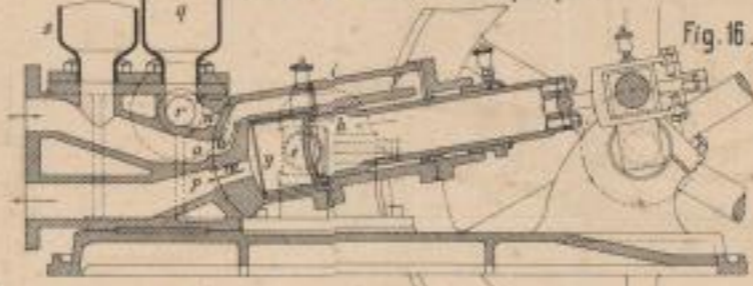

Nacke's Bodenschutz für Dampfkessel (7-15)

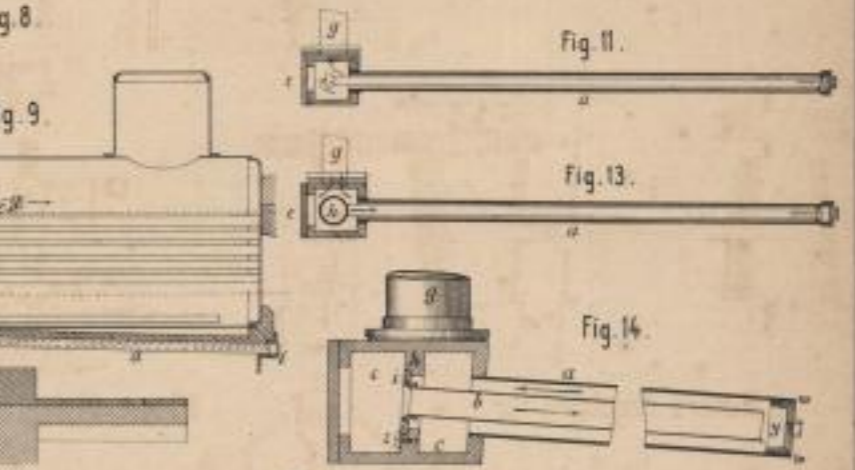
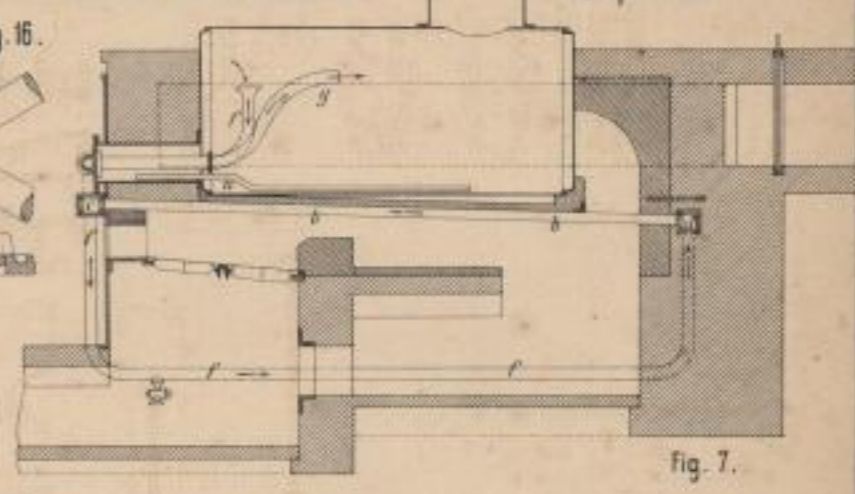

L. Müller's Regulator für Wasserräder (18-23)

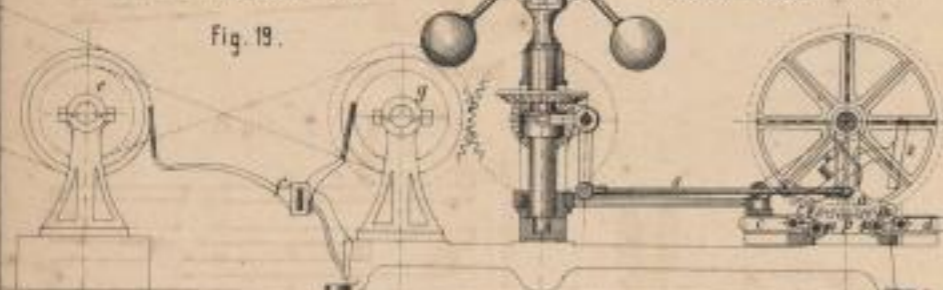

Neuerungen an Sicherheitskurbeln (24-26)

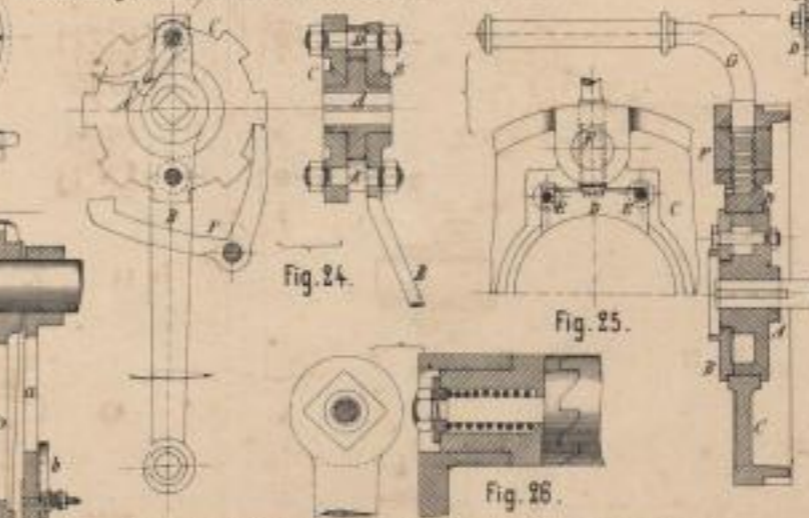

Maschinenfabrik Rhein und Lahn (Gauhe, Gockel und Co.) (24)

R. Böncher (25)

E. Mehl (26)

Lith. Anst. v. F. W. Barts, Darmstadt

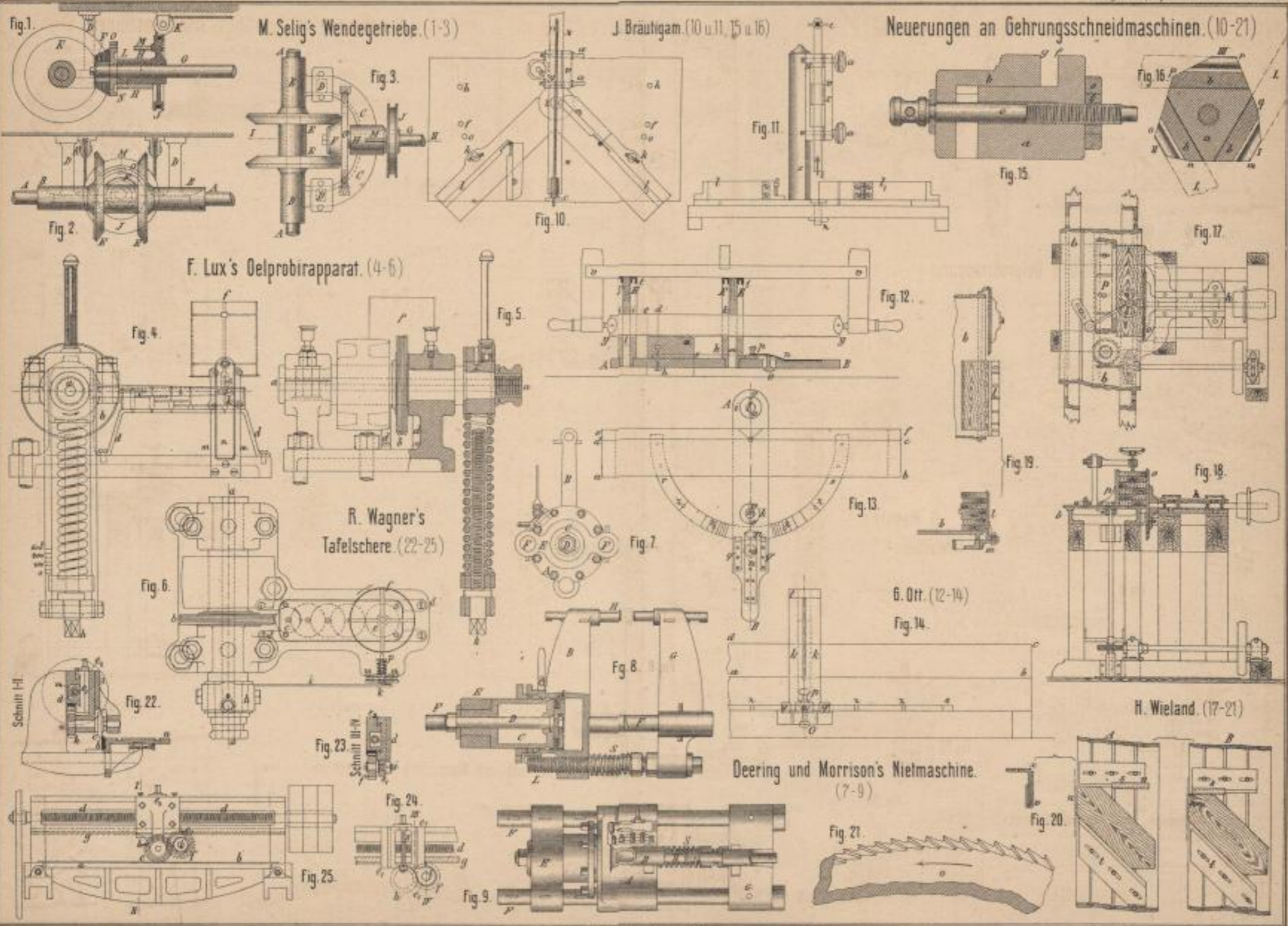

M. Selig's Wendegetriebe. (1-3)

J. Bräutigam. (10 u. 11, 15 u. 16)

Neuerungen an Gehrungsschneidmaschinen. (10-21)

F. Lux's Oelprobrapparat. (4-6)

R. Wagner's Tafelschere. (22-25)

Deering und Morrison's Nietenmaschine. (7-9)

H. Wieland. (17-21)

Lehrbuch v. F. W. Dornmüller



Längsschneider. (1 u. 2, 3-5)

Neuerungen an Papierschneidmaschinen. (Taf. 4)

Querschneider. (7-9, 10 u. 11, 12, 13 u. 14)

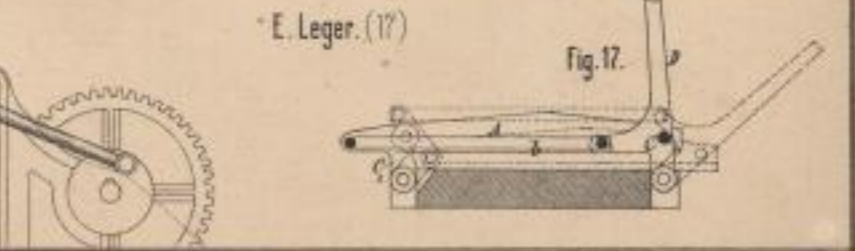
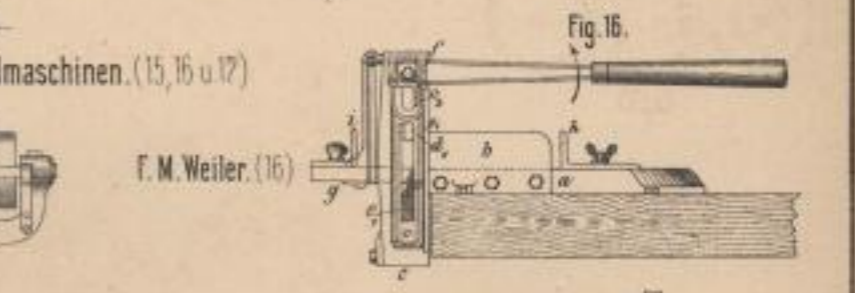
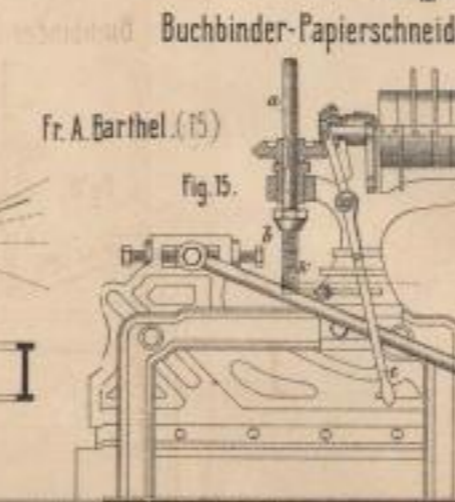
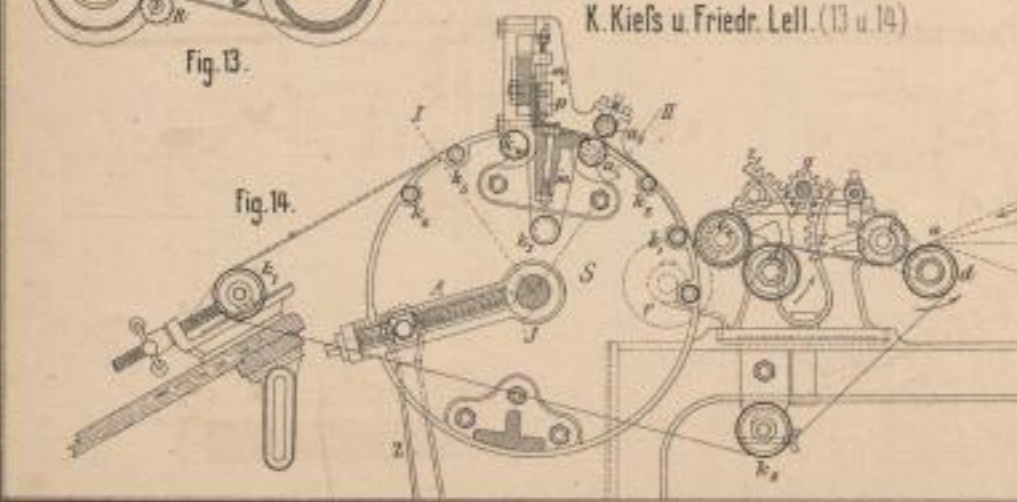
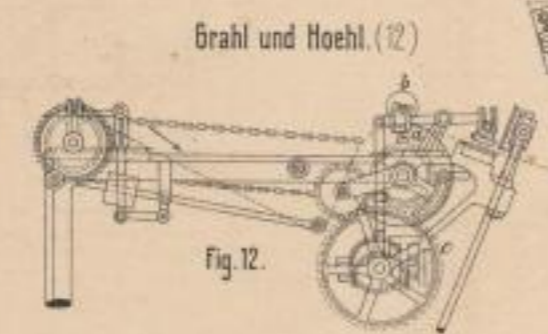
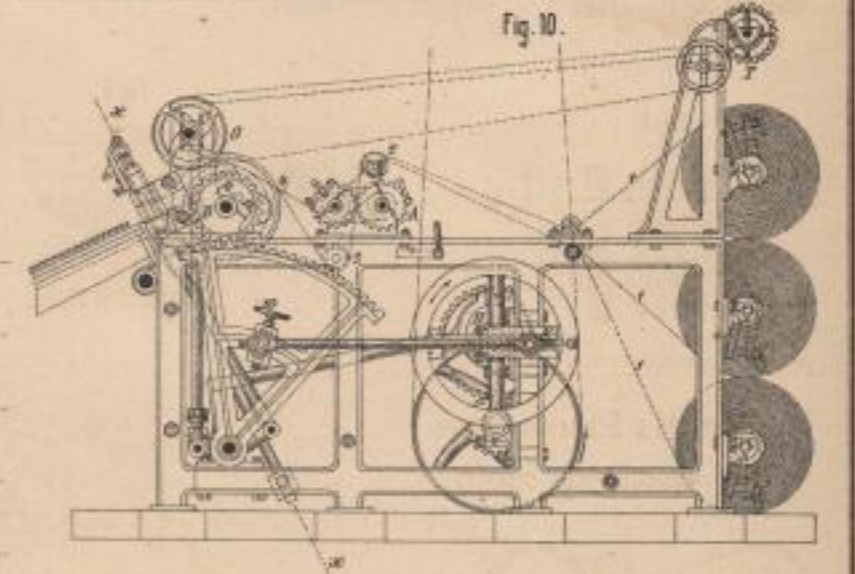
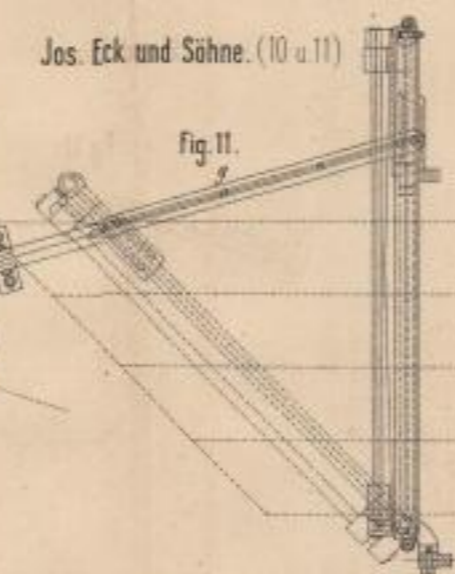
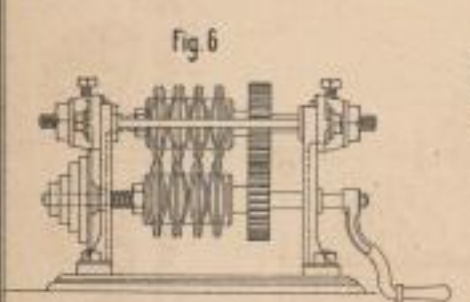
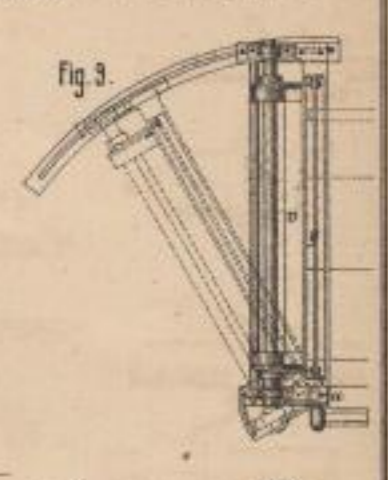
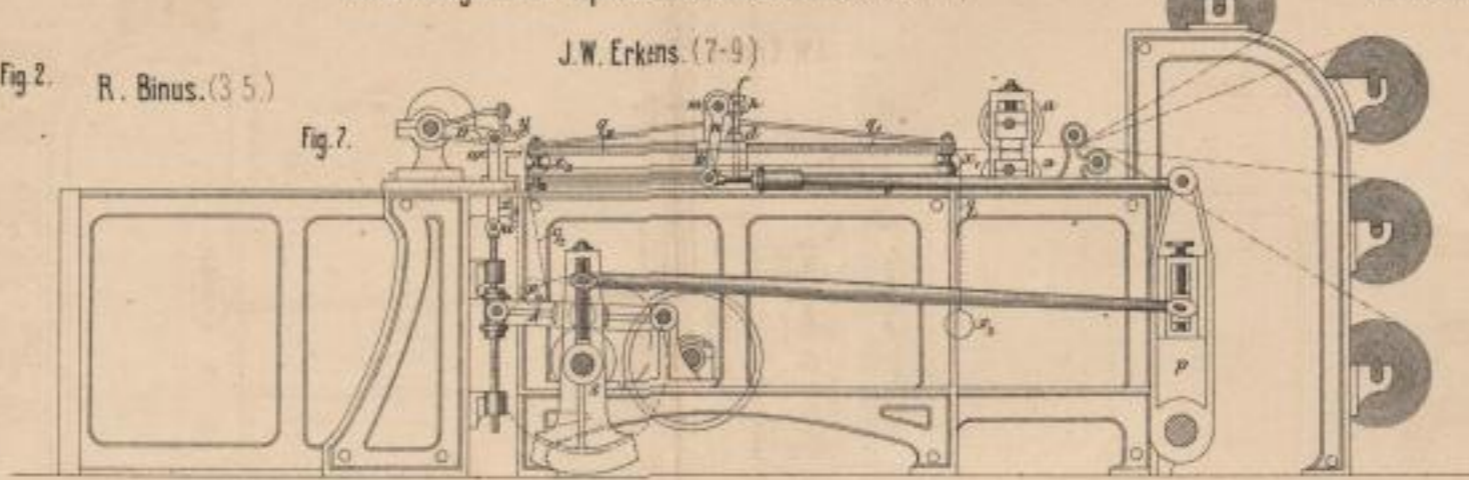
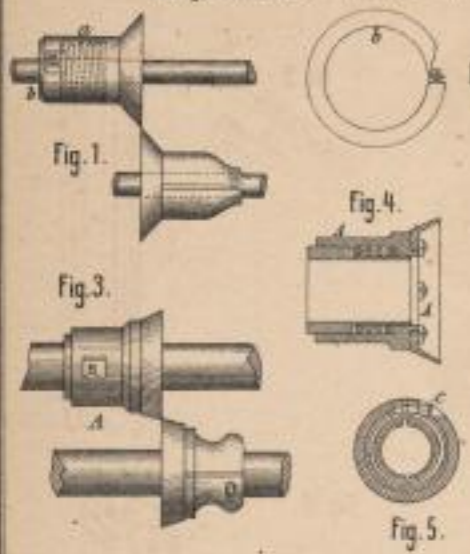

Lehr. Anst. v. F. Weier, Darmstadt.

Ehrhardt's Oelpresse. (5-7)

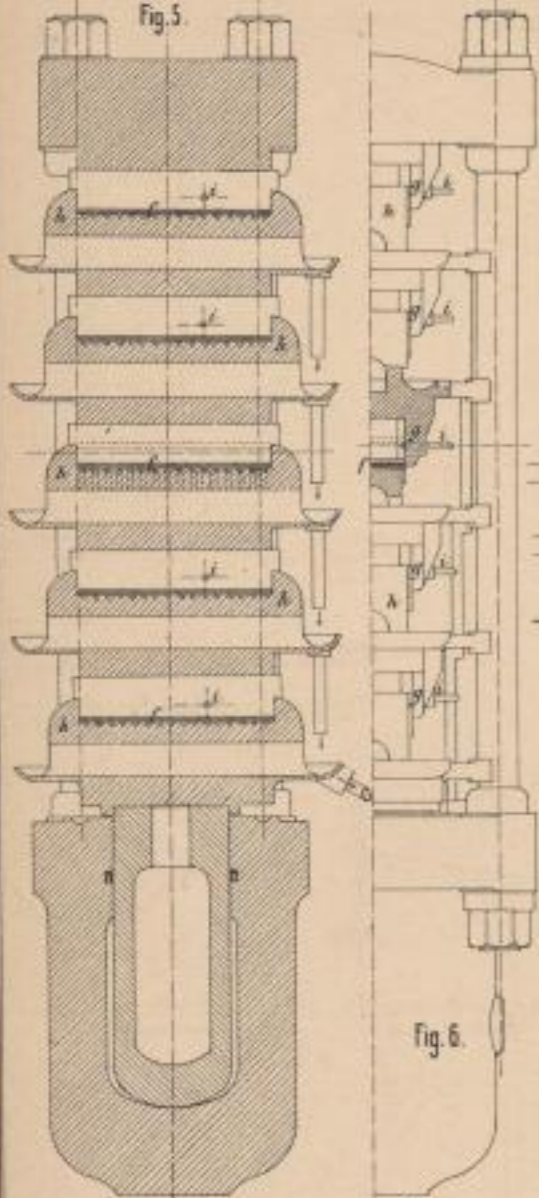

Fig. 5

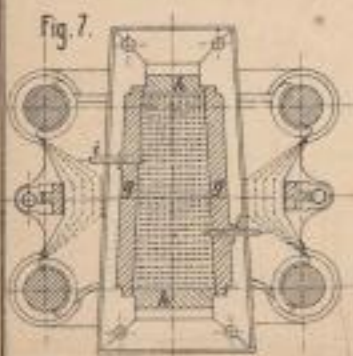

Fig. 7

R. Schwarzkopff's Dampf-
kesselapparat (6)

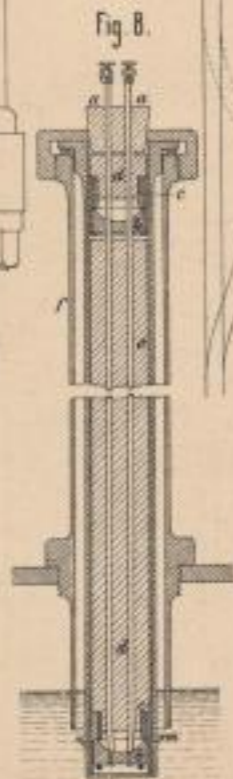

Fig. 8

Pohlmann und Niesenhaus'
Fangvorrichtung (1-4)

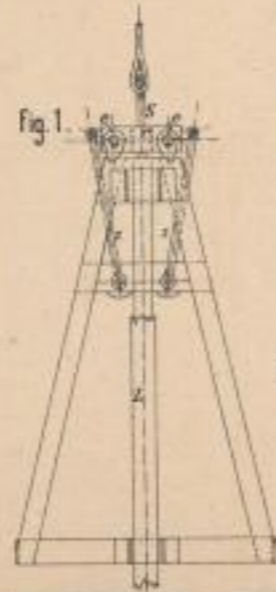

Fig. 1

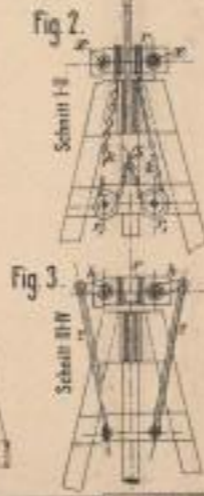

Fig. 2



Fig. 3

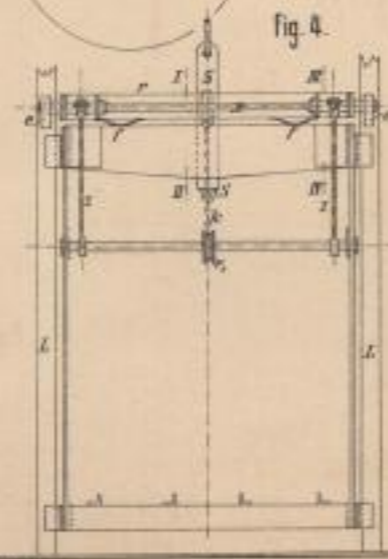

Fig. 4

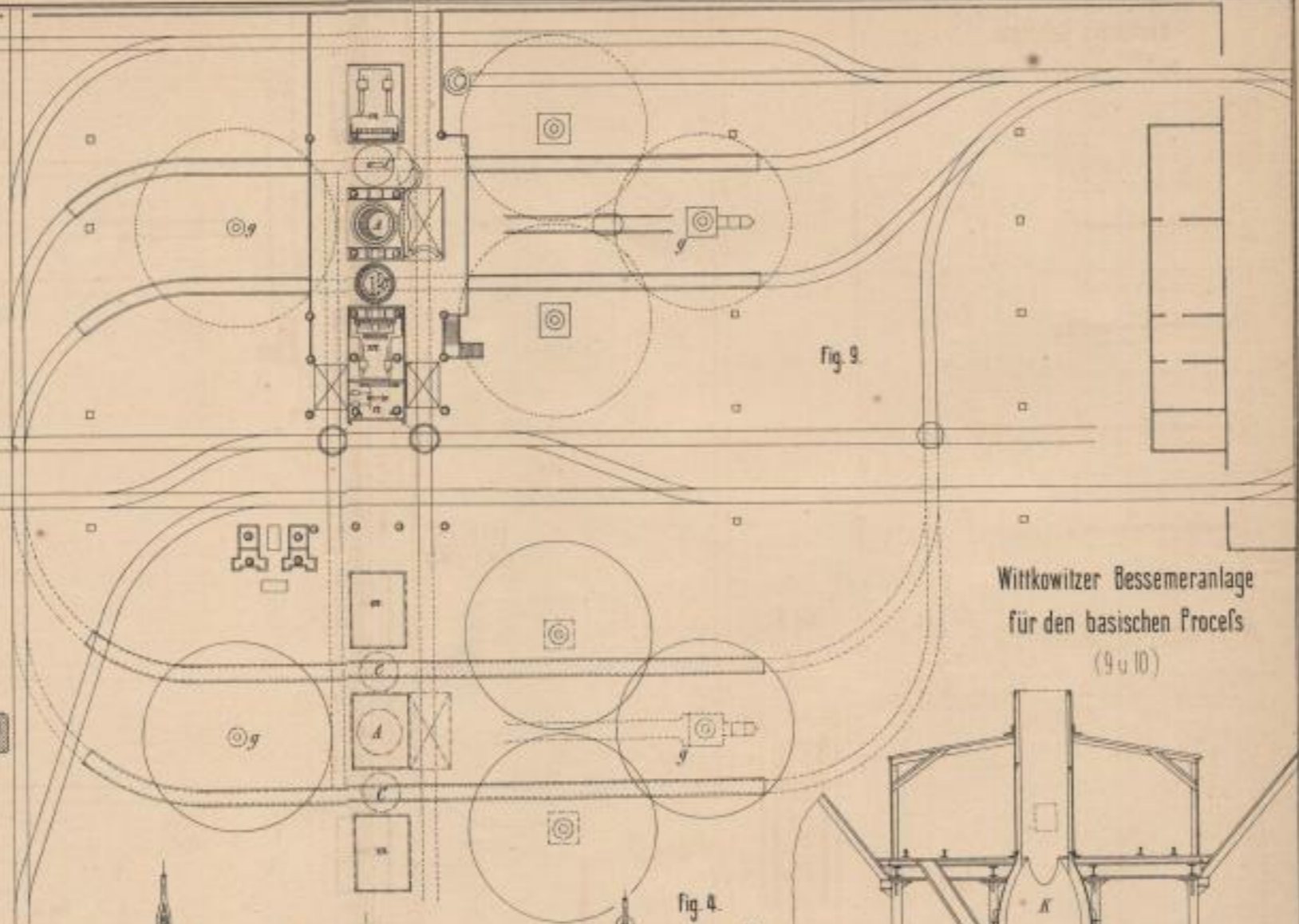

Fig. 9

Wittkowitz's Bessemeranlage
für den basischen Proceß
(9 u 10)

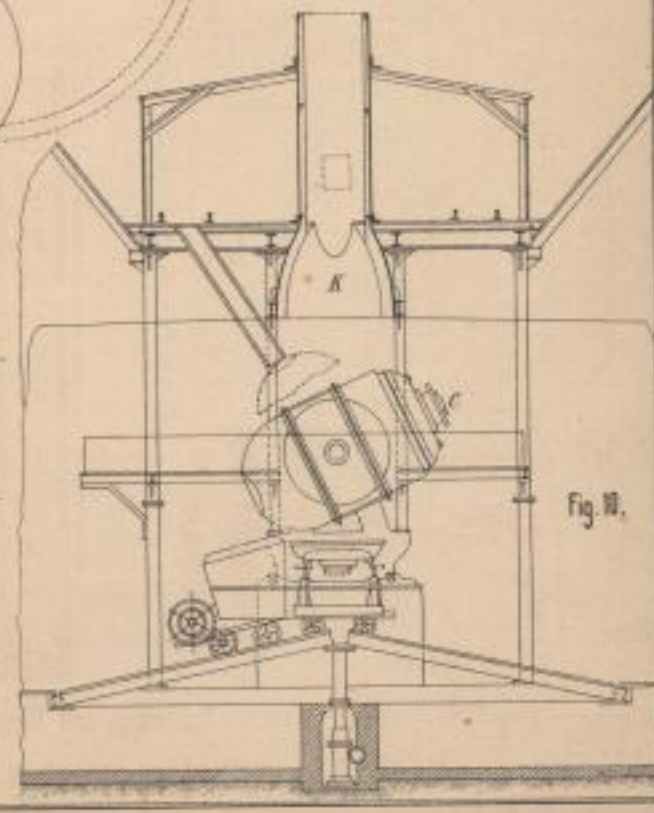
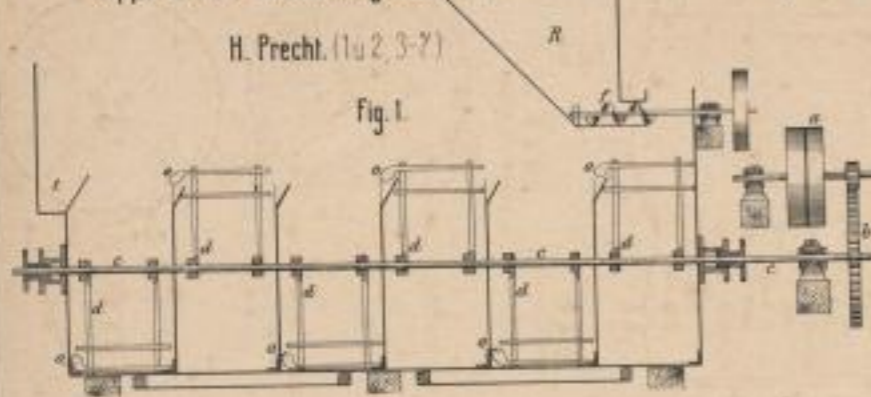

Fig. 10

Leit. Arch. v. J. Wirtz, Darmstadt.

Apparat zur Herstellung von Kaliumsulfat. (1u2)



Apparate zur Trennung des Chornatriums u. Chlormagnesiums von Kaliummagnesiumsulfat. (3-7)

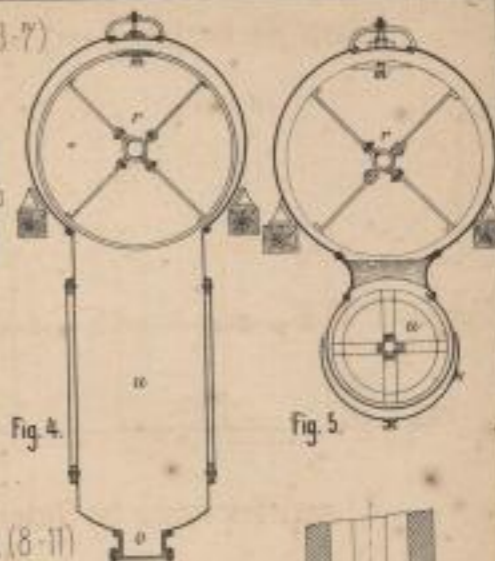
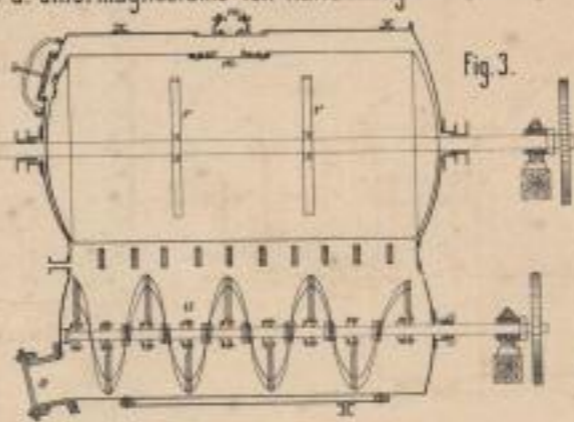

G. Lunge's Bestimmung des Stickoxyduls u. Verhalten des Stickoxydes. (10-17)

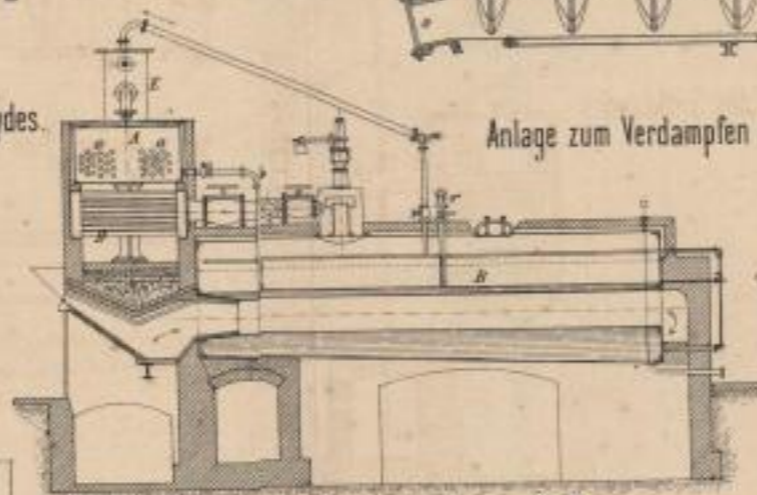
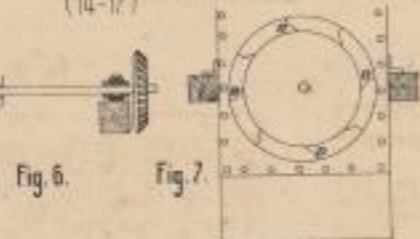

Anlage zum Verdampfen der Mutterlaugen. (8-11)

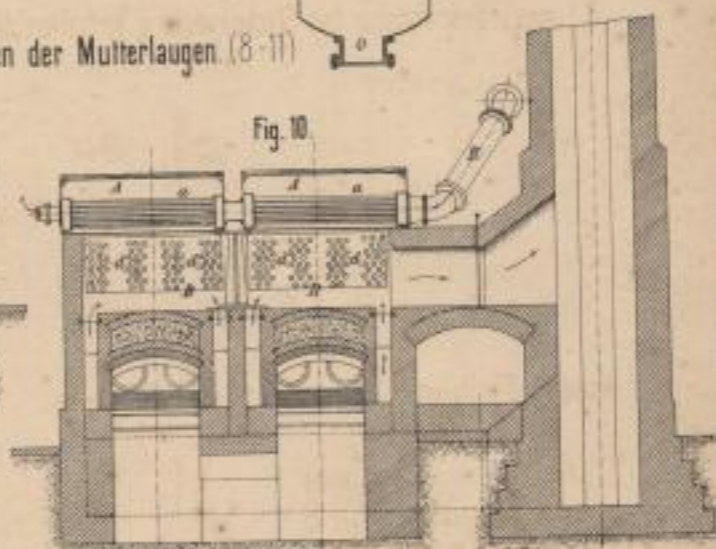

Mason's Pyritofen. (12)

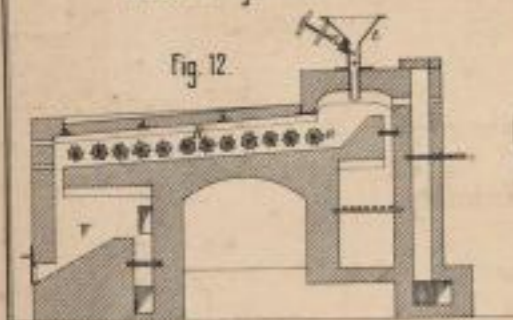

Th. Richters' Mischapparat. (13)

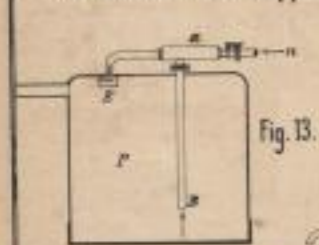

Herstellung von Schwefelsäure. (12-17)

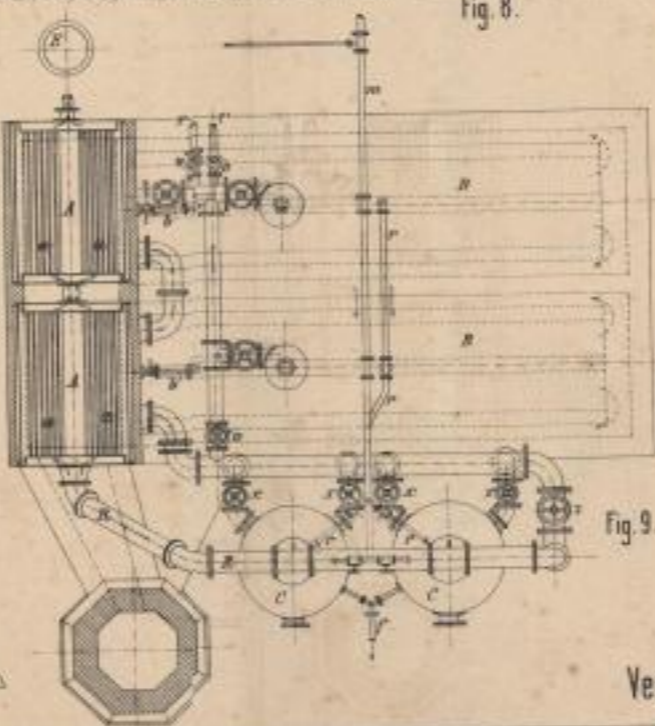

L. Wüstenhagen. (8-11)

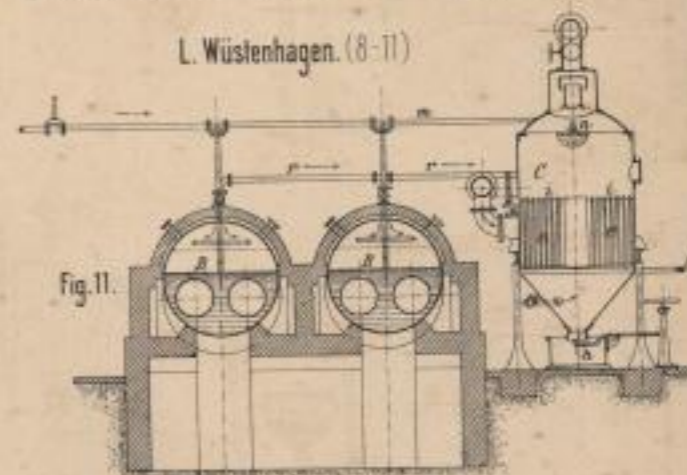

Verarbeitung der Stassfurter Kalisalze. (7-11)

Tab. Anst. v. F. Wiese Darmstadt

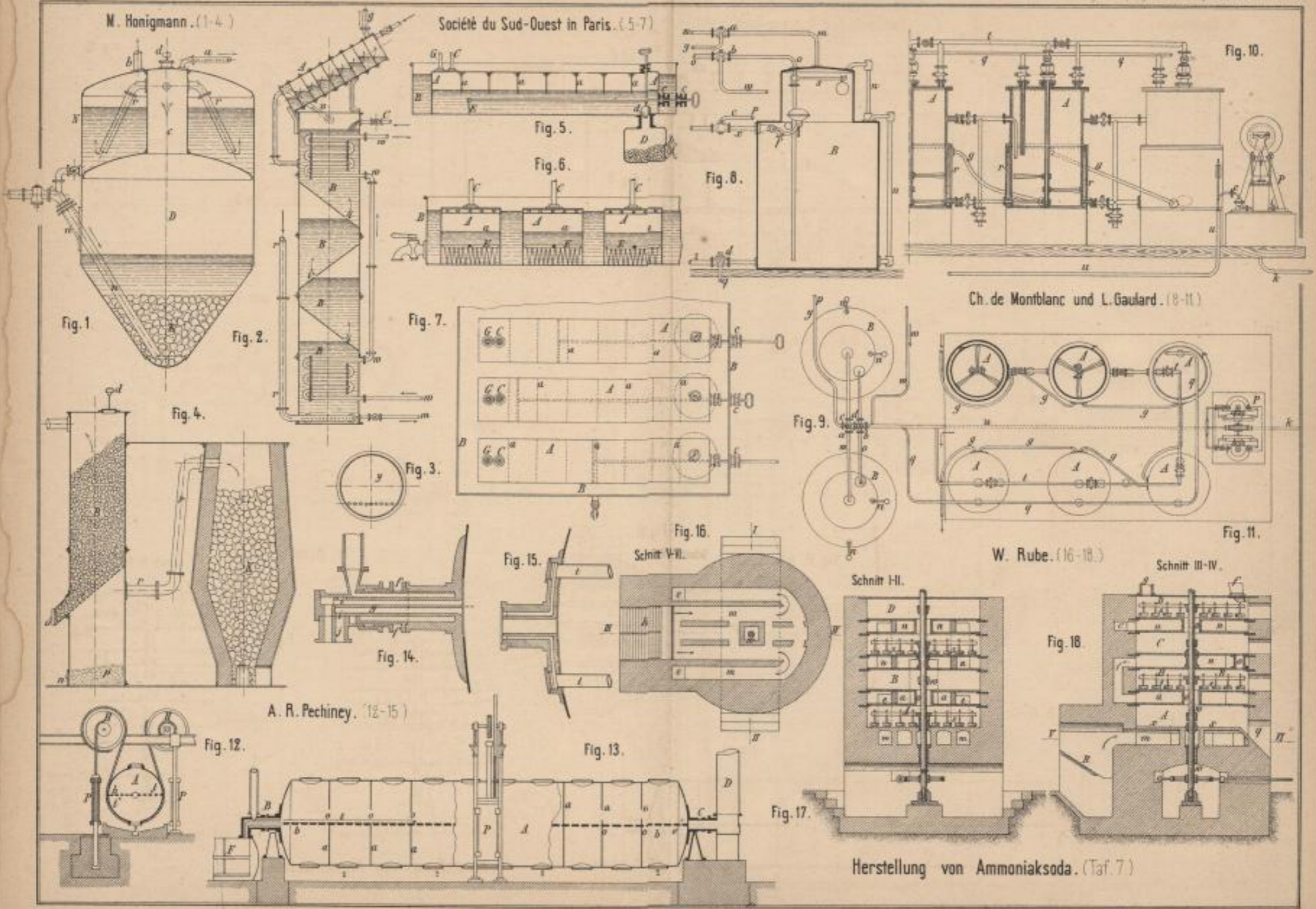

Herstellung von Ammoniak soda. (Taf. 7)

Lith. Anstalt v. W. Neumann



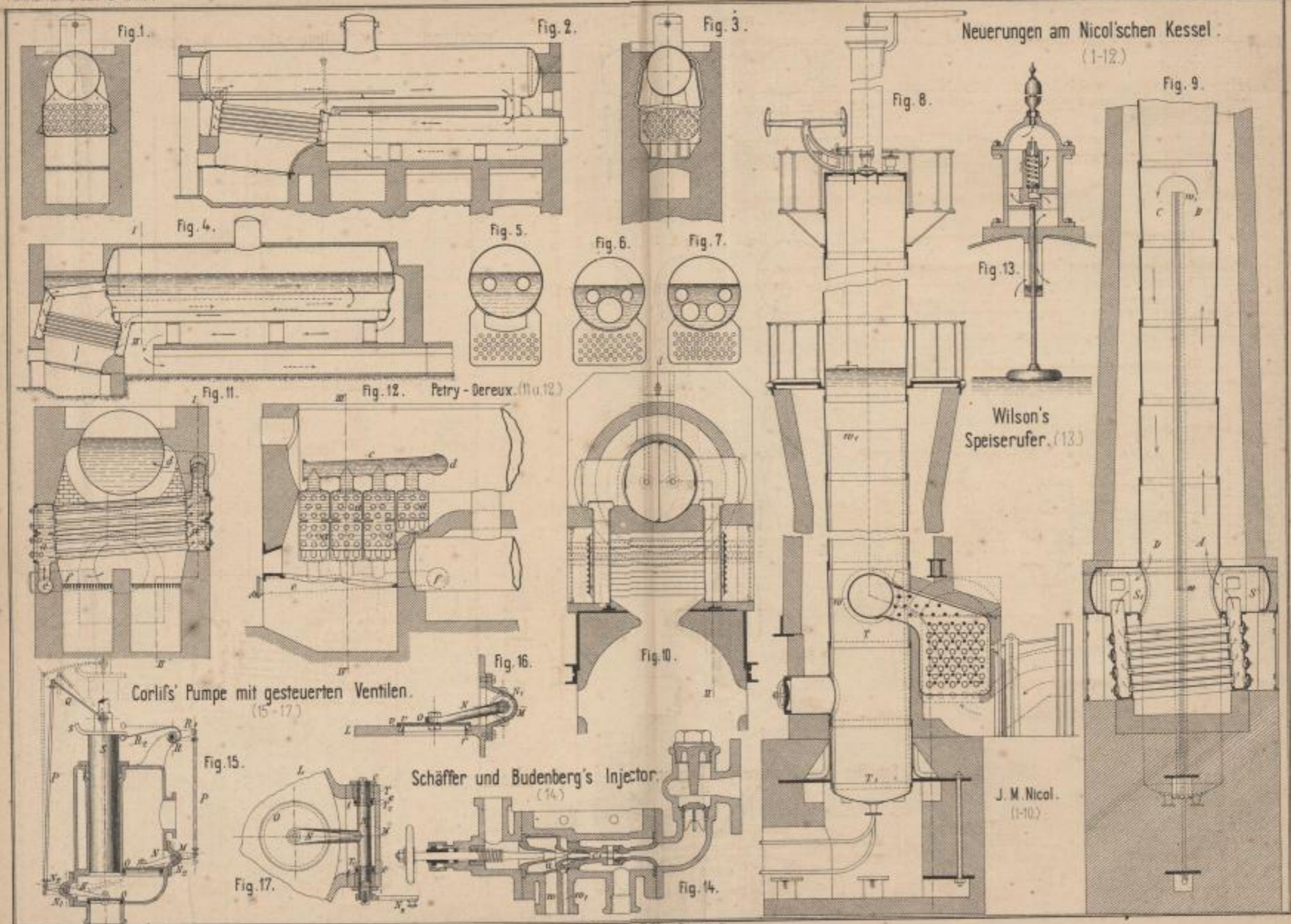

Neuerungen am Nicol'schen Kessel. (1-12.)

Wilson's Speiserufer. (13.)

Corlifs' Pumpe mit gesteuerten Ventilen. (15-17)

Schäffer und Budenberg's Injector. (14.)

J. M. Nicol. (1-10.)

17th. 2nd. 1. F. W. J. J. J. J. J.



Kaltwasser, Wegein und Hübner's Aufzug (8-11)

Indicator von Schäffer u. Budenberg. (1)

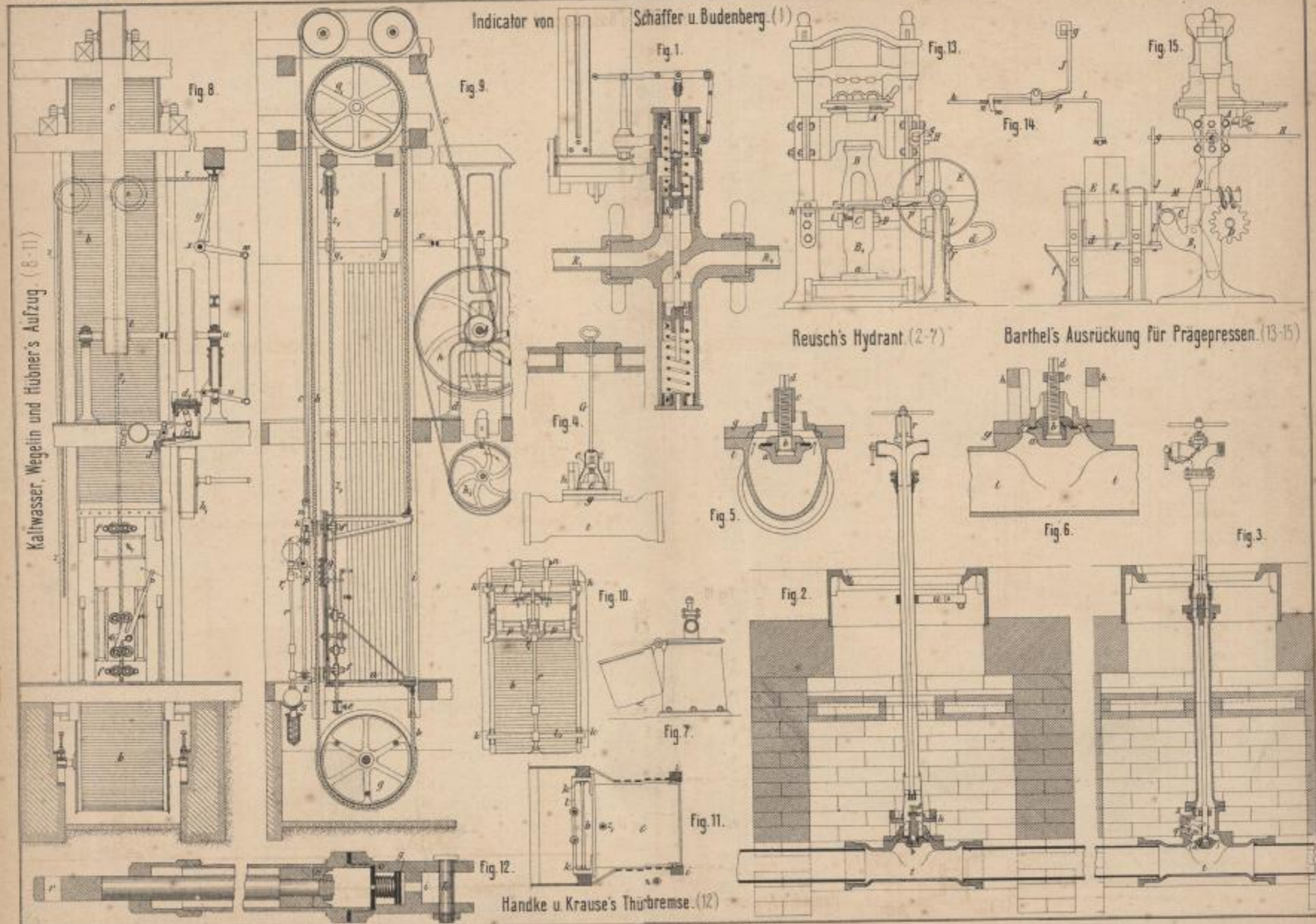

Handke u Krause's Thürbremse. (12)

125f. Anst. v. F. Wirtz, Darmstadt.

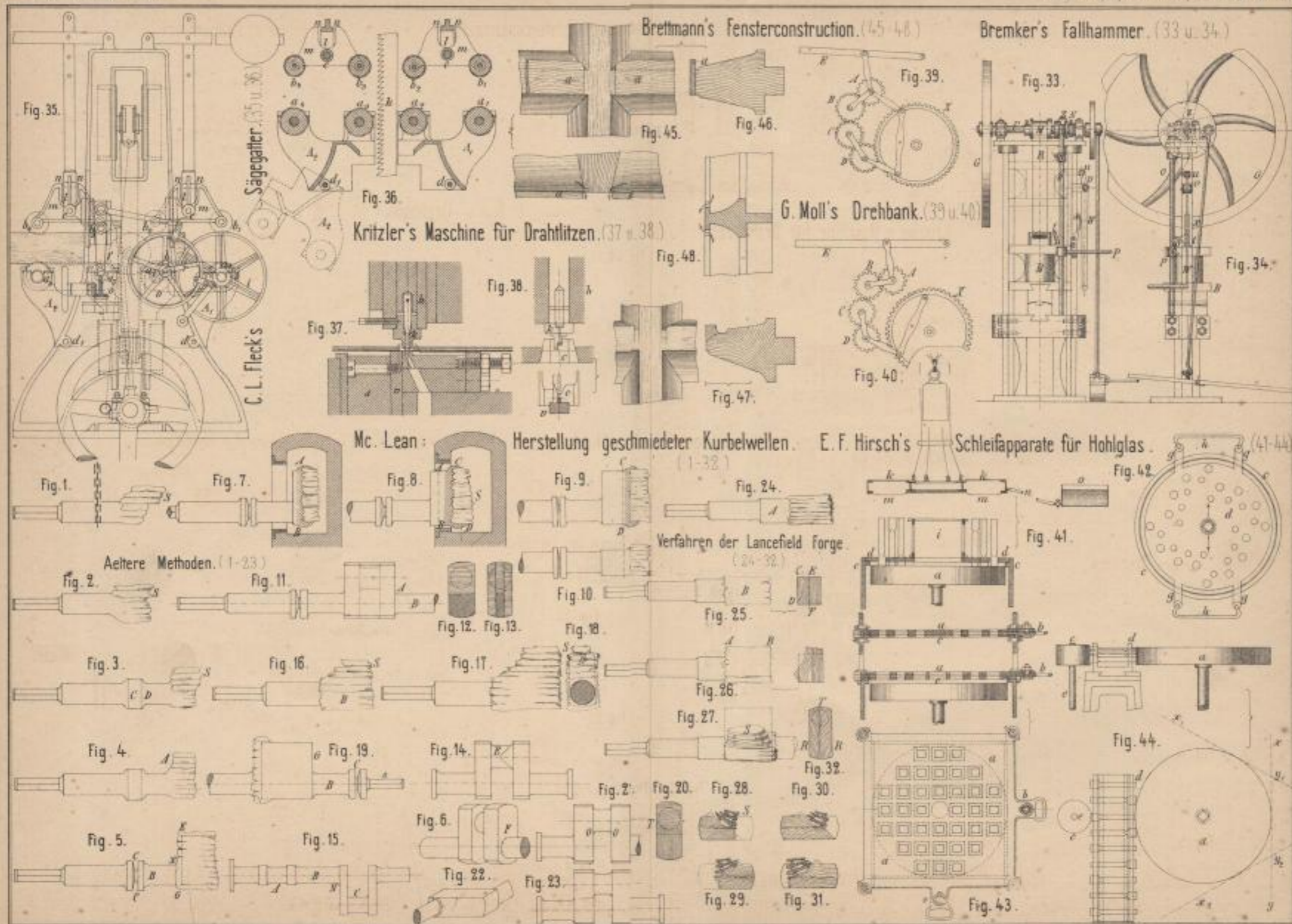

Lith. Anst. v. P. Perle, Braunschweig

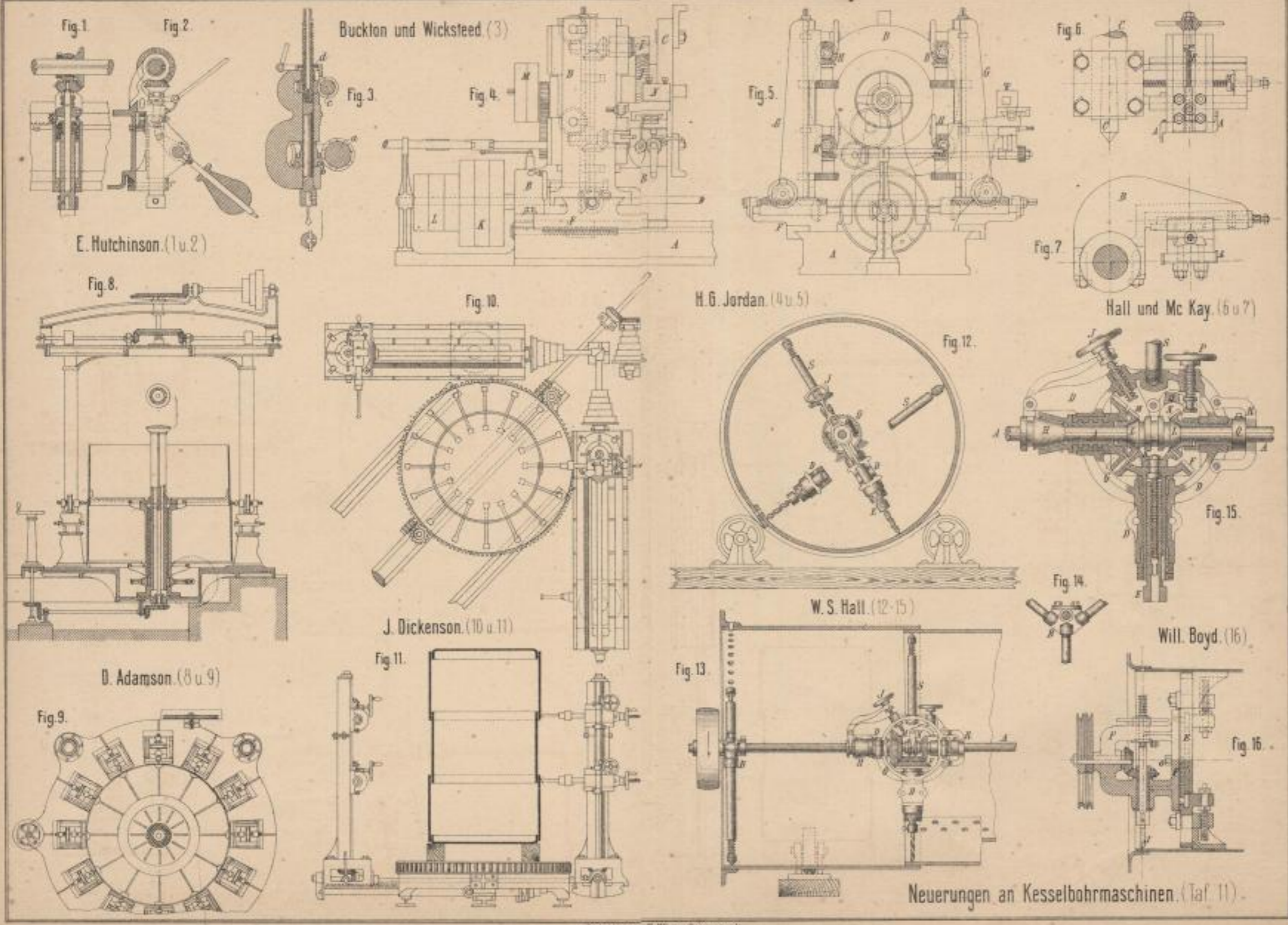

Buckton und Wicksteed (3)

H. G. Jordan (4 u. 5)

W. S. Hall (12-15)

Will. Boyd (16)

Neuerungen an Kesselbohrmaschinen (Taf. 11)

Lith. Anst. v. F. Wiese, Darmstadt

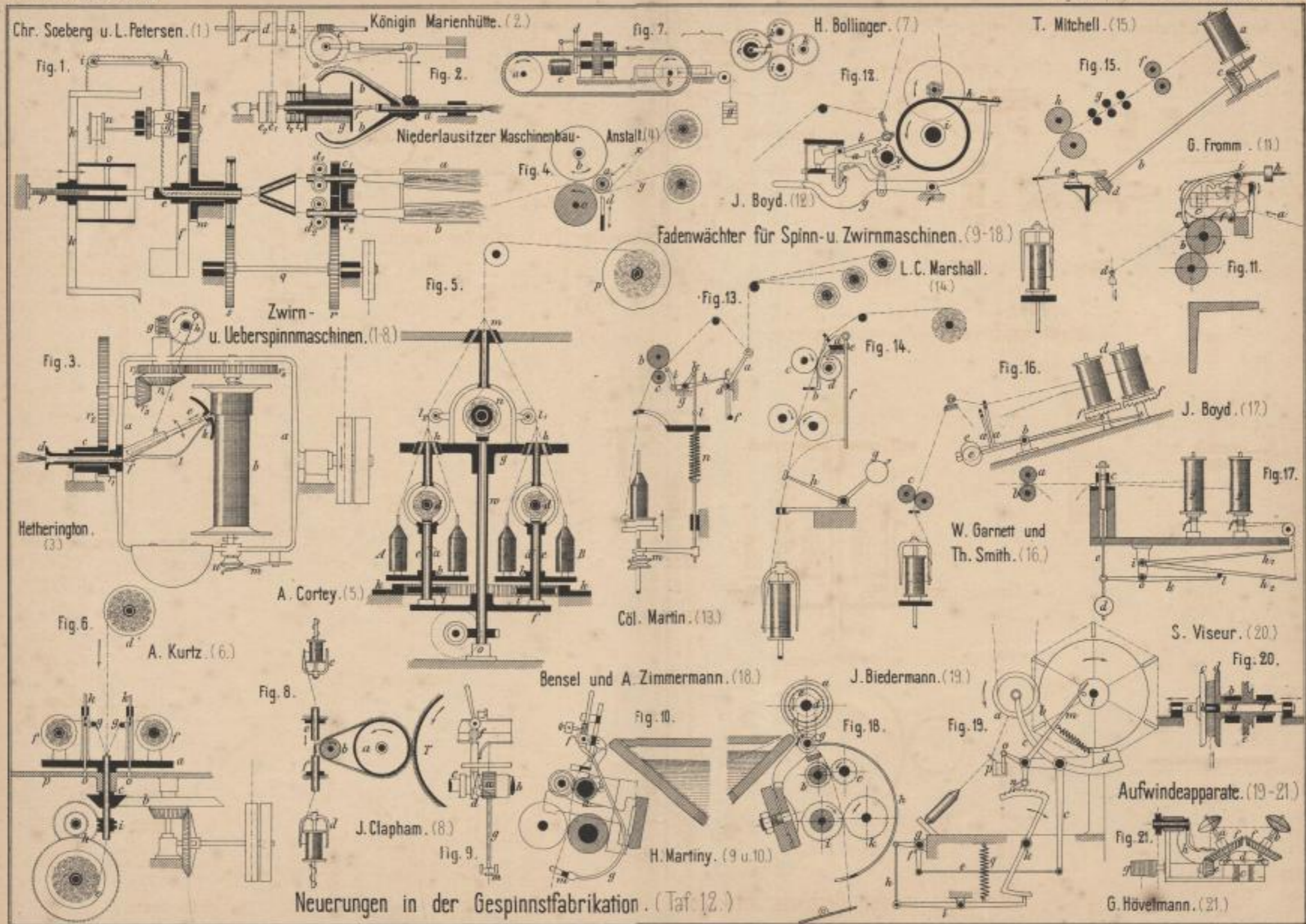

Neuerungen in der Gespinnstfabrikation. (Taf. 12.)

Leh. Dr. P. Wirtz, Darmstadt



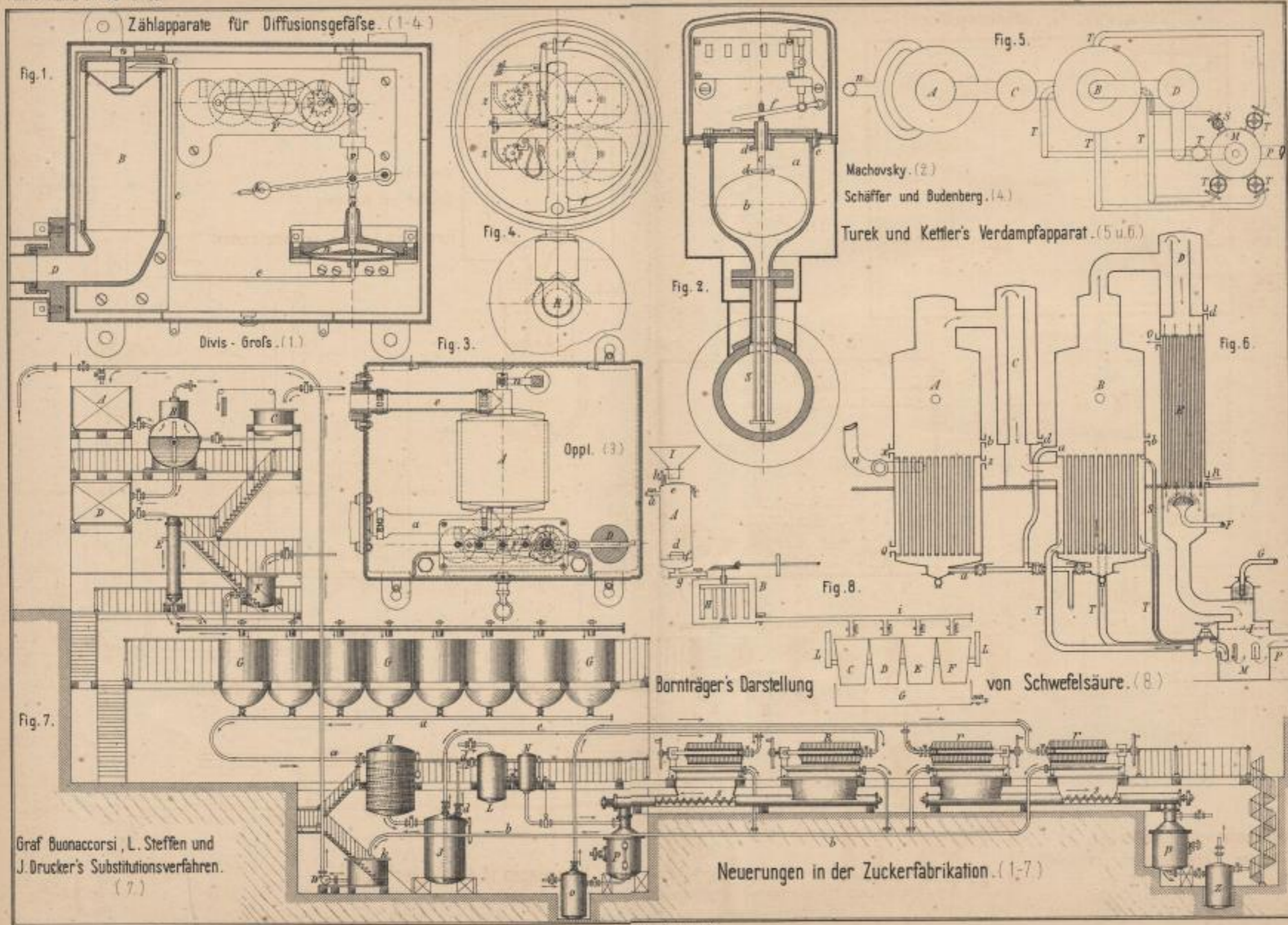

Lith. Anst. v. F. Pirte, Darmstadt.

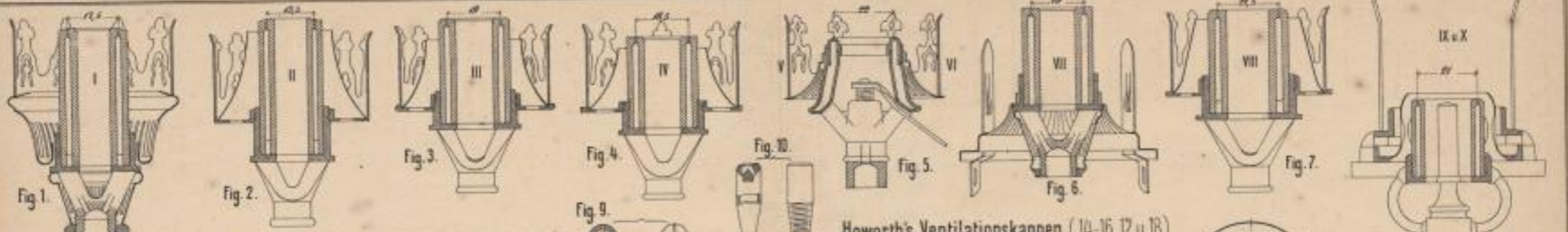

Howorth's Ventilationskappen. (14-16, 17 u. 18)

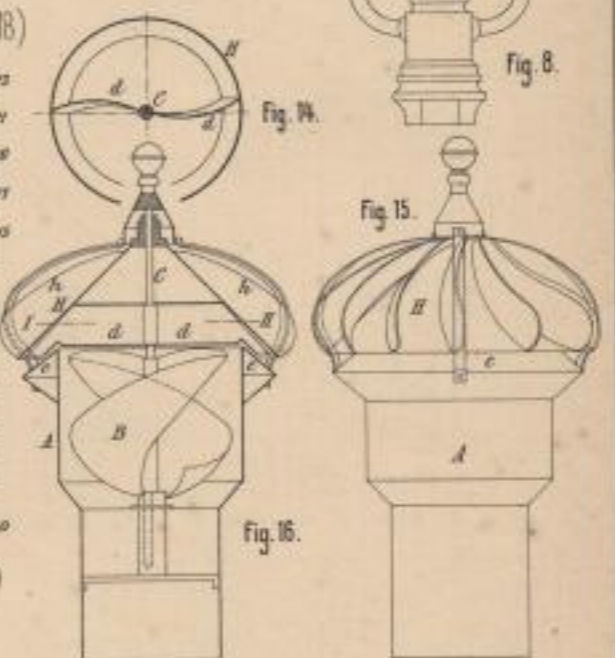
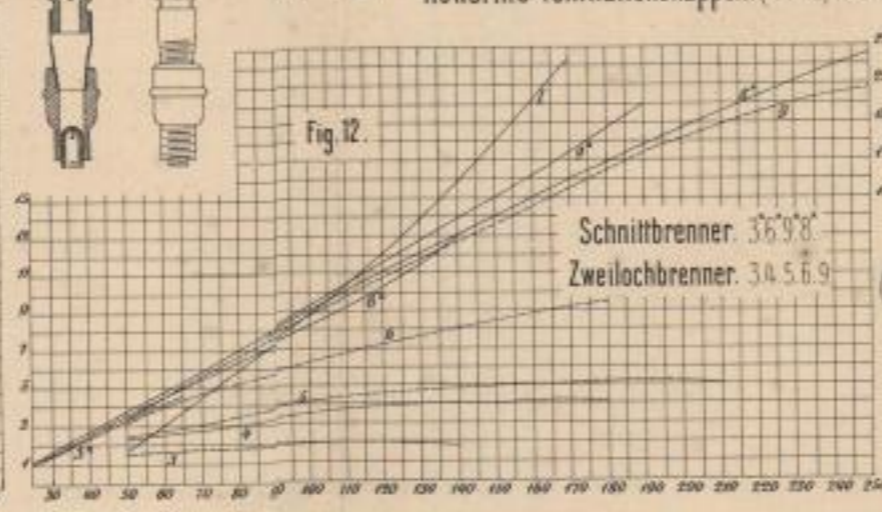
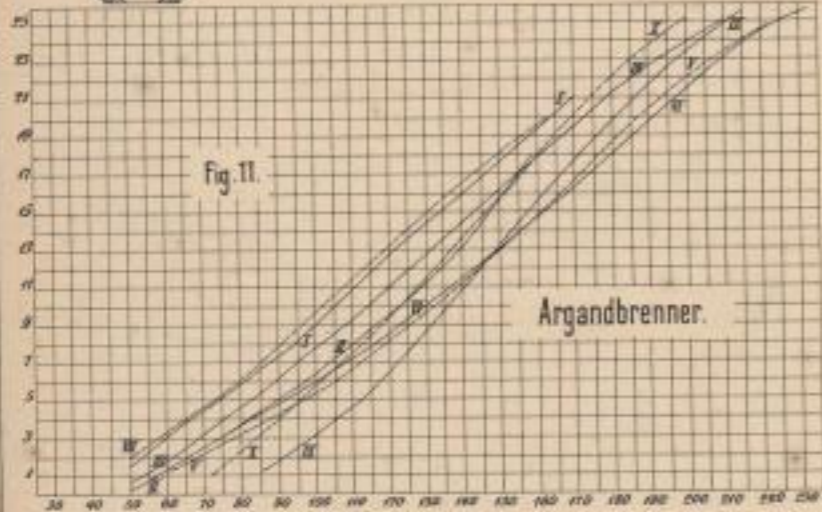

Rüdorff: Leistung der gebräuchlichsten Gasbrenner. (1-12)

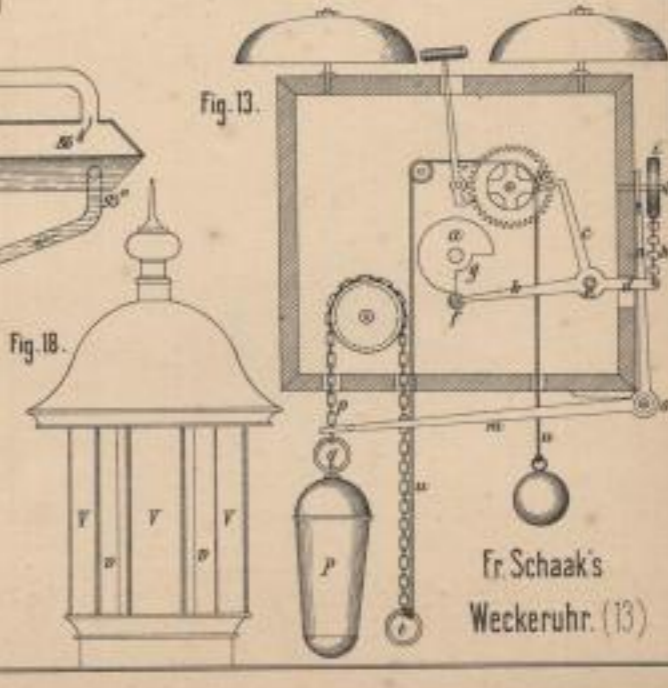
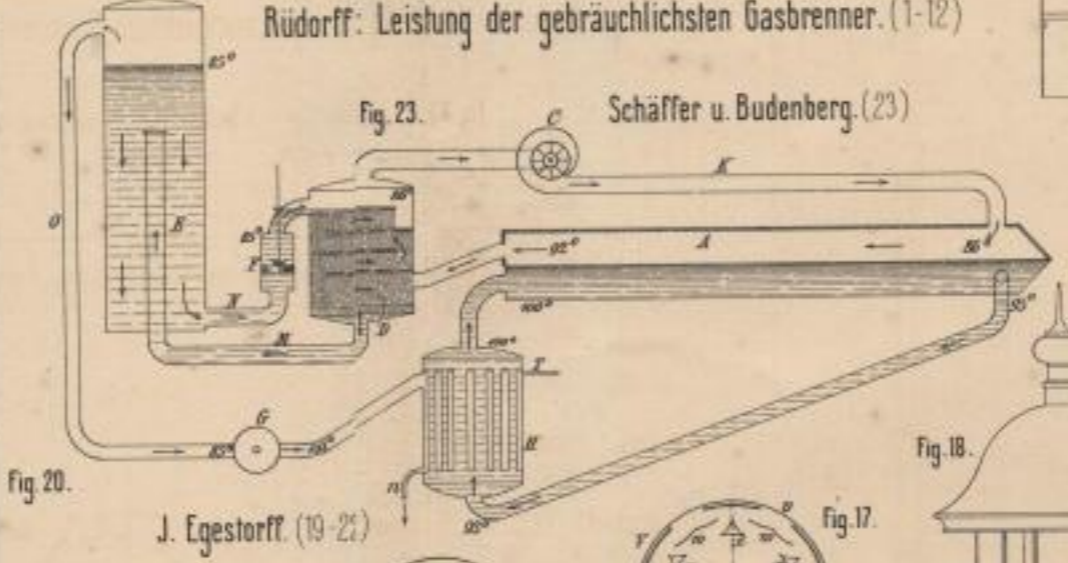
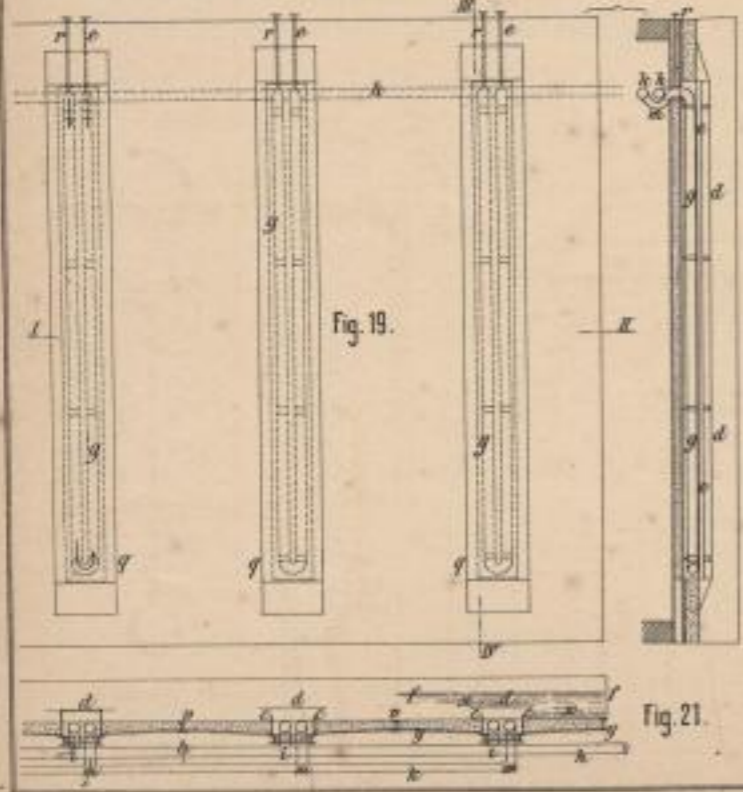

Klith. Anst. v. F. Wiese, Darmstadt.

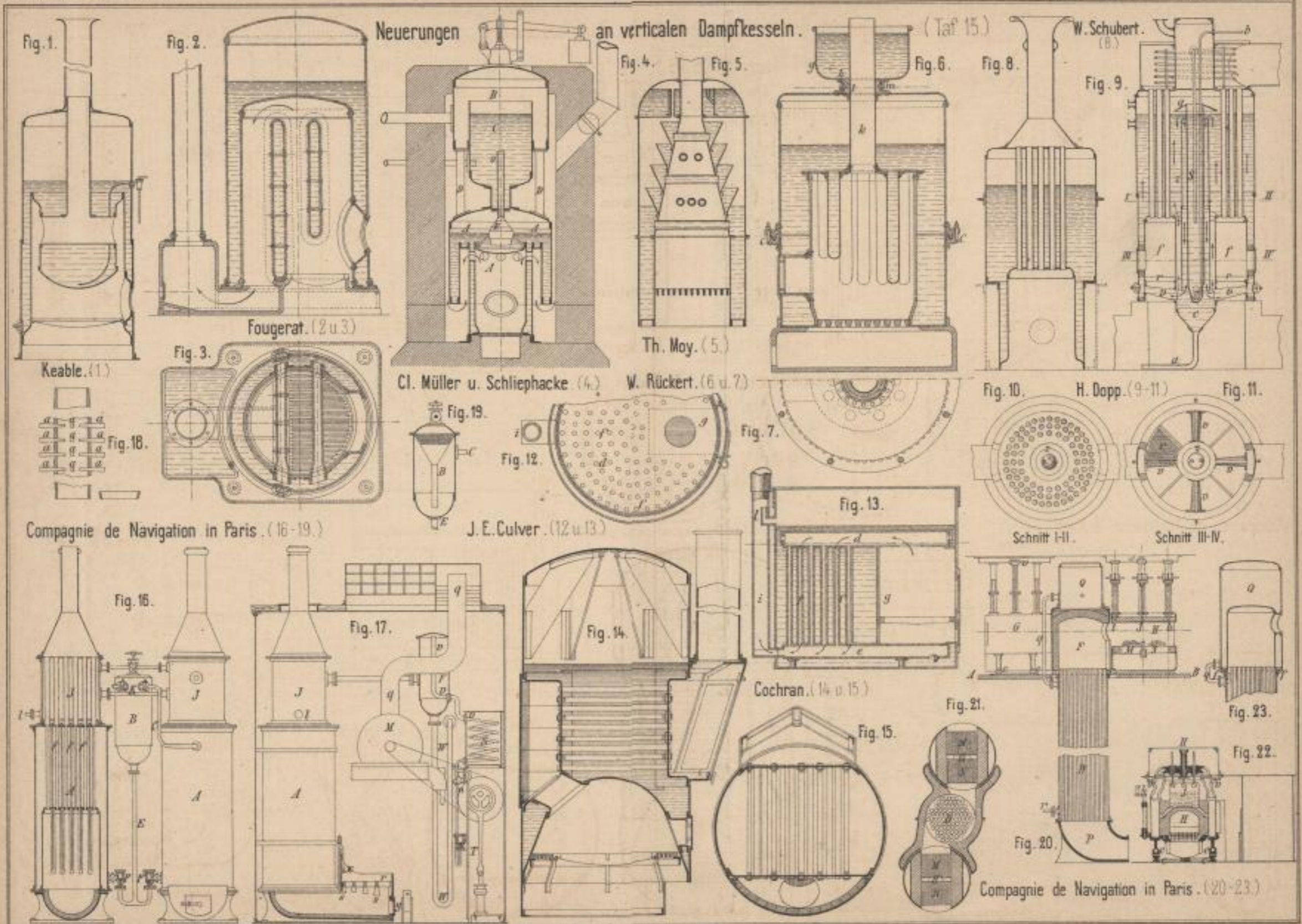

Taf. 15. v. F. W. v. W. v. W. v. W.

E. Rosi's Ventilsteuerungen. (1-5)

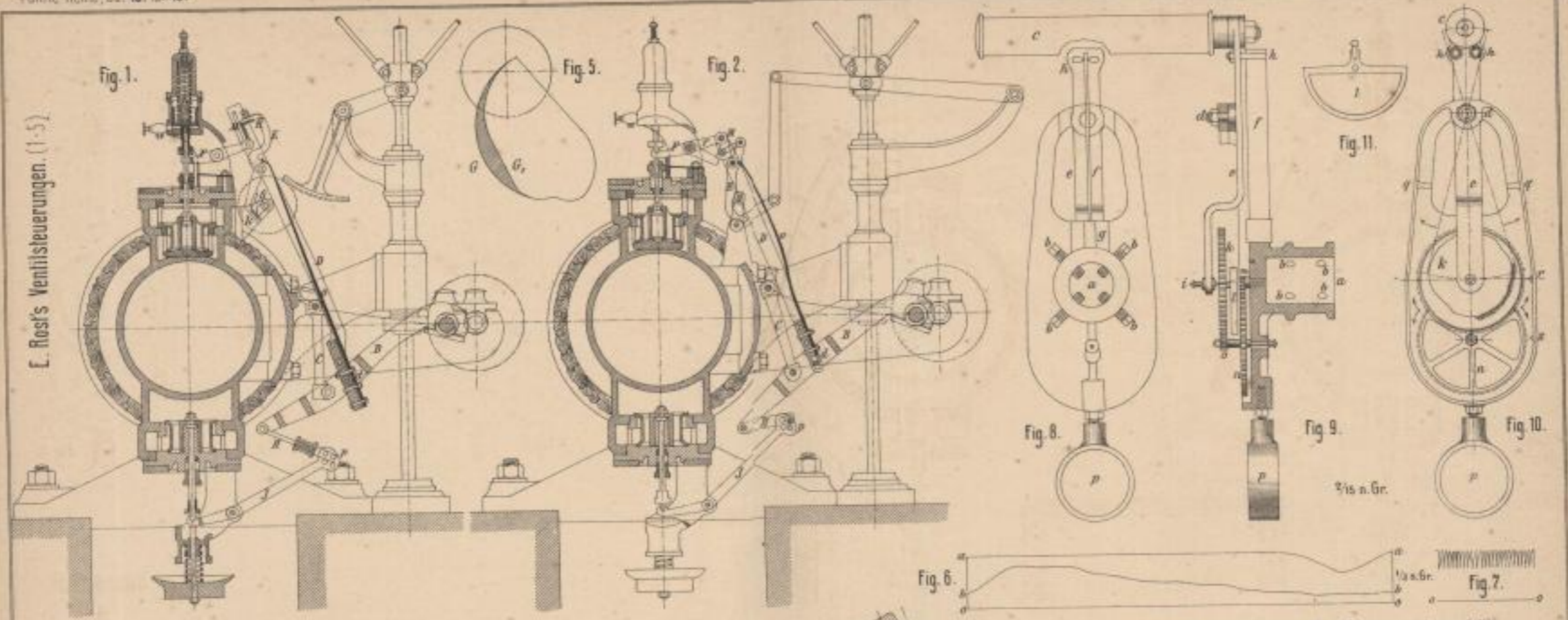

Wüst's Kurbelkraftmesser. (6-11)

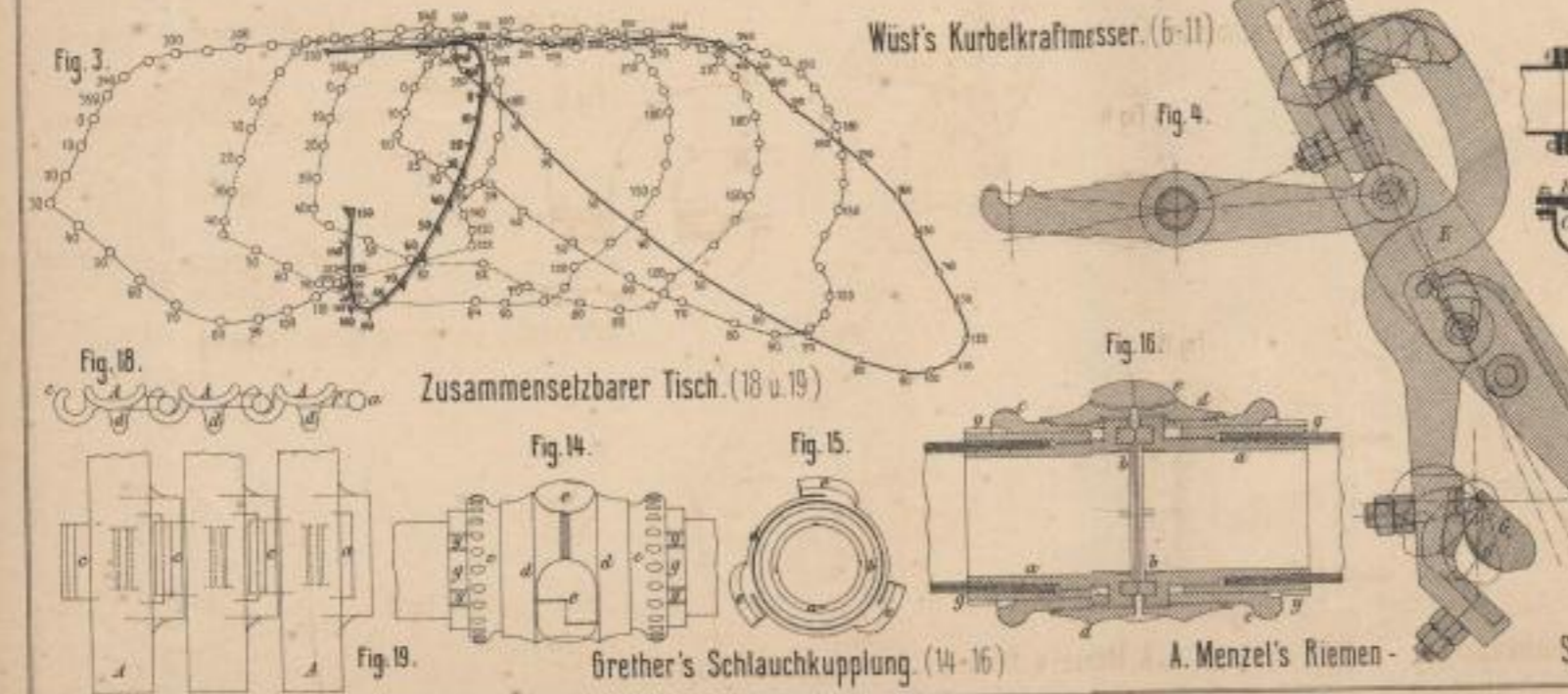

Liernur's Muffendichtung für Steingutröhren. (17)

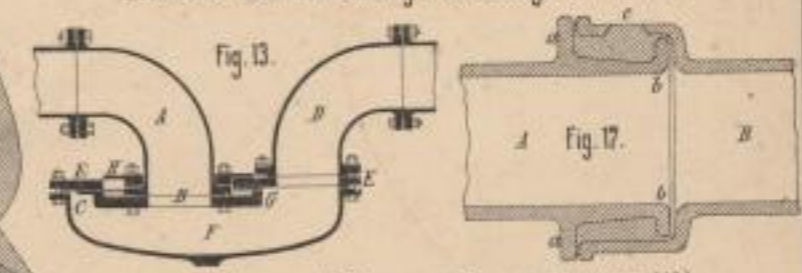

Lührmann's Compensationsvorrichtung. (13)

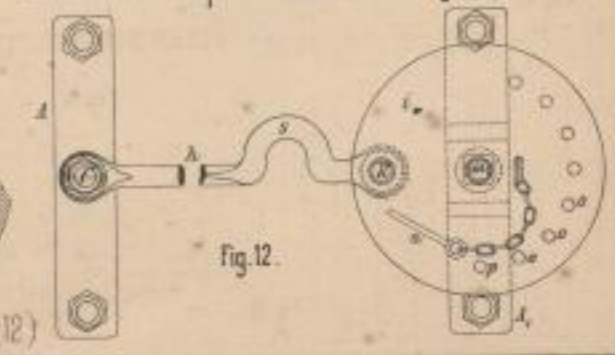

Zusammensetzbarer Tisch. (18 u. 19)

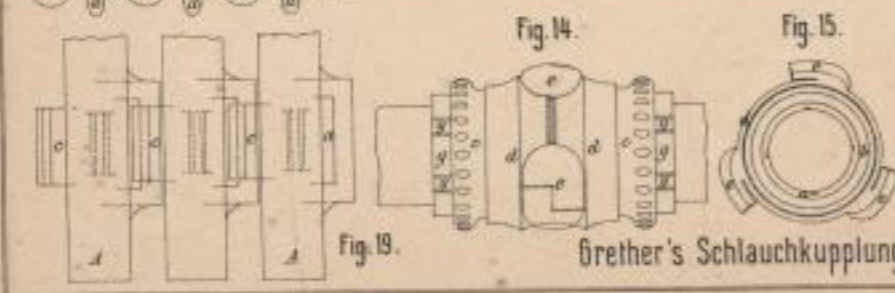

Grether's Schlauchkupplung. (14-16)

A. Menzel's Riemen-Spanner. (12)

Verf. des. u. F. Wirtz, Darmstadt.

Mehlis und Behrens' Strafsen-

Dampfwalze. (1-5)

Cuvier's Hängelager (6-8)

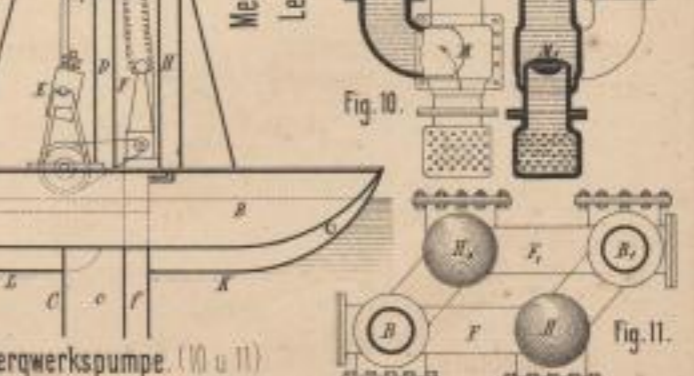
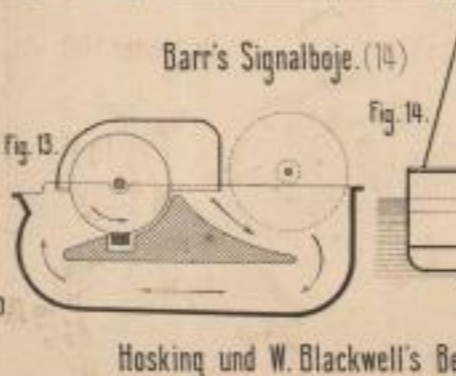
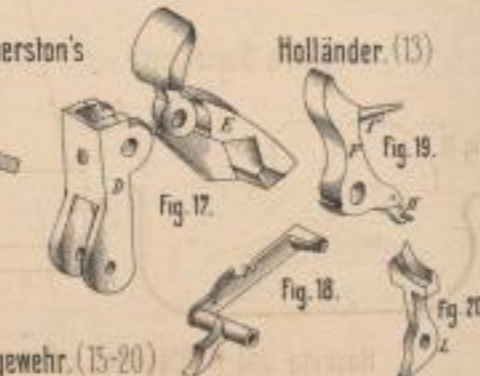
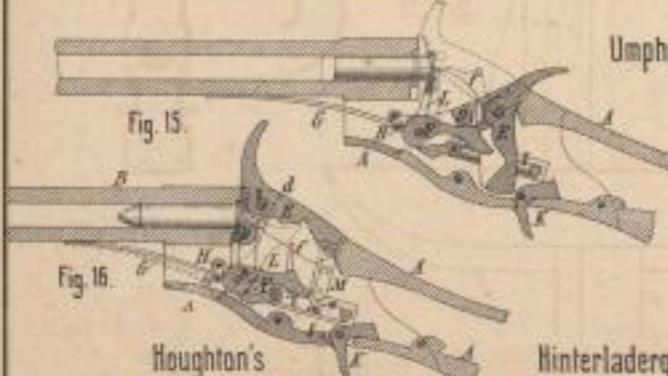
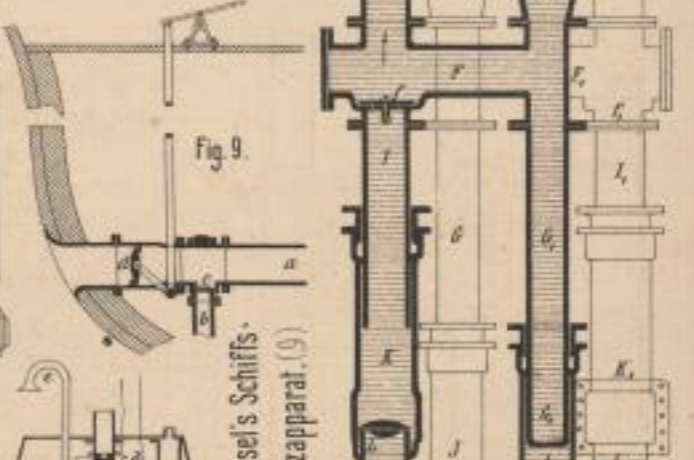
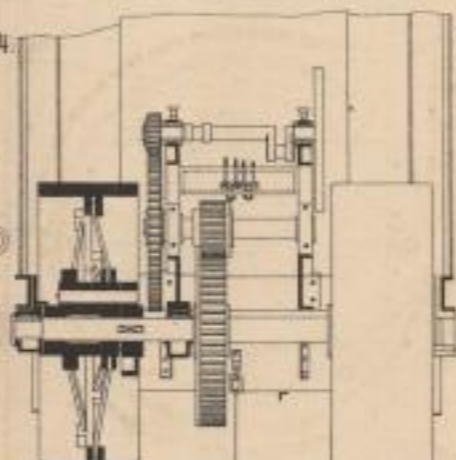
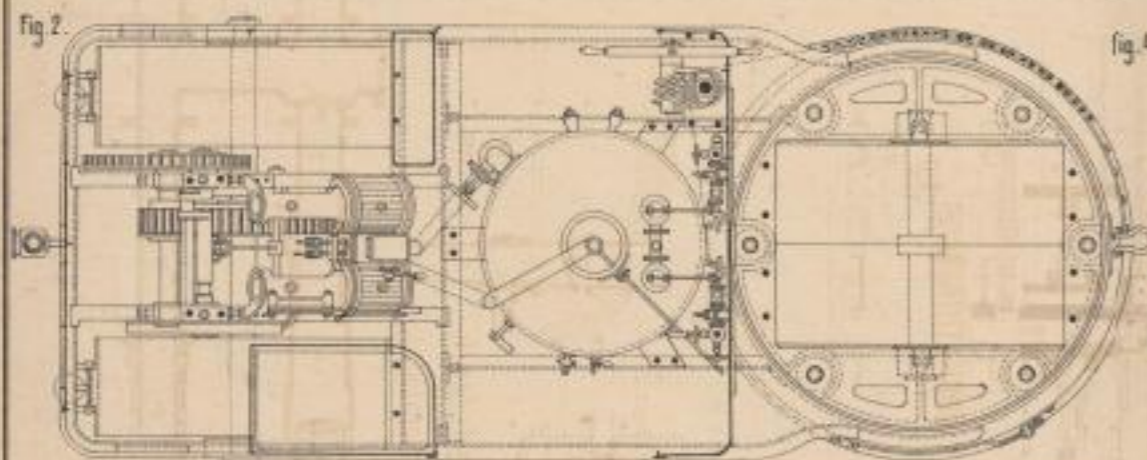
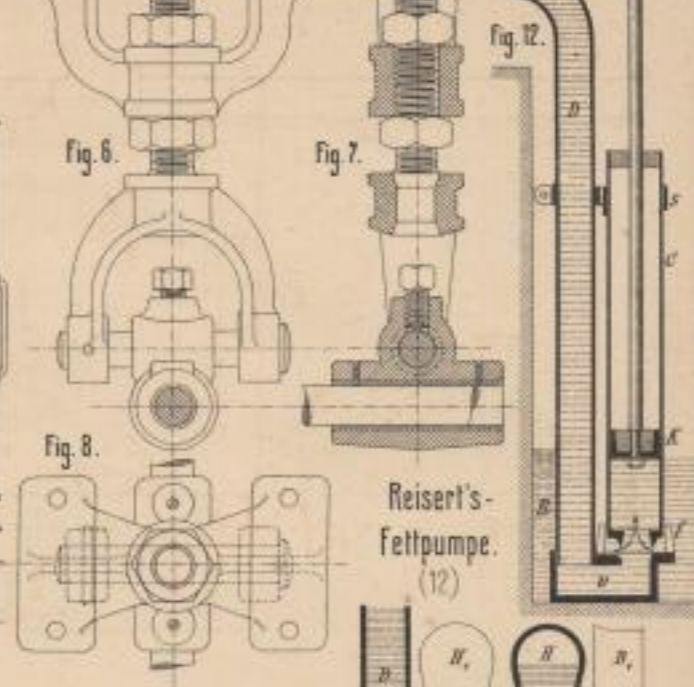
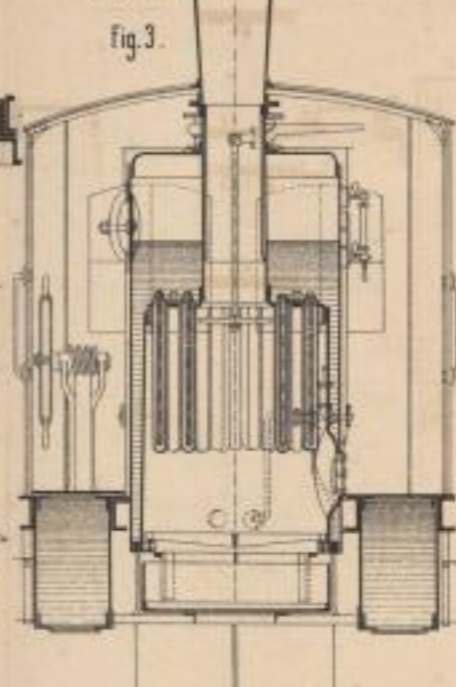
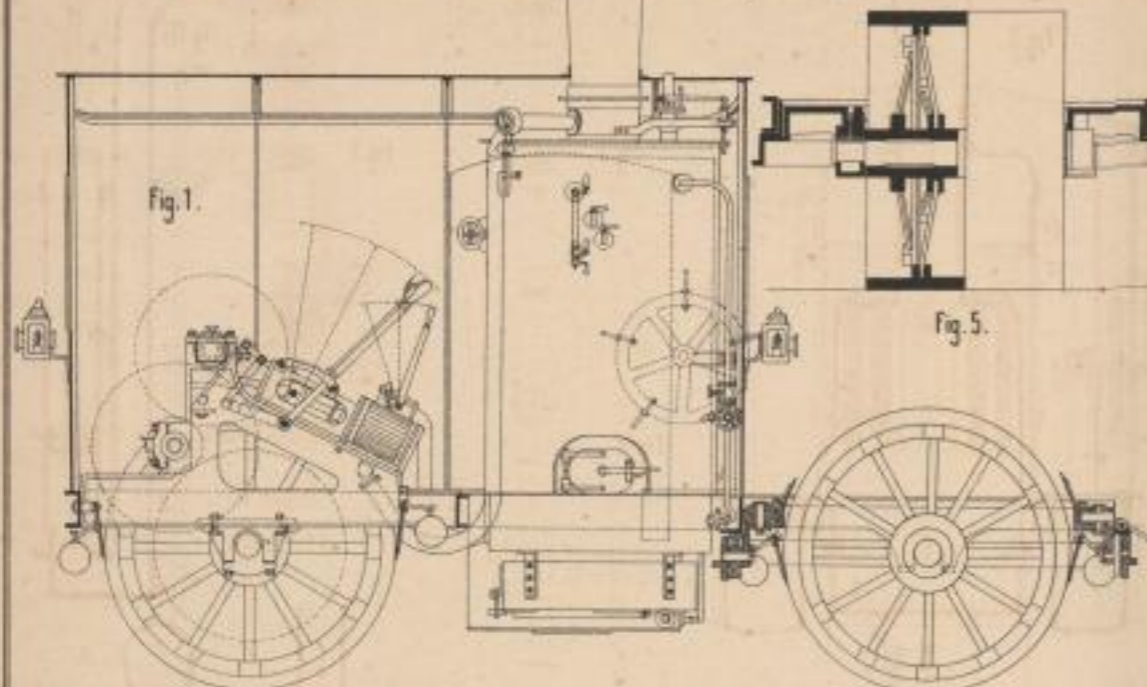

Houghton's

Hinterladergewehr. (15-20)

Holländer. (13)

Hosking und W. Blackwell's Bergwerkspumpe. (10 u 11)

Reiser's Feltpumpe. (12)

Lehr. Anst. F. Witte, Darmstadt

Fangvorrichtungen für Fördertonnen. (18-20 u. 21-25.)

Fig. 12.

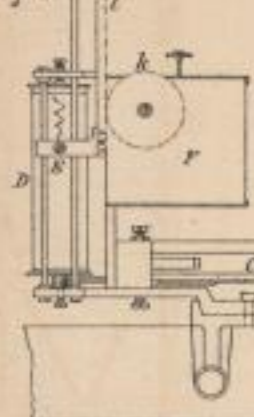

Fig. 15.

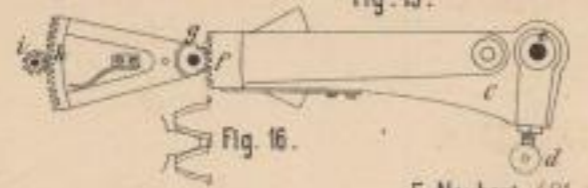

Fig. 16.

F. Neubert. (21-25)

Fig. 21.

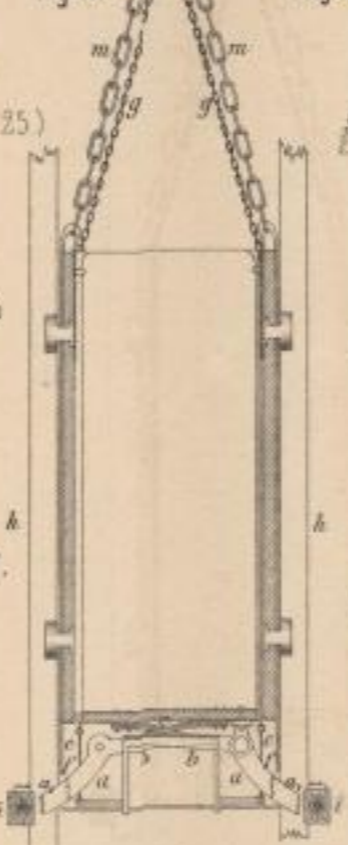

Fig. 22.

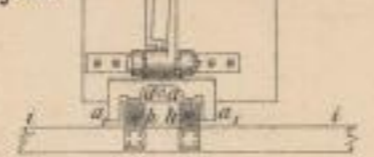

Fig. 18.

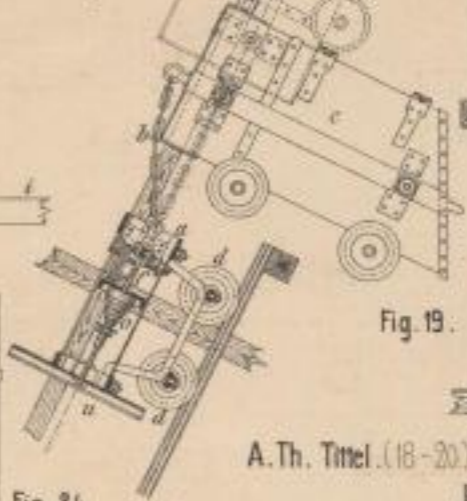
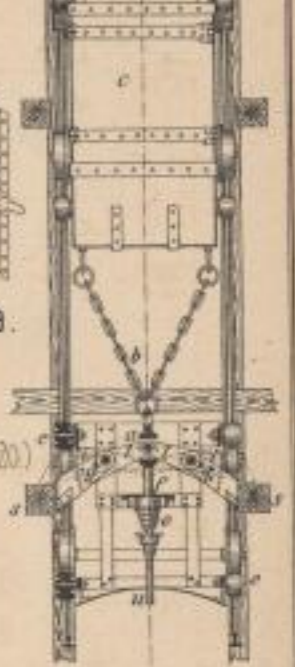

Fig. 19.



A. Th. Tinel. (18-20)

O. Leuner's Prüfungsapparat. (12-17)

Fig. 13.

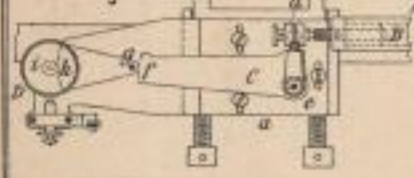

Fig. 14.



Fig. 17.



Neuere Schraffirapparate. (4-11)

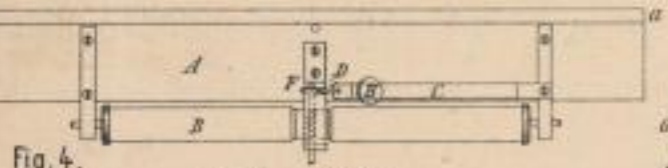
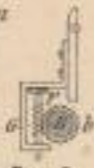

Fig. 4.

Fig. 6.



Fig. 5.



O. E. Richter. (4-6.)

Hellmann. (7.)

Fig. 7.

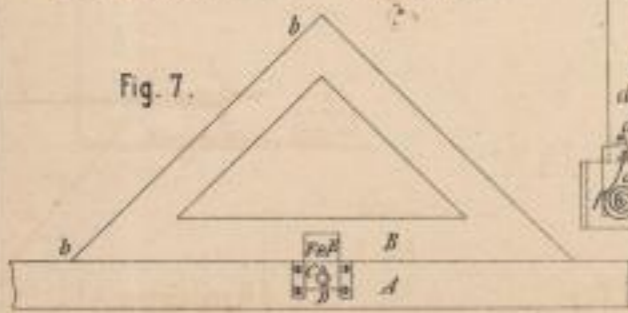
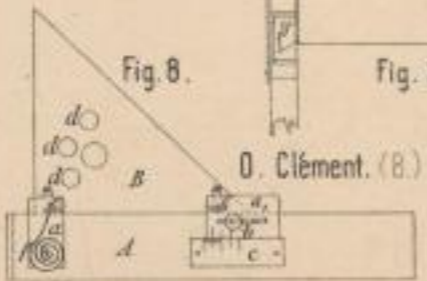

Fig. 8.



O. Clément. (8.)

Wismann und Wallegg. (9-11)

Fig. 23.

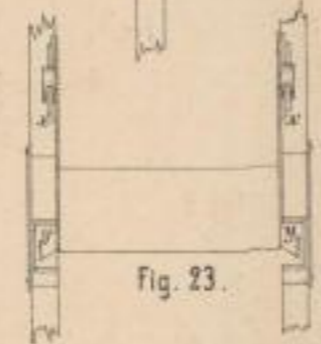

Fig. 9.

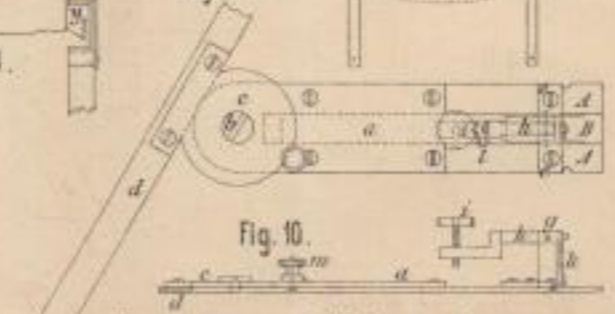

Fig. 10.



Kiesewalter und Hohaus' Löthapparat für

Fig. 1.

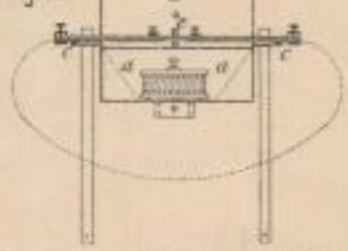

Fig. 24.

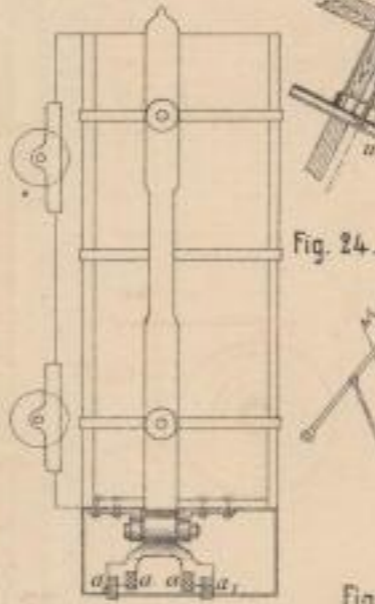

Fig. 25.

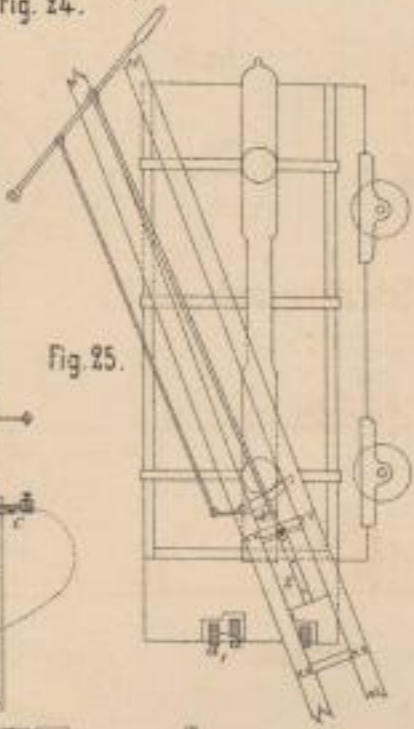

Fig. 20.

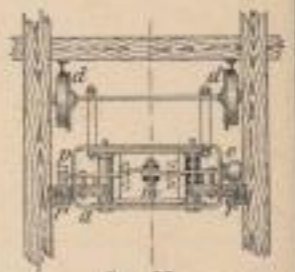

Fig. 2.



Fig. 11.



Fig. 3.

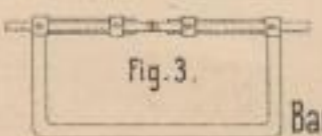

Bandsägen. (1-3.)

Lith. Anst. v. F. Wirtz, Darmstadt



P. Morane's Maschinen für Kerzengießerei. (14-20)

Huckert's Läuteuhr. (1-3.)

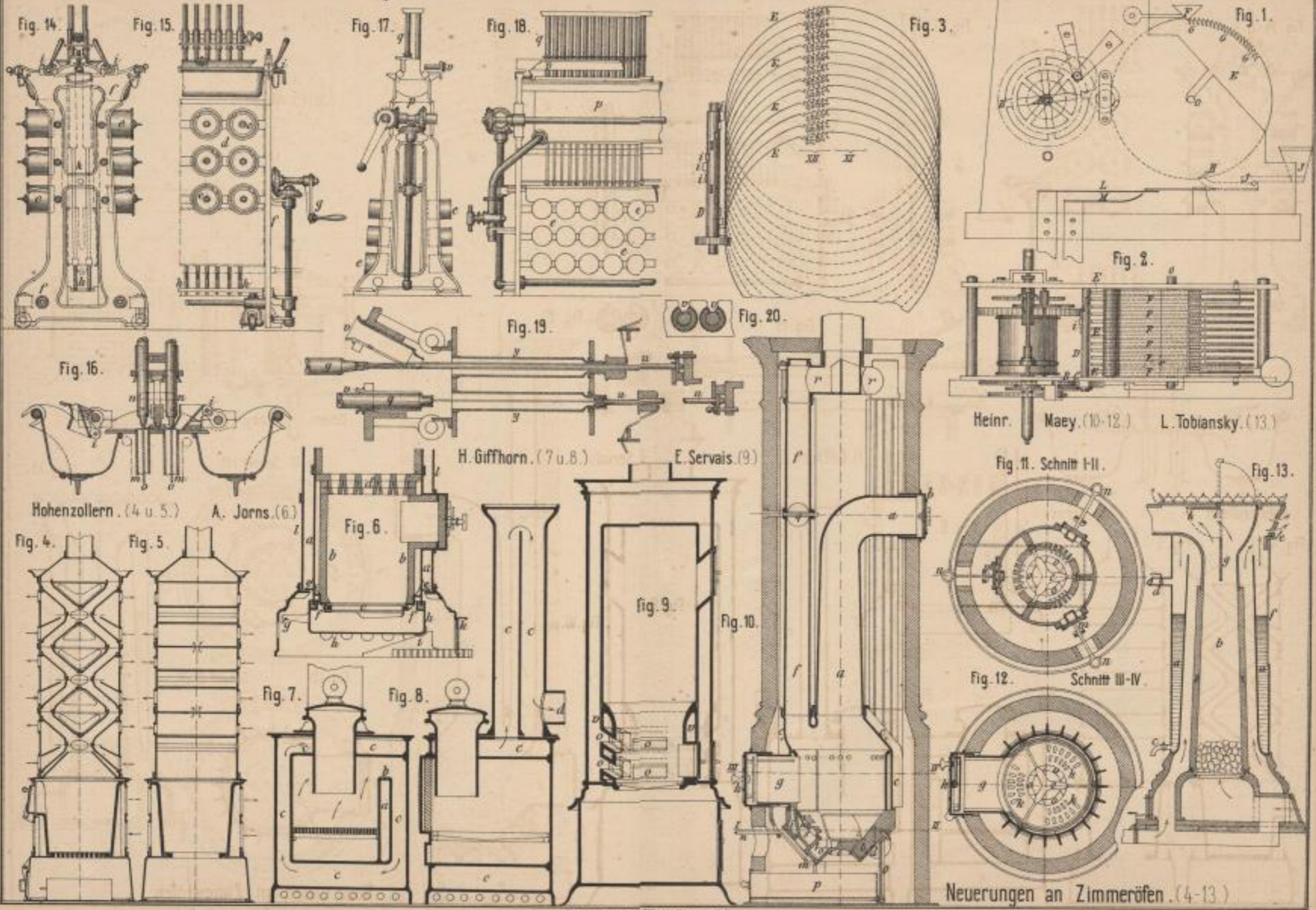

Hohenzollern. (4 u. 5.) A. Jorns. (6.)

H. Giffhorn. (7 u. 8.) E. Servais. (9.)

Heinr. Maey. (10-12.) L. Tobiansky. (13.)

Neuerungen an Zimmeröfen. (4-13.)

Lab. Anst. v. F. Wirtz, Darmstadt.

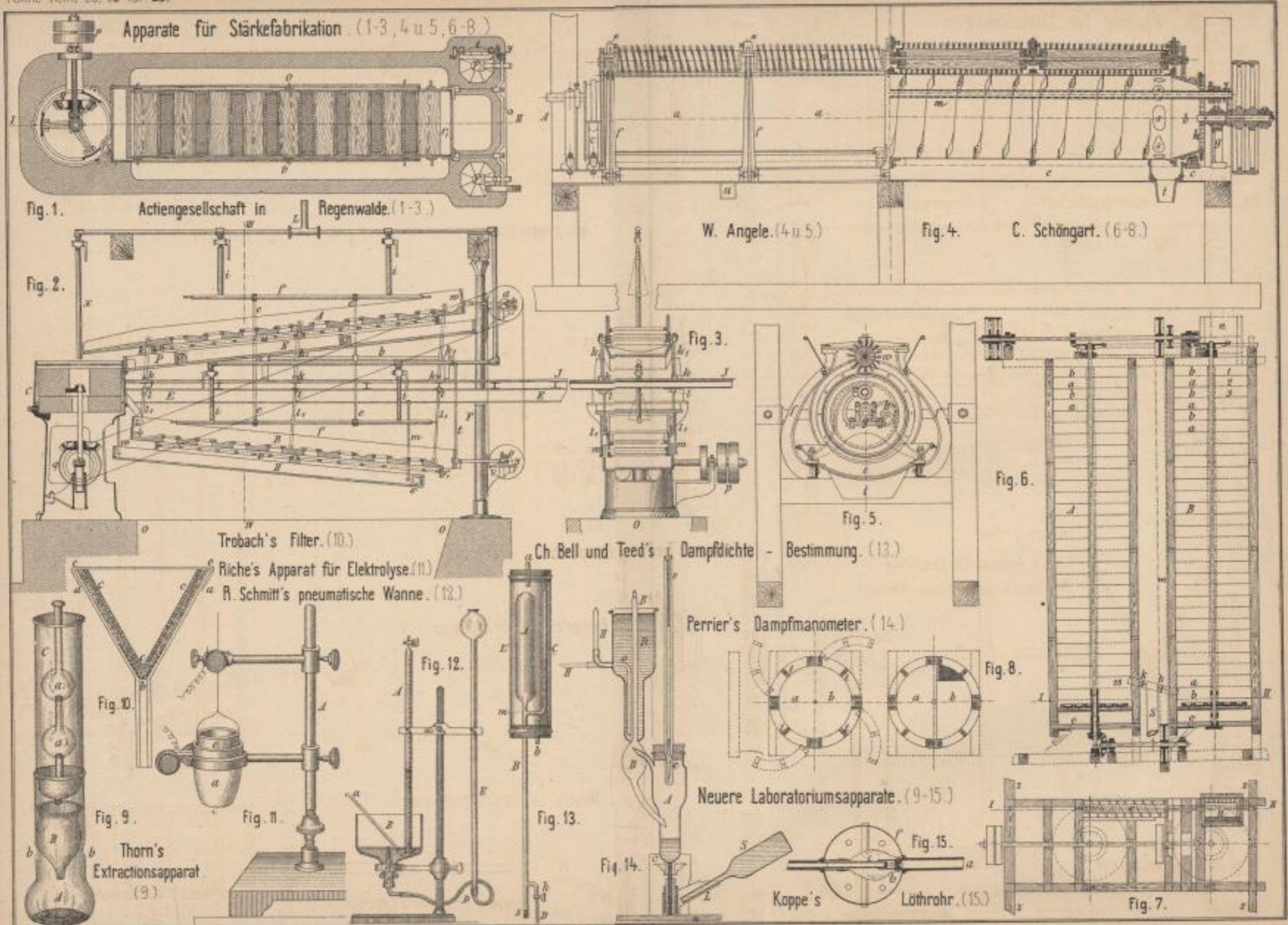

Leib. Anst. v.F. Wirtz, Darmstadt.

Neuerungen in der Bierbrauerei. (Taf. 21)

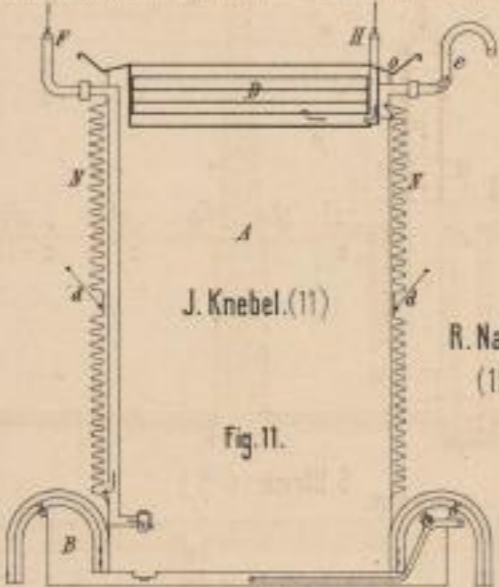
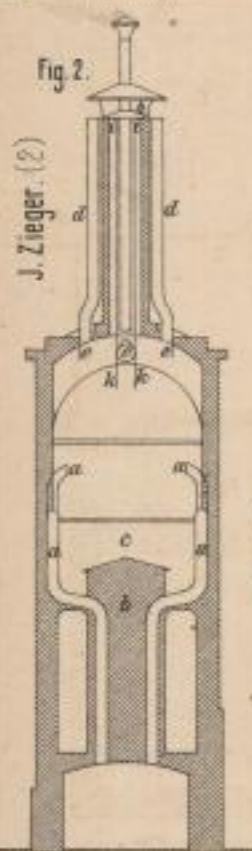
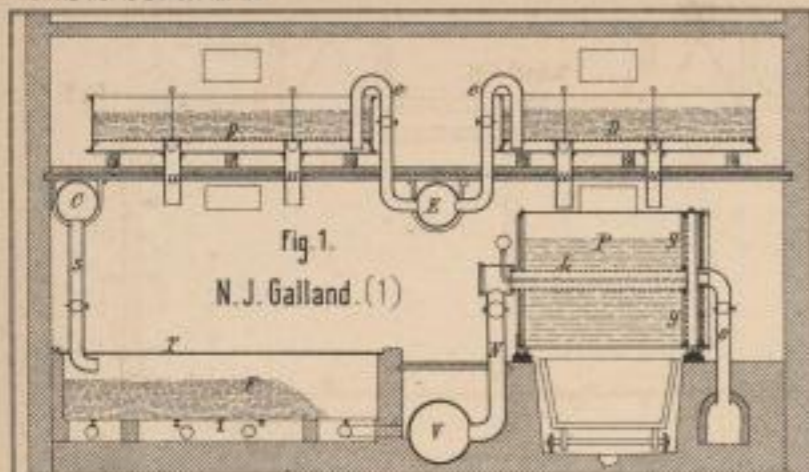

R. Nagel. (12)

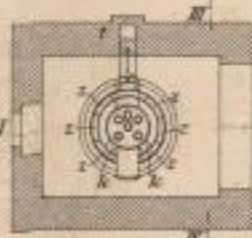
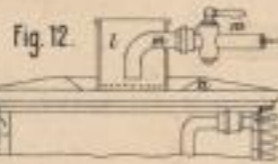

S. Ulrich. (6-8)

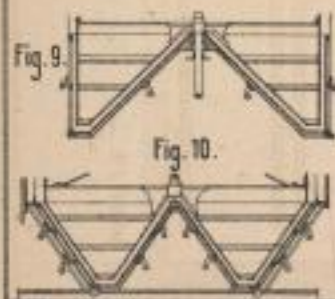

E. Welz und A. Ritter. (9 u 10)

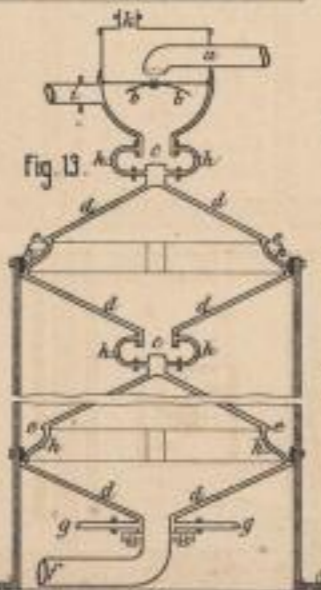

L. Heyer und J. Wagner. (13)



B. Wolf. (14)

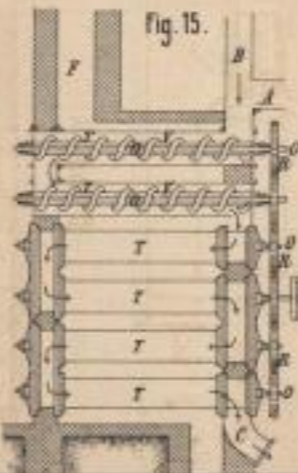

L. Paulus und Guérout. (15)

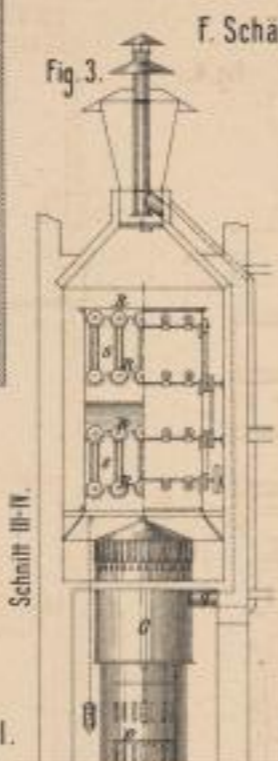

F. Schäfer. (3-5)

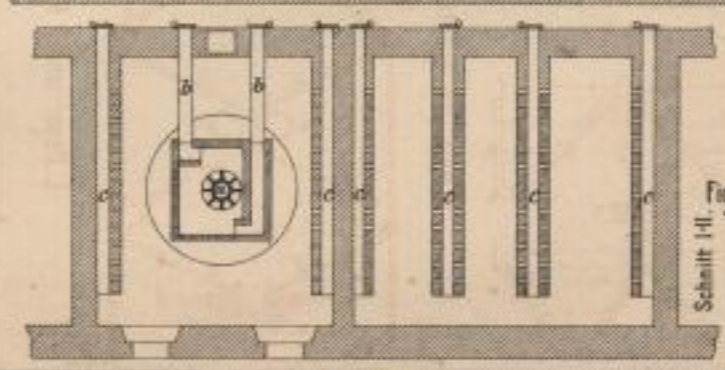
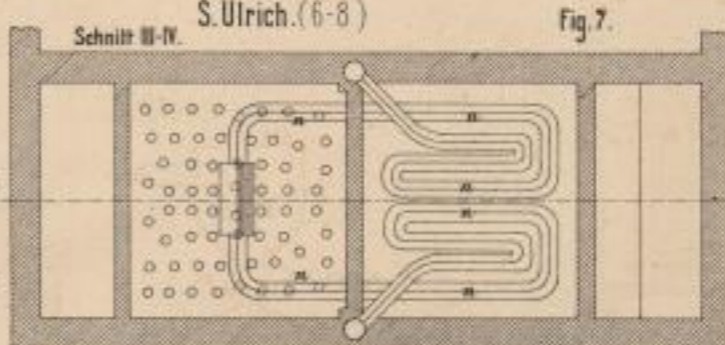
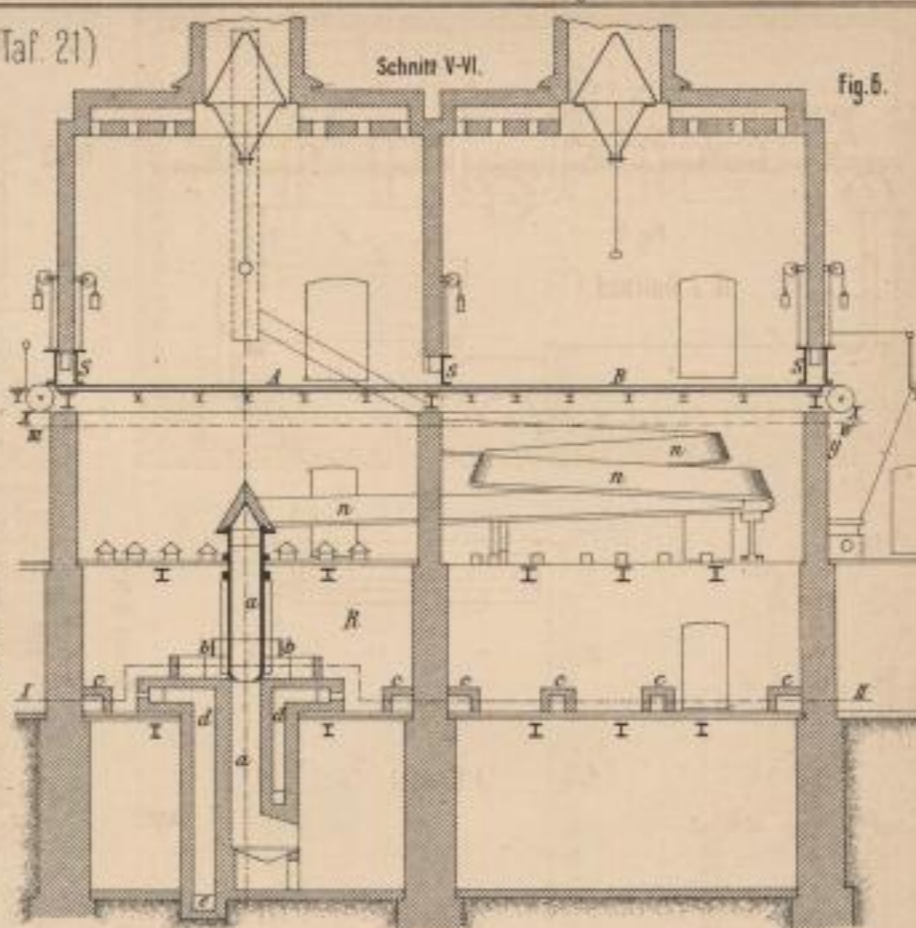
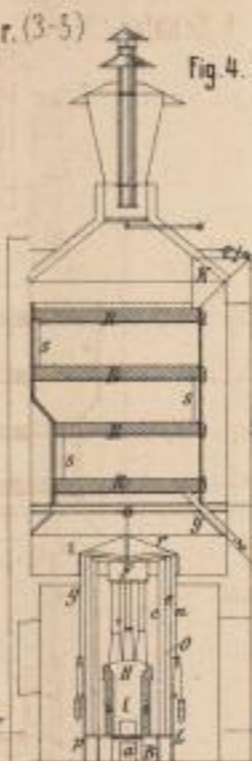

Lith. Anst. v. F. Wirtz, Darmstadt.

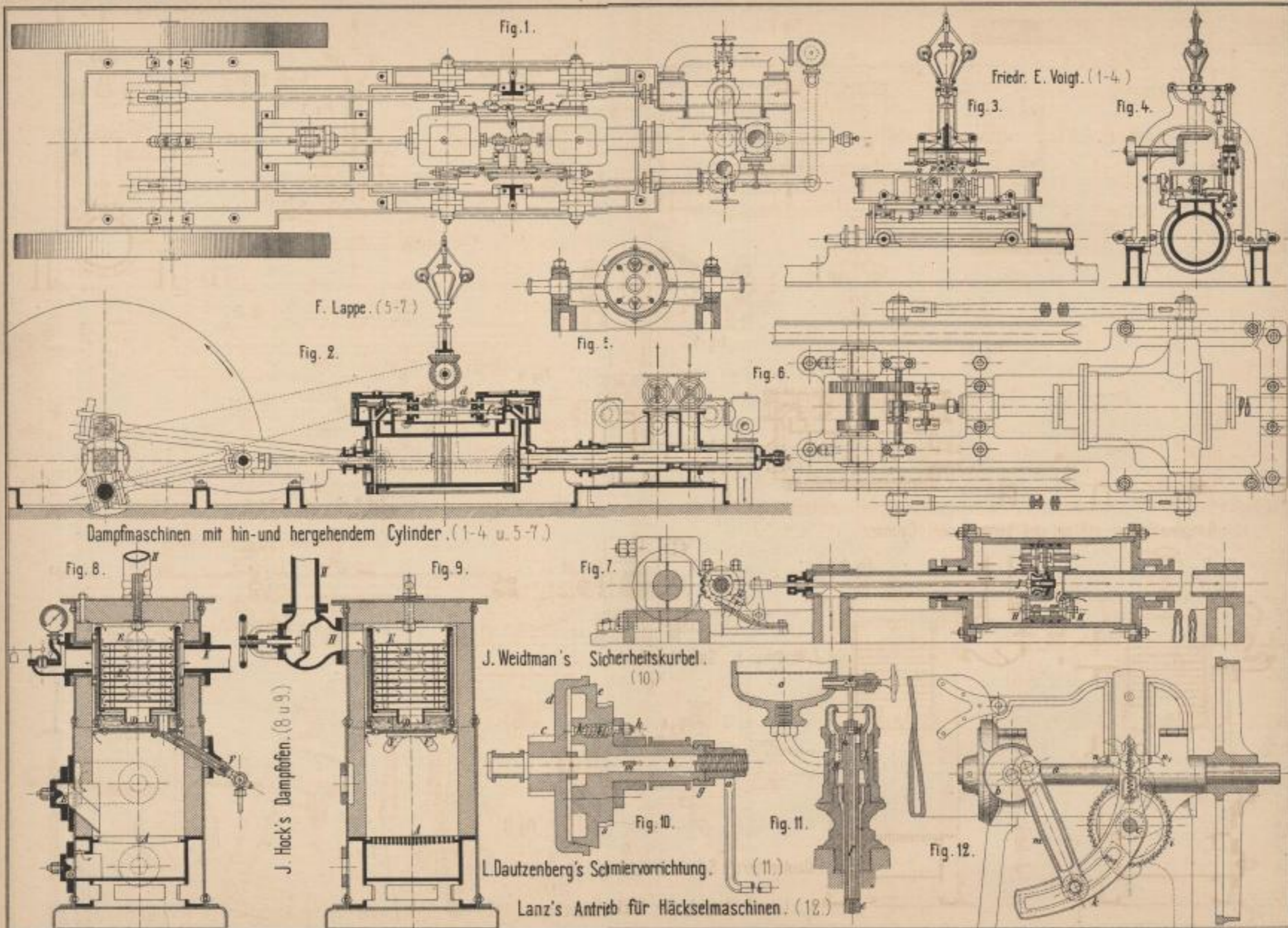

Dampfmaschinen mit hin- und hergehendem Cylinder. (1-4 u. 5-7.)

J. Weidman's Sicherheitskurbel. (10)

J. Hock's Dampfbofen. (8 u. 9.)

L. Dautzenberg's Schmiervorrichtung. (11.)

Lanz's Antrieb für Häckselmaschinen. (12.)

Lab. Anstalt in P. Wires. Darmstadt.



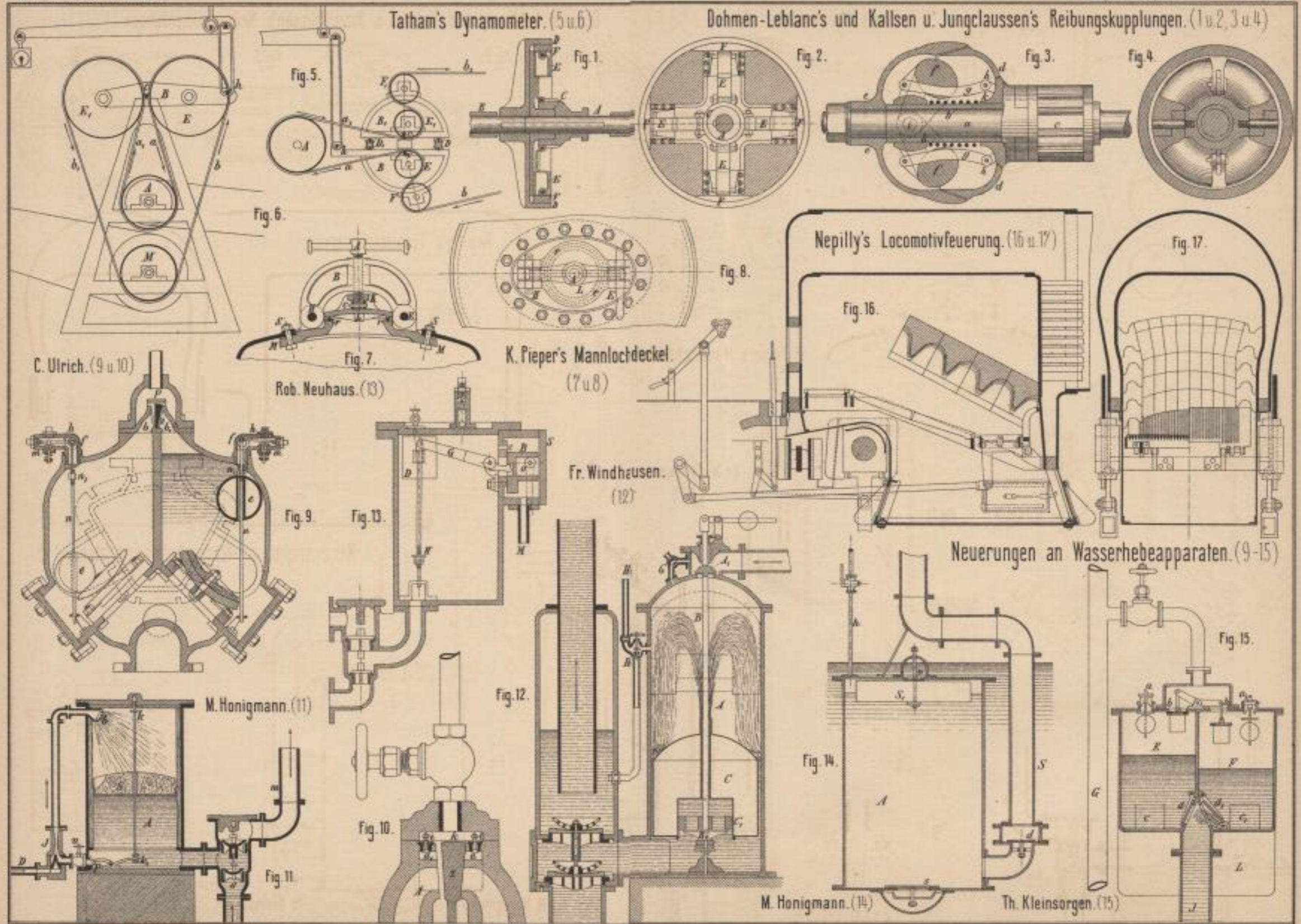

Neuerungen an Tischler- Werkzeugen. (4-16)

Ugè's Formmaschine. (1 u 2) Kircheis' Excenterschere mit Lochapparat. (17)

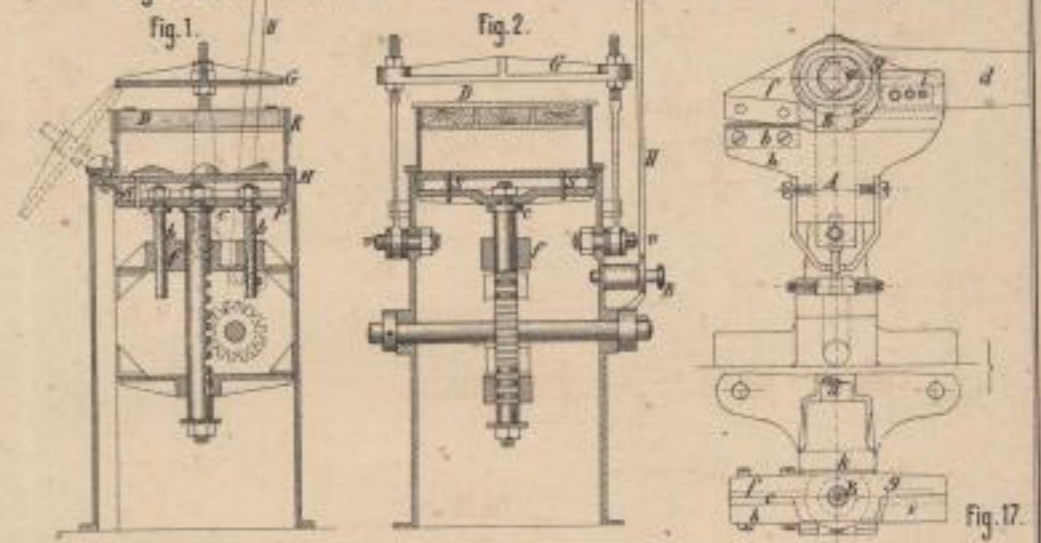
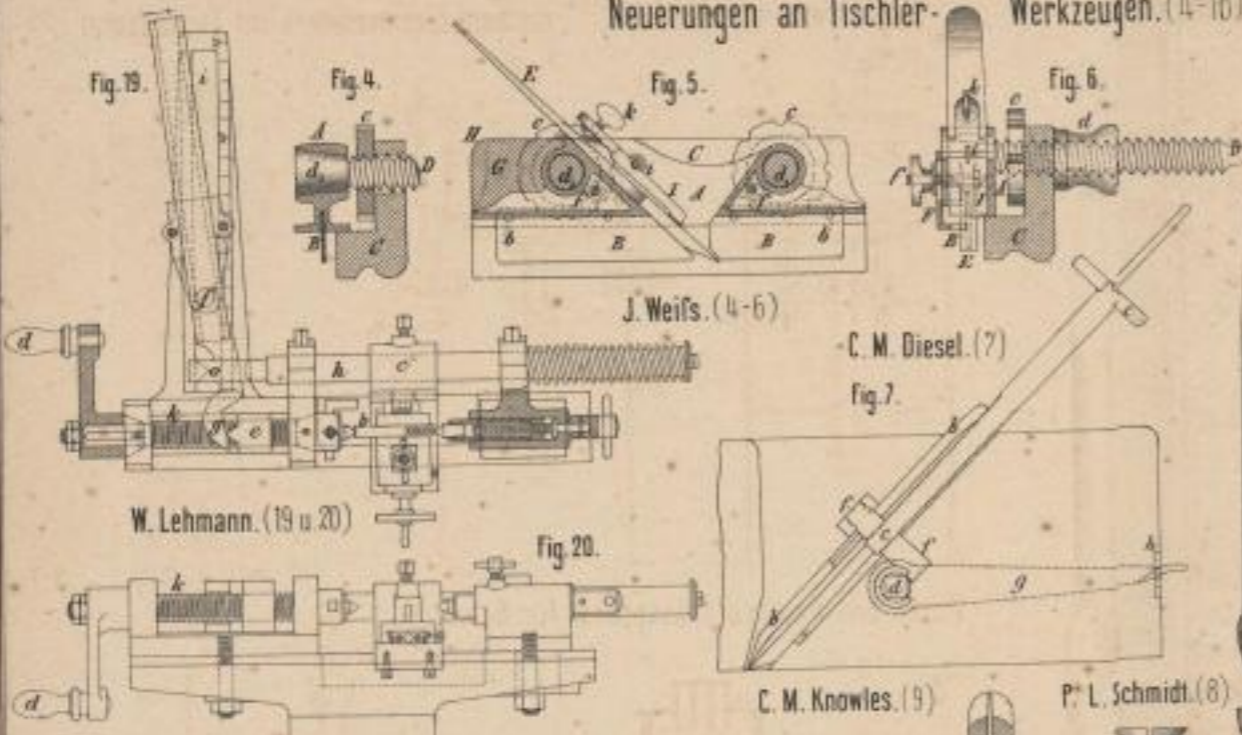

Hurtu und Hautin's Fräsapparat für Bohrer. (18)

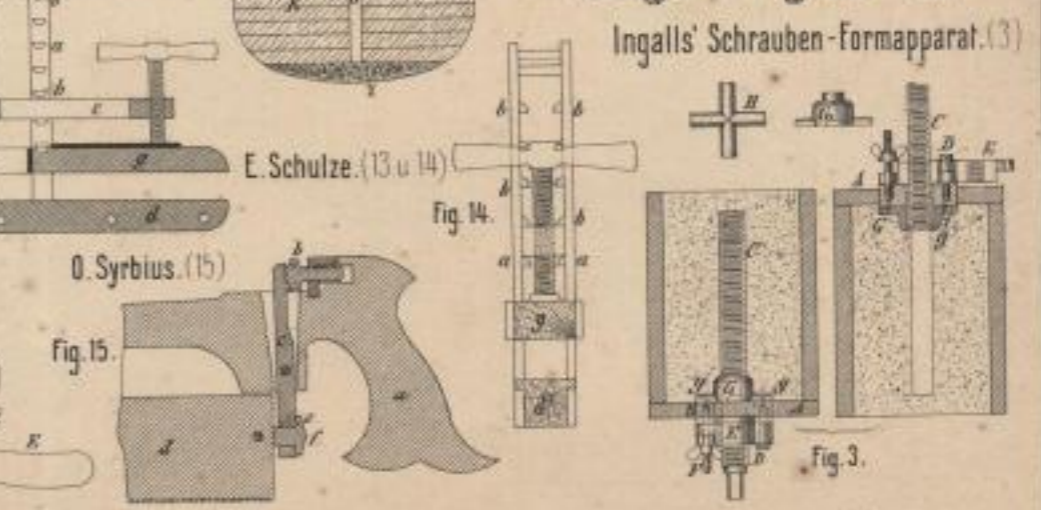
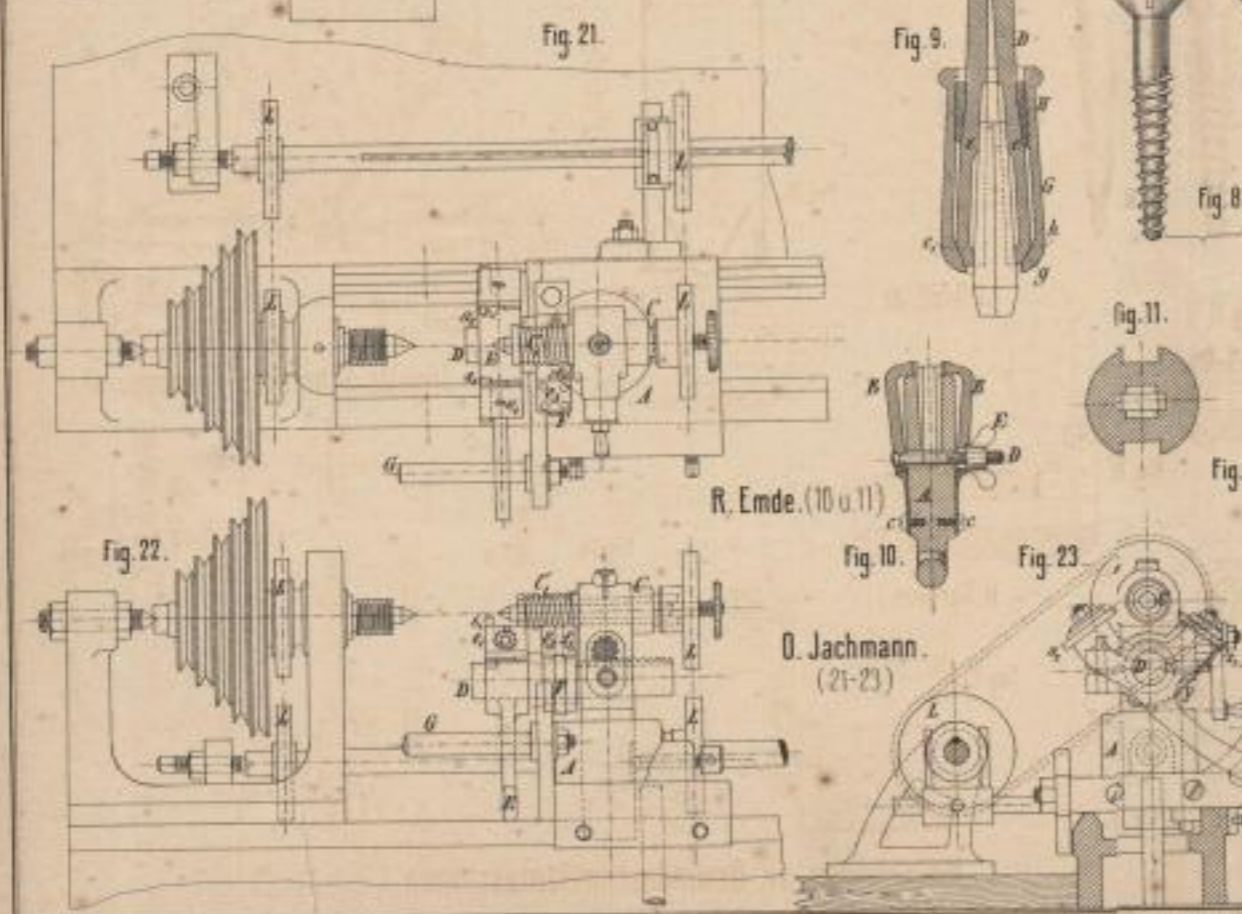
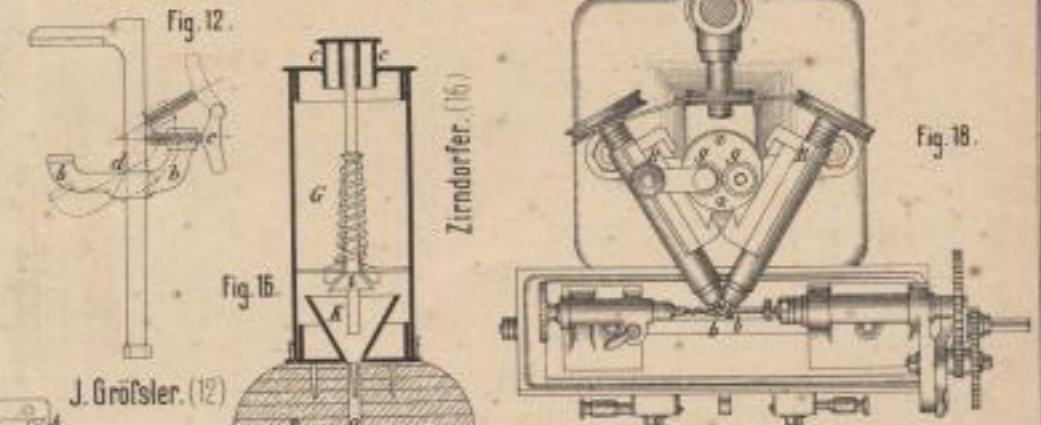

Neuerungen an Gewindeschneidmaschinen. (19 u 20, 21-23)

Verlag von J. Neumann, Neudamm.

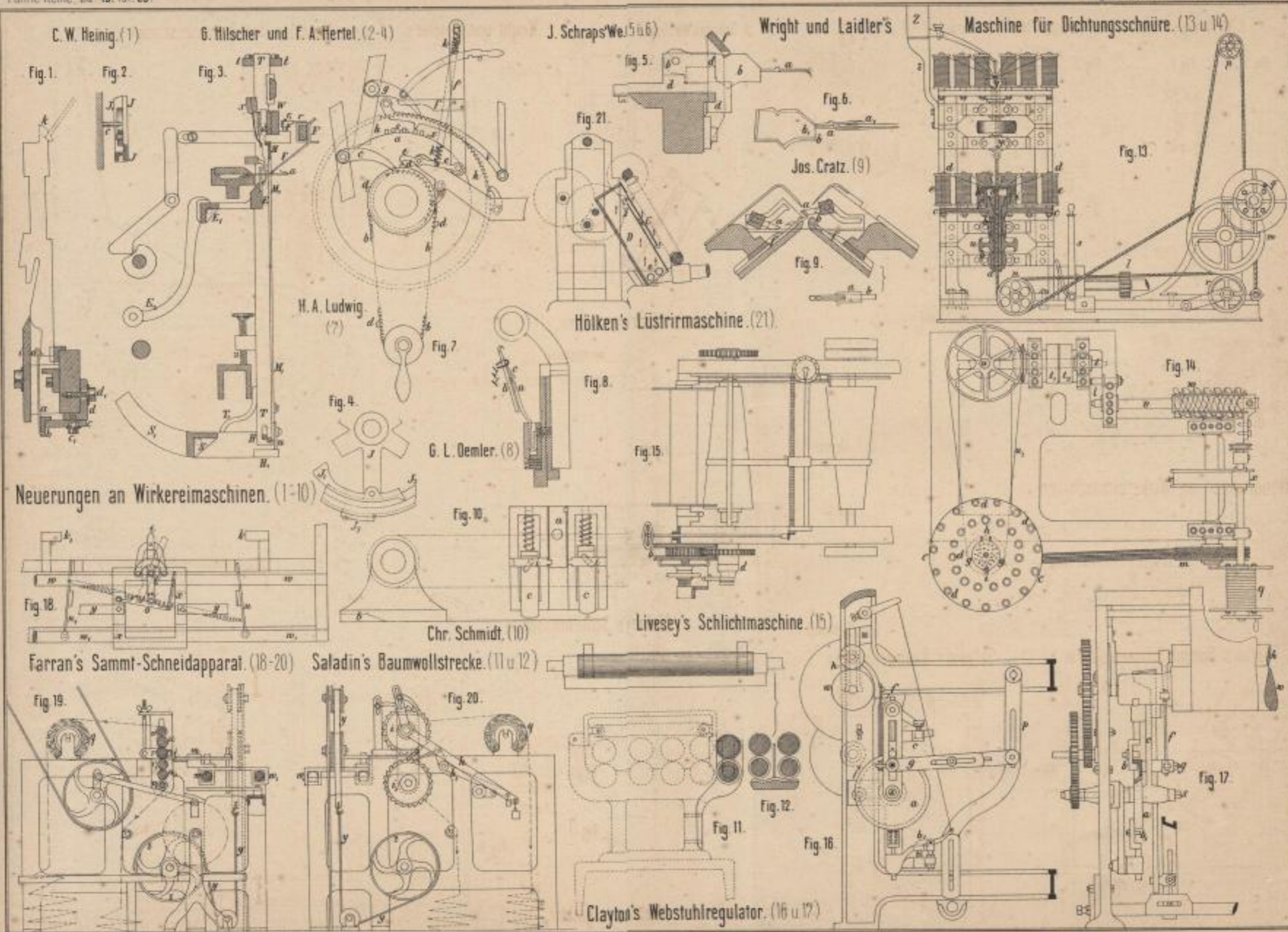

Lith. Anstalt v. F. W. v. ...

Lütrig's Wasserkläranlage für Kohlenwäschen. (10 u. 11)

Reifsfeder. (13)

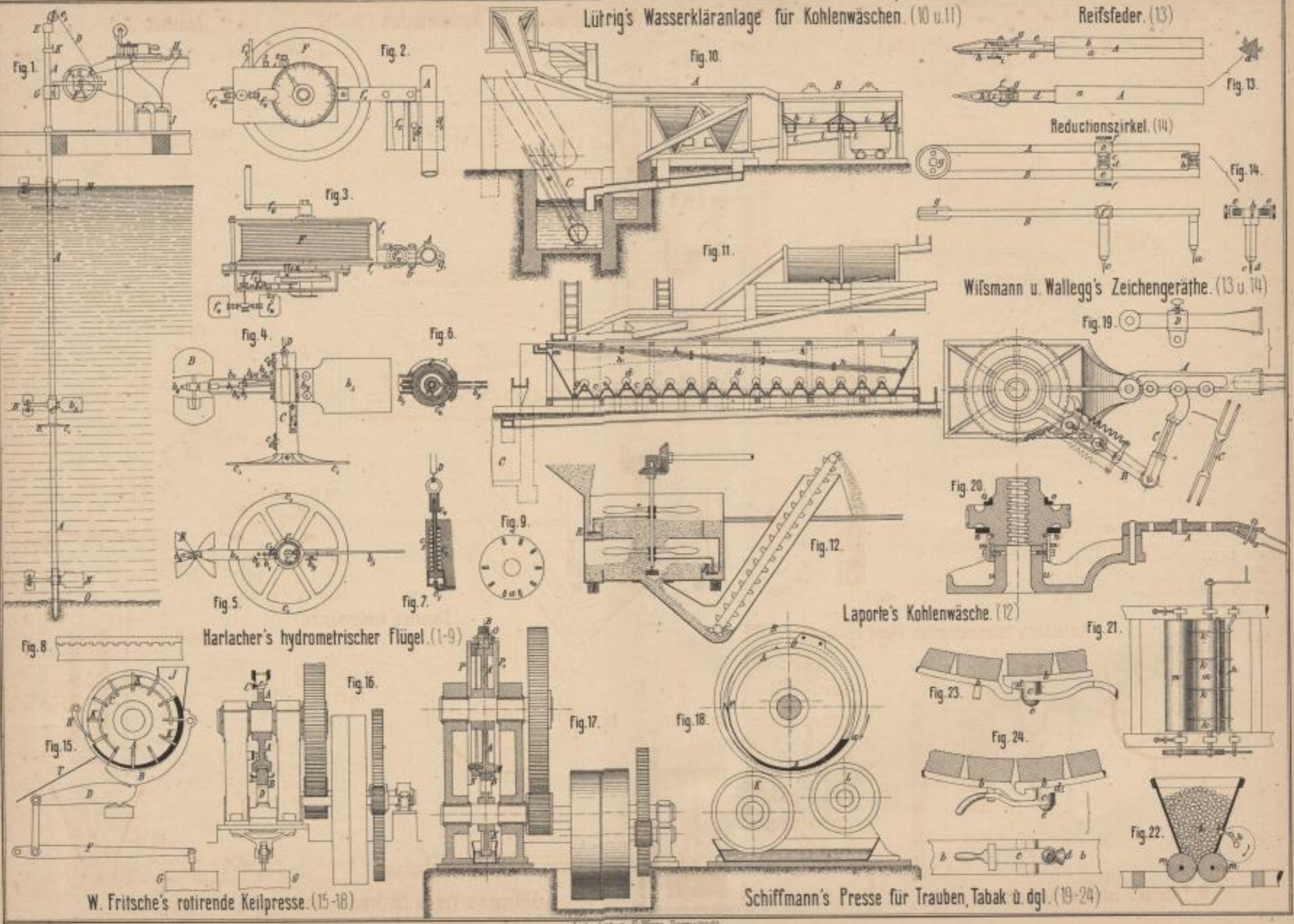

Harlacher's hydrometrischer Flügel. (1-9)

Wißmann u. Wallegg's Zeichengeräthe. (13 u. 14)

Laporte's Kohlenwäsche. (12)

W. Fritsche's rotirende Keilpresse. (15-18)

Schiffmann's Presse für Trauben, Tabak ù dgl. (19-24)

Lith. Anst. v. F. Wenz, Darmstadt.

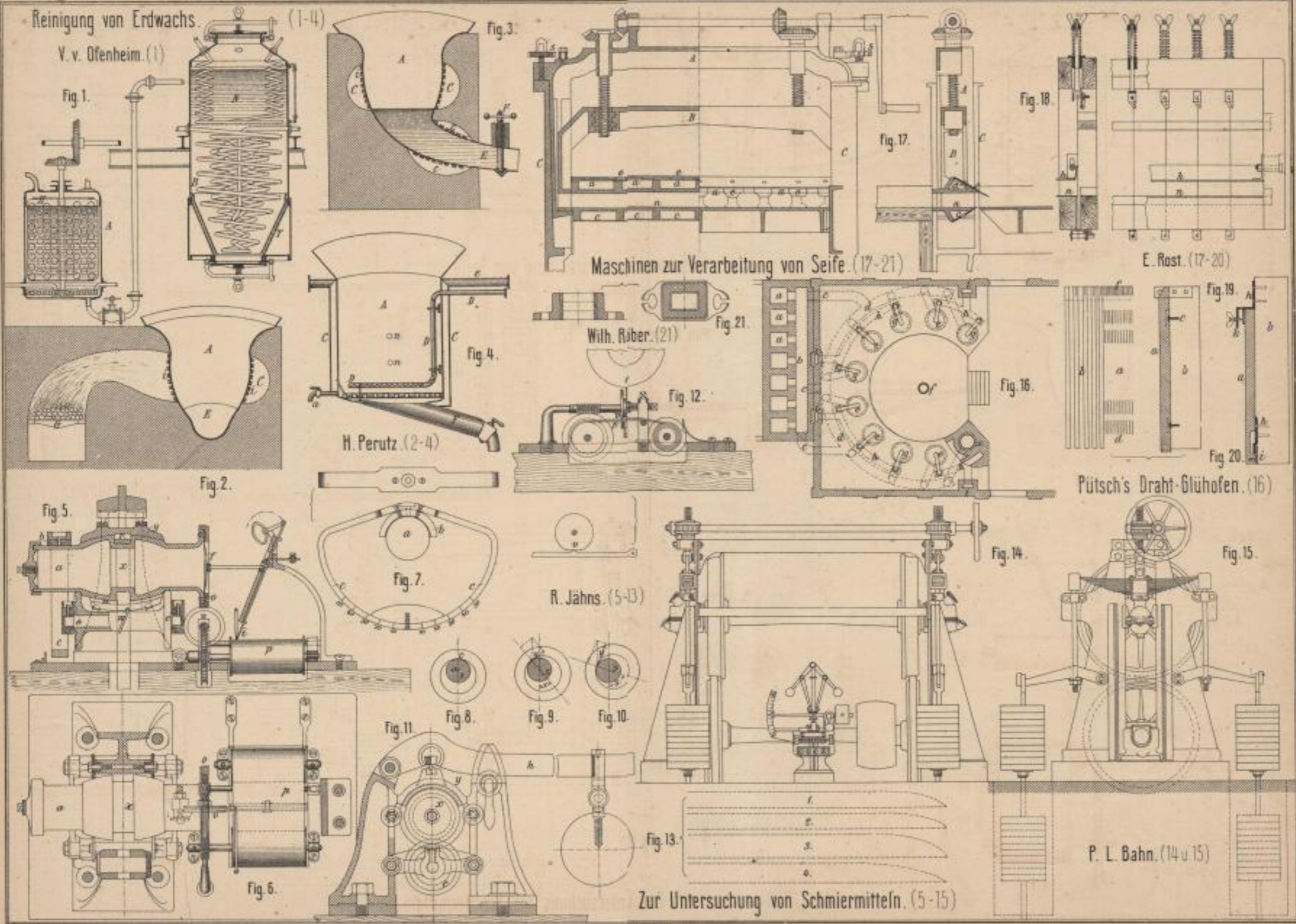

Verf. nach P. Wetz, Darmstadt



Kley's Wasserhaltungsmaschine mit Rotation und Hubpausen. (1-10)

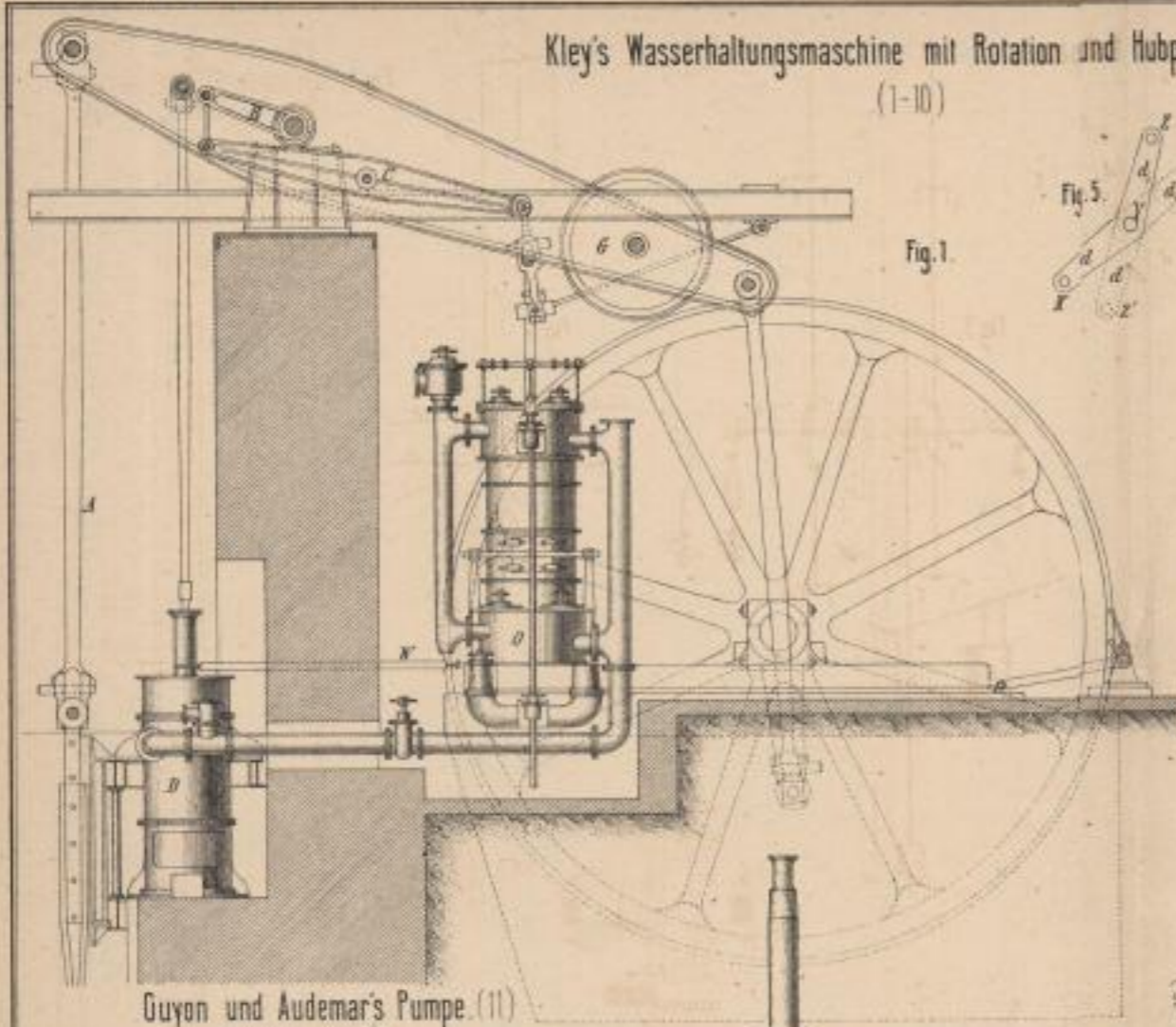

Fig. 1



Fig. 5

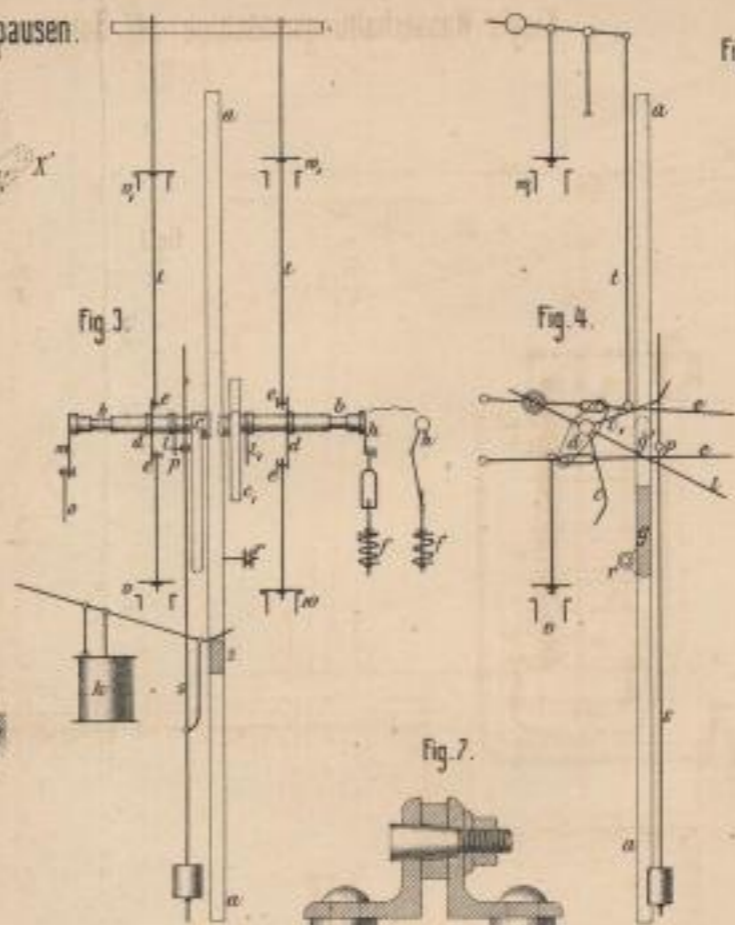

Fig. 3

Fig. 4

Fig. 7



Fig. 8

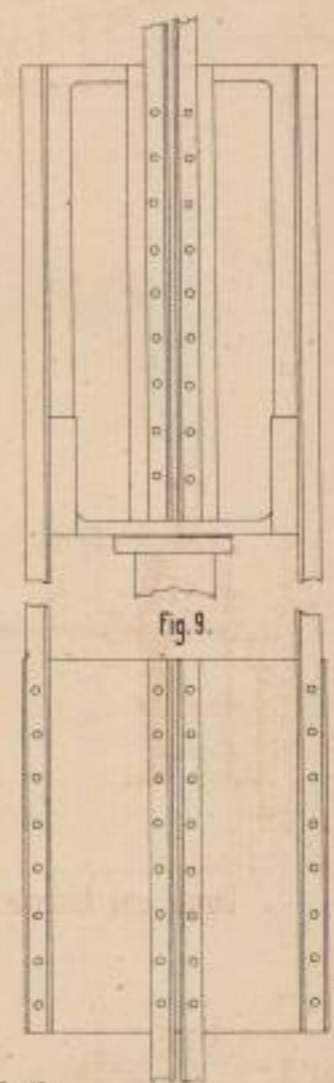

Fig. 9

Fig. 10

Guyon und Audemar's Pumpe (11)

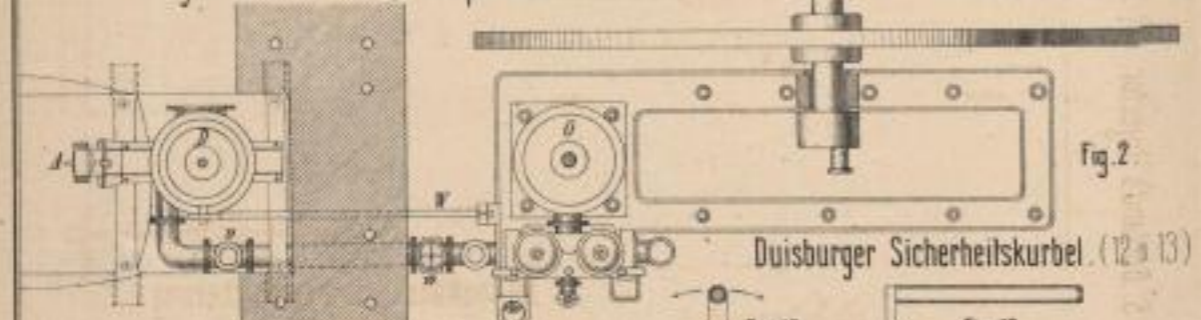

Fig. 2

Fig. 11

Duisburger Sicherheitskurbel (12-13)

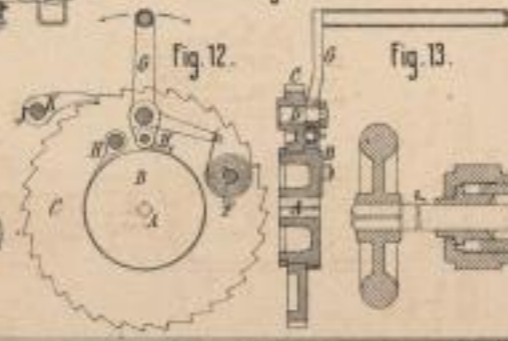

Fig. 12

Fig. 13

S. Borland's Injector. (14 u 15)

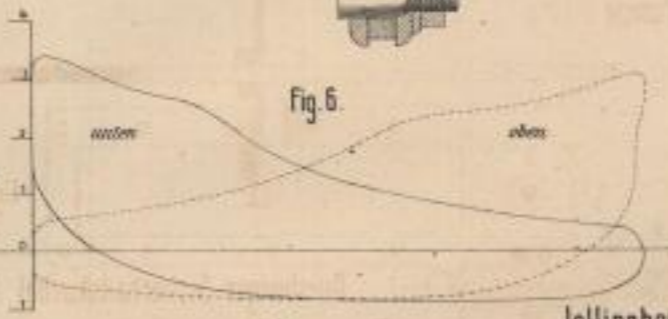

Fig. 6

Fig. 14

Fig. 15

Jellinghaus' Schraubensicherung (16-18)

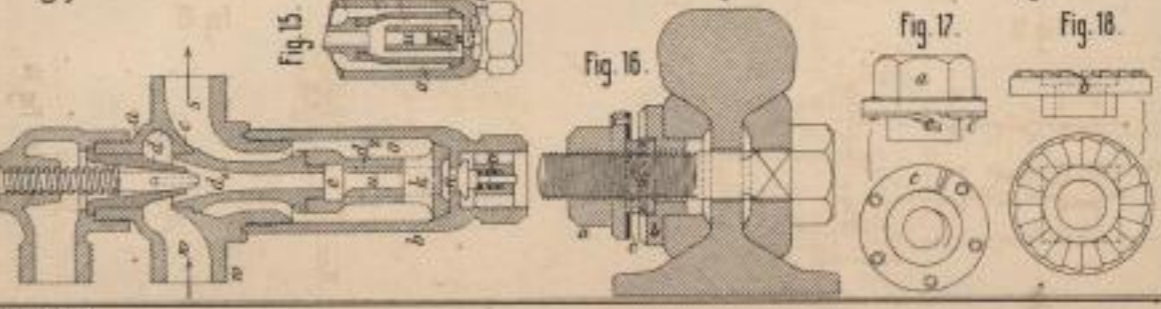

Fig. 16

Fig. 17

Fig. 18

Lab. Ausz. v. P. Wirtz, Darmstadt



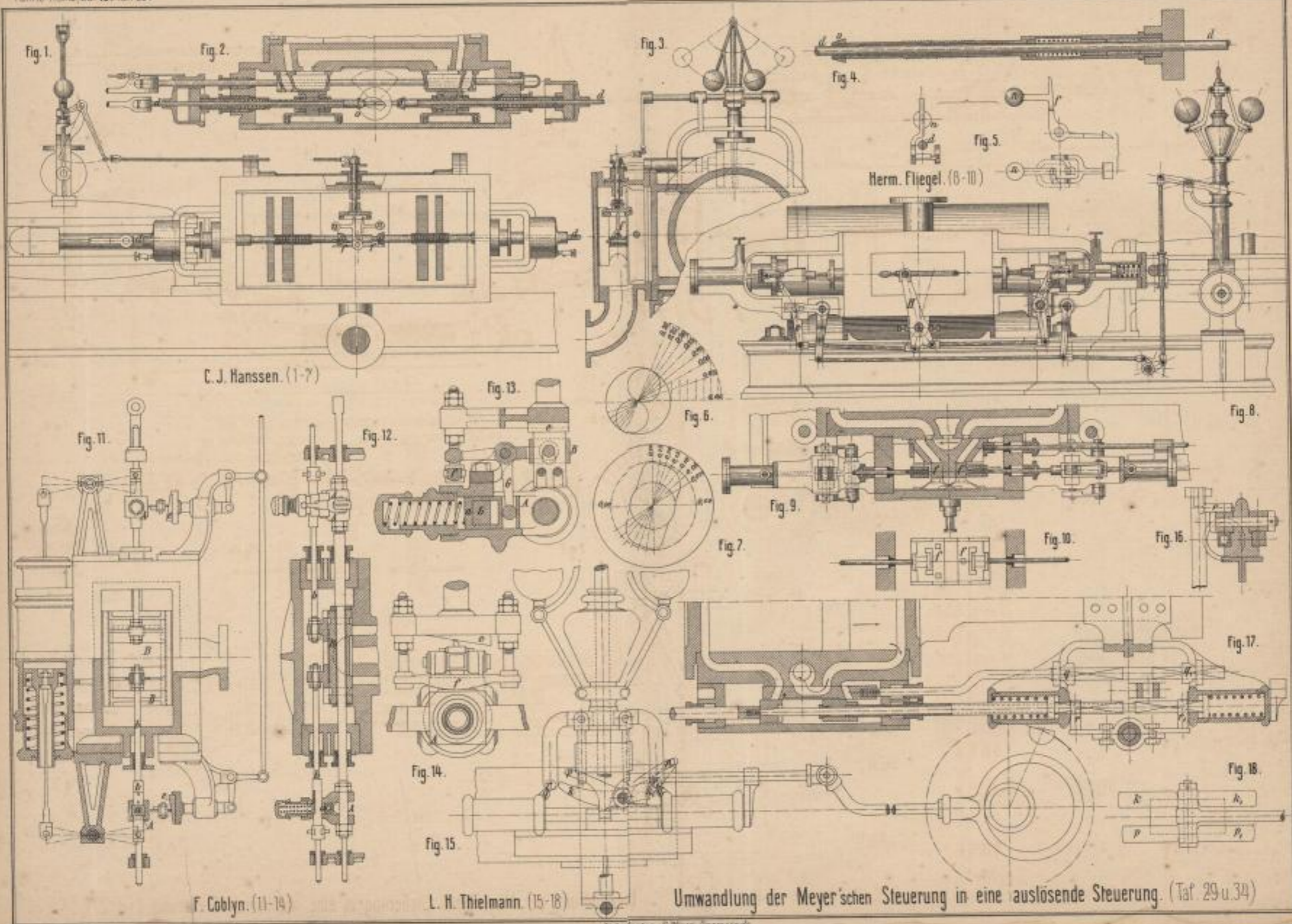

C. J. Hanssen. (1-7)

F. Cobllyn. (11-14)

L. H. Thielmann. (15-18)

Umwandlung der Meyer'schen Steuerung in eine auslösende Steuerung. (Taf. 29 u. 34)

Verf. Inst. v. J. W. v. W. v. W. v. W.



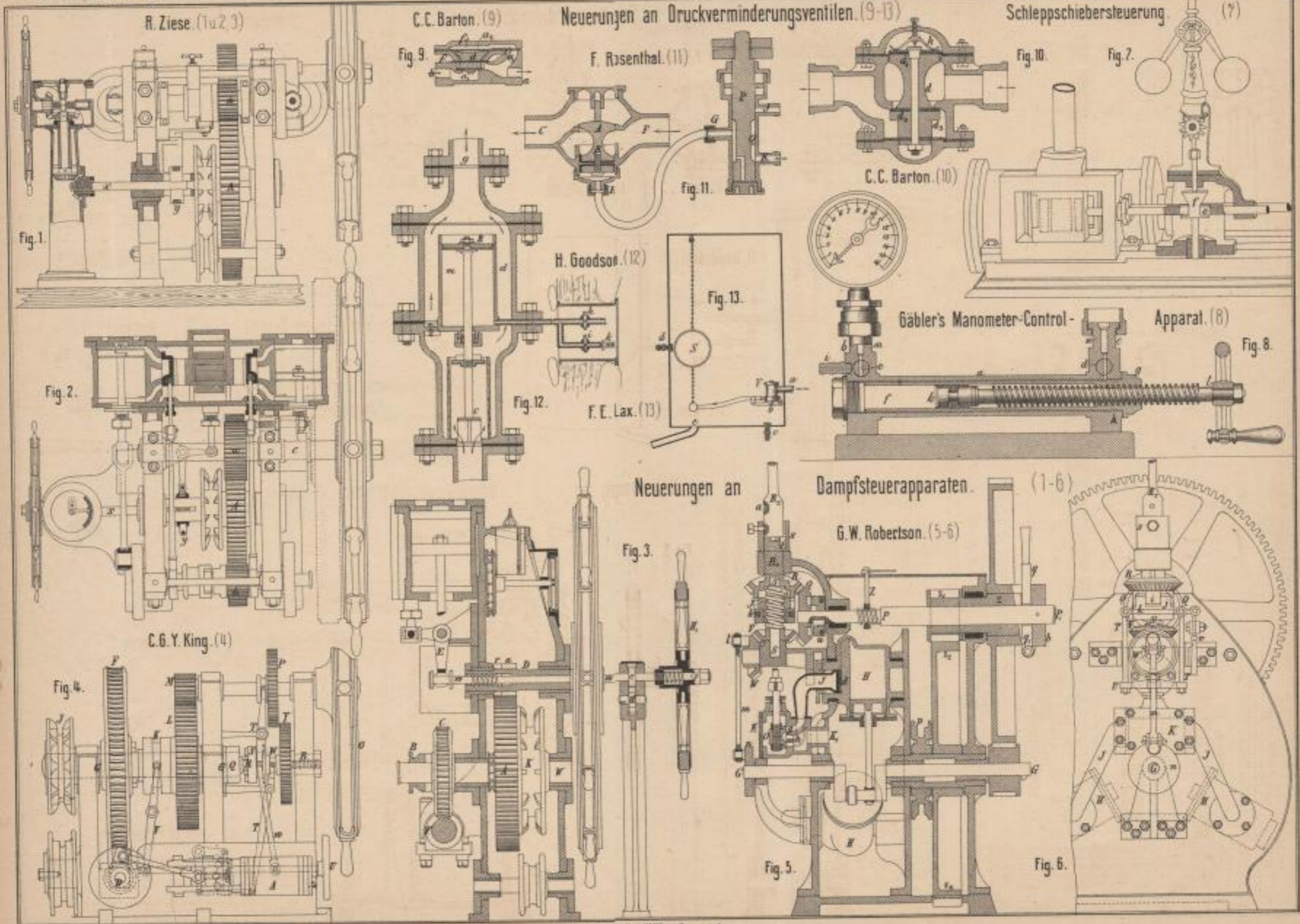

Tab. Anstalt v. F. Wiese, Darmstadt.

Nuß's Aufspannapparat für Radreifen-Befestigungsringe. (1-7.)

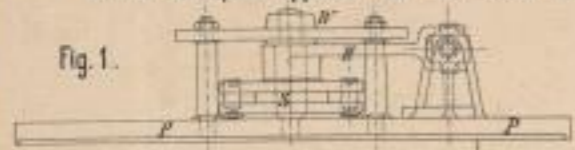

Fig. 1.

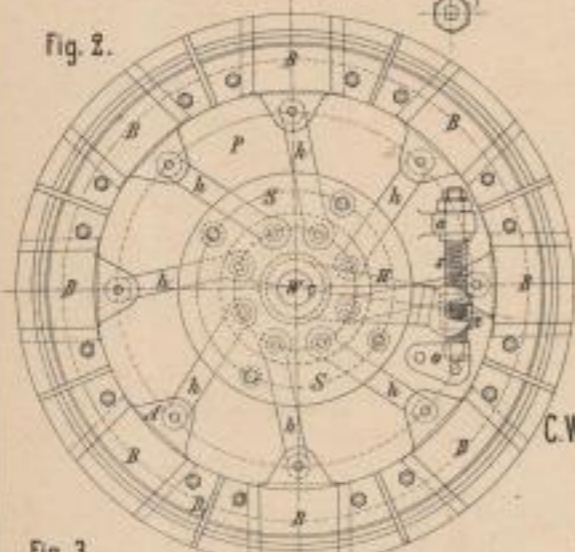

Fig. 2.



Fig. 3.

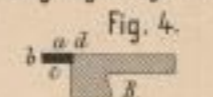

Fig. 4.



Fig. 5.



Fig. 6.

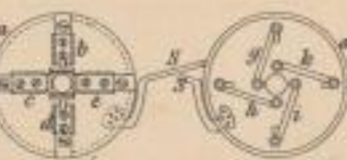

Fig. 7.



Fig. 8.

C.W. Fuchs' Maschine für Holznägel. (8 u. 9.)

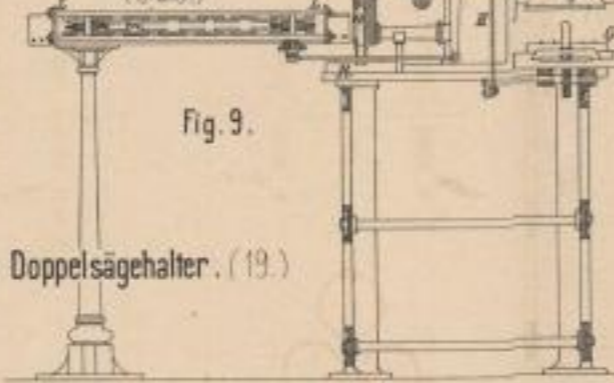

Fig. 9.

H.v. Hofstle's Walzen-Riffelapparat. (20-23.)

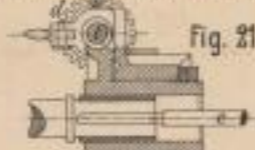

Fig. 21.

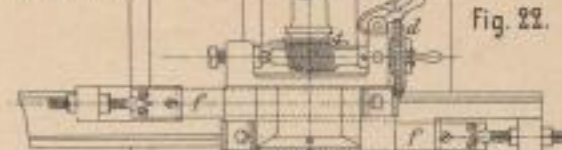

Fig. 22.



Fig. 23.

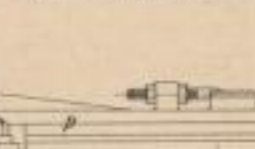

Fig. 24.



Fig. 25.

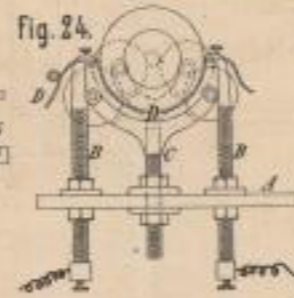

Fig. 26.

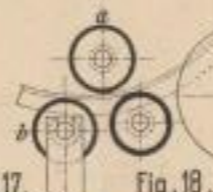

Fig. 27.

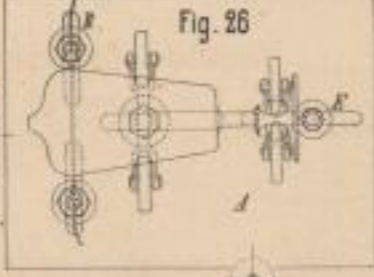

Fig. 28.

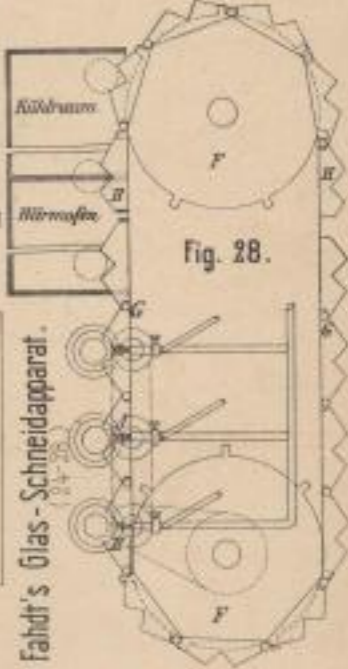

Fig. 29.

Fahdt's Glas-Schneidapparat.

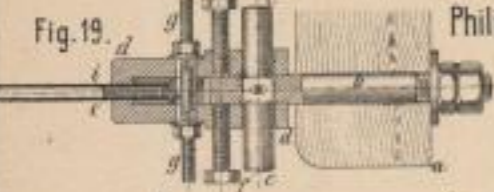
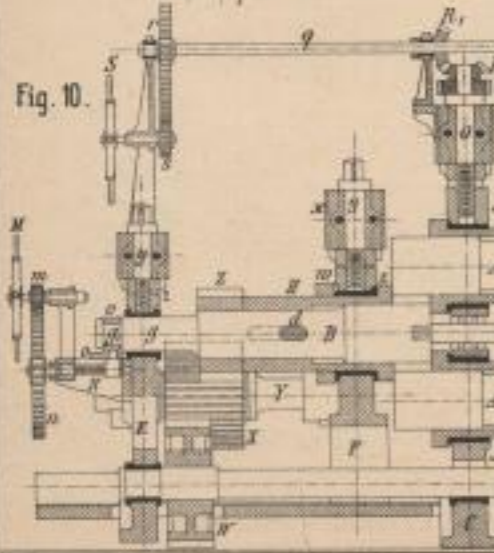

Fig. 10.

Philipsthal's Doppelsägehalter. (19.)



Stauch's Reifenbiegmaschine. (16-18.)

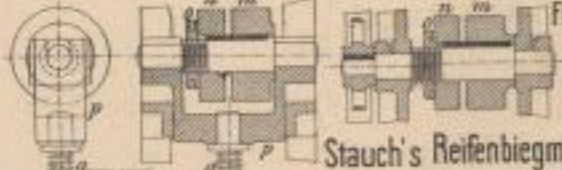

Fig. 12.



Fig. 13.



Fig. 14.



Ed. Daelen's Universalwalzwerk. (10-15.)

Lith. Anst. v. F. Metz, Darmstadt.



Neuerungen an Letternsetz und Ablegemaschinen. (Taf. 32 u. 37)

Karl Eisele (3-6)

Friedr. Wicks. (7-9) (Vgl. Fig. 4-7 Taf. 37)

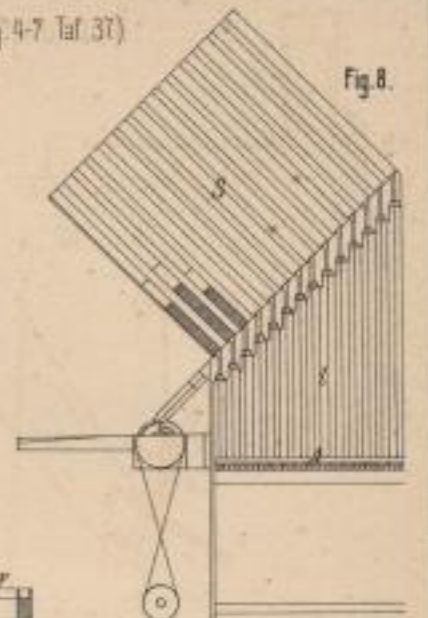
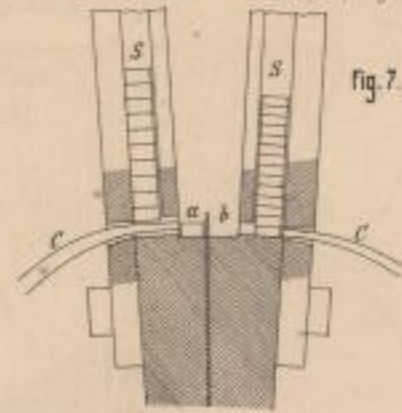
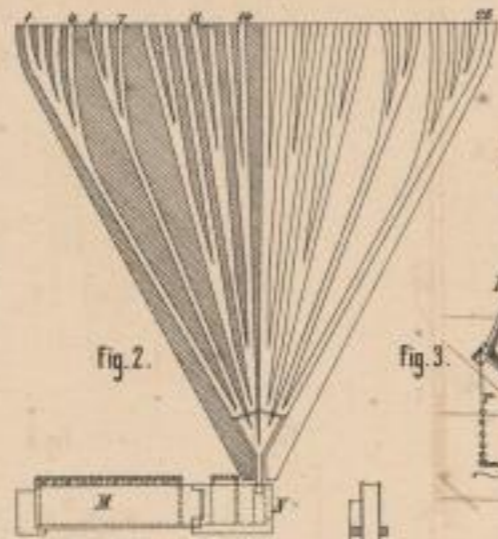
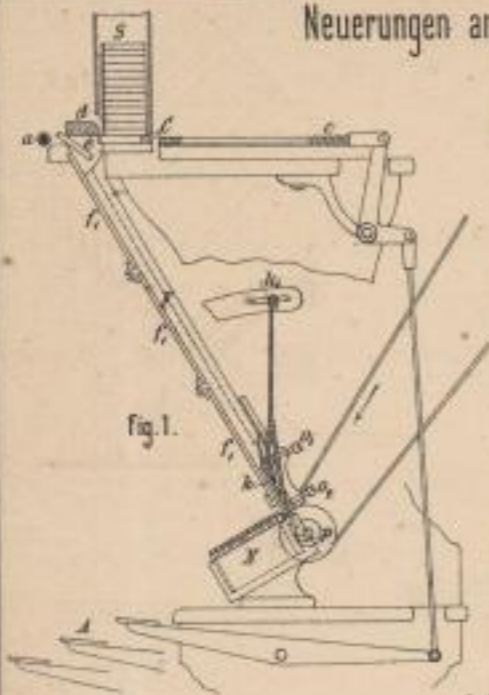

S. W. Green. (1 u. 2)

I. Prasch. (10-12)
(Vergl. Fig. 1 Taf. 37)

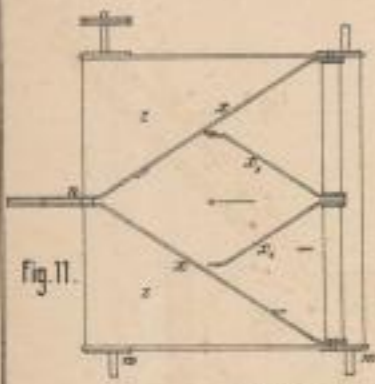
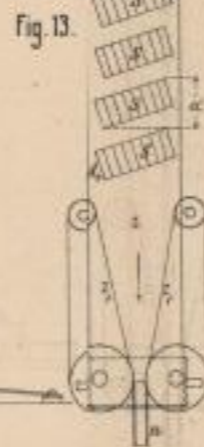
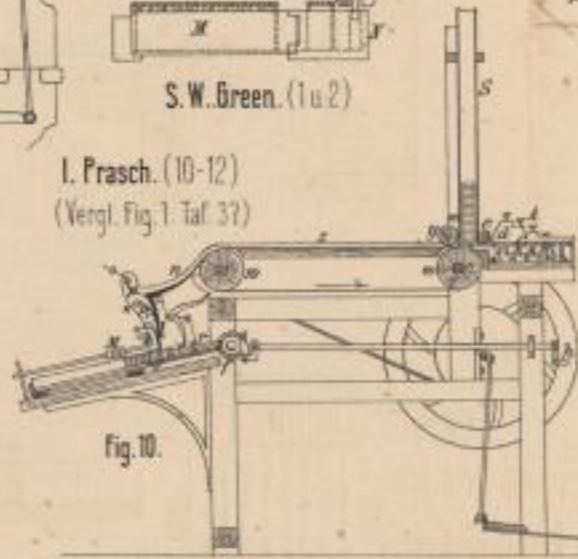

Fig. 10.

Fig. 13.

Fig. 14.

Fig. 9.

K. G. Fischer und Alf. v. Langen. (13-19) (Vgl. Fig. 2 u. 3 Taf. 37)

Jos. Thorne. (20 u. 21)

Friedr. Wicks. (22-24) (Vgl. Fig. 4-7 Taf. 37)

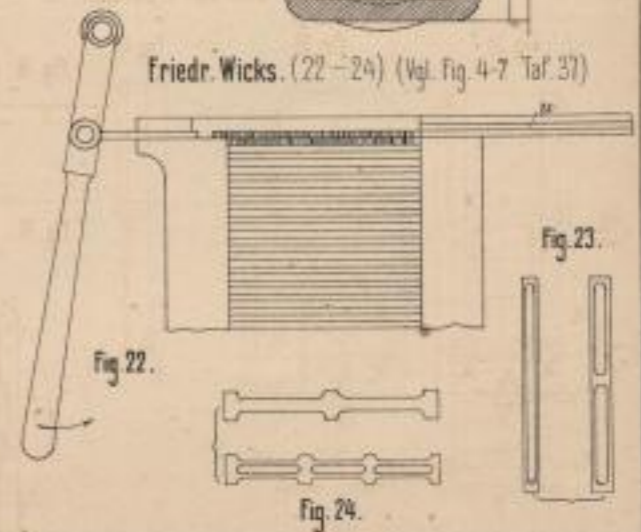
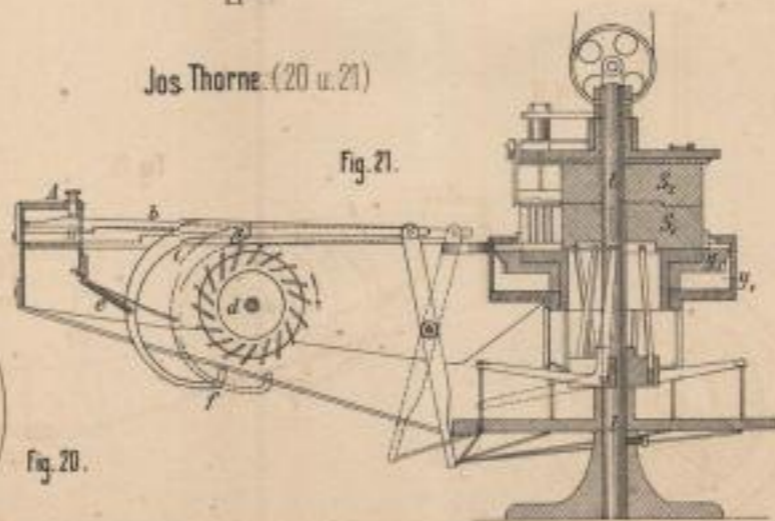
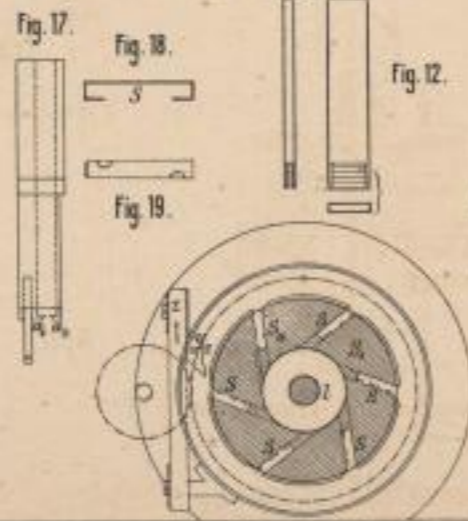
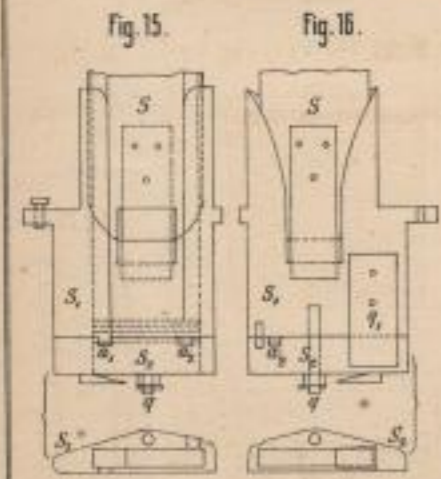

Lab. Anst. v. J. Wirtz, Darmstadt.

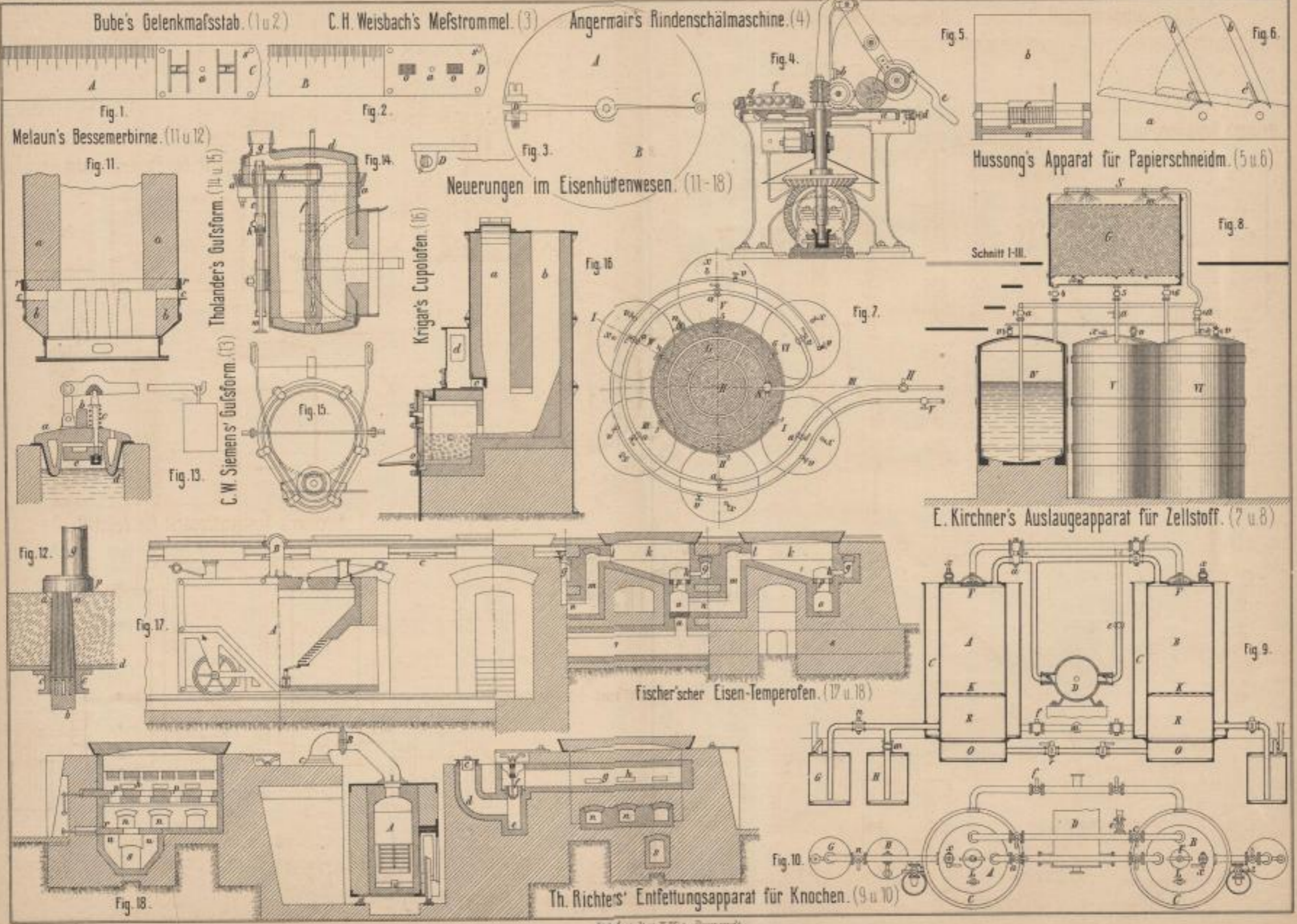

Isch. Anstalt. v. F. W. W. Darmstadt.

Gutehoffnungshütte in Oberhausen II.

(1-4)

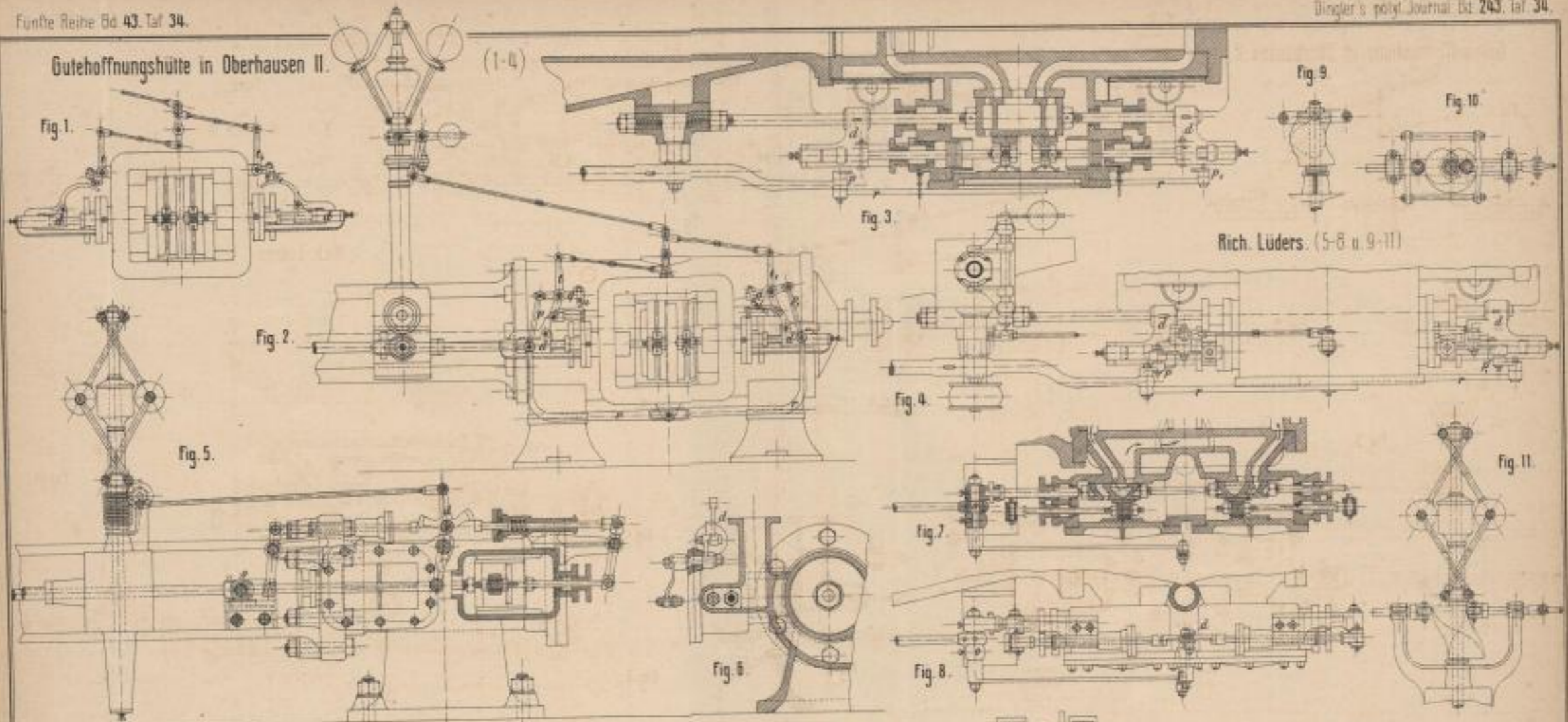

Rich. Lüders. (5-8 u. 9-11)

Umwandlung der Meyer'schen Steuerung in eine auslösende Steuerung. (Taf. 29 u. 34)

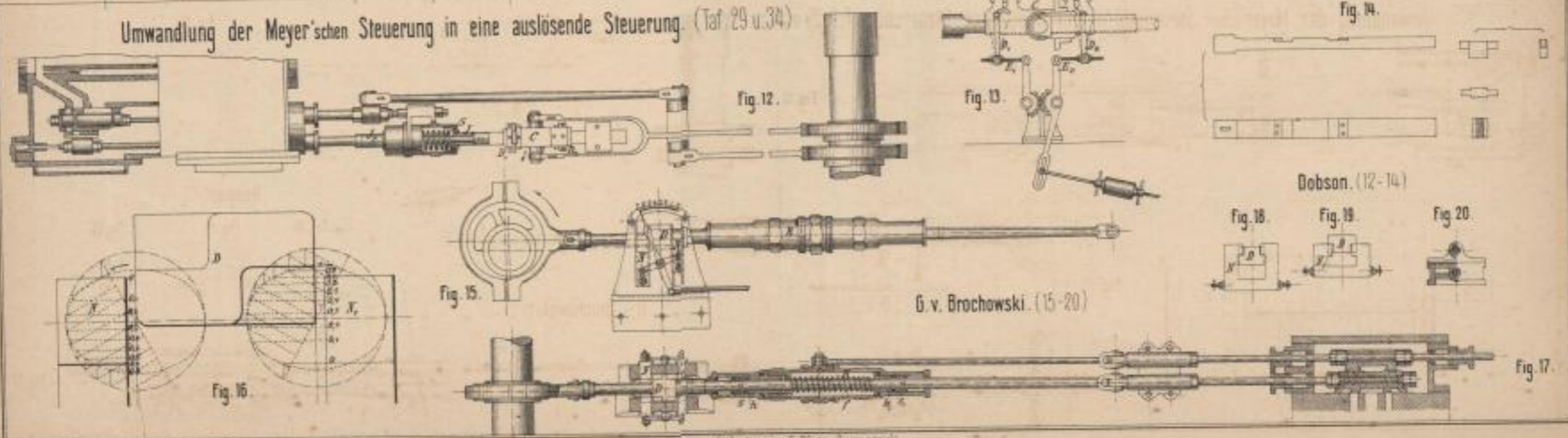

Dobson. (12-14)

G. v. Brochowski. (15-20)

Lehr. Inst. v. F. Wenz. Darmstadt

C. Bach: Ueber Wasserabscheider. (1-7)

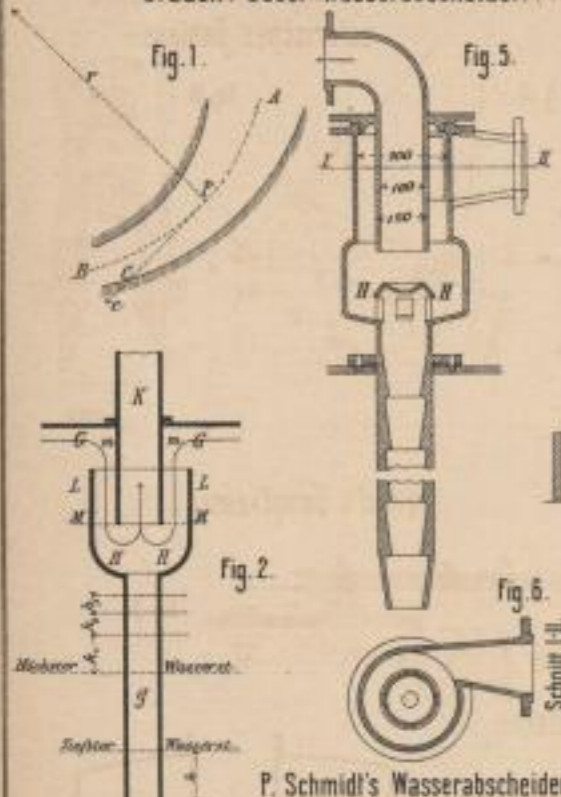

P. Schmid's Wasserabscheider. (7)

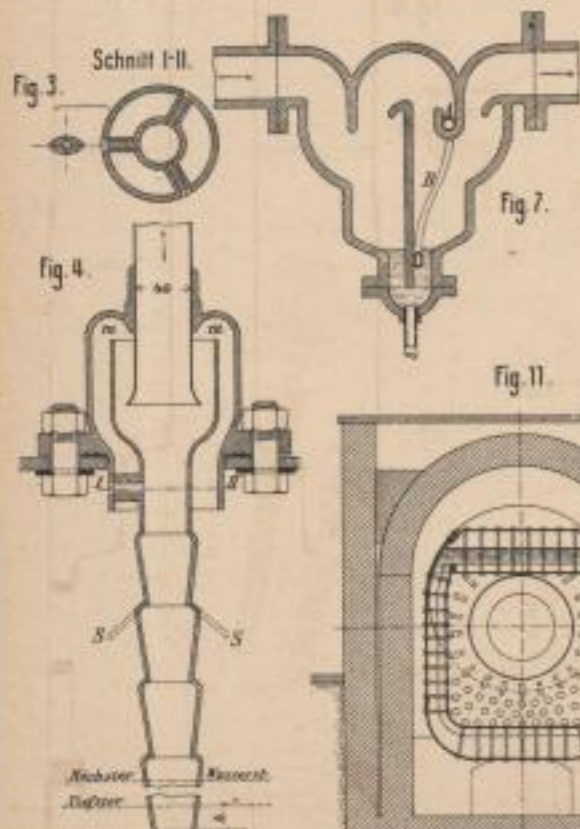

Bräunert's Ventilkasten

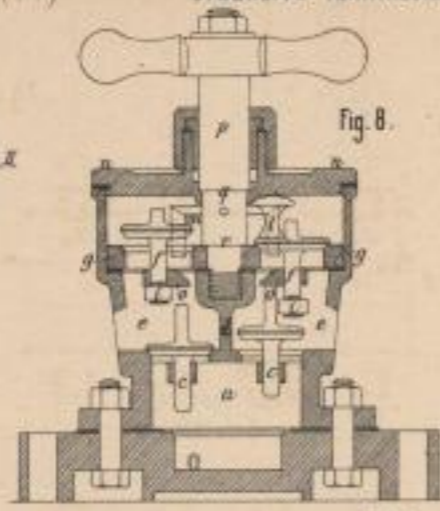

für Feuerspritzen. (8)

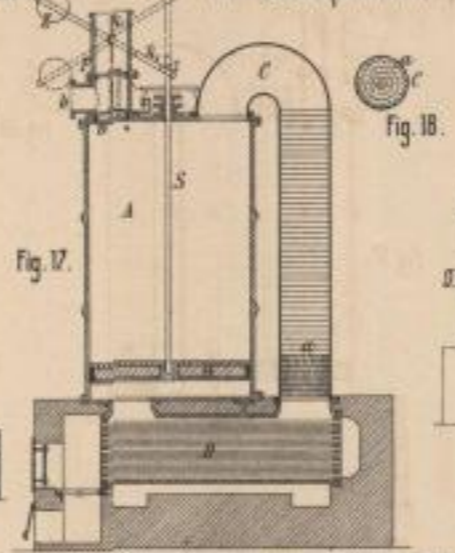

Jagn und Cohnfeld's calorisches Gebläse. (17-20)

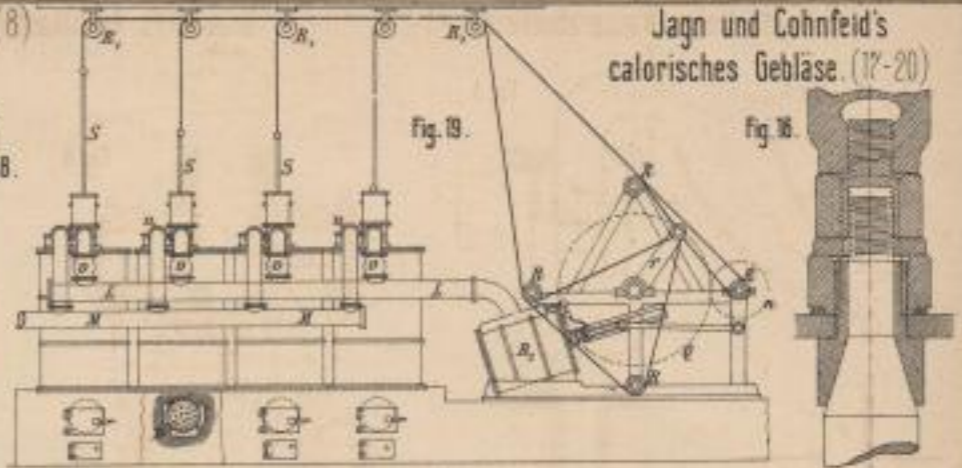

Ballauf's Dampfkessel. (15 u 16)

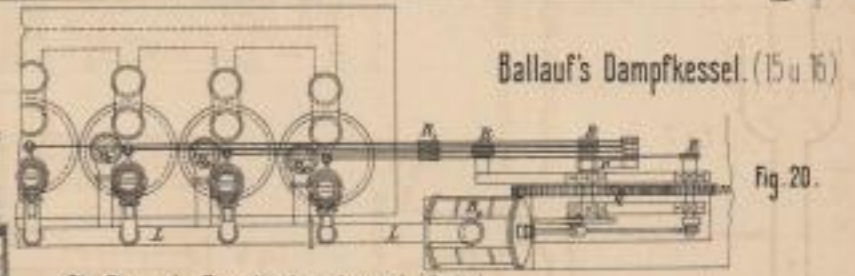

Ch. Brown's Rauchröhrenkessel. (9-14)

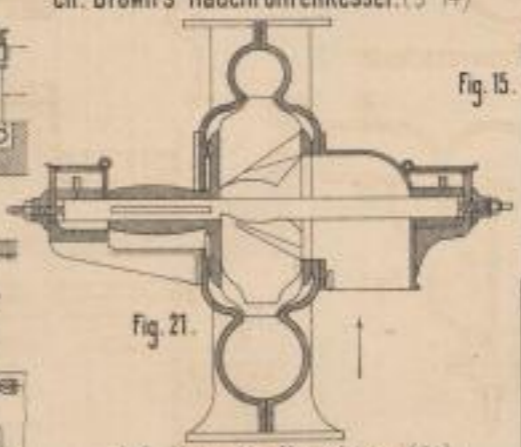
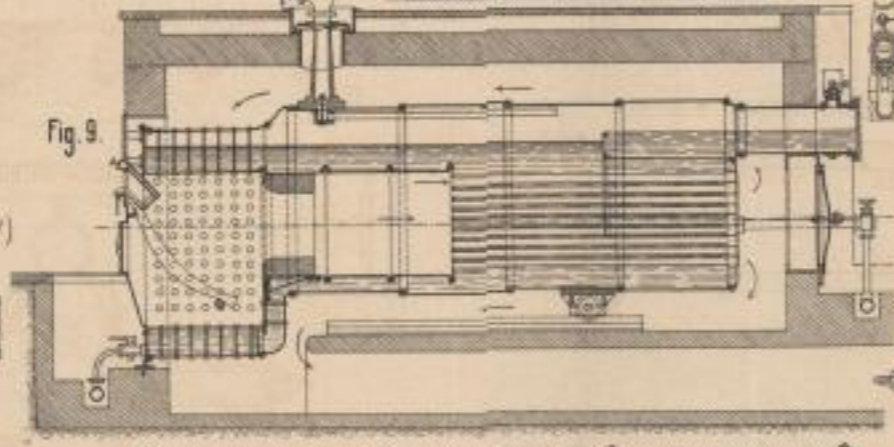

J. C. Kämpf's Ventilator. (21)

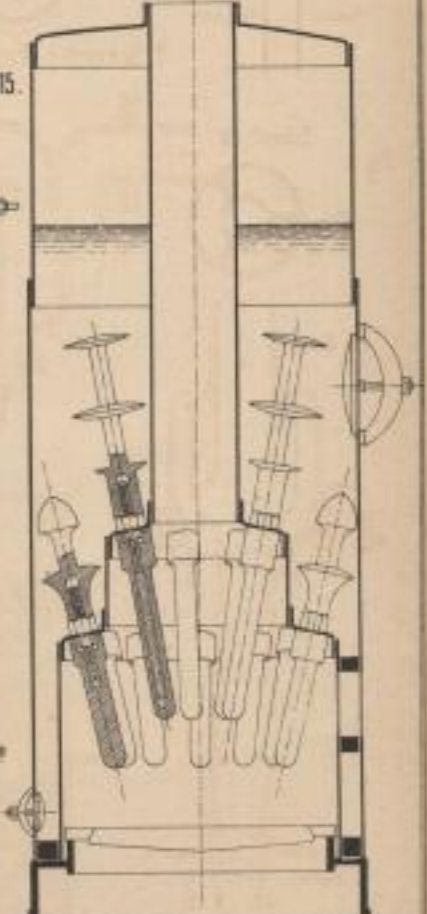
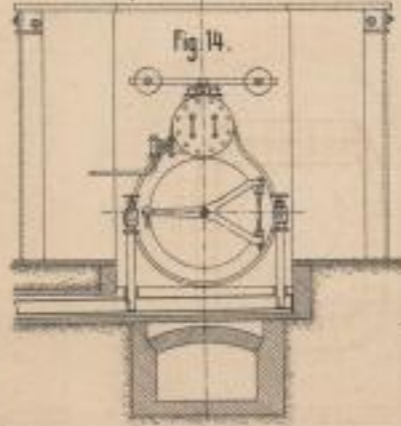
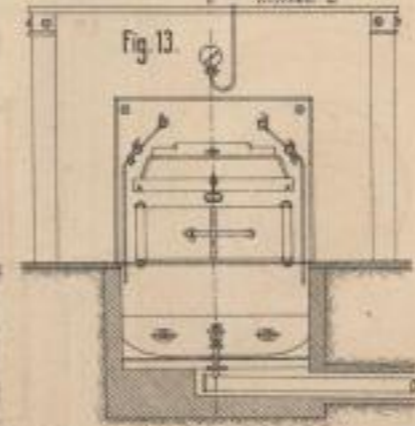
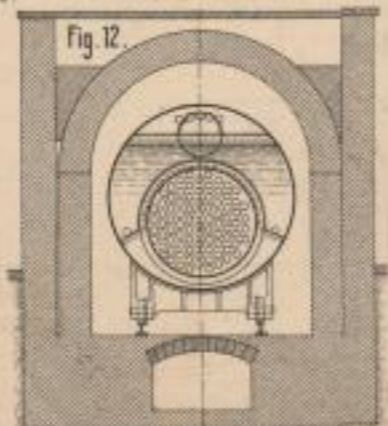
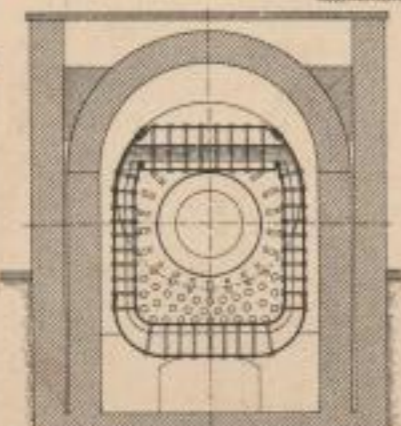

Lith. Anst. v. P. W. W. J. Bernhardt.

Esser's Maschine für Kessel- und Feuerbüchsplatten. (1-4)

Laißle's Doppelformmaschine. (12-14)

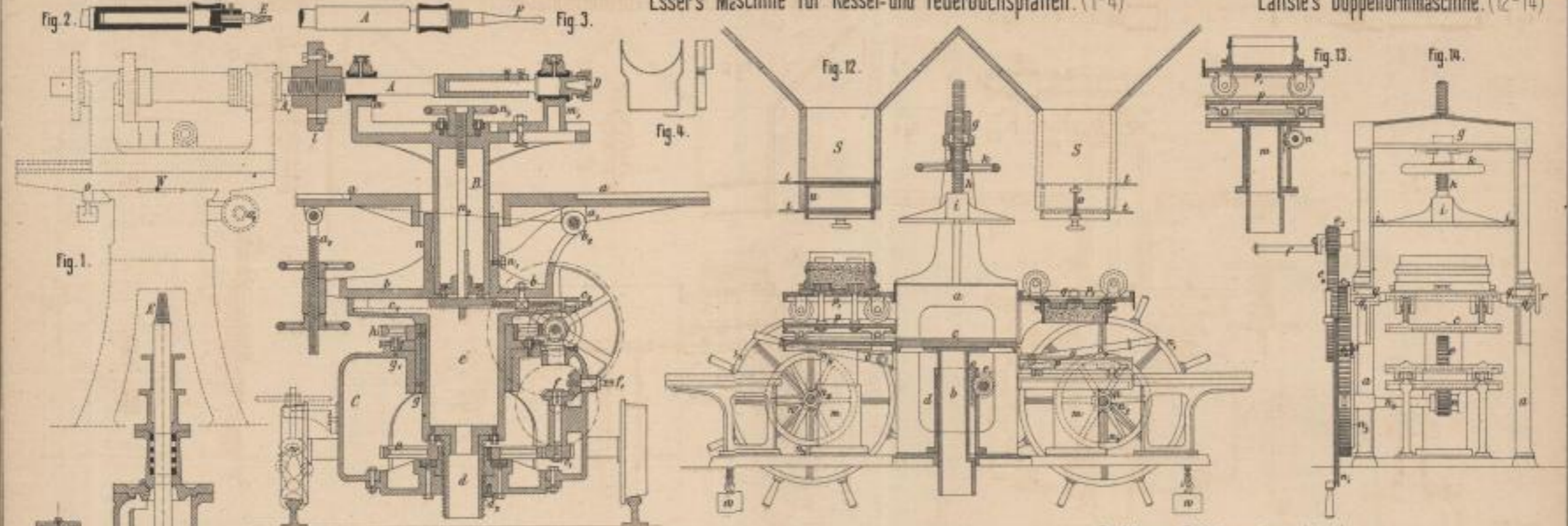

Derlikoner Riffelmaschine. (7-11)

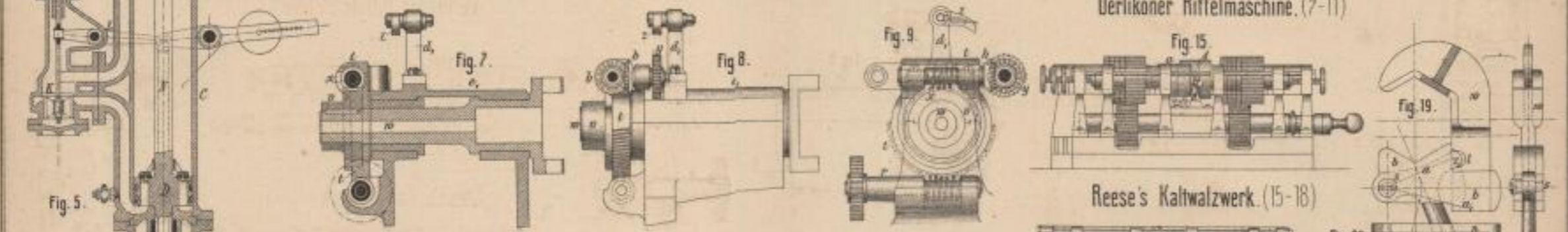

Reese's Kaltwalzwerk. (15-18)

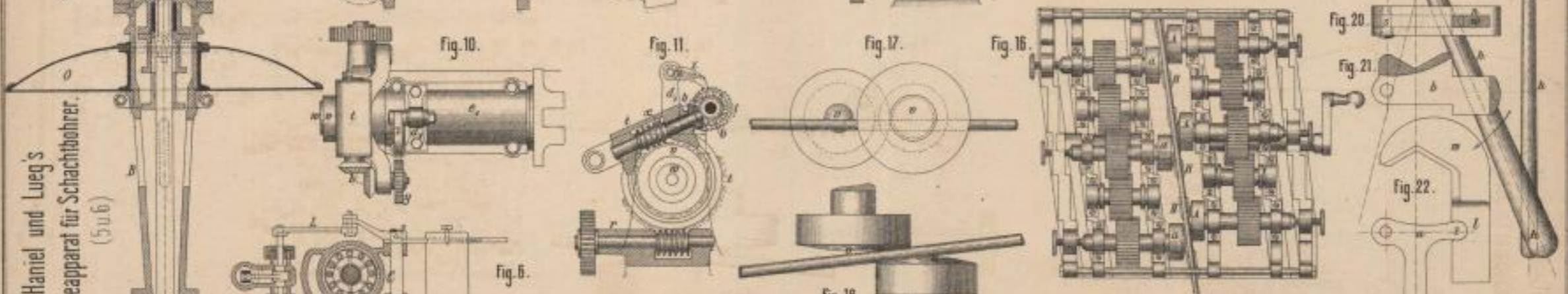

Oldenburger's Schraubenschlüssel. (19-22)

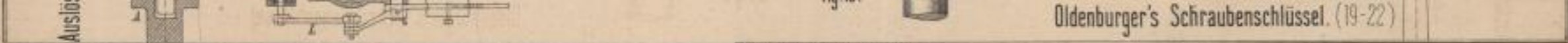

Haniel und Lueg's Auslöseapparat für Schachtbohrer. (5 u. 6)

Lith. Anst. v. F. Wenz, Darmstadt.

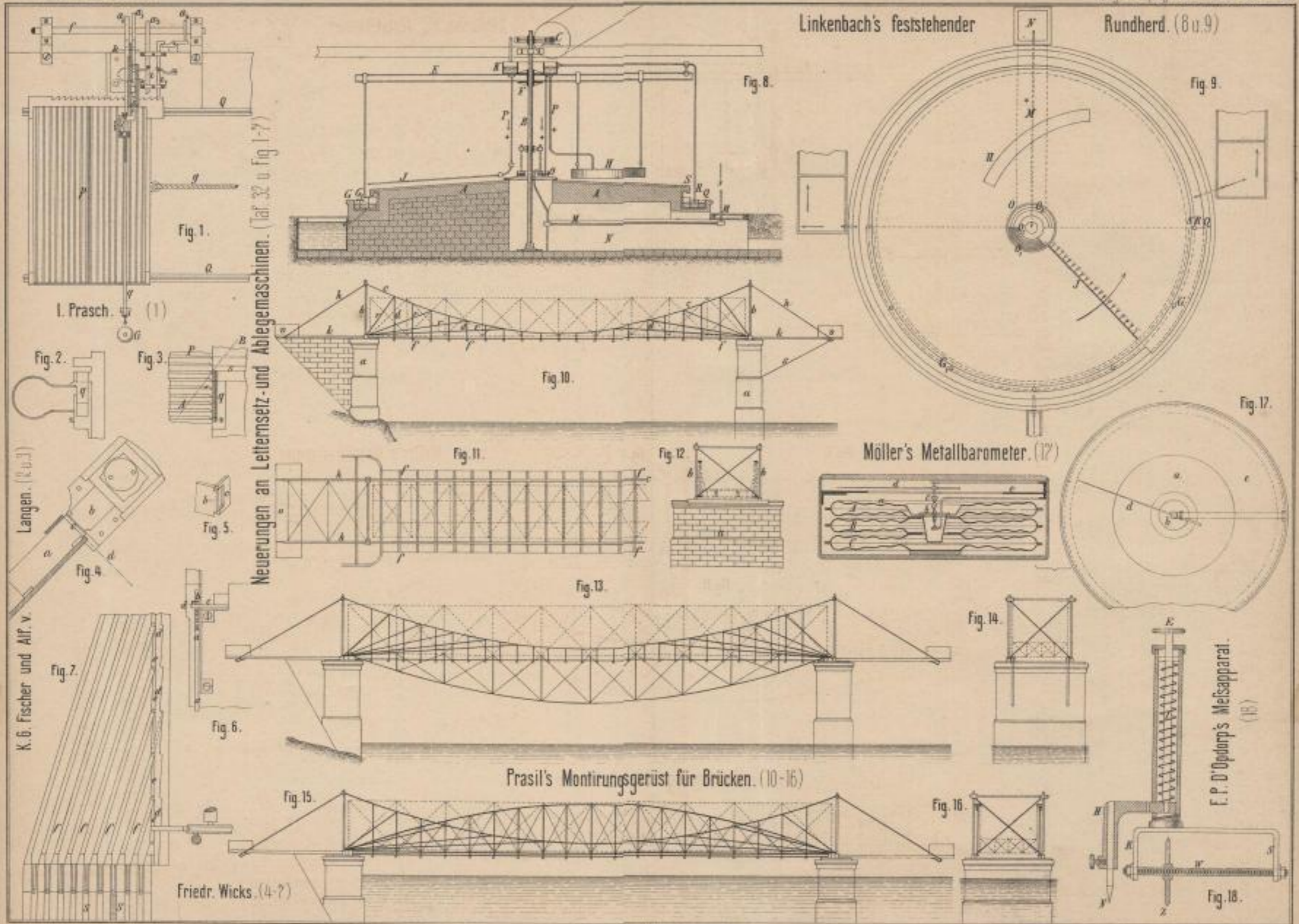

Neuerungen an Leitensez- und Ablegemaschinen. (Taf. 32 u. Fig. 1-7)

Linkenbach's feststehender

Rundherd. (8 u. 9)

Möller's Metallbarometer. (17)

Prasil's Montirungsgerüst für Brücken. (10-16)

F. P. D'Opdorp's Meissapparat. (18)

Friedr. Wicks. (4-7)

Lith. Anst. v. F. Wirtz, Darmstadt



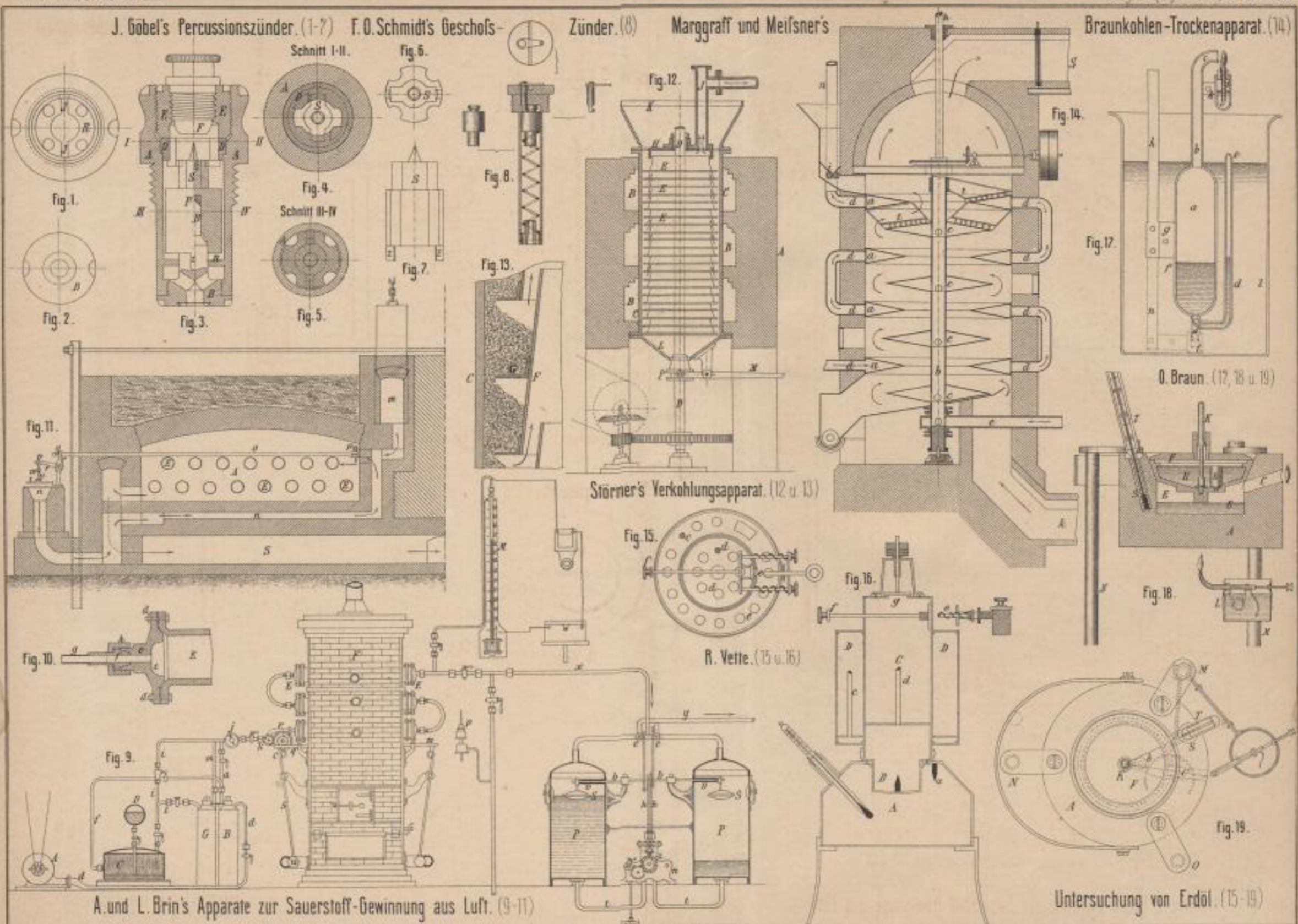

Lith. Anst. v. F. W. v. Schwanen

Sächs.
Landes-
Bibl

1785
Landesbibliothek
Dresden

Einzelblätter
Buchbinder
DRESDEN

Technik 1864

SLUB DRESDEN



3 2422835