

M. Honigmann's Natrienlocomotive. (1-4)

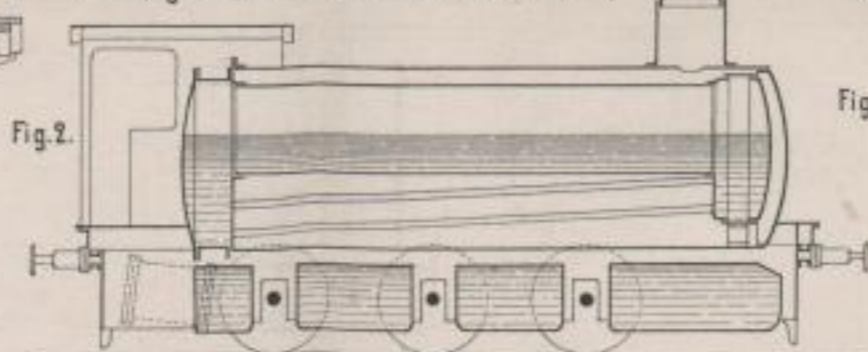

A. Bell und A. Fuller. (14)

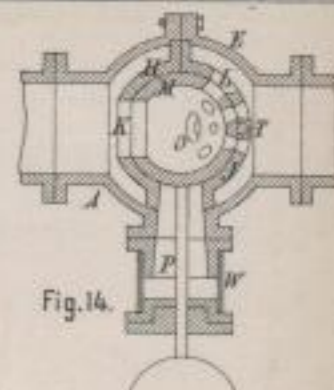
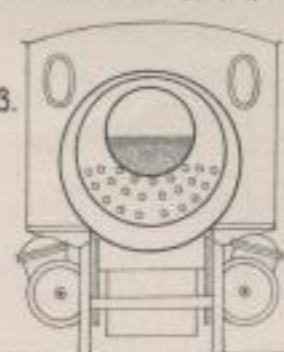

Neuerungen an Regulatoren. (14-18)

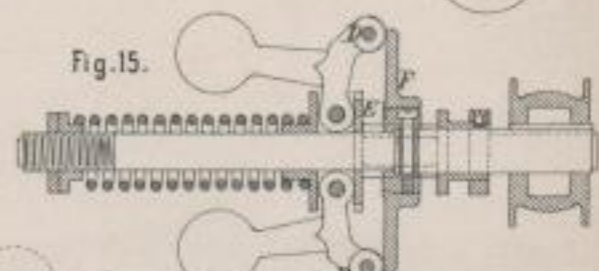

J. Buckett's Hilfsluftmaschine. (5-13)

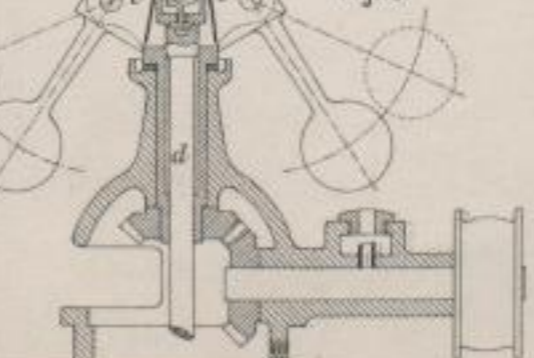
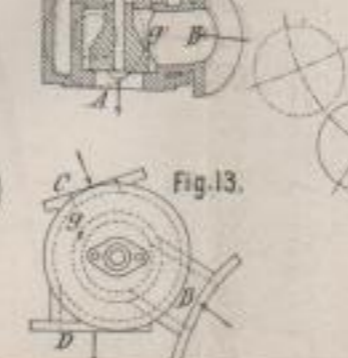
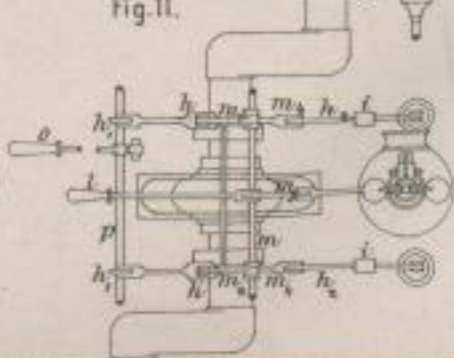
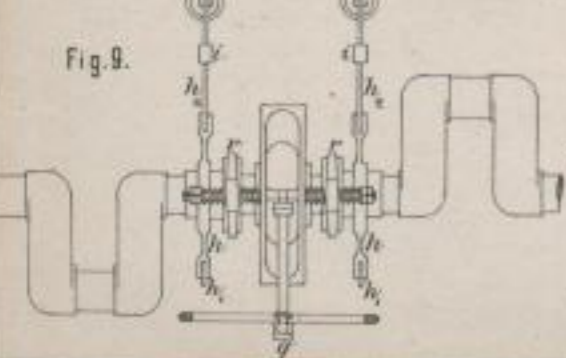
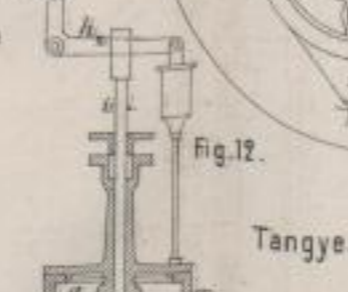
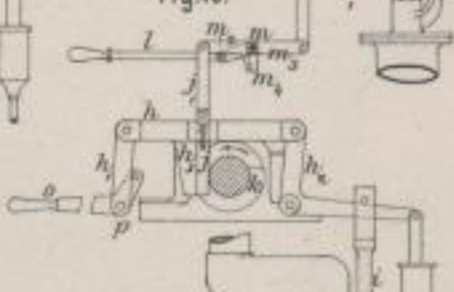
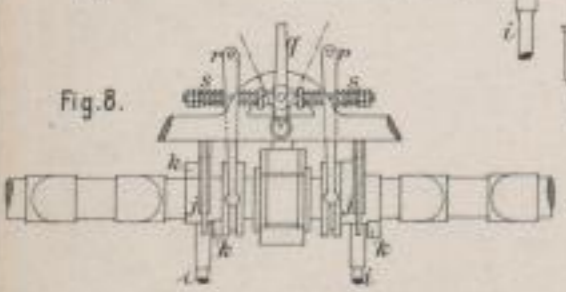
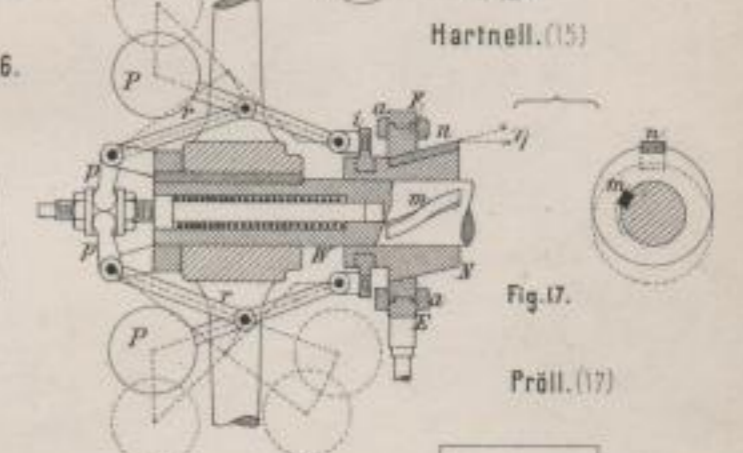
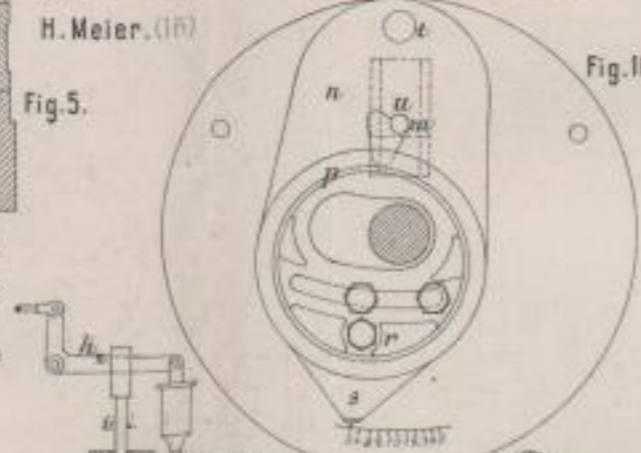
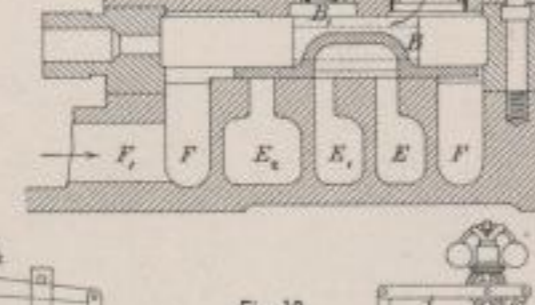
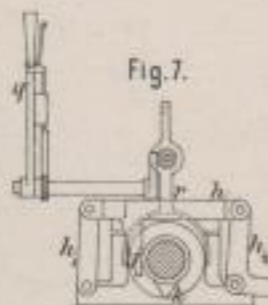

Lith. Anst. v. J. Wirtz. Darmstadt