

Neuere Brenner mit Vorwärmung der Verbrennungsluft (Taf. 25 u. Taf. 27 Fig. 1-8)

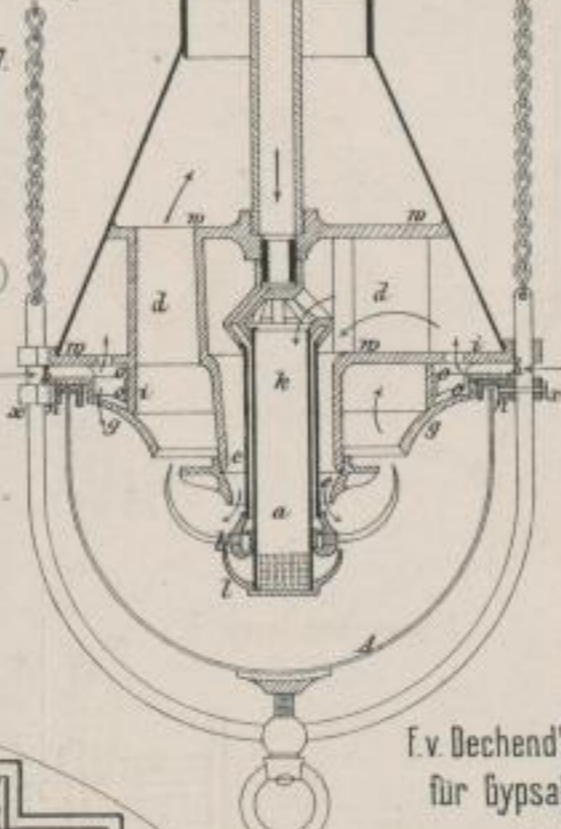

Shaw's Geschütz-Manometer. (9 u. 10)

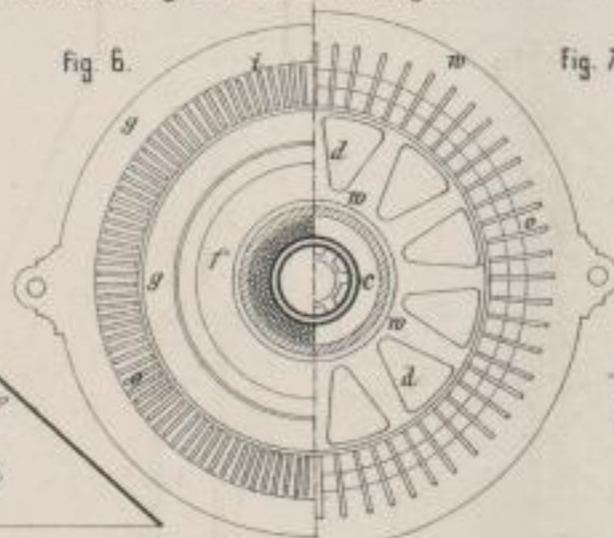
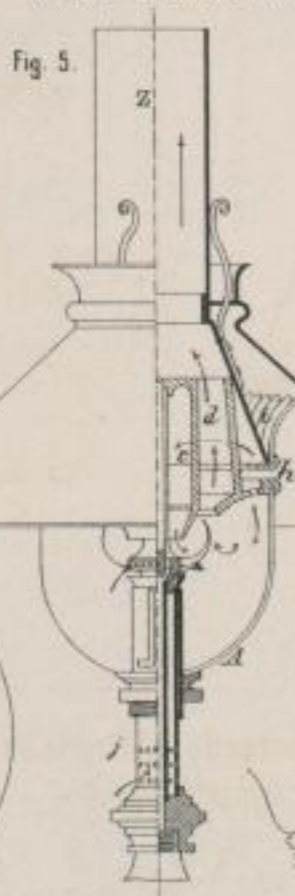
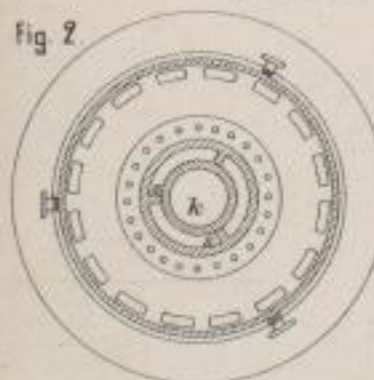
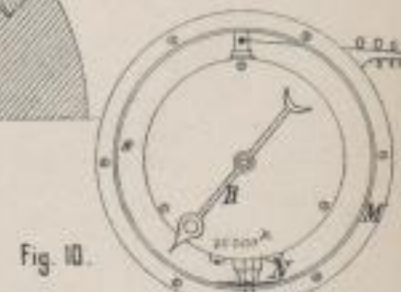
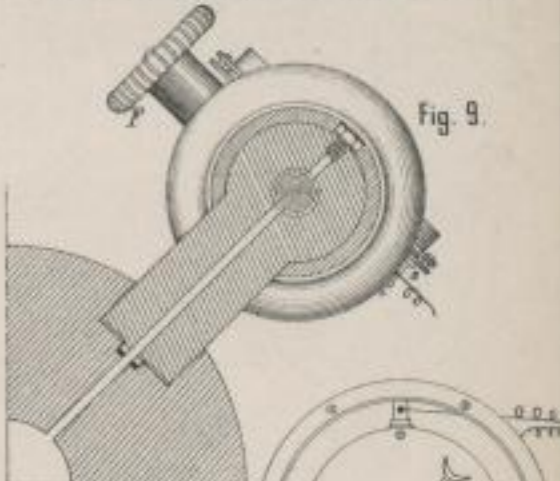

A. Bower und Thorp. (5-7)

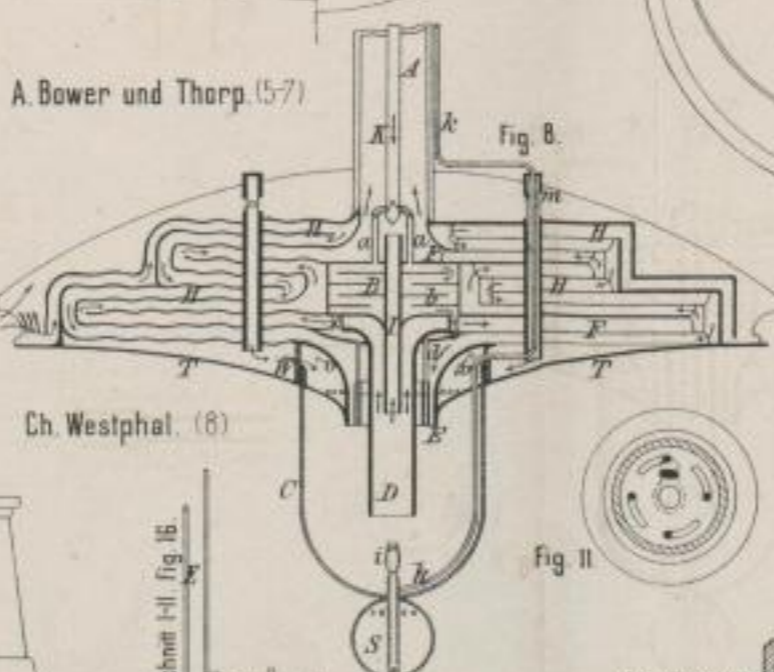

F. v. Dechend's Härtverfahren für Gypsabgüsse. (11-13)

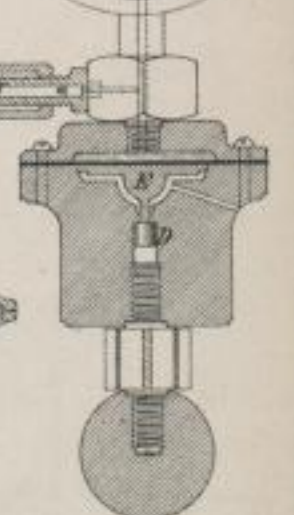
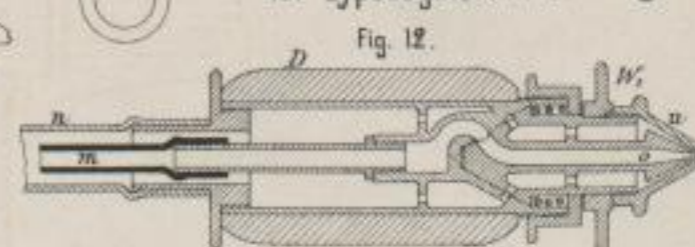

J. Efsberger. (2-4)

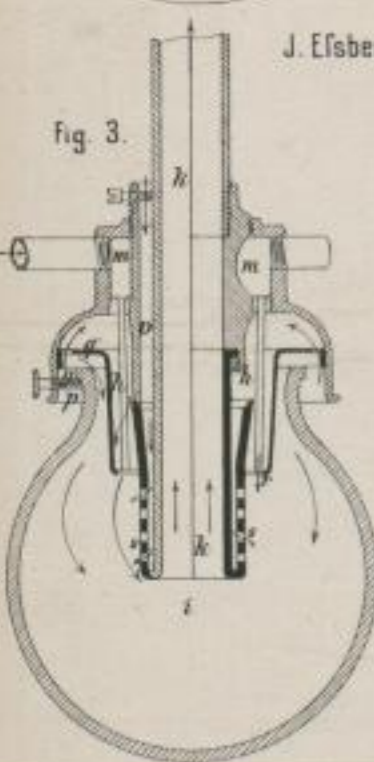

Ch. Westphal. (8)

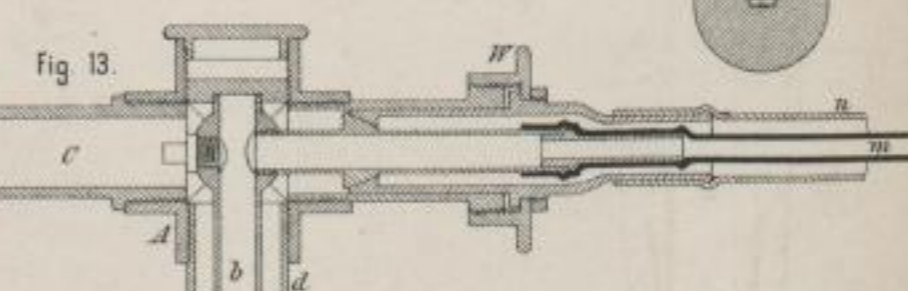
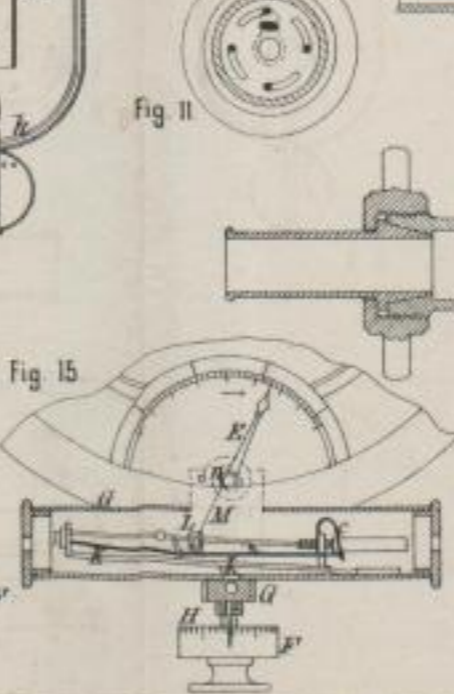
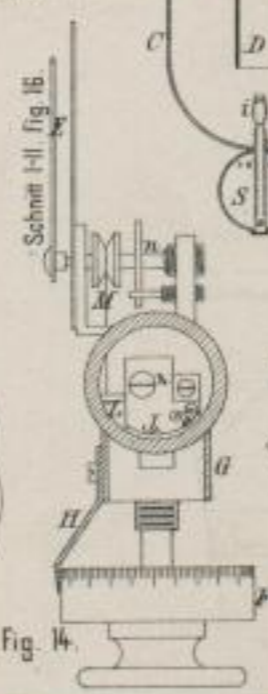
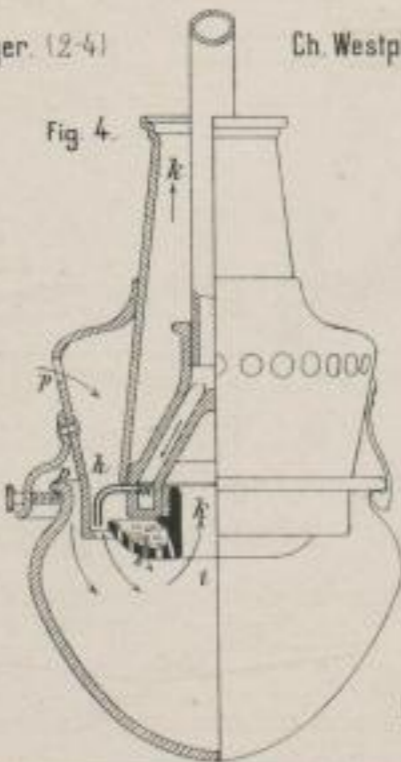

W. Riedel's Haarhygrometer. (14-16)

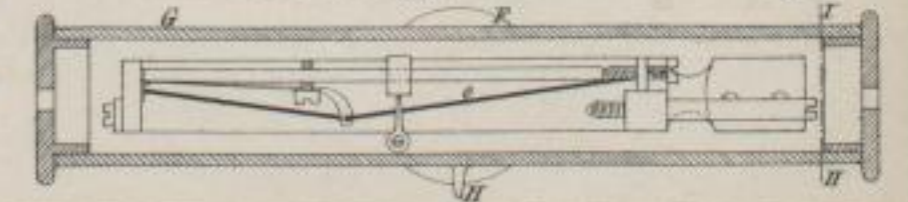

Lith. Anst. v. F. W. Tarnstadt